

TRITON *Le*

MUSIC WORKSTATION

Basic Guide

Please read this guide first

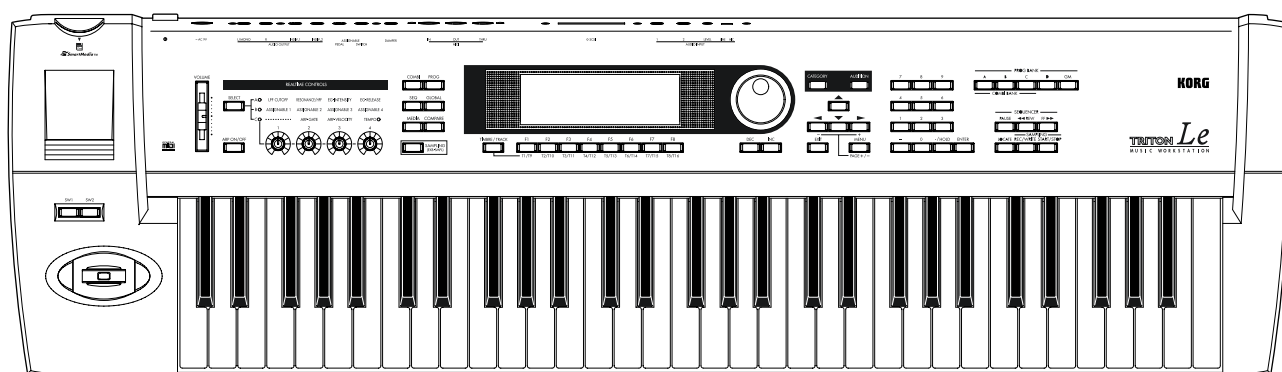

KORG

To ensure long, trouble-free operation, please read this manual carefully.

Precautions

Location

Using the unit in the following locations can result in a malfunction.

- In direct sunlight
- Locations of extreme temperature or humidity
- Excessively dusty or dirty locations
- Locations of excessive vibration

Power supply

Please connect the designated AC/AC power supply to an AC outlet of the correct voltage. Do not connect it to an AC outlet of voltage other than that for which your unit is intended.

Interference with other electrical devices

This product contains a microcomputer. Radios and televisions placed nearby may experience reception interference. Operate this unit at a suitable distance from radios and televisions.

Handling

To avoid breakage, do not apply excessive force to the switches or controls.

Care

If the exterior becomes dirty, wipe it with a clean, dry cloth. Do not use liquid cleaners such as benzene or thinner, or cleaning compounds or flammable polishes.

Keep this manual

After reading this manual, please keep it for later reference.

Keeping foreign matter out of your equipment

- Never set any container with liquid in it near this equipment. If liquid gets into the equipment, it could cause a breakdown, fire, or electrical shock.
- Be careful not to let metal objects get into the equipment. If something does slip into the equipment, unplug the AC/AC power supply from the wall outlet. Then contact your nearest Korg dealer or the store where the equipment was purchased.

THE FCC REGULATION WARNING (for U.S.A.)

This equipment has been tested and found to comply with the limits for a Class B digital device, pursuant to Part 15 of the FCC Rules. These limits are designed to provide reasonable protection against harmful interference in a residential installation. This equipment generates, uses, and can radiate radio frequency energy and, if not installed and used in accordance with the instructions, may cause harmful interference to radio communications. However, there is no guarantee that interference will not occur in a particular installation. If this equipment does cause harmful interference to radio or television reception, which can be determined by turning the equipment off and on, the user is encouraged to try to correct the interference by one or more of the following measures:

- Reorient or relocate the receiving antenna.
- Increase the separation between the equipment and receiver.
- Connect the equipment into an outlet on a circuit different from that to which the receiver is connected.
- Consult the dealer or an experienced radio/TV technician for help.

Unauthorized changes or modification to this system can void the user's authority to operate this equipment.

CE mark for European Harmonized Standards

CE mark which is attached to our company's products of AC mains operated apparatus until December 31, 1996 means it conforms to EMC Directive (89/336/EEC) and CE mark Directive (93/68/EEC). And, CE mark which is attached after January 1, 1997 means it conforms to EMC Directive (89/336/EEC), CE mark Directive (93/68/EEC) and Low Voltage Directive (73/23/EEC).

Also, CE mark which is attached to our company's products of Battery operated apparatus means it conforms to EMC Directive (89/336/EEC) and CE mark Directive (93/68/EEC).

Data handling

Malfunctions due to incorrect operation may cause the contents of memory to be lost, so we recommend that you save important data on the external media (SmartMedia etc.). Please be aware that Korg will accept no responsibility for any damages which may result from loss of data.

About copyright

This device is intended for use with material of which you yourself are the copyright owner or for which you have received permission from the copyright owner to duplicate. If you are not the copyright owner or have not received permission from the copyright owner to duplicate the material, you are in violation of copyright law, and may be liable for damages and penalties. If you are unsure of your rights to the material, please consult a legal specialist.

* SmartMedia™ is a registered trademark of Toshiba Corporation.

* Company names, product names, and names of formats etc. are the trademarks or registered trademarks of their respective owners.

Thank you for purchasing the **Korg** TRITON *Le* music workstation.
To ensure trouble-free enjoyment, please read this manual carefully and use the instrument as directed.

About this manual

The owner's manuals and how to use them

The TRITON Le come with the following owner's manuals.

- Basic Guide
- Parameter Guide
- Voice Name List

Basic Guide

First read this manual carefully to gain a basic understanding of the instrument and to learn basic operation.

"Introduction" explains the function of each part, how to make connections, basic operation, and gives an overview of each mode.

"Quick Start" explains basic topics (selecting sounds, convenient functions for performance). If you wish to begin playing immediately, read this section first.

"Basic Functions" contains mode-by-mode explanations of what you need to know to edit sounds, record on the sequencer, and record samples (If the separately sold EXB-SMPL option is installed). This section also explains how to use the arpeggiator, effects.

"Appendices" contains information on troubleshooting, specifications, and various other information.

Parameter Guide

The Parameter Guide contains explanations and other information regarding the operations of the parameters and settings on the TRITON Le. The explanations are organized by mode, and page. Explanations and other information on the effects and their parameters are also provided for each effect.

Refer to this guide when an unfamiliar parameter appears in the display, or when you need to know more about a particular function.

Voice Name List

This lists the multisamples and drumsamples that are built into the TRITON Le, and the factory preset combinations, programs, drum kits, and user arpeggio patterns.

Refer to these lists when you wish to know more about the preloaded sounds.

Conventions in this manual

References to the TRITON Le

The TRITON Le is available in 76-key and 61-key models, but both models are referred to without distinction in this manual as "the TRITON Le." Illustrations of the front and rear panels in this manual show the 61-key model, but the illustrations apply equally to the 76-key model.

Abbreviations for the manuals BG, PG, VNL

References to the manuals included with the TRITON Le are abbreviated as follows in this document.

BG: Basic Guide

PG: Parameter Guide

VNL: Voice Name List

Switches and knobs []

References to the switches, dials, and knobs on the panel are enclosed in square brackets [].

Parameters in the LCD display screen " "

Parameters displayed in the LCD screen are enclosed in double quotation marks " ".

Boldface type

Parameter values are printed in boldface type.

Content that is of particular importance is also printed in boldface type.

Procedure steps ① ② ③ ...

Steps in a procedure are listed as ① ② ③ ...

p. ■, PG p. ■

These symbols indicate a reference page number in the Basic Guide or in the Parameter Guide.

Symbols , ,

These symbols respectively indicate cautions, advice, and MIDI-related explanations.

Example screen displays

The values of the parameters shown in the example screens of this manual are only for explanatory purposes, and may not necessary match the values that appear in the LCD screen of your instrument.

MIDI-related explanations

CC# is an abbreviation for Control Change Number.

In explanations of MIDI messages, **numbers in square brackets** [] always indicate hexadecimal numbers.

Table of Contents

Introduction	1	Selecting and playing a program.....	20
Overview	1	Selecting a program.....	20
Main features	1	Selecting and playing a combination	22
Overview of the modes	3	Selecting a combination	22
Front and rear panel	5	Using controllers to modify the sound	23
Front panel.....	5	Joystick	23
Rear panel	8	SW1, SW2.....	23
Objects and functions in the		REALTIME CONTROLS [1], [2], [3],	
LCD screen	10	[4].....	24
Connections	12	Keyboard	25
Connecting audio equipment etc.....	12	Foot pedals.....	25
1. Connecting the AC/AC power supply.....	12	Using the arpeggiator while you	
2. Connecting audio output devices	12	play	26
3. Connecting pedals etc.....	13	Using the arpeggiator in	
Connections to MIDI equipment/		Program mode.....	26
computers (MIDI connectors).....	13	Settings using controllers	26
1. Connections to MIDI equipment.....	13	Settings in the LCD screen.....	27
2. Connections to a computer	13	Using the arpeggiator as you play in	
Connecting separately sold options.....	13	Combination mode.....	28
1. Audio input connections	13	Settings in the LCD screen.....	28
2. SCSI connections.....	13	Playing with the RPPR (Realtime Pattern	
Basic operation	14	Play/Recording) function	30
Selecting modes, pages and tabs; setting		Simple program editing.....	31
parameters.....	14	Performance Edit.....	31
1. Selecting modes	14	Realtime controls.....	31
2. Selecting pages and tabs.....	14	Simple combination editing	32
3. Selecting parameters	15	An example of editing.....	32
4. Setting a parameter	15	Sampling (recording a sample)	34
Quick Start	17	Sampling a sound and playing it back as	
Turning the power on/off	17	"one-shot"	34
1. Turning the power on.....	17	Using the insert effect while you	
2. Turning the power off	17	sample	35
Listening to a demo song	18	Assigning a name to the sample or	
Loading demo playback data.....	18	multisample	36
Selecting and playing a demo song in the		Saving sample data	37
Sequencer mode.....	18	Converting a multisample into a	
Playing a cue list	19	program	37
		Sampling and looping a drum	
		phrase.....	38

Basic functions	41	Sequencer mode.....	61
Saving data.....	41	Features of the sequencer	61
Types of data that can be saved	41	The structure of Sequencer mode.....	62
Writing to internal memory	42	Songs	62
Writing a program or combination	42	Patterns	62
Writing global settings, user drum kits, and		Cue List.....	62
user arpeggio patterns.....	44	Producing a song	63
Saving on external media.....	45	Creating the basic song	63
MIDI data dump.....	46	Song editing methods.....	69
Restoring the factory settings.....	47	Creating and playing a Cue List	71
Loading the preloaded data	47	Creating and recording RPPR (Realtime	
Program mode	48	Pattern Play/Record)	73
How a program is organized.....	48	Creating RPPR data	73
Basic program editing	48	RPPR playback	74
Oscillator settings.....	49	Realtime-recording an RPPR	
Controller settings	50	performance	74
Pitch settings.....	50	Recording the sounds of a	
Filter settings	51	combination	75
Amplifier settings	53	Caution and other functions in Sequencer	
LFO settings.....	54	mode	77
Arpeggiator settings.....	54	Recording on the TRITON Le.....	78
BUS settings.....	54	Recording a track,	
Insert Effect settings	54	and recording a pattern.....	78
Master Effect settings	54	Sampling mode	82
More about Alternate Modulation	55	Features of EXB-SMPL.....	82
Combination mode	56	How Sampling mode is organized.....	83
How a combination is organized	56	In Sampling mode.....	83
Basic combination editing.....	56	Samples and Multisamples.....	83
Timbre 1–8 program, pan and volume.....	57	Sampling	84
Controller settings	58	Preparations for sampling	84
Settings for status, MIDI channel, and		Manual sampling	85
playing mode.....	58	Auto sampling	86
Note timing and scale settings.....	59	Creating multisample indexes and sampling	
Layer and split settings.....	59	87	
Velocity switch settings	60	Loop settings	88
MIDI filter settings.....	60	The grid display	88
Arpeggiator settings.....	60	Sample (waveform data) editing	89
Bus settings.....	60	Multisample editing	90
Insert Effect settings	60	Editing the indices	90
Master Effect settings	60	Modifying the settings of an index.....	90
		Converting a multisample to a	
		program	91
		Using Time Slice to divide a sample, and	
		playing it in Sequencer mode.....	91

Global mode	93	Other functions	113	
Creating a drum kit	93	Tuning to another instrument/Transposing	113	
About drum kits	93	Bypassing the effects	113	
Editing a drum kit	94	Specifying the function of the Assignable	Switch and Assignable Pedal	113
Media mode	96	Selecting different Velocity and Aftertouch	curves.....	114
How Media mode is organized	96	Creating original scales	114	
Media that can be used.....	96	Changing the scale.....	114	
Formatting media	96	Setting the function of [SW1] and	[SW2]	115
Caution when handling SmartMedia	96	Setting the B-mode functions of REALTIME	CONTROLS [1]–[4]	115
Loading data	97	Adjusting the contrast (brightness) of the	LCD screen	116
Types of data that can be loaded.....	97	Using this instrument as a data filer ..	116	
Data loading procedure.....	97	Shortcuts	116	
Saving data	98			
Types of data that can be saved	98			
Arpeggiator settings	99	Appendices	117	
Arpeggiator settings for a program	99	Troubleshooting	117	
Arpeggiator on/off	99	Specifications and options	120	
Arpeggiator settings.....	99	Specifications	120	
Linking the arpeggiator to a program....	101	Options	121	
Arpeggiator settings in Combination and		MIDI Implementation Chart	122	
Sequencer modes	101	Index	123	
Arpeggiator on/off	101			
Arpeggiator settings.....	101			
Linking the arpeggiator to the				
combination.....	102			
Creating an user arpeggio pattern	103			
About user arpeggio patterns.....	103			
Editing a user arpeggio pattern.....	103			
Dual arpeggiator editing	106			
Synchronizing the arpeggiator	107			
Synchronization between arpeggiators A				
and B.....	107			
Synchronization between the arpeggiators				
and sequencer in Sequencer mode.....	107			
Synchronization with an external sequencer				
in Program, Combination, or Sequencer				
modes	107			
Effects settings	108			
Effects in each mode	108			
Routing settings and effect settings	108			
Effect settings for a program.....	108			
Effect settings in combination, and song				
110				
Effect settings in Sampling mode (requires				
the EXB-SMPL option)	110			
Effect settings for the AUDIO INPUT				
(required the EXB-SMPL option)	111			
About dynamic modulation (Dmod) ...	111			

Introduction

Overview

Main features

Overview

The TRITON Le is a music workstation featuring the HI (Hyper Integrated) synthesis system.

It contains high-quality preset multisamples/programs/combinations, an effect section, plus a sequencer, dual polyphonic arpeggiator, RPPR, four-channel audio output, and numerous other functionality.

Controllers such as the joystick, [SW1] and [SW2] keys, REALTIME CONTROLS [1]–[4] knobs, or connected pedals can be used to control filter or effects, allowing you to modify the sound in realtime as you perform. Arpeggiator gate or velocity, or the tempo of the arpeggiator or sequencer can also be controlled.

In addition, the optional **EXB-SMPL sampling upgrade** can be installed to add two-channel audio input and sampling functionality. (see p.34, 84, see PG p.253)

The TRITON Le is the ideal music workstation for music production or live performance.

HI (Hyper Integrated) synthesis system

The **HI (Hyper Integrated) synthesis system** is a PCM tone generator system with full digital signal processing that guarantees pristine sound, and features enormous flexibility in musical extensibility, modulation, and effect routing.

Tone generator section:

- **32 Mbytes** of preset PCM ROM contains **425** multisamples and **413** drumsamples.
- The sampling frequency is **48 kHz**, and the maximum polyphony is **62 voices**.

Filter/synthesis section:

- **24 dB/oct Low Pass Resonance type** or **12 dB/oct Low Pass & High Pass type** filters can be used. A wide variety of filter effects can be achieved, from active sounds with aggressive resonance to subtle tones using a high pass filter.
- A broad range of editing parameters gives you control over every aspect of the sound.

Effect section:

- **One insertion effect (stereo-in/stereo-out), two master effects (mono-in/stereo-out), and a three-band master EQ (stereo-in/stereo-out)** can all be used simultaneously. You can select from **89 types** of effect algorithms, and edit them.
- Highly flexible effect routing is possible. Effects can also be routed freely to the individual outputs.

Alternate Modulation and Effect Dynamic Modulation:

- The synthesis section (filter etc.) provides **Alternate Modulation functionality**, and the effect section provides **Effect Dynamic Modulation functionality**. This allows you to freely apply modulation to parameters that affect the pitch, filter, amp, EG, LFO, effects etc.
- LFO and delay time parameters can be synchronized to MIDI clock/tempo. You can synchronize sounds or effects to the tempo of the sequencer or the arpeggiator.

Programs and combinations

- In the Program mode, the TRITON Le provides 512 user programs, and 128 programs + 9 drum sets for GM compatibility. When shipped from the factory, it contains high-quality preload programs that cover a wide range of musical needs. The 512 user programs can be modified by adjusting the numerous editing parameters, the effects and the arpeggiator, to create your own original programs.
- The TRITON Le provides 24 user drum kits and nine GM2-compatible ROM drum kits. With the factory settings, preset drum kits that cover a variety of musical genres are provided. You can create your own original drum kits by assigning a drumsample or an original sampled sound to each note of the keyboard. For each note, you can make filter and amp settings, and even route the sound through effects and to a individual audio output.
- The TRITON Le provides 384 user combinations. The factory settings contain a wide variety of Preload combinations. A combination allows you to use layers, splits, or velocity switches etc. to combine up to eight programs together with effects and two arpeggiators, in order to create complex sounds that could not be produced by a program. You can also make settings that include external tone generators.

Sequencer

TRITON Le provides a **high-performance 16-track MIDI sequencer**, with more than sufficient power for use as a stand-alone sequencer. The sequencer can serve as the core that brings together TRITON Le's numerous capabilities, allowing it to serve as an integrated music workstation.

For more on TRITON Le's sequencer (see p.61).

RPPR

TRITON Le features a **RPPR (Realtime Pattern Play/Recording) function**.

In Sequencer mode, this function allows you to assign preset patterns or user patterns (with a specified playback track) to individual keys on the keyboard, and playback or record that pattern in realtime simply by pressing the assigned key. Numerous preset patterns, including patterns ideal for drum tracks, are built into the internal memory.

Dual polyphonic arpeggiator

- Five preset arpeggio patterns (UP, DOWN, ALT1 ALT2, RANDOM) and 216 user arpeggio patterns are provided. With the factory settings, these contain a wide variety of preset user patterns. In addition to providing conventional arpeggiator functionality, the polyphonic arpeggiator of the TRITON Le can respond to the pitches or timing at which you play the keyboard, and produce a diverse range of chords or phrases. This can be used to play a variety of drum phrases (using the "Fixed Note Mode" that is ideal for drums), bass phrases, or guitar and keyboard backing riffs. The arpeggiator is also effective for use with subtly moving pads, synth sounds, or sound effects.

In Combination mode, and Sequencer mode, the TRITON Le provides dual arpeggiators that can simultaneously play two arpeggio patterns. You can apply separate arpeggio patterns to drum and bass programs, or use keyboard splits or velocity to switch between arpeggio patterns for an even more dynamic performance.

4 channel audio output

- In addition to the L/MONO and R main stereo **audio outputs**, TRITON Le provides **two individual audio outputs**, for a total of four channels of audio output. The sound from each oscillator, drum, timbre/track, or insertion effect can be routed freely to any output.

EXB-SMPL sampling upgrade

The following functionality can be added by installing the separately sold EXB-SMPL option.

- Sampling mode is added. Input sources from the two-channel audio inputs can be sampled and edited to create original multisamples or samples, which can then be used in a program or drum kit. For details on the features of Sampling mode, refer to p.82.
- Two-channel audio input is added. This two-channel audio input allows 48 kHz 16 bit linear mono/stereo sampling. A MIC or LINE level select switch and level adjustment control supports a wide range of external audio sources, from mic level to line level. The audio input can also be routed to the effects. You can apply an effect while sampling, or use the TRITON Le as a 2-in/4-out effect processor.
- A SCSI connector is added, allowing external SCSI devices such as hard disks to be connected. A connected external SCSI device can be used in the same way as SmartMedia to save or load data.

Overview of the modes

The TRITON Le has a large number of functions that let you play and edit programs and combinations, record and play sequence data, and manage data on media. The largest unit used to organize these functions is called a mode. The TRITON Le has five modes.

If the separately sold EXB-SMPL option is installed, Sampling mode will be added (a total of six modes), and you will be able to record and edit samples.

Program mode

- Select and play programs
 - You can choose programs from rewritable banks A, B, C, and D which contain a total of 512 programs, and non-rewritable bank G (128 programs compatible with the GM standard, and nine drum programs).
- Edit a program
 - Make settings for the oscillator, filter, amp, EG, LFO, effects, and arpeggiator.
 - Select a multisample (the following multisamples are available)
 - 425 internal multisamples (ROM)
 - Multisamples (RAM) created in Sampling mode (if the separately sold EXB-SMPL option is installed)

- Create drum programs using a drum kit (created in Global mode)

Combination mode

- Select and play combinations
 - A combination is a set of two or more programs (a maximum of eight), and allows you to produce complex sounds that could not be created by an individual program.
 - You can choose combinations from rewritable banks A, B, and C which contain a total of 384 combinations.
- Edit a combination
 - Make settings for volume, pan, layer/split etc. for each timbre (program), and make settings for effects and the two arpeggiators etc.

Sequencer mode

- Use the 16-track sequencer to record and playback songs.
- Make effect settings for the song.
- You can record a performance using the arpeggiator(s) into a song or pattern.
- You can use a cue list to set up consecutive playback of multiple songs, and specify the number of repeats for each song.

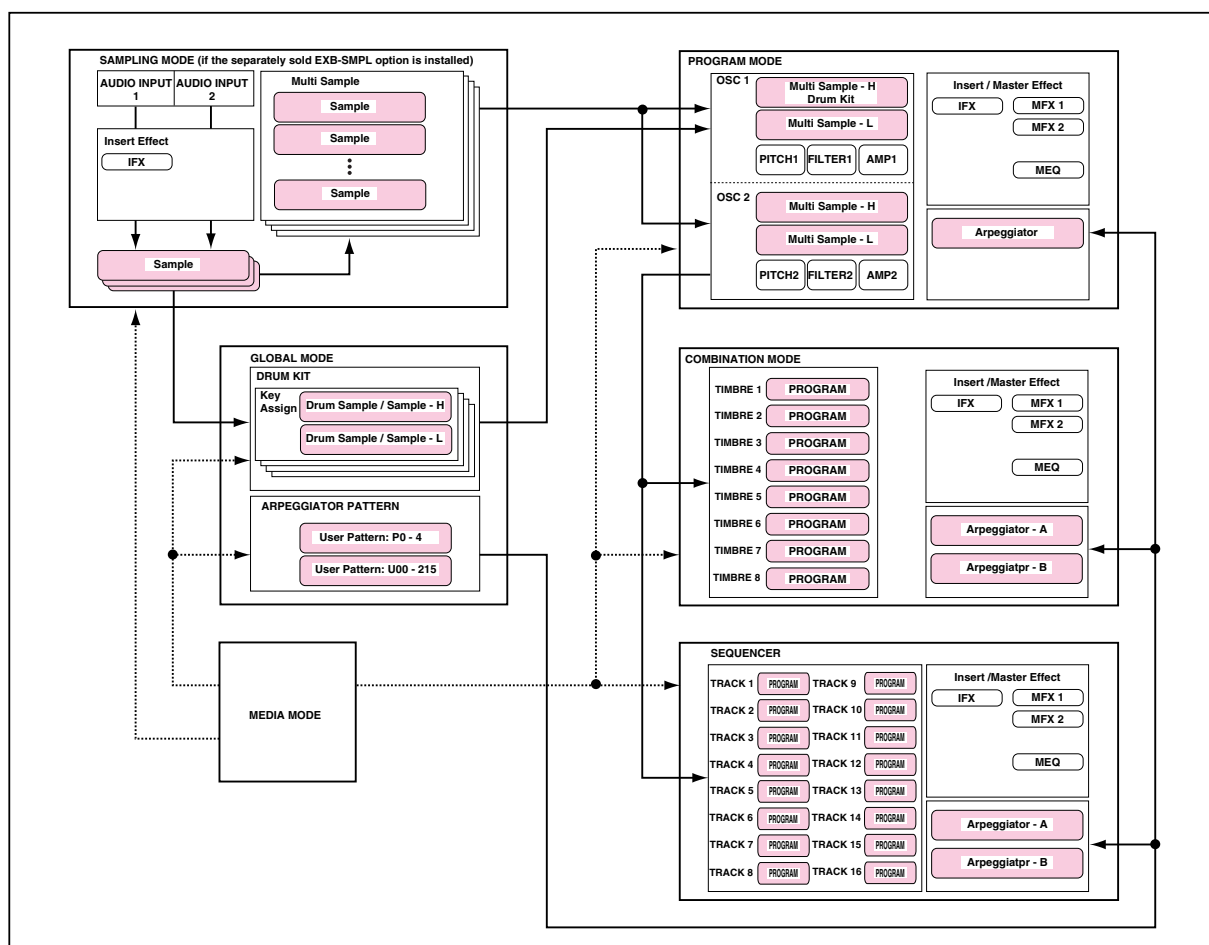

-
- You can use a maximum of 20 cue lists, 200 songs, and 150 preset patterns. One song can use as many as 100 patterns.
 - The TRITON Le can be used as a 16-track multitimbral tone generator.
 - Create and playback patterns in realtime, using the RPPR (Realtime Pattern Play/Recording) function.

Global mode

- Make settings that affect the entire TRITON Le, such as master tune and global MIDI channel.
- Create drum kits (24 kits), user arpeggio patterns (216 patterns), and user scales (16 one-octave scales and 1 all-note scale).
- Create drum kits using the 413 internal drum samples (ROM). You can also use samples (RAM) that were created in Sampling mode (requires the separately sold EXB-SMPL option).
- Set the function of the assignable pedals and assignable switches.
- Transmit data dumps of MIDI exclusive data.
- Adjust the input level from AUDIO INPUT 1 and 2 (if the EXB-SMPL option is installed). This setting is valid outside of Sampling mode. The internal effects can be applied to the external input sound. The settings for Sampling mode are made independently in Sampling mode itself.

Media mode

- Data of each mode can be saved and loaded using the SmartMedia slot or an external SCSI device (if the separately sold EXB-SMPL option is installed).
- Media such as SmartMedia or hard disks (EXB-SMPL option required) can be formatted, and data can be managed by copying etc.
- Korg format, AKAI, AIFF, and WAVE format sample data can be loaded. Sample data can also be saved in Korg format, or exported in AIFF or WAVE formats. (if the separately sold EXB-SMPL option is installed)
- Songs that you created in Sequencer mode can be saved in SMF format. SMF files can be loaded as Sequencer mode songs.
- You can use the Data Filer function (to save/load MIDI exclusive data).

Sampling mode

(if the EXB-SMPL option is installed)

- An external audio device or mic connected to the rear panel AUDIO INPUT jacks can be sampled (recorded as a sample). An insert effect can also be applied to the select input sound while it is being sampled.
- Waveform data that was sampled or loaded in Media mode can be modified using a variety of editing functions, such as adjusting the loop point, using Time Slice, or Time Stretch.
- You can edit multisamples (which consist of multiple samples).
- You can convert a multisample into a program. When this conversion is performed, a multisample created in Sampling mode can be used in Program, Combination, and Sequencer modes.

Front and rear panel

Front panel

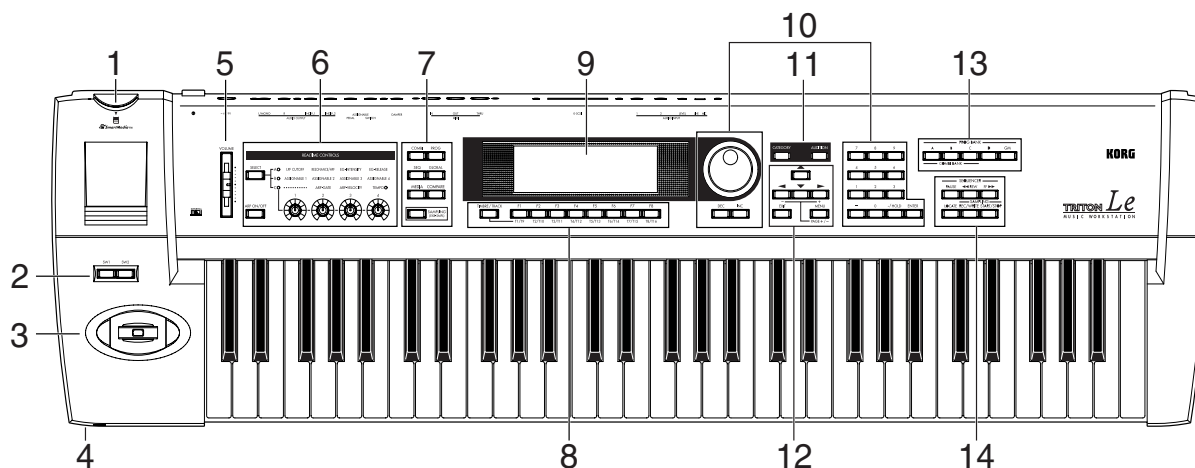

1. SmartMedia slot

SmartMedia cards can be inserted here, allowing you to save or load data or song data or other types of data you edited.

For details on handling SmartMedia, refer to “Caution when handling SmartMedia” (p.96).

2. [SW1] key, [SW2] key

These keys are on/off switches for the functions to which they were assigned in Program, Combination, Sequencer and Sampling modes (if the EXB-SMPL option is installed). When on, the key will light (p.23).

3. Joystick

This controls pitch or modulation, etc.

Move the joystick up/down or left/right (+Y, -Y, -X, +X) to control (p.23).

Various program parameters and effect parameters will determine what is controlled by the joystick.

4. Headphone jack

A set of headphones with (1/4") stereo phono plug can be connected here.

The output from the L/MONO and R OUTPUT jacks can be monitored in stereo through the headphones.

5. [VOLUME] slider

This adjusts the volume that is output from the OUTPUT jacks (L/MONO, R) and the headphone jack.

6. REALTIME CONTROLS

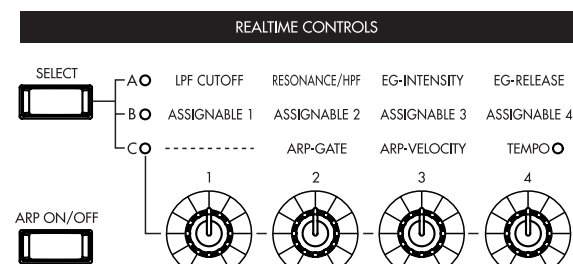

Use the [SELECT] key to select realtime controller mode A/B/C, and use knobs [1]-[4] to control the tone, effects, MIDI control changes, and arpeggiator etc. while you perform. (p.24, 26)

[SELECT] key

This key switches the realtime controller between A-mode, B-mode, and C-mode. The LED of the selected mode will light.

[ARP ON/OFF] key

This key turns the arpeggiator on/off. When on, the key will light.

[1], [2], [3], [4] knob

A-mode

[1] LPF CUTOFF:

Controls the cutoff frequency of the low pass filter.

[2] RESONANCE/HPF:

Controls the filter resonance level or the high pass filter cutoff frequency.

[3] EG-INTENSITY:

Controls the filter EG intensity.

[4] EG-RELEASE:

Controls the filter/amp release time.

B-mode

[1] ASSIGNABLE 1:

[2] ASSIGNABLE 2:

[3] ASSIGNABLE 3:

[4] ASSIGNABLE 4:

Controls the functions that are assigned in each mode (Program, Combination, Sequencer, or Sampling (if the EXB-SMPL option is installed)).

C-mode

[1] ———: not used

[2] ARP-GATE:

Controls the gate time (note duration) of the arpeggiated notes. At the center position (12 o'clock), the setting of the arpeggiator "Gate" parameter will be used. Rotating the knob toward the left will shorten the time, and rotating it toward the right will lengthen the time.

[3] ARP-VELOCITY:

Controls the velocity (playing strength) of the arpeggiated notes. At the center position (12 o'clock), the setting of the arpeggiator "Velocity" parameter will be used. Rotating the knob toward the left will weaken the velocity, and rotating it toward the right will strengthen the velocity.

[4] TEMPO:

Controls the tempo of the arpeggiator or of the Sequencer mode.

The LED beside "TEMPO" will blink at quarter note intervals of the specified tempo.

7. Mode keys, [COMPARE] key

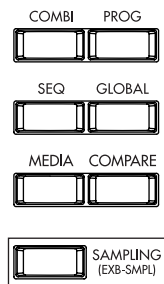

These keys are used to enter each mode. Pressing a key will enter the corresponding mode (the key will light). (p.14)

[COMBI] key

Combination mode will be selected.

[PROG] key

Program mode will be selected.

[SEQ] key

Sequencer mode will be selected.

[GLOBAL] key

Global mode will be selected

[MEDIA] key

Media mode will be selected.

[COMPARE] key

Use this key when you wish to compare the sound of the program or combination that you are currently editing with the un-edited sound that was written into memory. You can also use this key to make "before and after" comparisons when recording or editing in Sequencer mode (p.15).

[SAMPLING] (EXB-SMPL) key

This key selects the Sampling mode.

This is valid only if the separately sold EXB-SMPL option is installed.

▲ If the separately sold EXB-SMPL option is not installed, pressing the [SAMPLING] key will cause a message of "No Sampling Upgrade Installed" to be displayed.

8. [TIMBRE/TRACK] key, [F1 T1/T9] ... [F8 T8/T16] keys

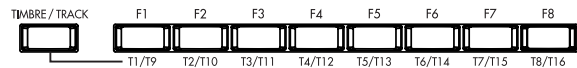

Function [F1]–[F8] keys

These keys select the tabs that are displayed in each page. They are also used to execute utilities and other functions.

Timbre/track select [T1/T9]–[T8/T16] keys

By holding down the [TIMBRE/TRACK] key and pressing a [T1/T9]–[T8/T16] key, you can select the timbre/track parameters corresponding to the key number.

When a single page displays the parameters for timbres 1–8 of a Combination or for tracks 1–8/9–16 of Sequencer mode, these keys select one of these timbres/tracks.

9. LCD screen

Here you can select pages, and parameters, and set values. (p.10)

10. VALUE controllers

The following VALUE controllers are used to set the value of the selected parameter (p.15).

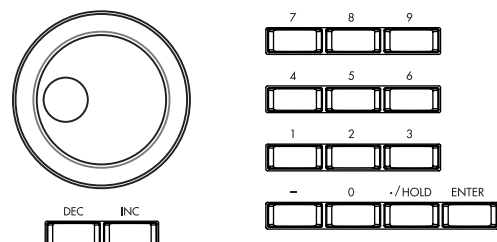

[VALUE] dial

Use this dial to modify the value of the parameter.

[INC]/[DEC] keys

These are used to increase or decrease the parameter value in steps of one. It is convenient to use these to make fine adjustments.

Numeric keys [0] – [9], [ENTER] key, [-] key, [./HOLD] key

Use these keys to numerically input a parameter value. Use numeric keys [0]–[9], the [-] key, and the [./HOLD] key to enter the value, and press the [ENTER] key to confirm it. The [./HOLD] key lets you input a value with a decimal point. The [-] key inverts the sign (+/-) of the parameter value.

In addition, [./HOLD] can be used if you wish to select sounds by category in program or combination mode.

By holding down the [ENTER] key and pressing a numeric key [0]–[9], you can select up to ten utility menu commands for the current page.

11. [CATEGORY] key, [AUDITION] key**[CATEGORY] key**

In each mode, you can directly access the utility menu “Select by Category” by choosing a parameter that can be selected by category and then pressing the [Category] key.

This allows you to view and select programs or combinations by category. (p.21)

[AUDITION] key

This key activates the **Audition function**, which plays a riff (phrase) suitable for each preloaded or preset program.

In Program mode, pressing the [AUDITION] key (the key will light) will cause the audition riff to play repeatedly.

In Sampling mode (if the EXB-SMPL option is installed), the selected sample will be played.

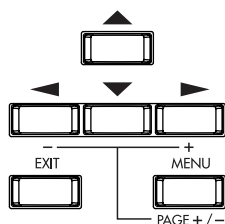
12. [EXIT] key, [MENU PAGE +/-] key, CURSOR keys [▲], [◀-], [▼], [▶+]**[EXIT] key**

In Program, Combination, Sequencer, Sampling (if the separately sold EXB-SMPL option is installed), and Global modes, pressing this key from anywhere other than page 1.1 will take you to page 1.1 of that mode.

When a dialog box is open, this key will cancel the settings made in the dialog box and close the dialog box (corresponds to the “Cancel”). If a Utility menu or page menu is open, pressing [EXIT] will close the menu.

[MENU PAGE +/-] key

Use this key to select different pages on screen. When you press this key, a list of the pages within the mode will appear in the LCD screen. Use the function key [F1]–[F7] or cursor keys [▲], [◀-], [▼], [▶+] to select the desired page, and press the [F8] key to move to the selected page.

You can also move to a desired page by holding down the [MENU] key and using numeric keys [1]–[7] to enter a two-digit page number.

In addition, you can hold down the [MENU] key and use cursor keys [◀-], [▶+] to switch pages in the order of 1.1→2.1→2.2→2.3. (p.14)

CURSOR keys [▲], [◀-], [▼], [▶+]

Use these keys to select different parameters on screen. In addition, you can hold down the [MENU] key and use cursor keys [◀-], [▶+] to switch pages in the order of 1.1→2.1→2.2→2.3. (p.14)

13. BANK keys

These keys are used to switch Program/Combination banks.

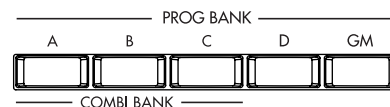
**PROG BANK: [A], [B], [C], [D], [GM]**

When selecting programs, use keys [A], [B], [C], [D], and [GM]. The key of the selected bank will light.

Each time you press [GM], you will cycle through the GM banks and the drum bank as follows: G, g(d), G ... etc.

COMBI BANK: [A], [B], [C]

When selecting combinations, use keys [A], [B], and [C]. The LED of the selected bank will light.

In **Combination**, and **Sequencer modes** when the edit cell (highlighted area) is located at the program of a timbre or track, you can use the BANK keys to select the bank of the program. The bank key of the program selected for that timbre/track will light.

In dialog boxes such as **Write Program** or **Write Combination**, these keys are used to specify the program or combination bank that will be the writing destination, etc.

14. SEQUENCER/SAMPLING

(If the separately sold EXB-SMPL option is installed)

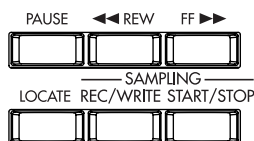

[PAUSE] key

This key pauses playback of a song or cue list (the key will light). Press the key again to cancel Pause (the key will go dark).

[◀◀ REW] key

This key rewinds playback of a song or cue list. Rewind will occur when you press the key (the key will light). (This will not operate during recording.)

[FF ▶▶] key

This key fast-forwards playback of a song or cue list. Fast-forward will occur when you press the key (the key will light). (This will not operate during recording.)

[LOCATE] key

This key resets the playback location of a song or cue list to a specified location. You can also press this key when “stuck notes” occur for some reason.

[REC/WRITE] key

When you press this key in Sequencer mode, the TRITON Le will enter recording-ready mode (the key will light). If you then press the [START/STOP] key, recording will start. (p.78)

When you press this key in Program, Combination, or Global modes, a dialog box will appear. If you then press the [F8] (“OK”) key, the edited content will be written. (p.42, 44)

When you press this key in Sampling mode (if the EXB-SMPL option is installed) and then press the [START/STOP] key, sample recording will begin. (p.34)

[START/STOP] key

In Sequencer mode, this key starts/stops song recording/playback, or cue list playback. (The key will blink in time with the beat during recording or playback.)

In Sampling mode (if the EXB-SMPL option is installed), press the [REC/WRITE] key and then press the [START/STOP] key to start/stop sample recording. In the SMPL 2.1-2: Sample Edit, Edit2 page, pressing this key will sound the sample.

Rear panel

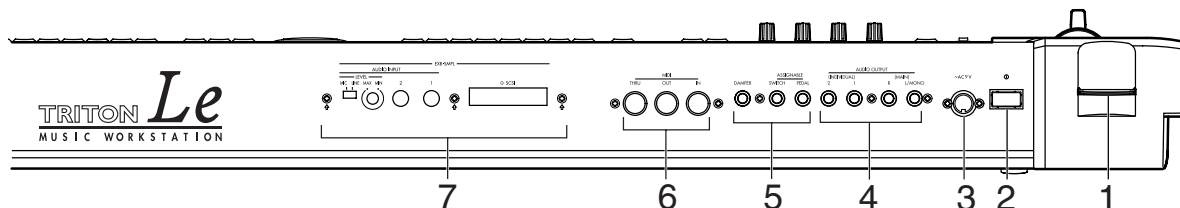

1. SmartMedia slot

SmartMedia cards can be inserted here (p.5).

2. [POWER] switch

This switch turns the power on/off (p.17).

3. AC power supply connector (~AC9V)

Connect this to the included AC/AC power supply. After connecting the power supply cable to TRITON Le, connect the other end to an AC outlet (p.12).

4. AUDIO OUTPUT

Connect these outputs to the input jacks of your amp or mixer. In addition to the L/MONO and R main stereo audio outputs, TRITON Le provides two individual audio outputs. The sound from each oscillator, drum, timbre/track, or insertion effect can be freely routed to any output (p.108-).

(MAIN) L/MONO, R

These are unbalanced phone jacks (p.12). These are the main audio output jacks. By setting “Bus

Select” to L/R, the output from an oscillator, an insertion effect, an individual drum part, or the metronome can be output to the (MAIN) L/MONO and R jacks. When making connections in stereo, use L/MONO and R. When making connections in mono, use the L/MONO jack.

(INDIVIDUAL) 1, 2

These are unbalanced phone jacks (p.12). These are individual (independent) audio output jacks. By cycling the “Bus Select” through 1, 2, 1/2 an oscillator, an insertion effect, an individual drum part, or the metronome etc. can be assigned to be output from the (INDIVIDUAL) 1, 2 jacks. The output from the 1, 2 jacks is not affected by the [VOLUME] slider.

5. Pedal connections

ASSIGNABLE PEDAL jack

The separately sold Korg XVP-10 EXP/VOL pedal or EXP-2 foot controller (options) can be connected to this jack. (p.13).

Its function can be assigned in Global mode, allowing

you to use the pedal to control the volume, etc. (p.113)

ASSIGNABLE SWITCH jack

A separately sold on/off foot switch such as the Korg PS-1 foot switch can be connected here (p.13). Its function can be assigned in Global mode, allowing you to use the foot switch as a modulation controller, to select programs or combinations, or to start/stop the sequencer (p.113).

DAMPER jack

A separately sold switch-type pedal such as the Korg DS-1H damper pedal can be connected here. If a DS-1H is connected, it will function as a half-damper pedal. In order to ensure that the half-damper pedal functions correctly, please adjust the polarity and the sensitivity (PG p.124, 126). If any other switch-type pedal is connected, it will function as a damper switch. Set the polarity according to the pedal that you connected. (PG p.126)

6. MIDI

MIDI IN connector

Musical data and sound settings etc. are received at this connector.

Use this to play TRITON Le from another connected MIDI device (PG p.231).

MIDI OUT connector

Musical data and sound settings etc. are transmitted from this connector.

Use this to control another connected MIDI device from TRITON Le (PG p.231).

MIDI THRU connector

Musical data and sound settings etc. that are received at the MIDI IN connector are re-transmitted without change from the MIDI THRU connector.

You can use this to connect multiple MIDI devices via MIDI cables (PG p.231).

7. EXB-SMPL

(If the separately sold EXB-SMPL option is installed)

These connectors are used to sample mono or stereo audio from a mic or audio device (p.34, 38), or to use the internal effect processor to apply effects. (p.111) The MIC/LINE level select switch ([MIC/LINE] switch) and the level adjustment knob ([LEVEL] knob) allow a wide range of audio sources to be input, from mic level to line level.

SCSI connector

Use a SCSI cable to connect this to a SCSI-compatible device (hard disk drive, CD-ROM drive, etc.). (EXB-SMPL owner's manual)

AUDIO INPUT 1, 2 jacks

These are unbalanced phone audio input jacks. (p.13) Connect them to the OUTPUT jack(s) of your external audio device or mic.

[LEVEL] knob

This knob adjusts the input level of the AUDIO INPUT 1, 2 jacks. (p.34)

[MIC/LINE] switch

This switch selects the input level of the AUDIO INPUT 1, 2 jacks. (p.34)

Objects and functions in the LCD screen

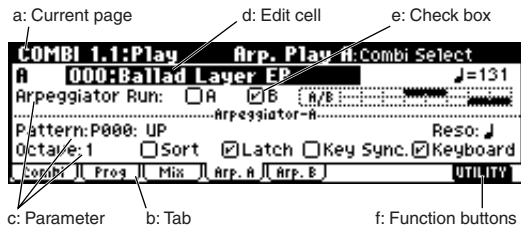

a: Current page

This indicates the currently selected page within the mode. From the left, this area shows the **mode name**, **page number:name**, **tab name**, and the **parameter name** of the edit cell.

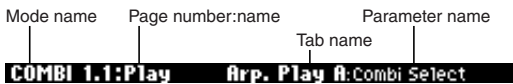

b: Tab

Most pages are divided into two or more tabs. By pressing the closest function key [F1]–[F7], you can select a tab to access the corresponding page.

c: Parameters

The parameters for various settings are displayed in the LCD screen. Use cursor keys [▲], [◀], [▼], [▶] to select the desired parameter.

d: Edit cell

When you use the cursor keys [▲], [◀], [▼], [▶], the selected **parameter** will be highlighted in the LCD screen. This area is called the **edit cell**, and your editing will affect the highlighted area. The parameter value of the edit cell can be modified using VALUE controllers such as the [VALUE] dial or the [INC]/[DEC] keys (see p.15). For parameters that accept a key number or a velocity value, you can also hold down the [ENTER] key and play a note on the keyboard to enter the key number or velocity value.

e: Check box

Use cursor keys [▲], [◀], [▼], [▶] to select a check box (edit cell), and use a VALUE controller such as the [VALUE] dial or the [INC]/[DEC] keys to add or remove the check mark. When **checked**, the parameter will function, when **unchecked**, the parameter will not function.

f: Function buttons

By pressing the function key [F1]–[F8] nearest this button, you can turn various functions on/off.

UP, OPEN:

In Media mode, these select the current directory.

UTILITY:

Accesses the utility menu where you can execute **utility menu** commands.

Other function buttons examples

Sequencer mode: EDIT/DONE, INSERT, CUT, COPY, JUMP, DONE, Tie, Rest, Back, Done (used in Cue List, Event Edit, Step Recording) REVERT (copy and paste RPPPL settings)

Global mode: TEXT, KEY+, –

Sampling mode (if the separately sold EXB-SMPL option is installed):



INSERT, CUT, COPY, CREATE (create multisample), L/R, ZOOM

* Utility menu



In each page, you can press the “UTILITY” function button (the [F8] key) to access the utility menu. The utility menu contains commands that can be used in that page. The utility menu that appears will differ depending on the page that is selected.

You can also select up to ten utility menu commands by holding down the [ENTER] key and pressing a numeric key [0]–[9]. Press the [EXIT] key to close the utility menu.



For , press the [F7] key to select the desired utility menu command. You can also use the cursor keys [▲], [◀], [▼], [▶] to make your selection. For , press the [F8] key to open the dialog box of the selected utility menu command. This key also switches the status of commands that you check or uncheck.

* Dialog boxes

When you select a utility menu command etc., a **dialog box** will open.

Use the cursor keys [**▲**], [**◀**], [**▼**], [**▶**] to select parameters. Use the VALUE controllers (p.15) to input the parameter values. When selecting program or combination numbers in a dialog box, you can use the BANK [A]–[GM] keys in addition to the VALUE controllers.

As in the utility menu, press the function key [F1]–[F8] nearest  etc. (function button 2) to access the execution or operation screen. In some cases, a dialog box will appear. Follow the directions shown in the dialog box.

To execute, select  (press the [F8] key). To cancel without executing, select  (press the [F7] key). The dialog box will close. The [EXIT] key is equivalent to “Cancel,” “Done,” or “Exit.”



* Function buttons 2

Press the function key [F1]–[F8] nearest this button to execute the function.

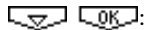

Utility menu, etc.

* Text dialog box

When you use the function keys to select  etc, a **text dialog box** will appear.

In this dialog box you can rename text (e.g., the name of a program, combination, or song). (p.43)

* Scroll bar

This indicates that the list contains selections or parameters that cannot all be shown in the screen at once. Use the cursor keys [**▲**], [**◀**], [**▼**], [**▶**] to move within the list.

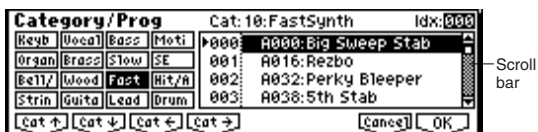

* Page menu

In Combination, Program, Sequencer, Global, or Sampling (if the separately sold EXB-SMPL option is installed) modes, pressing the [MENU] key will display a list of the pages in that mode. (The page in which you were when you pressed the [MENU] key will be highlighted.)

To select a page, press the nearest function key [F1]–[F7]. By pressing the same key you can move consecutively downward. You can also use cursor keys [**▲**], [**◀**], [**▼**], [**▶**] to move left/up/down/right.

You can also move to the desired page by holding down the [MENU] key and using numeric keys [0]–[7] to enter a two-digit page number. In addition, you can hold down the [MENU] key and use the cursor keys [**◀**], [**▶**] to move in steps of one page; in the example shown below, this would be Play → P/M → Ctrl → Prm1 → ... etc.

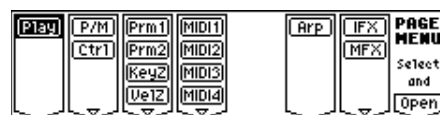

* Other objects

To use slider- or knob-shaped objects, use the cursor keys [**▲**], [**◀**], [**▼**], [**▶**] to select the desired item, and use the VALUE controllers to adjust the value.

Other types of objects are shown in the effect routing screen. (p.108)

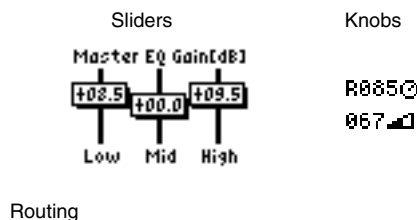

Routing

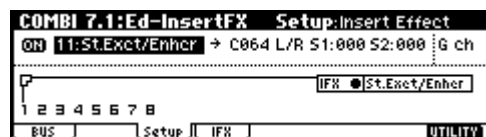

Connections

Connecting audio equipment etc.

⚡ Connections must be made with the power turned off. Please be aware that careless operation may damage your speaker system or cause malfunctions.

1. Connecting the AC/AC power supply

○ Connect the included AC/AC power supply to the AC power supply inlet of TRITON Le, and then connect the other end of the cable to an AC outlet.

2. Connecting audio output devices

AUDIO OUTPUT (MAIN) L/MONO, R, (INDIVIDUAL) 1, 2

Here, you can connect a set of amplified monitor speakers or your audio system to output TRITON Le's sound.

If you wish to use the AUDIO OUTPUT (INDIVIDUAL) 1-2 jacks of TRITON Le, we recommend that you use a mixer.

⚡ If you playback TRITON Le through your stereo audio system, be aware that high volumes may damage your speakers. Be careful not to raise the volume excessively.

○ Connect the AUDIO OUTPUT (MAIN) L/MONO and R jacks to the INPUT jacks of your powered monitor system, mixer etc.

L/MONO and R are the main outputs. If you are outputting in stereo, make connections to the (MAIN) L/MONO jack and the R jack. If you are outputting in monaural, make connections to the (MAIN) L/MONO jack. We recommend that you playback in stereo if possible.

○ If you wish to output from the AUDIO OUTPUT (INDIVIDUAL) 1, 2, jacks, connect these jacks to your mixer, and then connect the mixer output to the INPUT of your powered monitor system etc.

For details on the output of each jack (esp. 108-“Routing”).

Headphones

○ When using headphones, plug them into the headphones jack located on the front panel.

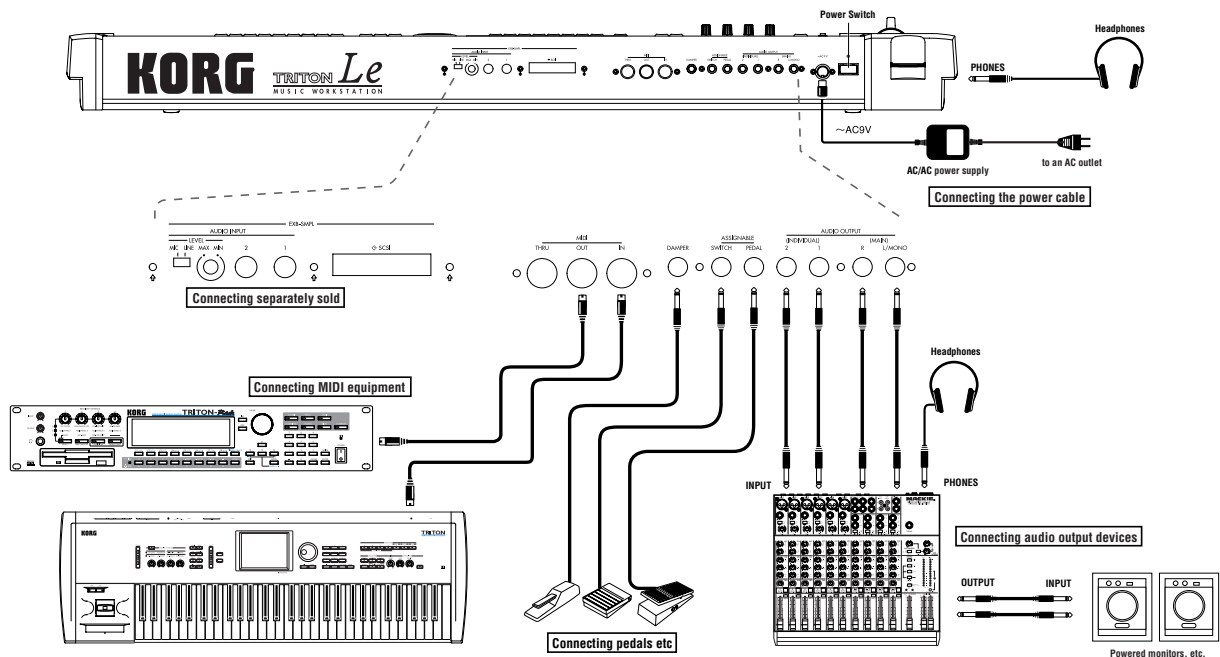

3. Connecting pedals etc.

Foot pedal connections

A foot pedal can be connected to control the volume or other functions.

Connect a separately sold Korg assignable pedal such as the XVP-10 EXP/VOL or EXP-2 to the rear panel ASSIGNABLE PEDAL jack.

The function controlled by the foot pedal is specified in GLOBAL 1.1-3: System, Foot page "Foot Pedal Assign" (PG p.113, PG p.125, 223).

Foot switch connections

A foot switch controls sostenuto, soft pedal on/off, arpeggiator on/off, to select programs or combinations, and to start/stop the sequencer etc.

Connect a separately sold Korg foot switch such as the PS-1 to the rear panel ASSIGNABLE SWITCH jack.

The function that will be controlled by the foot switch and the polarity of the foot switch can be set in GLOBAL 1.1-3: System, Foot page "Foot SW Assign," and "Foot SW Polarity" (PG p.113, PG p.125, 222).

Damper pedal connections

Allows you to sustain the sound while playing.

Connect a Korg DS-1H damper pedal (separately sold option) to the rear panel DAMPER jack. If a DS-1H is connected, you can produce half-damper effects.

The polarity of the damper pedal can be set in GLOBAL 1.1-3: System, Foot page "Damper Polarity," and its sensitivity can be adjusted by the GLOBAL 1.1-1 System utility menu command "Half Damper Calibration." (PG p.124, 126)

Connections to MIDI equipment/ computers (MIDI connectors)

1. Connections to MIDI equipment

The keyboard, controllers, and sequencer etc. of TRITON Le can be used to control an external MIDI tone generator. Conversely, another MIDI keyboard or sequencer can control the tone generator of TRITON Le to produce sound.

- Use MIDI cables to connect the MIDI connectors of TRITON Le with the MIDI connectors of your external device.

PG p.231 "MIDI applications – Connecting MIDI devices/computers"

2. Connections to a computer

Your performance on the TRITON Le, as well as controller and sequencer data, can be sent to a computer (connected via MIDI interface), and the tone generator of TRITON Le can be played from the computer.

- Use a MIDI interface to connect the MIDI connectors of TRITON Le to the MIDI connectors of your computer.

PG p.231 "MIDI applications – Connecting MIDI devices/computers"

Connecting separately sold options

By installing the separately sold EXB-SMPL option you can add two channels of audio input jacks and a SCSI connector.

For details on installing the EXB-SMPL, refer to PG p.253.

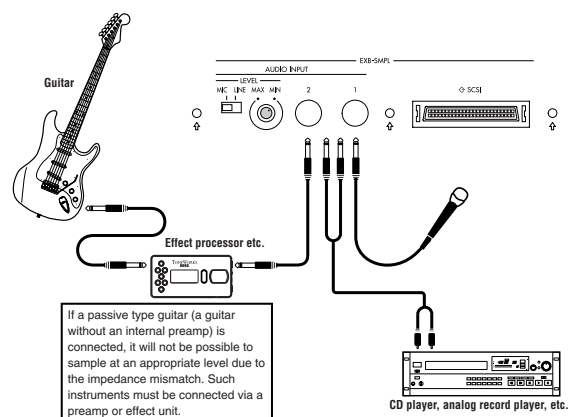

1. Audio input connections

Connect a mic or the OUTPUT jacks of an external audio device to the AUDIO INPUT 1, 2 jacks when you want to sample in Sampling mode (if the separately sold EXB-SMPL option is installed), or in Program, Combination, or Sequencer mode when you want to apply an internal effect to an external input sound and output the processed sound from the OUTPUT jacks.

- For details on connections when sampling in Sampling mode, refer to p.34.
- For details on connections when applying an effect in other modes and outputting to the OUTPUT jacks, refer to p.111.

2. SCSI connections

You can connect SCSI-compatible devices (hard disks, CD-ROM drives etc.). (EXB-SMPL Operation Manual)

Basic operation

Selecting modes, pages and tabs; setting parameters

1. Selecting modes

- In order to use a particular function on the TRITON Le, you must first select the appropriate mode. Press one of the front panel mode keys to enter the corresponding mode.

[COMBI] key:	Combination mode
[PROG] key:	Program mode
[SEQ] key:	Sequencer mode
[GLOBAL] key:	Global mode
[MEDIA] key:	Media mode
[SAMPLING] key:	Sampling mode (if the separately sold EXB-SMPL option is installed)

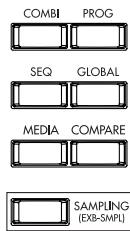

2. Selecting pages and tabs

Each mode has a large number of parameters, which are grouped into pages. Each page is further divided into as many as seven groups. These are referred to as "tabs."

Selecting a page

- ① Make sure that the desired mode is selected.

To select a mode, press the appropriate mode key. Here we will use Combination mode as an example for our explanation. Press the [COMBI] key.



- ② Press the [MENU] key.

The page menu will appear.

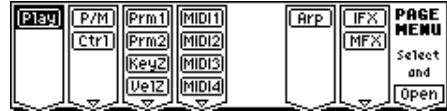

- note** In Media mode there is only one page, so the page menu will not appear.

- ③ Press the function key [F1]–[F7] that is nearest the page you wish to select.

If multiple pages are assigned to one function key, press the same key to move the cursor downward. You can also use the [▲], [◀], [▼], [▶] cursor keys to move.

- ④ Press the [F8] ("Open") key.

When you press the [F8] key, you will jump to the selected page, and that page will appear. As an example here, press the [F3] key three times to select "KeyZ," and then press the [F8] ("Open") key. The 3.3: Ed-Key Zone page will appear.

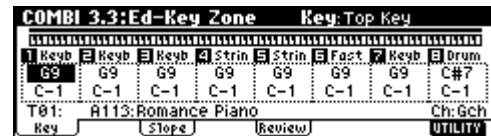

- note** You can also use the following alternative methods to select a page.

- Press the [MENU] key, and then use the [◀], [▶] keys to move forward or backward through the pages in the order of 1.1→2.1→2.2→3.1 etc.
- Hold down the [MENU] key, and use numeric keys [1]–[7] to enter a two-digit page number to move directly to the corresponding page. (To select the page shown above, you would press [3], [3].) If only one page is assigned to each function key (group), as in COMBI 1.1: Play or the pages of Global mode, the first digit of the numeric key [1]–[7] will move to the corresponding page.

The page selected at this time will be the page that was last selected. If there is no corresponding page, nothing will happen.

- note** When you press the [EXIT] key, you will return to 1.1 from any page.

Selecting a tab

- ⑤ Press the function key [F1]–[F7] that is nearest the tab displayed at the bottom of the LCD screen.

As an example, we will select the “Slope” tab. Press the [F3] key.

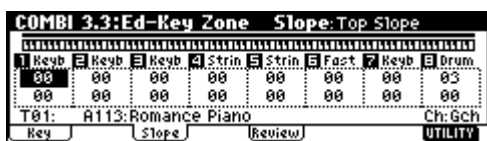

note Some pages have no tabs.

- ⑥ To move to another page, press the [MENU] key and repeat the procedure from step ③.

3. Selecting parameters

Use the [▲], [◀], [▼], [▶] cursor keys to select the parameter that you wish to edit.

In Combination mode pages that display timbres 1–8, or in Sequencer mode pages that display tracks 1–8 or 9–16, you can hold down the [TIMBRE/TRACK] key and press the nearest function key [F1]–[F8] to select the desired timbre or track.

4. Setting a parameter

The parameter value in the edit cell can be set by using the front panel VALUE controllers ([INC]/[DEC] keys, [VALUE] dial, numeric keys [0]–[9], [-] key, [./HOLD] key, and [ENTER] key). As necessary, you can also use the BANK [A]–[GM] keys, and the [COMPARE] key. In the case of parameters that require you to enter a note or velocity value, you can enter the value by playing a key on the keyboard while holding down the [ENTER] key.

VALUE controllers

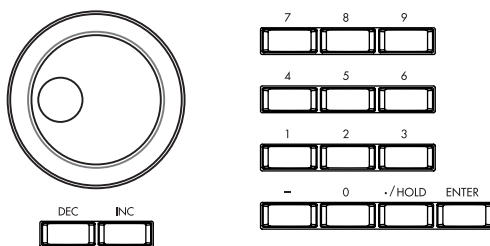

[INC]/[DEC] keys

Use these when you wish to make fine adjustments to the value.

[VALUE] dial

Use this when you wish to make large changes in a value.

Numeric keys [0]–[9], [ENTER] key, [-] key, [./HOLD] key

Use these when you know the parameter value that you wish to input.

After using the numeric keys [0]–[9] to input a number, press the [ENTER] key to finalize the parameter value. Use the [-] key to enter negative numbers.

Use the [./HOLD] key to enter a decimal point. In the 1.1: Play page of Program and Combination modes, the [./HOLD] key will perform the Category Hold or 10's Hold function. (PG p.2)

BANK [A]–[GM] keys

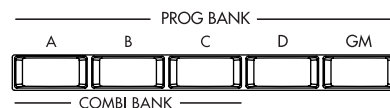

The BANK [A]–[GM] keys are used in Program mode to select the program bank and in Combination mode to select the combination bank. In Combination mode, they are also used to select the program bank for each timbre of the combination. In Sequencer mode, these keys are used to select the bank of the program used by each track of the song.

These keys are also used to specify the bank in dialog boxes such as Write Program or Write Combination.

[COMPARE] key



Use this key when you wish to compare an edited program or combination sound with the un-edited original (i.e., the sound that is written into memory).

When editing a program or combination, press this key. The key will light, and the last-written settings for that program number or combination number will be recalled. When you press the [COMPARE] key once again, the key will go dark and you will return to the settings that you were editing.

If you edit the settings that are recalled by pressing the [COMPARE] key (i.e., the settings that are written into memory), the key will go dark, and it will not be possible to return to the previous settings by pressing the [COMPARE] key again.

In Sequencer mode, you can use the [COMPARE] key to make “before and after” comparisons immediately after using realtime recording or step recording to record a song, or after performing a track edit operation.

For example, this can be used effectively when realtime-recording a track for a song.

- ① Realtime-record a track. (Take 1)
- ② Once again, realtime-record on the same track. (Take 2)
- ③ Press the [COMPARE] key. The key will light, and take 1 will be recalled.
- ④ Press the [COMPARE] key once again. The key will go dark, and take 2 will be recalled.

-
- ⑤ If after recording two different takes on the same track, you record a third, the Compare function will now alternate between the second and third takes. Recording a fourth take will mean that Compare now alternates between takes three and four, and so on. In this fashion, Compare always alternates between the last two recorded passes that are made on the same track.

In this way, the Compare function lets you recall the previous recording or the previous state of event editing.

- ⚠ The Compare function is not available in Global, Media and Sampling modes.

Keyboard input

When inputting a note name or velocity value as the value of a parameter, you can use the keyboard to input the setting. Hold down the [ENTER] key and play the note that you wish to enter as a value. The note name (number) or velocity value will be input. When the GLOBAL 5.1: DKit page or SEQ 5.1: RPPR, RPPR Setup page is displayed, you can hold down the [ENTER] key and play a note to recall the settings that have been assigned to the note you played.

Quick Start

Turning the power on/off

- ⚠ Before you turn on the power, make sure that the desired connections have been made as described in “Connections” (p.12).

1. Turning the power on

- ① Press the TRITON Le’s [POWER] switch to turn on the power.

The LCD screen will display the name of your model, and the software version.
(The following graphic shows the factory-set LCD screen . The version number is subject to change without notice.)



- ② Turn on your powered monitors or stereo amp.
- ③ Raise this instrument’s [VOLUME] slider to an appropriate level, and adjust the volume of your powered monitors or stereo amp.

2. Turning the power off

- ① Set this instrument’s [VOLUME] slider and the volume of your powered monitor or stereo amp to zero.
- ② Turn off the power of your powered monitor or stereo amp.
- ③ Press this instrument’s [POWER] switch to turn off the power.

- ⚠ Never turn off the power while data is being written into internal memory.
If the power is turned off while processing is being performed, memory write operations will not be completed correctly. If this occurs, this instrument will automatically initialize its internal memory so that it will operate correctly. This is not a malfunction.

While data is being written, the LCD screen will indicate “Now writing into internal memory.”
Data is written into internal memory by the following operations.

- Writing (updating) a Program, Combination, Global Setting, Drum Kit, or Arpeggio Patterns
- Loading Program, Combination, Global Setting, Drum Kit, or Arpeggio Patterns data in Media mode
- Receiving a MIDI data dump for Program, Combination, Global Setting, Drum Kit data, or Arpeggio Patterns

- When using Sampling mode (if the separately sold EXB-SMPL option is installed) utility commands (“Move Sample,” “Move MS,” “Conv.To Prog,” “Time Slice,” etc.) to simultaneously modify programs or drum kits.

The mode and page that will be selected when the power is turned on

The state of this instrument when the power is turned on will depend on the setting of “Power On Mode” (GLOBAL 1.1: System, Preference page).

If “Power On Mode” is **Reset** (factory setting), this instrument will automatically select the Combination mode 1.1: Play.

If “Power On Mode” is **Memorize**, this instrument will be in the mode and page that were last selected when the power was turned off.

The **Memorize** setting will remember the mode and page that were last selected, the combination number that was last selected in Combination mode, and the program number that was last selected in Program mode. If another mode is selected when the power is turned on, you can press the [COMBI] key or [PROG] key to select the 1.1: Play page with the last-selected combination number or program number.

LCD screen messages when separately sold options are installed (When the power is turned on)

This instrument allows you to install separately sold options.

When the power is turned on, the type of installed options will be displayed. After installing an option, be sure to check this display to verify that the option was installed correctly. If the option is not displayed here even though it was installed, it was not installed correctly. Turn off the power and re-install the option.
(For details on installing an option, refer to PG p.253)



OPTIONS

EXB-SMPL:

The EXB-SMPL option is installed.

SIMM:

Slot1 (**MB)/Slot2 (**MB): SIMM’s are installed in SIMM slots 1 and/or 2. The capacity of each SIMM is shown in parentheses.

Listening to a demo song

Loading demo playback data

The TRITON Le contains demo songs (and preloaded data). This data can be loaded in Global mode.

- ① Press the [GLOBAL] key (the key will light).
You will enter Global mode.
Verify that the GLOBAL 1.1: System page is displayed. If it is not displayed, press the [EXIT] key.
- ② Press the [F8] ("UTILITY") key to access the Utility menu.
- ③ Press the [F7] (") key to select "Load Preload/Demo Data," and press the [F8] ("OK") key.



A dialog box will appear.

- ④ Use the [INC]/[DEC] keys to select the data that you want to load.

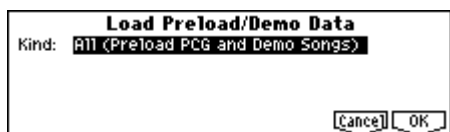

In the "Kind" field, select the data that you want to load.

In this case, select **All (Preload PCG and Demo Songs)**. When you execute the Load operation, the demo song data and preloaded data will be loaded.

- ⑤ Press the [F8] ("OK") key.
A dialog box will ask you for confirmation.



- ⑥ Press the [F8] ("OK") key once again.
The preloaded data and demo song data will be loaded.

- ⚡ Never turn off the power while the data is being loaded.
- ⚡ If the Memory Protected dialog box appears, uncheck the memory protect setting, and perform the Load operation again. (p.42)

note From the powered-off state, if you turn on the power while holding down the [MENU] key and [EXIT] key, the **Load All (Preload PCG and Demo Songs)** operation will be executed automatically. (The LCD screen will show a message of "Now Writing Internal Memory.") This will load all PCG data and demo song data. Never turn off the power while the data is being loaded.

Selecting and playing a demo song in the Sequencer mode

- ① Press the [SEQ] key (the key will light).
You will enter Sequencer mode.
- ② Access the SEQ 1.1: Play/REC, Play/REC page.





If the SEQ 1.1: Play/REC, Play/REC page does not appear, select it as follows.

- 1) Press the [MENU] key.
The LCD screen will show a list of the pages in Sequencer mode.



- 2) Press the [F1] key to select "P/R," and press the [F8] ("OPEN") key.
- 3) Press the [F1] key. The SEQ 1.1: Play/REC, Play/REC page will be displayed.

- ③ Use the cursor keys [, ] to choose "Song Select."

The song name will be highlighted.

- ④ Use the [INC]/[DEC] keys or other VALUE controllers to select the demo song that you wish to play.
- ⑤ Press the [START/STOP] key.
The key will blink and the selected song will play.
- ⑥ If you wish to stop playback, press the [START/STOP] key once again.

Playing a cue list

Here's how to playback the demonstration cue list. By using a cue list, you can repeatedly play multiple songs that you specify in the cue list, or play songs consecutively. (p.71)

- ① Press the [MENU] key.
- ② Press the [F2] key to select "Cue," and then press the [F8] ("OPEN") key.

The SEQ 2.1: Cue List, Setup&Play page will appear.



- ③ Press the [START/STOP] key.
- ④ To stop playback, press the [START/STOP] key once again.

If the last step is **End**, playback will stop automatically when it reaches that point. If the last step is **Continue to Step01**, playback will return to the first step and continue.

To select a cue list, choose "Cue List Select," and use the same procedure as when selecting a song. Refer to step ④ above.

Contents of the preloaded data and demo songs

Preload PCG

- Preloaded data (programs, combinations, drum kits, arpeggio patterns, global settings)

note When you load the preloaded data, it will be written into internal memory. This data is preserved even when the power is turned off.

! When this data is loaded, the PCG data that had been previously written will be replaced. If you do not want to lose this data, save it on SmartMedia beforehand. (p.45)

Demo Songs

- Demonstration song and demonstration cue list data

note This data is loaded into the internal sequencer memory. The data will be lost when the power is turned off.

! When you load All Demo Songs, the data that had been written before loading this data will be rewritten. If you wish to keep this data, you must first save it on a SmartMedia before loading All Demo Songs. (p.45)

Selecting and playing a program

In Program mode you can select and play a program from banks A–D, G, g(d). Here we will show how to select preset programs. Select various programs and hear how they sound.

Selecting a program

- Press the [PROG] key (the key will light).

You will enter Program mode. Make sure that the upper line of the LCD screen indicates “PROG 1.1: Play.”



Selecting a program number

- Make sure that “Program Select” is selected.

If it is not selected, use the cursor keys [▲], [◀], [▼], [▶] to highlight the program name in “Program Select.”

- Use the VALUE controllers to select the program that you wish to play.

You can use the following methods to select a program.

- Rotate the [VALUE] dial.
- Press the [INC] or [DEC] key.
- Use numeric keys [0]–[9] to specify the number, and press the [ENTER] key.

- Audition the sound.

Play a note on the keyboard to hear the sound you selected.

Alternatively, you can press the [AUDITION] key (the key will light) to turn on the Audition function and the TRITON Le will automatically play a riff (phrase) suitable for the selected program.



- With the factory settings, the Audition function can be used only on the preloaded programs of banks A–C, D000–063, and the preset programs G, g(d).

Selecting the program bank

In Program mode, you can switch banks to select programs from another bank.

With the factory settings, banks A, B, C, D000–063 and G, g(d) contain programs. (☞ table below)

- Press a BANK [A]–[GM] key to select a bank.

The key will light, and the selected bank will be displayed in the left of the LCD screen. For example to select bank B, press the BANK [B] key. (The [B] key will light, and the upper left of the LCD screen will indicate Bank B.)

Bank	Prog. No.	Explanation
A, B, C	000...127	for preloaded programs
D	000...063	
D	064...127	for user programs
G	001...128	GM programs
g(d)	(☞ VNL)	GM2 drum programs

A, B, C, D000–063

With the factory settings, these banks contain a wide variety of preloaded programs that use the internal PCM ROM multisamples, effects, and arpeggio patterns.

D064–127

With the factory settings, these banks do not contain programs. Programs you yourself create can be stored in these banks.

128 programs can be written or rewritten to each bank A–D (for a total of 512).

G, g(d) These banks contain 128 GM programs and 9 GM drum programs that are compatible with the GM sound map. The programs of these banks are read-only. Bank G contains the GM programs. G lets you select 128 programs numbered from 001–128, and g(d) lets you select nine drum programs (☞ VNL).

Each time you press the [GM] key, the bank will alternate as shown below.

G→g(d)→G→g(d)→G...

- ☞ For details of the program names etc., refer to “VNL” (Voice Name List).

Selecting programs by category

You can select programs by categories such as keyboard, organ, bass, and drums. With the factory settings, all the preloaded programs are organized into sixteen categories. You can choose a category, and then select from the programs in that category.

On this instrument, you can use one of the following two methods to select programs by category.

Select by Category

- 1 Make sure that **PROG 1.1: Play** is displayed.
- 2 Press the [CATEGORY] key.



The Select by Category dialog box will appear. The categories are displayed in the left side of the screen, and a list of the programs in the selected category are displayed in the right side.

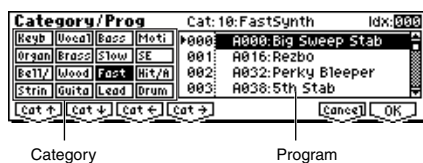

- 3 Use the [F1] (“**Cat +**”), [F2] (“**Cat -**”), [F3] (“**Cat <**”), and [F4] (“**Cat >**”) keys to select the desired category.
- 4 Use the [▲], [▼] cursor keys to select the desired program.
- 5 To execute, press the [F8] (“OK”) key. To cancel without executing, press the [F7] (“Cancel”) key.

Cat. HOLD (Category Hold)

- 1 Press the [./HOLD] key to display **cat. HOLD**.

The category will be held.



- 2 Use the cursor keys [▲], [◀], [▼], [▶] to choose “Category,” and use the VALUE controllers to specify the category.
- 3 Use the cursor keys [▲], [◀], [▼], [▶] to choose “Program Select,” and use the VALUE controllers to successively select programs in that category.
- 4 To exit the Category Hold function, press the [./HOLD] key twice to erase the **cat. HOLD** display.

note In PROG 1.1: Play, pressing the [./HOLD] key will cycle through **cat. HOLD** → **10's HOLD** → cancel.

Using 10's HOLD to select programs

You can fix the ten's place of the program number as you select programs.

- 1 Press the [./HOLD] key to make the display indicate **10's HOLD**.

The ten's place of the program number will be held (fixed).



- 2 By pressing a numeric key [0]–[9], you can input the one's place in a single action.
- 3 You can use the [INC]/[DEC] keys to change the ten's place.
- 4 To cancel the 10's HOLD function, press [./HOLD] to erase the **10's HOLD** display.

Using a connected switch to select programs

A separately sold on/off-type switch (such as the separately sold Korg PS-1) can be connected to the rear panel ASSIGNABLE SWITCH connector, and assigned a program select function. (esp.113)

Selecting programs from a MIDI device

MIDI program change messages can be transmitted from an external MIDI device, and received by this instrument to select programs. (esp. PG p.232)

Selecting and playing a combination

In Combination mode you can select and play a combination from **banks A–C**. Select various combinations and hear how they sound.

Selecting a combination

- 1 Press the [COMBI] key (the key will light).

You will enter Combination mode. Make sure that the upper line of the LCD screen indicates “COMBI 1.1: Play.”



Selecting a combination number

- 2 Make sure that “Combi Select” is selected.

If it is not selected, use the cursor keys [▲], [◀], [▼], [▶] to highlight the combination name in “Combi Select.”

- 3 Use the VALUE controllers to select the combination that you wish to play.

☞p.20 “Selecting a program” ③

- 4 Audition the sound.

Play a note on the keyboard to hear the sound you selected.

Selecting the combination bank

In Combination mode, you can switch banks to select combinations from another bank.

With the factory settings, banks A, B, and C contain combinations. (☞ table bellow)

- 5 Press a BANK [A]–[C] key to select a bank.

The key will light, and the selected bank will be displayed in the left of the LCD screen. For example to select bank B, press the BANK [B] key. (The [B] key will light, and the upper left of the LCD screen will indicate **Bank B**.)

Bank	Prog. No.	Explanation
A, B, C	000...127	for preloaded combinations (for user combinations)

A, B, C With the factory settings, these banks contain a wide variety of preloaded combinations that use multiple programs, effects, and arpeggio patterns.

128 programs can be written or rewritten to each bank A–C (for a total of 384).

☞ For details of the combination names etc., refer to “VNL” (Voice Name List).

Selecting combinations by category

You can select combinations from sixteen categories in the same way as for programs.

With the factory settings, all the preloaded combinations are organized into sixteen categories. You can choose a category, and then select from the combinations in that category.

☞p.21 “Selecting programs by category”

Using 10’s HOLD to select combinations

You can fix the ten’s place of the combination number, so that a combination can be selected simply by pressing a numeric key once to change the one’s place.

☞p.21 “Using 10’s HOLD to select programs”

Using a connected switch to select combinations

A separately sold on/off type foot switch such as the Korg PS-1 can be connected to the rear panel ASSIGNABLE SWITCH jack, and used to select combinations. (☞p.113)

Selecting combinations from a MIDI device

MIDI program change messages can be transmitted from an external MIDI device, and received by this instrument to select combinations. (☞PG p.232)

Using controllers to modify the sound

The TRITON Le provides various controllers – a joystick, the SW1 and SW2 switches, and the REALTIME CONTROL [1], [2], [3], [4] knobs – that let you modify the tone, pitch, volume, or effects in realtime while you play.

Each time you select a program or combination, try out these controllers to hear how they affect the sound.

note Tonal changes etc. created using these controllers can be recorded on the internal sequencer or on an external MIDI sequencer.

Joystick

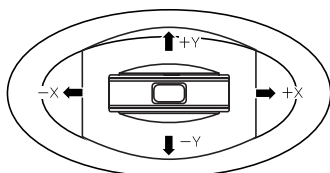

JS(+X): Move the joystick toward the right to apply an effect. Normally this is used to control the pitch (bend up).

JS(-X): Move the joystick toward the left to apply an effect. Normally this is used to control the pitch (bend down).

JS(+Y): Move the joystick away from yourself to apply an effect. Normally this is used to control the oscillator LFO (vibrato).

JS(-Y): Move the joystick toward yourself to apply an effect. Normally this is used to control filter LFO (wah).

note You can use the Lock function of [SW 1] or [SW 2] keys to hold the effect in the current joystick position, before the joystick is released to the center position. For the procedure, refer to “The lock function.”

note You can use the joystick as a source for alternate modulation or effect dynamic modulation, to control program parameters or effect parameters.

SW1, SW2

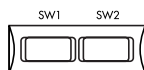

You can use these keys as sources for alternate modulation or effect dynamic modulation to control program parameters or effect parameters.

These switches can also be used to switch the octave, to turn portamento on/off, or to lock the position of the after touch **lock function** (p.24).

You can specify the way in which the [SW1] and [SW2] keys will operate: either **Toggle**, when the assigned function will be switched on/off each time the key is pressed, or **Momentary**, when the assigned function will be switched on only as long as you hold down the key.

note The function of the [SW1] and [SW2] keys can be verified for Program mode in the 1.1: Play, Program page, or for Combination mode in the 1.1: Play, Combination page. (p.25)

note When you write a program or combination, the on/off status of the [SW1] and [SW2] keys is saved.

note For details on making these settings, refer to “Setting the function of [SW1] and [SW2]” (p.115).

The Lock function

- 1 Select program bank A001: Acoustic Piano, and play the keyboard.

To select a program, make sure that you are in Program mode, and press the Bank [A] key, numeric key [1], and then the [ENTER] key.

- 2 Move the joystick toward yourself (the -Y direction).

The modulation will deepen, and at the same time, resonance will be applied to give a unique character to the sound.

- 3 While holding the joystick toward yourself, press the [SW2] screen (The [SW2] key will light).

The tone at this point will be maintained. (**Lock function**)

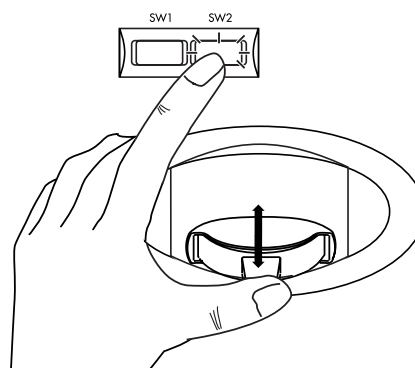

- 4 Release the joystick, and play the keyboard.

The tone will stay the same as it was when the [SW2] key was pressed. Moving the joystick toward yourself will not affect the sound.

note In the lower part of the LCD screen, SW2 will indicate **JS-Y Lock**. This means that the function of the [SW2] key is set to **JS-Y Lock**. (It will operate as a **Toggle** switch.)

If the function of the [SW1] or [SW2] key is set to

JS X Lock, JS+Y Lock, or JS-Y Lock, the tone that was heard when the joystick is tilted can be maintained even after the joystick is returned to the center position.

Similarly, there is an **AfterT Lock** function that locks the aftertouch effect. (PG p.220)

- ⑤ Press the [SW2] key once again to defeat the lock.

note In many programs and combinations, the joystick - Y axis lock function is assigned to the [SW2] key.

REALTIME CONTROLS [1], [2], [3], [4]

These knobs can be used to control the filter cutoff frequency and resonance, the amp and filter EG, volume, portamento time, pan, pitch LFO, or the send levels to the master effects, etc.

- ① Press the REALTIME CONTROLS [SELECT] key to switch the function of the realtime controllers to A-mode, B-mode, or C-mode.

Each time you press the key, A-mode, B-mode or C-mode will be selected alternately, and the corresponding LED will light.

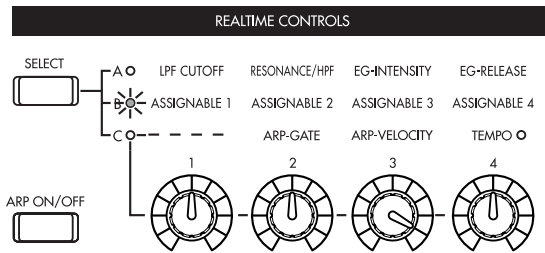

- ② Rotate the desired knob to control the sound, etc.

A-mode controls

In A-mode, knobs [1]–[4] will control/edit the following functions.

note Placing the knobs in the center (12 o'clock) position will produce the values specified by the program parameters.

Knob [1]: LPF CUTOFF

Adjust the cutoff frequency of the low pass filter. When you adjust the cutoff frequency of the filter, the brightness of the sound will change. The effect will depend on the settings of the program parameters, but normally, rotating the knob toward the left will darken the sound, and rotating it toward the right will brighten it.

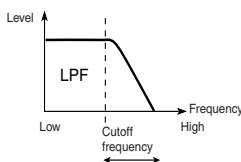

Knob [2]: RESONANCE/HPF

Adjust the resonance level of a low pass filter or the cutoff frequency of a high pass filter. The content that is controlled will depend on the filter type specified by the program.

By adjusting the filter resonance level, you can increase or decrease the resonance level to add a unique character to the sound.

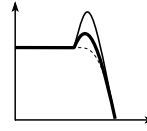

Adjusting the cutoff frequency of the high-pass filter will modify the thickness of the sound from which the low frequency range has been filtered out.

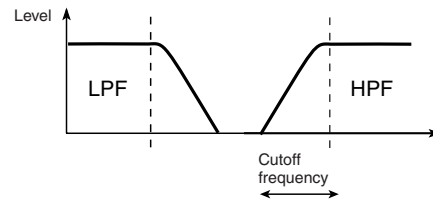

Knob [3]: EG-INTENSITY

Adjust the filter EG intensity (the depth at which the filter EG is applied).

Rotating the knob will affect the depth of the filter EG. Normally, rotating the knob toward the left will make the filter EG apply less deeply, and rotating it toward the right will make the filter EG apply more deeply. Since the filter EG will operate based on the cutoff frequency of the filter, knobs [1] and [3] will work together to control the tonal changes produced by the filter.

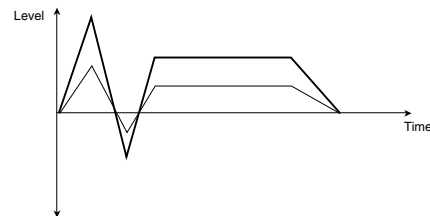

Knob [4]: EG-RELEASE

Adjust the EG release times of the filter and amp. This will determine the time from note-off until the sound disappears.

When you adjust the knob, the release times of the filter EG and the amp EG will change. Normally, rotating the knob toward the left will shorten the release time, and rotating it toward the right will lengthen the release time.

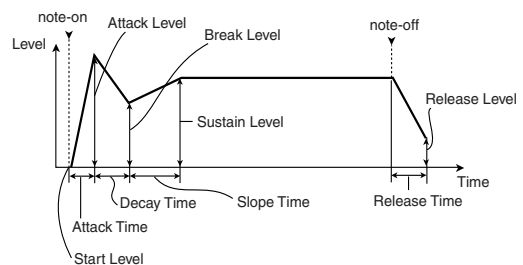

B-mode controls

You can control parameters such as volume, portamento time, pan or filter and amp EG, pitch LFO, and master effect send levels etc.

The B-mode function settings are made for each individual program, combination, or song.

In Sampling mode, the B-mode functions are set for the entire mode (if the EXB-SMPL option is installed) (p.115).

C-mode control

You can control the effect of the arpeggiator in real-time. For details on operation, refer to p.26.

Viewing the parameters that are assigned to [SW1], [SW2] keys, and the REALTIME CONTROLS B mode

In Program and Combination modes, the B-mode functions of the REALTIME CONTROLS knobs [1], [2], [3], and [4] and [SW1]/[SW2] keys can be verified in the 1.1: Play page.



Functions assigned to the [SW1] and [SW2] keys

Functions assigned to Knob1-4

Keyboard

Velocity

The force with which you initially strike a note can apply an effect.

Normally this is used to control volume, or the speed or sensitivity of the EG.

After Touch

This effect can be applied by varying pressure on a key that is already being held down.

Normally this is used to control volume, tone (cutoff frequency), or LFO sensitivity etc.

Note Number

Varying amounts of an effect will be applied depending on the position of the key on the keyboard.

Normally this is used to control volume, tone (cutoff frequency), LFO sensitivity, and EG sensitivity etc.

note This can be used as a source for alternate modulation or effect dynamic modulation, to control program parameters or effect parameters.

Foot pedals

Damper Pedal

A separately sold Korg switch-type damper pedal such as the DS-1H can be connected to this instrument. If a DS-1H is connected, it will function as a half-damper pedal. The half-damper function cannot be controlled by other pedals.

Assignable Foot Switch

A separately sold on/off switch such as the Korg PS-1 foot switch can be connected to this instrument, allowing you to turn an assigned function on/off by stepping on the foot switch.

The function of the foot switch is assigned in GLOBAL 1.1: System "Foot SW Assign" (p.113).

Assignable Foot Pedal

A separately sold Korg expression pedal such as the EXP-2 foot controller or XVP-10 EXP/VOL pedal can be connected to the rear panel ASSIGNABLE PEDAL jack, and used to apply an effect.

The function of the foot pedal is assigned in GLOBAL 1.1: System Foot page "Foot Pedal Assign" (p.113).

Using the arpeggiator while you play

The **arpeggiator** is a function that automatically generates arpeggios (broken chords). Most arpeggiators produce an arpeggio when you play a chord on the keyboard.



The chord you played on the keyboard is sounded as an arpeggio (broken chord)

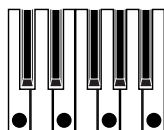

In addition to this, the TRITON Le's arpeggiator is a polyphonic arpeggiator that is able to produce a variety of chordal transformations or phrases based on the pitch or timing of the notes you play on the keyboard. These functions let you use the arpeggiator to play a wide range of patterns including drum or bass phrases, and guitar or keyboard backing riffs. It is also effective to use the arpeggiator as part of the sound-creating process when creating subtly-moving pads, synth-sounds, or sound effects.

In addition, the TRITON Le features a Dual Arpeggiator that lets you simultaneously use two arpeggio patterns in Combination mode and Sequencer mode. You can take advantage of this in many ways, such as applying separate arpeggio patterns to a drums program and a bass program, or using keyboard split or velocity to switch between two arpeggio patterns.

The TRITON Le provides five preset arpeggio patterns (the standard **UP**, **DOWN**, **ALT1**, **ALT2**, and **RANDOM**), and lets you program and store 216 user arpeggio patterns. With the factory settings, these contain a wide variety of preload user arpeggio patterns (VNL). An arpeggio pattern that you create can also be stored as a user arpeggio pattern (p.103).

Using the arpeggiator in Program mode

- 1 Press the [PROG] key to enter Program mode, and select a program. (p.20 "Selecting and playing a program")

As you select various programs, you will notice that the [ARP ON/OFF] key LED will light for some programs. (p.29 "Other settings for the arpeggiator") Play the keyboard of the TRITON Le and the arpeggio will start.

For other programs, you can press the [ARP ON/OFF] key (the key will light) to turn on the arpeggiator. Arpeggios will begin sounding when you play the keyboard.

- 2 As described in the following sections "Settings using controllers" and "Settings in the LCD screen," move the controllers or modify the parameters to change the way in which the arpeggios are played.

Settings using controllers

Arpeggiator on/off

- Each time you press the [ARP ON/OFF] key, the arpeggiator will be switched on/off.

When this is on, the key will light, and playing the keyboard will start the selected arpeggio pattern.

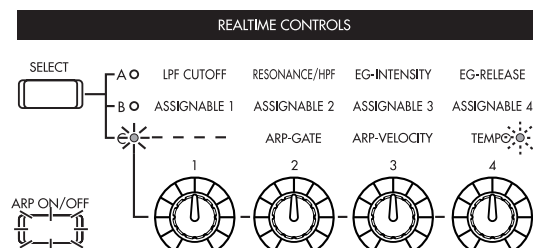

note The on/off status is saved when you write the program, Combination.

! In Combination and Song, depending on the arpeggiator A, B settings, the arpeggio may not start when you press the [ARP ON/OFF] key to turn it on (p.28).

Adjusting the arpeggiator tempo

- ① Press the REALTIME CONTROLS [SELECT] key to make the right “C” LED light.
- ② Rotate the [TEMPO] knob to adjust the tempo.

The “♩=” value in the upper right of the LCD screen will change. You can set this in the range of 40–240. The [SELECT] key LED will blink at quarter-note (♩) intervals.

You can also Use the cursor keys [▲], [◀], [▼], [▶] to select “♩=,” input the tempo using numeric keys [0]–[9], and press the [ENTER] key to set the tempo. Alternatively, you can set the tempo using the [VALUE] dial or the [INC]/[DEC] keys. The tempo will blink at the specified tempo.

note The Tempo knob setting is saved when you write the program.

note The arpeggio playback speed is affected by the “Reso (Resolution)” setting (1.1: Play, Arp. Play page, 6.1: Ed-Arp., Arpeg. Setup page).

note If “MIDI Clock” (GLOBAL 2.1: MIDI) is set to **External**, the display will indicate “♩= EXT.” The tempo will be synchronized to an external MIDI device, and it will not be possible to adjust the tempo on the TRITON Le.

Adjusting the length of the arpeggio notes

- ① Press the REALTIME CONTROLS [SELECT] key to make the right “C” LED light.
- ② Rotate the [ARP-GATE] knob to adjust the duration of the arpeggiated notes.

Rotating the knob toward the left will shorten the notes, and rotating it toward the right will lengthen the notes. At the center position (12 o’clock), the note length will be as specified by the program parameter “Gate” (6.1: Ed-Arp., Arpeg. Setup page).

note The knob setting is saved when you write the program.

note You can control the effect by simultaneously adjusting the REALTIME CONTROLS A-mode [4] (EG-RELEASE) knob.

Adjusting the strength of the arpeggio notes

- ① Press the REALTIME CONTROLS [SELECT] key to make the right “C” LED light.
- ② Rotate the [ARP-VELOCITY] knob to adjust the strength of the arpeggiated notes.

Rotating the knob toward the left will make the notes weaker, and rotating the knob toward the right will make the notes stronger. At the center position (12 o’clock), the velocity will be as specified by the program parameter “Velocity” (6.1: Ed-Arp., Arpeg. Setup page).

note The knob setting is saved when you write the program.

note You can control the tone effectively by simultaneously adjusting the REALTIME CONTROLS A-mode [1] (LPF CUTOFF), [2] (RESONANCE/

HPF), and [3] (EG-INTENSITY) knobs.

Settings in the LCD screen

- In PROG 1.1: Play, press the [F3] key to select the Arp. Play page.



Selecting an arpeggio pattern

An arpeggio pattern can be selected from preset arpeggio patterns P000–P004 and user arpeggio patterns U000 (INT)–215 (User). With the factory settings, U000–199 (INT) contain a wide variety of preset user arpeggio patterns (≡VNL)

- Use the cursor keys [▲], [◀], [▼], [▶] to select “Pattern,” and use the [VALUE] dial or the [INC]/[DEC] keys to select the arpeggio pattern. To select a user arpeggio pattern, use numeric keys [0]–[9] to input the pattern number, and press the [ENTER] key.

Changing the timing value of the arpeggio notes

The “Reso (Resolution)” parameter in the LCD screen lets you set the timing value of the arpeggiated notes in a range of ♩₃–♩.

- Use the cursor keys [▲], [◀], [▼], [▶] to select “Reso,” and use the [VALUE] dial or the [INC]/[DEC] keys to specify the spacing of the arpeggiated notes.

Selecting the octave range in which the arpeggio is sounded

Use the “Octave” in the LCD screen to specify the range of octaves in which the arpeggio will be sounded (≡p.100).

- Use the cursor keys [▲], [◀], [▼], [▶] to select “Octave,” and use the [VALUE] dial or [INC]/[DEC] keys to specify the range of octaves in which the arpeggio will be sounded.

Sounding an arpeggio in the order of the pitches in the chord you played

You can select whether the notes of the arpeggio will be sounded in the order of the pitches in the chord you played (regardless of the order in which you actually played the notes), or in the order in which you played the notes.

- Use the cursor keys [▲], [◀], [▼], [▶] to select the “Sort” check box, and use the [VALUE] dial or the [INC]/[DEC] keys to make the setting.

Checked: the arpeggio will sound each note in the order of its pitch, regardless of the order in which you actually played the notes.

Unchecked: the arpeggio will sound each note in the order in which you actually played the notes.

Letting the arpeggio continue playing even after you take your hand off the keyboard

You can select whether the arpeggio will continue playing when you take your hand off the keyboard, or whether the arpeggio will stop playing when you take your hand off the keyboard.

- Use the cursor keys [▲], [◀], [▼], [▶] to select “Latch,” and use the [VALUE] dial or the [INC]/[DEC] keys to make the setting.

Checked: The arpeggio will continue playing even after you remove your hand from the keyboard.

Unchecked: The arpeggio will stop playing when you remove your hand from the keyboard.

Synchronizing the arpeggiator to your keyboard timing

You can specify whether the arpeggio will begin at the moment you play the keyboard, or whether it will always play in synchronization to the MIDI clock tempo.

- Use the cursor keys [▲], [◀], [▼], [▶] to select “Key Sync.,” and use the [VALUE] dial or the [INC]/[DEC] keys to make the setting.

Checked: When you take your hand completely off of the keyboard and then play the first note-on, the arpeggio pattern will start from the beginning. This setting is suitable when you want the arpeggio to start from the beginning of the measure as you are playing in realtime.

Unchecked: The arpeggio will always be synchronized to the MIDI clock tempo.

Sounding both the arpeggio notes and the notes you play

- Use the cursor keys [▲], [◀], [▼], [▶] to select “Keyboard” check box, and use the [VALUE] dial or the [INC]/[DEC] keys to make the setting.

Checked: The notes you play on the keyboard and the notes played by the arpeggiator will both sound.

Unchecked: Only the arpeggio notes will sound.

Using the arpeggiator as you play in Combination mode

In Combination mode the TRITON Le provides dual arpeggiators, allowing you to run two arpeggio patterns simultaneously.

- ① Press the [COMBI] key to enter Combination mode, and select a combination. (see p.22 “Selecting and playing a combination”)

As you select various combinations, you will notice that the [ARP ON/OFF] key will light for some combinations. (see “Other settings for the arpeggiator”) When you play a key on the keyboard, the arpeggiator will start.

For other combinations, you can press the [ARP ON/OFF] key (the key will light) to turn on the arpeggiator.

- ② As described in the preceding section “Settings using controllers” and the following section “Settings in the LCD screen,” move the controllers or modify the parameters to change the way in which the arpeggios are played.

▲ The [ARP ON/OFF] key and the REALTIME CONTROLS C-mode [TEMPO], [ARP-GATE], and [ARP-VELOCITY] knobs are valid for both arpeggiators A and B. Their state will be memorized when the combination is written.

Settings in the LCD screen

- In COMBI 1.1: Play, press the [F4] key to select the Arp. Play A page, and make settings for arpeggiator A.

In COMBI 1.1: Play, press the [F5] key to select the Arp. Play B page, and make settings for arpeggiator B.



Select the arpeggiator(s) that will run

Use the “Arpeggiator Run” check boxes to specify the arpeggiator(s) that you want to run. The arpeggiator(s) that are checked here will operate when the [ARP ON/OFF] key is on.

However, the arpeggiator will play a timbre only if the table displayed beside the check boxes assigns arpeggiator A or B to a Timbre 1–8. These settings are made in COMBI 6.1: Ed-Arp., Setup page “Assign” (see p.101).

Arpeggiator-A, Arpeggiator-B

For each arpeggiator A and B, you can make settings for “Pattern,” “Reso (Resolution),” “Octave,” “Sort,” “Latch,” “Key Sync,” and “Keyboard.” (see p.27)

Checking the structure of a user arpeggio pattern

Let's see how combination C053: Echo Jamm is constructed.

- 1 Select combination C053: Echo Jamm, and look at the Arp. Play A page and Arp. play B page.



- As you can see from the "Timbre Assign" table in the upper right, arpeggiator A is assigned to **timbre 4 and 8**, and arpeggiator B is assigned to **timbre 2**. When you play the keyboard the **U126 (INT): Dr-BigBeats 2** arpeggio pattern will play the program **B084: Drum'n'Bass Kit** of timbre 4. The **U043 (INT): Gt-Stab Rhythm** arpeggio pattern will play the program **B108: Funkin' Guitar** of timbre 2.
- If you **uncheck "Arpeggiator Run A"** or **"Arpeggiator Run B,"** the unchecked arpeggiator will stop.
If you **check** it once again and play the keyboard, the arpeggiator will begin running.
- Look at the COMBI 6.1: Ed-Arp., Zone page, and you will see that the A keys "Btm" and "Top" are set so that arpeggiator A will operate only for B3 and lower keys, and that the B "Top Key" and "Bottom Key" are set so that arpeggiator B will operate only for C4 and higher keys.

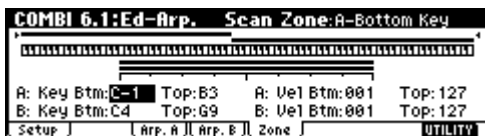

Other settings for the arpeggiator

You can also set "Gate," "Velocity," "Swing," and "Scan Zone." These parameters are set in PROG 6.1: Ed-Arp, COMBI 6.1: Ed-Arp. (p.100).

Linking the arpeggiator to program, combinations

You can specify whether the arpeggiator settings written in a program or combination will also be selected when you switch programs or combinations, or whether the arpeggiator status will not change when you switch programs or combinations.

With the factory settings, the former is selected. Use the latter when you want to keep the same arpeggio pattern running, and change only the program sound. This setting is made in "Auto Arp." (GLOBAL 1.1: System, Basic).

Creating an user arpeggio pattern

Arpeggio patterns that you create can be written to U000 (INT)–215 (User).

These can be created in GLOBAL 6.1: Arp.Pattern (p.104).

Playing with the RPPR (Realtime Pattern Play/Recording) function

This instrument's Sequencer mode provides an **RPPR (Realtime Pattern Play/Recording)** function.

Using the **RPPR function**, each note of the keyboard can be assigned to a preset pattern or user pattern and a track that will play the assigned pattern. You can then playback the assigned pattern in realtime (and record it, if desired) simply by playing a note. (Preset patterns suitable for playing by the drum track are already provided in internal memory.)

Here we will explain how to play a demo song using the RPPR function.

- ① **Load the demo song data as described in "Loading demo playback data" (p.18).**
- ② **Press the [SEQ] key (the key will light) to enter Sequencer mode, and access the SEQ 1.1: Play/REC, Play/REC page.**
- ③ **In "Song Select," select 000:Midnight Sun.**
Select the song as described in "Selecting and playing a demo song in Sequencer mode" (p.18).



- ④ **Make sure that the RPPR check box is checked.**
Checked: The specified RPPR (set in SEQ 5.1:PPPR, RPPR Setup) will function.
Unchecked: RPPR will not function. Operation will be as in normal Sequencer mode.
- ⑤ **Press a key.**
The pattern assigned to that key will playback. In some cases, the pattern will continue playing after you release your hand from the keyboard. You can stop playback either by pressing that key once again, or by pressing a key in the area of C2 or below.

Shutdown Keys:

When you play a key in the range of C-1 – C2, the currently-playing pattern will stop.

Pattern Assignable:

A pattern and track can be assigned to each of the 72 keys in the range of C#2–C8. If you do not assign a key, it can be used to play as usual.

As in the example shown in the following diagram, you can make one key play a drums pattern, another key a bass phrase, and yet another key play guitar chords, all by specifying a different pattern and track for each key.

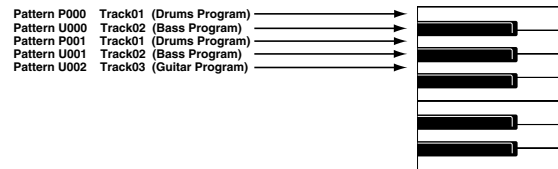
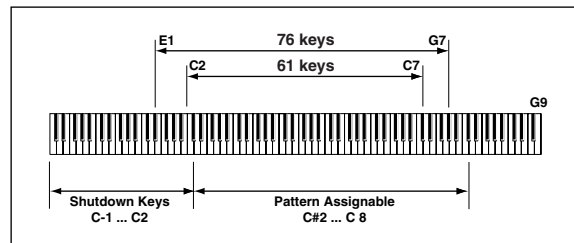

Simple program editing

By operating the performance editor and the realtime controllers you can easily and intuitively modify the sound of a program.

Program editing refers to the process of modifying the parameters that make up a program, in order to modify the sound or change the controller, effect settings etc.

note More detailed editing can be performed in PROG 2.1: Ed-Basic – 7.2: Ed-MasterFx.

Performance Edit

By using the eight sliders of the Performance Editor, you can make overall adjustments to the sound. When you move a slider, multiple program parameters are adjusted simultaneously.

① Press the [PROG] key (the key will light) to enter Program mode.

② Press the [F2] (“P.Edit”) key.

The Perform. Edit page will appear.

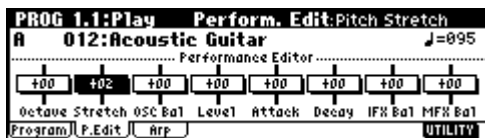

③ Select the Program.

④ Use the Performance Editor to adjust the sound. (see PG p.3)

Use the cursor keys [▲], [◀], [▼], [▶] to select the desired performance editor slider, and use the VALUE controller to adjust the setting.

note If you want to reset the value, press numeric key [0] and then press the [ENTER] key to restore the previous setting.

Octave: Indicates the octave setting.

Pitch Stretch: Simultaneously adjusts the transpose and tune settings of the oscillator. This allows you to produce a variety of tonal changes without losing the character of the original sound.

note This is particularly effective for acoustic-type programs such as guitar, bass, or piano. Select various programs and try this out.

OSC Balance: Adjusts the level balance between oscillators 1 and 2.

▲ For programs whose “Mode (Oscillator Mode)” (PROG 2.1: Ed-Basic, Prog Basic page) setting is **Single**, oscillator 2 will not sound. Only the level of oscillator 1 will change. For a **Drums** program, this performance editor will have no effect.

Amp Level: Indicates the amp level. This will adjust the volume of the entire program.

Attack Time: Indicates the attack time of the filter EG and amp EG. This will adjust the speed of the attack from note-on.

▲ In order to maximize the effect of the Attack Time adjustment, the amp EG Start Level, Attack Level, Start Level Modulation, and Attack Time Modulation parameters are also adjusted.

Decay Time: Indicates the decay time and slope time of the filter EG and amp EG.

IFX Balance: This simultaneously adjusts the “W/D (Wet/Dry)” balance of all insert effect.

MFX Balance: This simultaneously adjusts the Return 1 and 2 parameters of the master effects.

▲ Depending on the settings of the program parameters, the result may not be noticeable.

⑤ If you want to save the modified sound, select the utility menu command “Write Program,” and write the program. (see p.42)

It is a good idea to write the program into program number D065 or higher. It is also a good idea to edit the name when you write the program.

note If you want to overwrite the program using the same program number, press the [REC/WRITE] key and then press the [F8] key.

▲ The edited content will be lost if you select another program or turn off the power before saving.

Realtime controls

The REALTIME CONTROLS [1]–[4] knobs can be used to edit parameters such as the filter cutoff frequency, resonance, the amp and filter EG, volume, portamento time, pan, pitch LFO, and master effect send level etc. (see p.24).

You can also modify settings for the arpeggiator. (see p.26)

▲ If CC#70–79 are assigned to REALTIME CONTROLS A-mode or B-mode, the sound edited by knobs [1]–[4] can be saved by the Program Write operation (see p.42). Arpeggiator-related settings in C-mode can also be saved.

Simple combination editing

A combination is a set of multiple (up to eight) programs, and allows you to create complex sounds that could not be produced by a single program.

Combination editing refers to the process of modifying the sound of a combination by changing the program selected for each timbre or adjusting the keyboard range and velocity range, or by modifying the controller, and effect settings.

You can edit a combination in COMBI 2.1: Ed-Prog/Mix-7.2: Ed-MasterFX, but can also make settings for "Program Select," "Pan," and "Volume" in COMBI 1.1 Play as well.

An example of editing

As an example, here's how to do some simple editing on combination **Bank C064: Modern Piano**.

- ① Press the [COMBI] key (the key will light) to enter Combination mode.
- ② Select Bank C064: Modern Piano.



This combination **layers** (simultaneously sounds) the programs of timbre 1 and timbre 2. Timbre 1 sounds **B001: Attack Piano**, a piano with a crisp attack. Timbre 2 sounds **C033: Vintage EP**, a classic electric piano. These two programs are layered to produce a piano-type sound that you may have heard in various contexts.

note A **timbre** consists of a program together with multiple parameters that control that program. A combination can use up to eight of these timbres.

Selecting the program for a timbre

- ③ Select the Prog page.

Press the [F2] ("Prog") key. Now you can specify the programs for timbres 1-8.

- ④ Now let's change the program of timbre 2 to a different program.

Use the cursor keys [▲], [◀], [▼], [▶] to select "Program Select" for timbre 2 (it will be highlighted).



note You can directly select the program for a timbre by holding down the [TIMBRE/TRACK] key and pressing the nearest [F1]-[F8] key. You can select pan or volume in the same way.

For this example, select **A003: Legato Strings**. This is a layered combination with piano and rich strings. Then consecutively press the [A] key, the [3] key, and the [ENTER] key.

Alternatively, the program for a timbre can be selected by category.

Choose "Program Select," and press the [CATEGORY] key.

The Select by Category dialog box will appear.

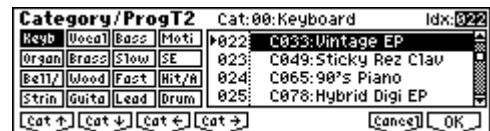

Use the [F1] ("Cat ↑"), [F2] ("Cat ↓"), [F3] ("Cat ←"), and [F4] ("Cat →") keys to select the desired category. For example if you want to select string-type programs rather than the **00: Keyboard** category shown in the above display, press the [F2] ("Cat ↓") key three times to select **03: Strings**. You can use the cursor keys [▲], [▼] to successively select string-type programs. When you are happy with the selected program, press the [F8] ("OK") key to finalize your selection.

Listening to the program sound of just one timbre

- Press the [F8] (“UTILITY”) key to access the utility menu, and press the [F7] key to choose “Solo Selected Timbre.” Press the [F8] (“OK”) key.



Now you will hear only the program sound of the currently selected timbre. The lower part of the LCD screen will indicate [Solo].



To cancel this setting, choose “Solo Selected Timbre” once again and press the [F8] (“OK”) key.

Adjusting the stereo location of the sound

- ⑤ Select the Mixer page.

Press the [F3] (“Mix”) key. Here you can adjust the pan and volume for timbres 1–8.



- ⑥ Adjust the stereo location in “Pan” of timbre 2.

Use the cursor key [▲], [◀], [▼], [▶] to choose “Pan” (highlighted) for timbre 2.

Use the VALUE controller to change the value.

A setting of C064 is center, L001 is far left, and R127 is far right. With a setting of RND, the stereo location will change randomly between left and right each time a note is played.

Adjusting the volume

- ⑦ Adjust the “Volume” of timbre 2.

Use the cursor key [▲], [◀], [▼], [▶] to choose “Volume” (highlighted) for timbre 2.

Use the VALUE controller to change the value.



Adjusting the volume while preserving the volume balance between timbres

- Press the [F8] (“UTILITY”) key to access the utility menu, and press the [F7] key to choose “Hold Balance.” Press the [F8] (“OK”) key.



The upper right of the LCD screen will indicate “Hold Bal.”



When you change the “Volume” value of any timbre, the volume of all timbres will also change to preserve the volume balance at the time you checked the Hold Balance setting.

To cancel this setting, choose “Hold Balance” once again and press the [F8] (“OK”) key.

Writing the combination

- ⑧ If you want to save the sound you modified, select the utility menu command “Write Combination,” and write it. (p.42)

It is a good idea to edit the name when you write the combination.

- note** If you want to overwrite the edited combination onto the same combination number, press the [REC/WRITE] key and then press the [F8] key.

- !** The edits you make will be lost if you select another combination or turn off the power before saving.

Sampling (recording a sample)

If the EXB-SMPL option (sold separately) is installed, you will be able to record 48 kHz 16 bit stereo samples. Sampled sounds can be used in a program, combination, or song.

Here we will explain the process of making sampling settings, recording the actual sample, saving it, and converting a multisample into a program. We will also explain how a sample such as a drum phrase can be played back repeatedly. For other procedures and more detailed explanations, refer to p.84 and PG p.87.

Note In order to perform the steps described below, the EXB-SMPL option must be installed. (PG p.253)

Sampling a sound and playing it back as "one-shot"

1. Connect a mic and make input settings

① Turn off the power. Then turn it on again.

Note When you turn off the power, all unsaved sample data will be erased. If you want to keep any of the sample data, save it before you continue.

Note This explanation assumes that you are starting from the initial power-on state.

② Connect a mic to the AUDIO INPUT 1 jack located on the rear panel of the EXB-SMPL.

Set the AUDIO INPUT [MIC/LINE] switch to the MIC position, and set the [LEVEL] knob to the center.

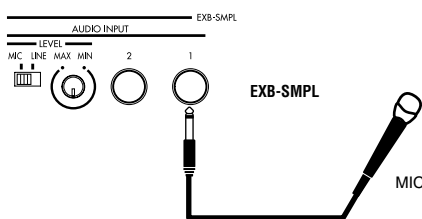

③ Press the [SAMPLING] key to enter Sampling mode.

Note If the EXB-SMPL option is not installed, the display will indicate "No Sampling Upgrade Installed," and it will not be possible to enter this mode.

④ Press the [F3] ("In/Pref") key to select the SMPL 1.1: Recording, Input/Pref page.



⑤ In the Input1 area, set "BUS" to L/R, specifying the bus to which the AUDIO INPUT 1 jack will be input.

Make sure that the Input1 level ("Lvl") is 127, and the "Pan" is L000.

Note Be aware that when "BUS" is changed from Off to L/R or IFX, the volume level to the AUDIO OUT L/MONO and R jacks or to the headphones may rise abruptly.

2. Set the recording level

① Speak into the mic at the volume that you will use for recording.

If the display indicates "ADC OVER!" (AD converter input overload!), turn the rear panel [LEVEL] knob in the direction of MIN to adjust the level appropriately.

Note For the ideal audio quality, the level should be slightly lower than when the "ADC OVER!" display appears (i.e., the highest level that does not produce an overload).

② Press the [REC/WRITE] key.

Speak into the mic at the volume that you will use for recording.

The level meter will show the input volume.

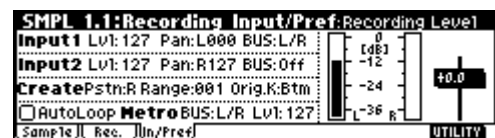

If the display indicates "CLIP!," use the VALUE controller to lower the "Recording Level" slider (located in the right of the display) from the +0.0 setting down to an appropriate level.

③ When you have finished making adjustments, press the [REC/WRITE] key.

3. Specify the recording method (Auto)

① In the lower left of the SMPL 1.1: Recording, Input/Pref page, select the "Auto Loop On" check box, and press the [DEC] key to un-check it.

② Press the [F2] ("Rec.") key to select the SMPL 1.1: Recording, Recording page.



③ In REC Setup, set "Mode (REC Mode)" to "Auto," and set "Threshold" to -30.

With this setting, recording will begin automatically when the audio input reaches -30 dB or higher in record-ready mode.

Set "Pre Trigger" to 5 ms.

With this setting, sample recording will begin 5 ms earlier than (i.e., immediately before) sampling is actually triggered, so that the very beginning of the sound is not lost.

note As an alternative to the **Auto** setting for "Mode (REC Mode)," you can set this to **Manual** and record manually. (p.38)

- ④ In **Sample Setup**, set "Mode (Sampling Mode)" to **L-Mono**.

With this setting, the internal L channel will be sampled in mono.

4. Create a multisample and indexes

- ① Press the [F1] ("Sample") key to select the **SMPL 1.1: Recording, Sample** page.

Immediately after the power has been turned on, 000 will be selected as the multisample "MS."

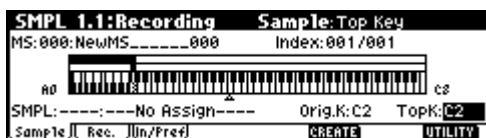

note If you want to create a new multisample, use the numeric keys to input the number of the multisample that you want to create, and press the [ENTER] key.

- ② Set "Orig.K (Original Key)" and "TopK (Top Key)" to **C2** (p.30).

When you play the key designated by "Orig.K," the sample will sound at the same pitch at which it was sampled.

note You can make this setting easily by holding down the [ENTER] key and pressing the C2 key.

- ③ Press the [F3] ("In/Pref") key to access the **SMPL 1.1: Recording, Input/Pref** page.

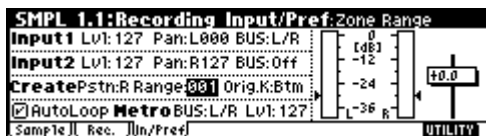

- ④ Set **Create "Range (Zone Range)"** to 001.

When you create a new index, the width of the zone will be set to one key.

5. Record a sample

- ① Press the [F1] ("Sample") key to access the **SMPL 1.1: Recording, Sample** page.

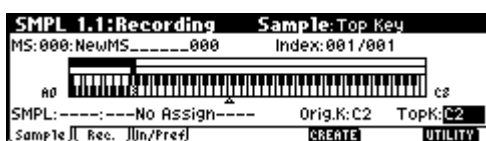

- ② Press the [REW/WRITE] key. Press the [START/STOP] key to enter record-ready mode.

Speak the word that you want to sample. (Example: "It's")

Recording will start when the input exceeds the "Threshold" level.

When you finish speaking, press the [START/STOP] key to stop sampling.

A sample has now been created. The sample you recorded is automatically assigned to "SMPL."

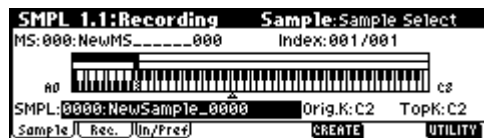

You can listen to the sampled sound by playing the "Orig.K" note or pressing the [AUDITION] key.

- ③ Press the [F6] ("CREATE") key to create a new index.
- ④ Press the [REC/WRITE] key. Press the [START/STOP] key. Speak the word that you want to sample. (Example: "So") When you finish speaking, press the [START/STOP] key to stop sampling.
- ⑤ Repeat steps ③ and ④ to record additional samples. (Example: "Easy," "To," "Sample," "With" "TRITON Le")
- ⑥ Play consecutive notes on the keyboard.

Play a chromatic scale upward, starting at the C2 key. The samples you recorded will be played one after another.

(In this example, playing notes C2 through F#2 in sequence will produce "It's So Easy To Sample With TRITON Le")

Using the insert effect while you sample

- ① In step ⑤ of the preceding section "1. Connect a mic and make input settings," set the **Input1 "Pan"** to C064, and "BUS" to IFX.

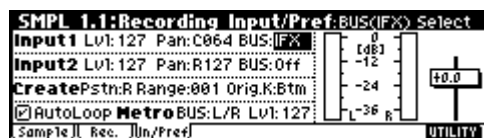

- ② Press the [MENU] key to access the **PAGE MENU**.



Press the [F7] ("IFX") key, and then press the [F8] ("Open") key.

The **SMPL 7.1: Insert Effect, Setup** page will appear.

- 3 Select "Insert Effect," use the numeric keys to enter 52, and press the [ENTER] key to confirm 52: Rev Hall.

Select "IFX On/Off," and press the [INC] key to turn it ON.

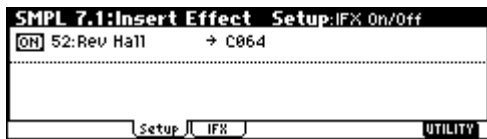

- 4 Speak into the mic, and verify that reverb is applied to the sound.
You can adjust the effect settings in the IFX page ([F4] key).
- 5 After pressing the [EXIT] key, press the [F2] ("Rec.") key to access the SMPL 1.1: Recording, Recording page.



- 6 In Sample Setup, set "Mode (Sample Mode)" to Stereo.
Now the sound of the internal LR channels can be sampled in stereo.
- 7 Press the [F1] ("Sample") key, and then press the [F6] ("CREATE") key to create a new index.
- 8 Press the [REC/WRITE] key.
Press the [START/STOP] key, and speak the word(s) that you want to sample.
Recording will begin according to the "Threshold" setting.
Press the [START/STOP] key to stop.
- 9 Play the keyboard.
When you play the "Orig.K" note or press the [AUDITION] key, the sampled sound will be heard.

Assigning a name to the sample or multisample

The TRITON Le allows you to create up to 4,000 samples and 1,000 multisamples (limited by the amount of memory). It is a good idea to assign names so that you can distinguish individual samples and multisamples.

Naming a multisample

- 1 Press the [F1] ("Sample") key to access the SMPL 1.1: Recording, Sample page.
- 2 Select "MS," and use the [INC]/[DEC] keys to select the multisample to which you want to assign a name.
- 3 Press the [F8] ("UTILITY") key to access the utility menu, use the [F7] key etc. to select "Rename MS,"

and press the [F8] ("OK") key.

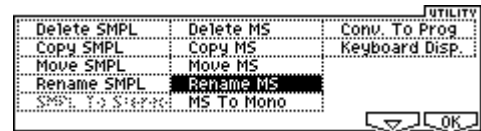

A dialog box will appear.



Press the [F5] ("Name") key to display the text dialog box, and assign a name of SMPL_Demo.



Press the [F1] ("Clear") key.

Input the first character. Use the [VALUE] dial and the [INC]/[DEC] keys or [▲], [▼], [↵], [▶] keys to select "S".

Input the second character. Press the [F6] key. Use the [VALUE] dial and the [INC]/[DEC] keys or [▲], [▼], [↵], [▶] keys to select "M".

Repeat these steps to input all of the characters, and then press the [F8] ("OK") key twice. (esp.43)

note A stereo multisample will have a -L and -R displayed at the end of the name, meaning that you will be able to input 14 characters. (The -L and -R are fixed.) You can input 16 characters for a mono multisample. This also applies to samples.

Naming a sample

- 1 Press the [F1] ("Sample") key to access the SMPL 1.1: Recording, Sample page.
- 2 Select "Index," and use the [INC]/[DEC] keys to select the sample to which you want to assign a name.

For this example, select "Index" 001.

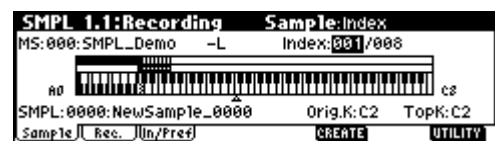

It is also possible to select a sample in "SMPL," but since the sample assigned to each index can change, you should use "Index" to select a sample.

- 3 Press the [F8] ("UTILITY") key to access the utility menu, use the [F7] key etc. to select "Rename SMPL," and press the [F8] ("OK") key.

When the dialog box appears, press the [F5] ("Name") key to access the text dialog box, and assign the desired sample name. (Example: "It's") Refer to step 3 of "Naming a multisample."

- 4 Select "Index," select the next sample that you want to name, and use the utility menu command "Rename SMPL" to assign a name to that sample.

Saving sample data

Here's how to save a sample or multisample that you created.

 All samples and multisamples in the TRITON Le will be lost when the power is turned off.

- ① Insert a SmartMedia card into the slot. Alternatively, make sure that settings are made correctly for a connected external SCSI device.
- ② Press the [MEDIA] key to select Media mode.
- ③ Press the [F2] ("Save") key.



- ④ If you want to save to a different device, use the media select setting (Media:) to select the device on which you want to save the data.
- ⑤ Press the [F8] ("UTILITY") key to access the utility menu, and press the [F7] key to select "Save Sampling Data." Press the [F8] ("OK") key to display the following dialog box.

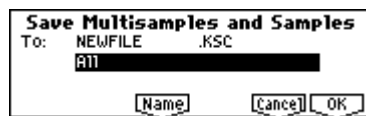

- ⑥ Press the [F5] ("Name") key to access the text dialog box, assign a filename of SMPL_DM1, and press the [F8] ("OK") key.
- ⑦ Make sure that All is selected for the "To:" field, and press the [F8] ("OK") key to save the data.

When saving is completed, a file with an extension of .KSC together with .KMP and .KSF files in folders will be saved. For details on each file, refer to PG p.144 "About Korg format PCM data files."

Converting a multisample into a program

A multisample you created can be converted into a program. By converting the data into a program, a sample or multisample you created in Sampling mode can be used in Program mode, Combination mode, or Sequencer mode.

- ① Create a multisample. (☞ p.35)
- ② Press the [F1] ("Sample") key to access the SMPL 1.1: Recording, Sample page.
- ③ Press the [F8] ("UTILITY") key to access the utility menu.

Press the [F7] key to select "Conv.To Prog," and press the [F8] ("OK") key.

The following dialog box will appear.



- ④ In the "To:" field, select the program into which the data will be converted.
Bank D064–127 contains initialized programs. We recommend you select one of these programs.
-  When you execute the Convert operation, the program in the conversion destination location will be overwritten and replaced by the converted program.
- ⑤ Set the "Use Destination Program Parameters" setting.

For this example, **uncheck** this. If you execute conversion with this unchecked, the program will be created with the sound that you heard in Sampling mode.

- note** If you want to use the program parameters of a preloaded program (A000–D063), copy that program to bank D064–127 before you perform this operation. Use the "To:" field to select that program, and check "Use Destination Program Parameters" before you perform the conversion. However if you want to convert a stereo multisample with "Use Destination Program Parameters" checked, you must change the "Mode (Oscillator Mode)" to **Double** for the conversion destination program ("To") before executing the conversion.
- ⑥ As necessary, press the [F5] ("Name") key to access the text dialog box and assign a program name. Press the [F8] ("OK") key. A dialog box will ask you for conformation. Press the [F8] ("OK") key once again, and the conversion will begin.
- ⑦ Listen to the converted program.
Move to Program mode, select the program (D064 in the above example), and play the keyboard to hear the sound.

 The converted program settings will automatically be stored in internal memory, but the sample data you created will be lost when the power is turned off. In order to reproduce the sound of the program after the power is turned on again, you must first load the previously-saved sample data in Media mode. When loading, it is best to set ".KSC Allocation" to **Clear**. When saving, it is a good idea to execute "Save All" (☞ PG p.148) to save the samples and multisamples along with the converted program, and then load all of this data together. (☞ PG p.141, 145)

Sampling and looping a drum phrase

Here's how you can sample a drum phrase (or similar phrase) from an audio CD, and loop the playback.

You will need to provide a drum rhythm loop sample. Initially, it is a good idea to begin with a rhythm loop sample that has a fairly simple beat. As an example, we will sample one measure of a 140 BPM drum phrase in a 4/4 time signature.

1. Connect your external audio device and make input settings

- 1 Turn off the power. Then turn it on again.

⚠ When you turn off the power, all sampling data will be erased. Be sure to save any important data before you perform this step.

note This explanation assumes that you are starting from the default state immediately after power-on.

- 2 Connect the AUDIO INPUT 1, 2 jacks on the rear panel of the EXB-SMPL to the AUX OUT L and R jacks of your CD player.

Set the AUDIO INPUT [MIC/LINE] switch to the LINE position, and set the [LEVEL] knob near the center.

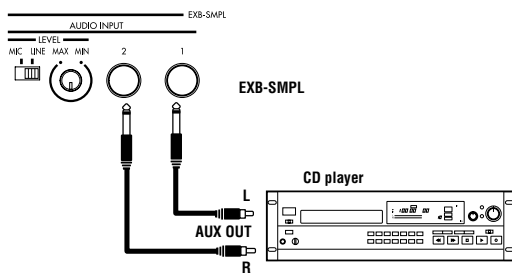

- 3 Press the [SAMPLING] key to enter Sampling mode.
- 4 Press the [F3] ("In/Pref") key to select the SMPL 1.1: Recording, Input/Pref page.

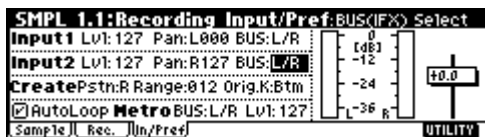

- 5 Set various parameters so that the signal from the AUDIO INPUT jacks will be input to the TRITON Le.

Make the following settings.

Input 1: "Lvl" 127, "Pan" L000, "BUS" L/R
 Input 2: "Lvl" 127, "Pan" R127, "BUS" L/R

⚠ When you change the setting from Off to L/R or IFX, the volume level of the AUDIO OUT L/MONO and R jacks or the headphone volume may rise abruptly. Please use caution.

2. Set the recording level

- 1 Play back the audio source that you want to record.

If the display indicates "ADC OVER!" (AD converter input overload!), lower the level by turning the rear panel [LEVEL] knob to an appropriate position. Alternatively, lower the level of the output source.

note The best audio quality will be obtained at a level slightly lower than when the "ADC OVER!" indication appears (i.e., the highest level that does not cause an input overload).

- 2 Press the [REC/WRITE] key.

The level meter allows you to check the volume of the input.

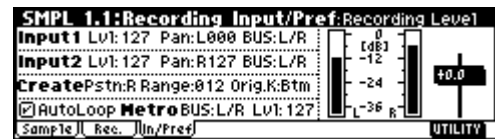

If the display indicates "CLIP!," use the VALUE controller to lower the "Recording Level" slider (located in the right of the display) from the +0.0 position to an appropriate level.

- 3 When you have finished making adjustments, press the [REC/WRITE] key. Also stop playback of your audio source.

3. Specify the recording method (Manual)

- 1 Press the [F2] ("Rec.") key to access the SMPL 1.1: Recording, Recording page.



- 2 In REC Setup, set "Mode (REC Mode)" to Manual to specify how recording will begin.

note As an alternative to setting "Mode (REC Mode)" to Manual and recording manually, you can select Auto for automatic recording. Recording can be performed using either method. (p.34)

- 3 In Sample Setup, set "Mode (Sample Mode)" to Stereo.

With this setting, the sound of the internal LR channels can be sampled in stereo.

4. Record the sample

- 1 Press the [F1] ("Sample") key to access the SMPL 1.1: Recording, Sample page.

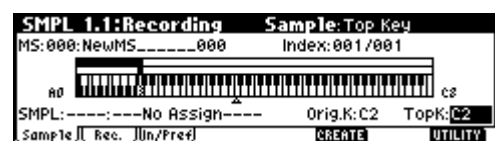

- 2 Press the [REC/WRITE] key.

- ③ At the moment that you wish to start sampling, press the [START/STOP] key.

Sampling will start.

note It is a good idea to allow a bit of extra time before you start and after you stop sampling.

- ④ At the moment that you wish to stop sampling, press the [START/STOP] key.

Sampling will stop.

A 140 BPM drum phrase has now been sampled. The sample will automatically be assigned to "SMPL."

! Sampling will stop automatically if the remaining amount of memory reaches zero.

- ⑤ Listen to the sampled sound, and assign a name to the sample.

Press the C2 note or the [AUDITION] key, and the sampled sound will play. After you have verified the sound, assign a name to the sample (esp. 36) (e.g., LOOP1-140 BPM). Up to 14 characters can be input as the name of a stereo sample (the two characters -L and -R at the end are fixed). When you assign a name to either the L or R channel, the other sample will be named automatically.

5. Make loop settings

Next we will delete unwanted portions from the sample, and make settings so that the sample will be looped smoothly.

note By default when the power is turned on, sampled sounds will be looped automatically. (1.1: Recording, Input/Pref page "Auto Loop On" On)

- ① Press the [MENU] key to access the page menu. Press the [F3] key, and then press the [F8] ("Open") key to select 3.1: Loop Edit.

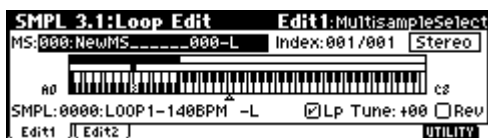

- ② Notice that 0000: LOOP1-140BPM -L is selected for "SMPL."

- ③ Press the [F2] ("Edit2") key to access the Edit2 page.

The waveform data of the currently selected sample will be displayed.



note The selected sample is a stereo sample. The L and R waveforms will be displayed alternately when you press the [F3] ("L/R") key.

- ④ Use "S (Start)" to set the start address, "LpS (Loop Start)" to set the loop start address, and "E (End)" to set the end address.

The sample will sound as follows.

When looping is on: S → E → LpS → E → (continue repeating LpS → E)

When looping is off: S → E

Use the [◀], [▶] to select "S (Start)" (highlighted), and use the [VALUE] dial etc. to specify the location at which the sample will begin sounding. The vertical line in the display will move accordingly.

note As necessary, you can press the [F4]–[F7] keys to expand or shrink the waveform display. Zoom will expand/shrink the display starting at the selected "S (Start)," "LpS (Loop Start)," or "E (End)" points.

If you check "Zero (Use Zero)," locations where the waveform is at zero will automatically be found and selected when you use the [VALUE] dial etc. to set "S (Start)," "LpS (Loop Start)," or "E (End)" points. This makes it easy to set these points to addresses that will not produce clicks or noise.

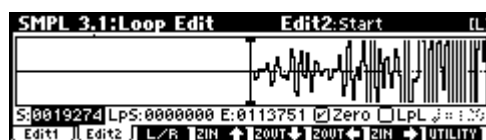

For this example, set "LpS (Loop Start)" and "S (Start)" to the same value.

note If desired, you can make a dotted vertical line appear in the sample waveform display to indicate the BPM. If you use this function with waveforms that have a specific BPM, it will be easier to make accurate settings for "E (End)."

Press the [F8] ("UTILITY") key to access the utility menu, and press the [F7] key to select "Grid."

Press the [F8] ("OK") key. The following dialog box will appear.

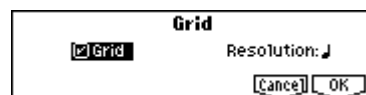

Check "Grid," set "Resolution" to ♩, and press the [F8] ("OK") key. Set "♩ (Grid Tempo)" to 140. With these settings, vertical dotted lines will be displayed at 140 BPM quarter note intervals.



Set "E (End)."

When "Lp (Loop)" is On, the dotted vertical "Grid" lines will start at "LpS (Loop Start)." If you want to set "End" at the end of one 4/4 measure, the fourth vertical line from the "LpS (Loop Start)" line will be the end of the first measure. Place "E (End)" at this vertical line.



-
- ⑤ Use "Truncate" to delete the unwanted data that is outside of the start (or loop start) and end addresses.

Press the [F8] ("UTILITY") key to access the utility menu, and press the [F7] key to select "Truncate." Press the [F8] ("OK") key. The following dialog box will appear.



Set "Truncate" to **Front & End**. In this example, we will not change the settings of the "Save to No." and "Overwrite" check boxes, so press the [F8] ("OK") key to execute. When you execute the operation, the truncated samples **0002: LOOP1-140B0002-L** and **0003: LOOP1-140B0002-R** will be automatically assigned to Index 1.

- ⚠ Please refer to "A note on saving samples" (p.90) for a cautionary note regarding the "Save to No." and "Overwrite" check boxes.

Basic functions

Saving data

Types of data that can be saved

On the TRITON Le, there are three ways to save data: **writing to internal memory**, saving on **external media** (SmartMedia etc.), and **MIDI data dump**.

Writing to internal memory

The following data that you edit can be written into internal memory.

- **Program**
Programs 0–127 in banks A–D
- **Combination**
Combinations 0–127 in banks A–C
- **Global settings** (Page 1.1–4.1)
- **User drum kits** 00 (INT)–23 (User)
- **User arpeggio Patterns** 000 (INT)–215 (User)
- **User template songs** U00–U15
Song settings such as the song name and tempo, track settings (see p.62), arpeggiator settings, and effect settings can be saved (Write) to internal memory. However, the musical data for song tracks and patterns are not saved to internal memory. Furthermore, settings that govern how the musical data is played back such as “Meter,” “Metronome,” “Play/Mute,” “Track Play Loop (including Start/End Measure),” and RPPR settings will not be saved either. Use the Sequencer mode Utility menu command “Save Template Song” to write this data (see PG p.53).

⚠ Data that you edit in Sequencer or Sampling mode cannot be saved in internal memory by the Write operation.

⚠ If the EXB-SMPL (sold separately) option is installed, and you are using RAM bank multisamples or samples as the **Multisample** or **Drum Kit** of a program, it is not possible to write this multisample or sample data (i.e., to save it permanently). This means that the sound of a program or combination that uses RAM bank multisamples or samples will not be reproduced the next time the power is turned on. In order to reproduce these sounds, the saved multisamples and samples must be loaded from external media (e.g., SmartMedia).

Saving to external media (SmartMedia etc.)

The following data can be saved on external media (SmartMedia etc.). If the EXB-SMPL option is installed, this data can also be saved on high-capacity media such as a hard disk etc.

The following data can be saved.

For details on the file format, refer to PG p.139.

- **Programs, combinations, global settings, user drum kits, and user arpeggio patterns**
- **Song and cue lists**
- **Standard MIDI Files (SMF)**
Sequencer mode songs can be saved as SMF data.
- **System exclusive data**
System exclusive data received by the TRITON Le from an external MIDI device (The TRITON Le can function as a data filer.)
- **Multisamples and sample data created in Sampling mode (if the EXB-SMPL option is installed)**

MIDI data dump

The following types of data can be transmitted as a MIDI data dump and saved on an external data filer or other device.

- **Programs, combinations, global settings, user drum kits, and user arpeggio patterns**
- **Songs, cue lists**

About preloaded data and preset data

Preloaded data is the data that is loaded into memory at the factory. This data can be rewritten, and is written into the various locations listed in the preceding section “Writing to internal memory.” This data is maintained inside the TRITON Le, and can be reloaded using the “Load Preload/Demo Songs” command (see p.47).

- **Program** banks A–C: 000–127, D: 000–063
- **Combination** banks A–C: 000–127
- **User drum kits** 00 (INT)–15 (INT)
- **User arpeggio patterns** 000 (INT)–199 (INT)
- **Demo songs** 000–001

Preset data is data that cannot be rewritten by the Write operation. This includes the following data.

- **Program** banks G: 001–128, g(d): 001–128
- **Preset drum kits** 64 (GM)–72 (GM)
- **Preset arpeggio patterns** P000–P004
- **Preset template songs** P00–P15
- **Preset patterns** P000–P149
- **Program audition riffs** 000–383

Writing to internal memory

Memory protect

To prevent programs, combinations, songs, user drum kits, and user arpeggio patterns from being overwritten accidentally, the TRITON Le provides a Memory Protect setting that prohibits writing to memory. Before you save edited data or load data from SmartMedia or other external media (if the EXB-SMPL option is installed), use the following procedure to turn off memory protect (uncheck the appropriate check box).

You must also turn memory protect off before loading the above data from SmartMedia or via MIDI data dump, or before recording in Sequencer mode.

- 1 Press the [GLOBAL] key to enter Global mode (the key will light), and press the [EXIT] key to select 1.1: System.
- 2 Press the [F2] ("Pref.") key to access the 1.1: System, Preferences page.

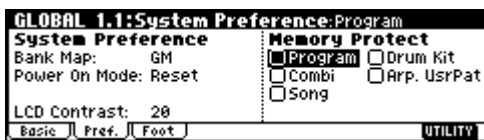

- 3 Uncheck the appropriate "Memory Protect" check box for the data that you wish to write into internal memory.

Writing a program or combination

The programs or combinations that you create by using the Performance Editor or by editing parameters in the various edit (Ed) pages can be saved in the internal memory of the this instrument. This action is referred to as "writing a program" or "writing a combination." If you want your edited data to be preserved after the power is turned off, you must write it.

There are two ways to write a program or combination.

- Before you write data into memory, you must turn off the memory protect setting in Global mode. (☞ "Memory protect")
- A combination does not contain the actual program data for each timbre, but simply remembers the number of the program used by each timbre. If you edit a program that is used by a combination, or exchange it with a different program number, the sound of the combination will also change.

Using a Utility menu command to write

- 1 Select the Utility menu command "Write Program" or "Write Combination."
- The Write Program/Write Combination dialog box will appear.

note You can also access the same dialog box by holding down the [ENTER] key and pressing the [0] key.

The screen shown is for Program mode

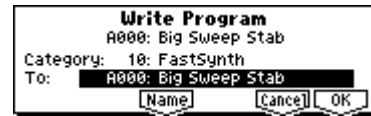

- 2 In "Category," specify the category of the program/combination.

If the category you specify here is for a program, you can use it when selecting by category in the Cat. Hold function or the Utility menu command "Select by Category" PROG 1.1: Play, Program page ("Program Select") in the COMBI 1.1: Play, Prog page ("Program Select"), the COMBI 2.1: Ed-Prog/Mix, Prog page, or the SEQ 1.1: Play, Program page Utility menu command "Select by Category."

In the case of a Combination, the category you specify here can be selected when you use the Utility menu command "Select by Category" or the Cat. Hold function in COMBI 1.1: Play: ("Combi Select").

- 3 Use "To" to specify the bank and number of the writing destination program/combination.

Use the VALUE controller to specify the destination.

- 4 If you wish to change the name of the program/combination, press the [F5] ("Name") key.

The text dialog box will appear. Input the name of the program/combination. ☞ "Assigning a name (Rename)"

After you have input the name, press the [F8] ("OK") key to return to the Write Program/Write Combination dialog box.

- 5 To execute the Write operation, press the [F8] ("OK") key. To cancel without executing press the [F7] ("Cancel") key.

When you press the [F8] ("OK") key, the display will ask "Are you sure?" When you press the [F8] ("OK") key once again, the data will be written.

Using the [REC/WRITE] key to write

This method can only be used to write to the selected program/combination number.

- 1 Press the [REC/WRITE] key.

The following dialog box will appear.

The screen shown is for Program mode



- 2 To write the data, press the [F8] ("OK") key. To cancel without writing, press the [F7] ("Cancel") key.

Assigning a name (Rename)

You can modify the name of an edited program, combination, song, drum kit, user arpeggio patterns etc..

You can also modify the category names for programs and combinations.

These renaming operations can be performed in the following pages.

Programs	PROG 1.1...7.2 Utility: Write Program
Combinations	COMBI 1.1...7.2 Utility: Write Combination
Song	SEQ 1.1...4.4, 6.1 Utility: Rename Song
Cue list	SEQ 2.1 Utility: Rename Cue List
Tracks	SEQ 5.1, 5.2 Utility: Rename Track
Patterns	SEQ 5.1 Utility: Rename Pattern
Multisamples*	SMPL 1.1...4.1, 5.2 Utility: Rename MS
Samples*	SMPL 1.1...4.1, 5.2 Utility: Rename SMPL
Drum kits	GLOBAL 5.1 Utility: Rename Drum Kit
User arpeggio patterns	GLOBAL 6.1 Utility: Rename Arpeggio Pattern
Program categories	GLOBAL 4.1: TEXT
Combination categories	GLOBAL 4.1: TEXT
File	MEDIA, Save Utility: Save All...Save Exclusive

*: If the EXB-SMPL option is installed

① Open the text dialog box.

Refer to the above table for the relevant page.

In the Utility menu commands, press "Name" (the [F5] key) in the dialog box that appears.

In GLOBAL 4.1, select "TEXT" (press the [F5] key).



For example if you wish to input the text shown in the screen shown above, you would use the following procedure.

② Press the [F1] ("Clear") key.

All text of the text box will be erased.

③ Input "A"

Use the [VALUE] dial, the [INC]/[DEC] keys, or cursor keys [▲], [◀], [▼], [▶] to select "A."

Press the [ENTER] key or [F6] ("▶") key. The cursor will move.

④ Input "."

Use the [VALUE] dial, the [INC]/[DEC] keys, or cursor keys [▲], [◀], [▼], [▶] to select "."

Press the [ENTER] key or [F6] ("▶") key. The cursor will move.

Repeat this step to input all the characters.

⑤ Press the [F8] ("OK") key.

If you selected "Name" in the dialog box of step ① to access the text dialog box, you will return to the previous dialog box. Press the [F8] ("OK") key in that dialog box to execute the Rename operation.

If you selected "TEXT" in step ① to access the text dialog box, the Rename operation will be executed.

The function buttons will have the following functions.

Clear: Erase all text.

Del (Delete): Delete the character at the cursor location.

Ins (Insert): Insert a space at the cursor location.

Cap. ⇄ (Capital): Switch between uppercase and lowercase letters.

◀: Move the cursor to the left.

▶: Move the cursor to the right.

The following input operations can also be performed.

"0"–"9," "-", and "." can be input using the numeric keys. When you input these, the cursor will advance automatically.

By pressing the [ENTER] key at the space (blank), you can input the selected text before the space.

About the Edit Buffer

When you select a program or combination in PROG 1.1: Play and COMBI 1.1: Play, the program or combination data is called into the "edit buffer."

When you modify the parameters in 1.1: Play or in the Edit pages 2.1–7.2 of Program mode or Combination mode, the changes you make will affect the data in the edit buffer.

If you wish to save this modified data into internal memory, you must perform the Write operation. When you perform the Write operation, the data in the edit buffer is written to the specified program number or combination number of the specified bank.

If you select another program or combination without writing, the data of the newly selected program or combination will be called into the edit buffer, and your changes will be lost.

- When you press the [COMPARE] key in Program mode or Combination mode, the data from memory (i.e., the contents that were written into memory) will be temporarily called into the edit buffer. This allows you to compare the settings you are editing with the original un-edited settings.

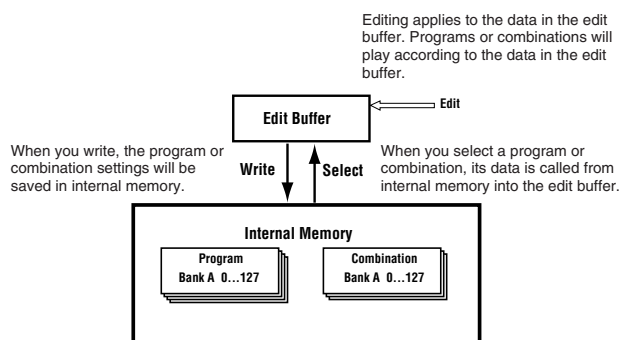

..... Writing global settings, user drum kits, and user arpeggio patterns

The settings you edit in Global mode can be written into internal memory. This is done using the operations **Write Global Setting**, **Write User Drum Kits**, and **Write User Arpeggio Patterns**. If you wish to use these settings after turning the power off, be sure to write the data.

There are two ways to write global settings, user drum kits, and user arpeggio patterns.

⚡ Before you write a user drum kit or user arpeggio pattern, the Global mode memory protect setting must be turned off (☞“Memory protect”).

⚡ The user arpeggio pattern settings “Tempo,” “Pattern,” “Octave,” “Resolution,” “Sort,” “Latch,” “Key Sync,” and “Keyboard” are parameters that are set independently in Program, Combination, and Song. These settings are not saved when you perform the Write operation described here. If you moved from Program or Combination mode and set these parameters, you must return to the original mode and write them.

Using a Utility menu command to write

- ① To write global settings (the various settings in GLOBAL 1.1–4.1), select the Utility “Write Global Setting” in GLOBAL 1.1–4.1, and press the [F8] (“OK”) key.

The Write Global Setting dialog box will appear.



To write user drum kits, select the Utility “Write Drum Kits” in GLOBAL 5.1, and press the [F8] (“OK”) key.

The Write Drum Kits dialog box will appear.

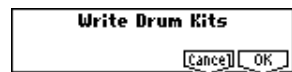

To write user arpeggio patterns, select the Utility “Write Arpeggio Patterns” in GLOBAL 6.1, and press the [F8] (“OK”) key.

The Write Arpeggio Patterns dialog box will appear.

The example shown is for Write Arpeggio Patterns

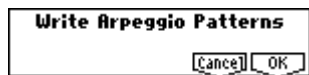

note The same dialog box will also appear if, in each of the above pages, you hold down the [ENTER] key and press the [0] key.

- ② To execute the Write operation, press the [F8] (“OK”) key. To cancel, press the [F7] (“Cancel”) key.

When you press the [F8] (“OK”) key, the display will ask “Are you sure?” Press the [F8] (“OK”) key once again to write the data.

Using the [REC/WRITE] key to write

- ① In the following pages, press the [REC/WRITE] key. A dialog box will appear.

Global settings: GLOBAL 1.1–4.1
User drum kits: GLOBAL 5.1
User arpeggio patterns: GLOBAL 6.1

The example shown is for Update Arpeggio Patterns



- ② To execute the Write operation, press the [F8] (“OK”) key. To cancel, press the [F7] (“Cancel”) key.

Memory in Global mode

When the power is turned on, the Global mode data is called from internal memory into the Global mode memory area. Then when you modify the parameters in Global mode, the data in the memory area will be modified. If you wish to save this modified data in internal memory, you must Write it.

When you write, the data in the memory area will be written into the global settings, drum kits, and arpeggio patterns of internal memory.

If you turn off the power without writing, the modified data in the memory area will be lost.

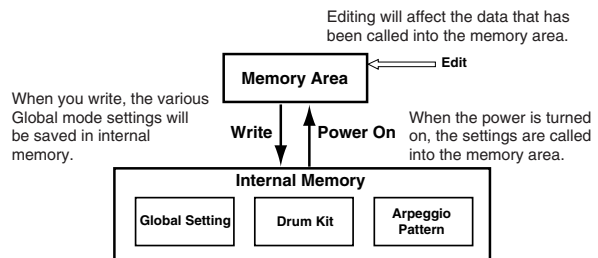

Saving on external media

For details on the data that can be saved on external media (SmartMedia etc.) (see p.41 “Types of data that can be saved”).

▲ Song data and cue lists in the TRITON Le’s Sequencer mode, and multisamples and samples in Sampling mode (if the EXB-SMPL option is installed) cannot be written into internal memory. This data will disappear when the power is turned off. If you wish to keep this data, you must save it on a SmartMedia or on other external SCSI storage media.

Other types of data can also be saved on a SmartMedia, or (if the EXB-SMPL option is installed) on external SCSI storage media (maximum 4 GB), and loaded to restore the original settings even if they have been modified. It is a good idea to save favorite settings that you create.

As an example, we will explain how to save the following data.

- Internal memory programs, combinations, global settings, user drum kits, user arpeggio patterns
- Songs, cue lists
- Multisamples and samples created in Sampling mode (if the separately sold EXB-SMPL option is installed)

▲ If you save this data to SmartMedia, you may need to use more than one SmartMedia card.

① **Insert a SmartMedia card into the SmartMedia slot.**

For details on handling SmartMedia, please be sure to read “Caution when handling SmartMedia” (see p.96).

If the EXB-SMPL option is installed, and you want to save data on external SCSI media such as a hard disk, refer to the manual included with the EXB-SMPL and make sure that the external SCSI device is connected correctly.

You will also need to format the media if necessary. (see PG p.152)

② **Press the [MEDIA] key to enter Media mode.**

③ **Press the [F2] (“Save”) key to access the Save page.**

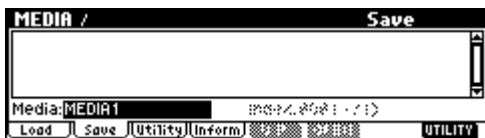

④ **If the media contains directories, select the directory in which you want to save the data.**

To move to a lower level, press the [F6] (“OPEN”) key. To move to a higher level, press the [F5] (“UP”) key.

⑤ **Select the Utility menu command “Save All.”**



Press the [F8] (“UTILITY”) key to access the Utility menu. Press the [F7] key to select “Save All,” and then press the [F8] (“OK”) key.

A dialog box will appear. The contents, settings, and operations for the dialog box will depend on the type of data that you are saving. For details refer to PG p.148.

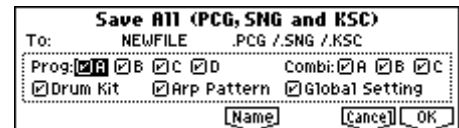

⑥ **Press the [F5] (“Name”) key to display the text dialog box, and input the desired name. (see p.43)**

⑦ **Use the check boxes to uncheck items that you do not want to save.**

In order to accurately reproduce the data you created, we recommend that you check all of the boxes.

⑧ **Press the [F8] (“OK”) key to execute the Save operation.**

The data will be saved to SmartMedia, and you will return to the Save page.

The time required to save the information will depend on the amount of data.

If the SmartMedia contains an identically-named file, you will be asked whether you want to Overwrite. If you want to overwrite, press the [F8] (“OK”) key. If you want to save without overwriting, press the [F7] (“Cancel”) key, repeat the procedure from step ⑤, rename the data in step ⑥, and then save it.

▲ If when saving a .KSC file, the save destination media already contains a directory with the same name as the .KSC file you are attempting to save, a message of “File already exists” will be displayed, and it will not be possible to execute the Save operation.

If this occurs, you can either change the name of the .KSC file you are saving, change the name of the directory on the media, or delete the directory from the media before executing the Save operation.

⑨ **When the data has been saved and you return to the Save page, the LCD screen will show the file that has been saved.**



The data will be saved as the following files.

.PCG file

Programs, combinations, drum kits, user arpeggio patterns, and global settings that were saved in internal memory

.SNG file

Sequencer songs and cue lists

.KSC file

Files listing the multisamples and samples created in Sampling mode (if the separately sold EXB-SMPL option is installed).

Directory

A directory containing the multisamples (.KMP files) and samples (.KSF files) that are listed in the .KSC file

MIDI data dump

The programs (A-D), combinations (A-C), drum kits, user arpeggio patterns and global settings of internal memory, and sequencer songs, cue lists, can be transmitted as MIDI exclusive data and saved on a connected MIDI data filer, computer, or another TRITON Le. (PG p.129)

Other ways to save

In addition to "Save All," the page menu commands include a "Save PCG" command which saves program, combination, drum kit, user arpeggio pattern, and global setting data, a "Save SEQ" command which saves only the sequencer song and cue list data, and a "Save Sampling Data" command which saves only the multisamples and samples of Sampling mode (if the EXB-SMPL option is installed). Select the page menu command that is appropriate for the data you want to save to external media.

note When using "Save All," "Save PCG & SEQ," and "Save PCG" to save combinations, you should also remember to save the programs used by each timbre (and the drum kits used by the programs) and user arpeggio patterns at the same time.

Similarly when saving programs, you should also remember to save the drum kits and user arpeggio patterns used by the programs.

! If your programs or drum kits use multisamples and samples that were created in Sampling mode (using the EXB-SMPL option), we recommend that you use "Save All" to save the data. When you use "Save PCG" or "Save Sampling Data" to individually save a program or drum kit, or a multisample or sample that you created in Sampling mode (using the EXB-SMPL option), we recommend that you save them under the same filename in the same directory. When you use "Load PCG" to load a .PCG file, the identically-named .KSC file will also be loaded so that the correct multisamples/samples will correspond automatically.

! When saving .KSC, .KMP, and .KSF files and the data does not fit on a single SmartMedia (or other volume of media), another dialog box will appear, and you will be asked to specify the next volume of media (PG p.148 "If the data does not fit on the media when saving")

Restoring the factory settings

Loading the preloaded data

The factory settings are referred to as the “preloaded data.” The action of restoring the programs, combinations, and global settings of the TRITON Le to their factory settings is referred to as “loading the preloaded data.”

⚠ This operation will rewrite any data that had been previously written. If you do not want to lose the previously-written data, you must first save it to SmartMedia or external SCSI media (requires the EXB-SMPL option) (see p.45).

- 1 Press the [GLOBAL] key to enter Global mode. (The key will light.)
- 2 Press the [EXIT] key.

You will be in the Global mode 1.1: System page.

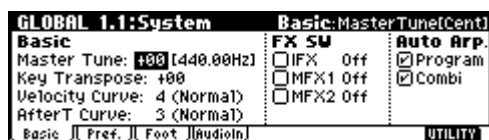

- 3 Press the [F8] (“UTILITY”) key to access the Utility menu.



- 4 Press the [F7] (“”) key to select “Load Preload/Demo Data,” and press the [F8] (“OK”) key.

A dialog box will appear.

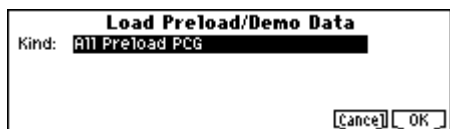

- 5 Use the [INC]/[DEC] keys to select the data that you want to load.

Use “Kind” to select the data that you want to load. For this example, select **All Preload PCG**. .PCG files contain program, combination, drum kit, arpeggio pattern, and global setting data.

- 6 Press the [F8] (“OK”) key.

A dialog box will ask you for confirmation.



- 7 Once again press the [F8] (“OK”) key.

All the preloaded data will be loaded.

⚠ If the Memory Protected dialog box appears, uncheck the memory protect setting, and perform the load operation once again (see p.42).

Loading individual banks or data items

The TRITON Le allows you to load individual banks, programs, or combinations. Drum kits and arpeggio patterns can also be loaded individually or as a group.

This is convenient when you want to restore just one item of factory-set data, or when you want to rearrange combinations in a specific order for live performance.

⚠ It is of course also possible to rearrange programs, but you should be aware that this may change the sounds that are used by a combination (see p.42).

As an example, here’s how to load the combination B015: Rock Organ into A000: Ballad Layer EP.

- 1 Perform steps 1–4 described above to access the dialog box.

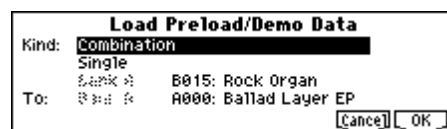

- 2 Use the [INC]/[DEC] keys to set “Kind” to Combination.

- 3 Press the [▼] key to move downward, and use the [INC]/[DEC] keys to select Single.

- 4 Press the [▼] key to move downward, and use the [INC]/[DEC] keys to select the combination B015: Rock Organ as the copy source.

- 5 Press the [▼] key to move downward, and use the [INC]/[DEC] keys to select the combination A000: Ballad Layer EP as the load destination (“To”).

- 6 Press the [F8] (“OK”) key twice.

The data will be loaded, and A000 will be the Rock Organ combination.

Program mode

In Program mode you can select, play and edit programs.

Program mode consists of pages 1.1: Play–7.2: Ed–MasterFX.

In 1.1: Play; you can select and play programs. You can also edit the sound in simple ways, and make arpeggiator settings. (☞p.31)

In 2.1: Ed–Basic–7.2: Ed–MasterFX, you can edit the parameters of the program that was selected in 1.1: Play.

When shipped from the factory, the TRITON Le contains numerous preloaded programs. You can edit these preloaded programs to create your own original programs. You can also create original programs using your own sampled waveforms or multisamples that you sampled in Sampling mode (using the EXB-SMPL option) or loaded into internal memory in Media mode.

note If the separately sold EXB-SMPL option is installed, the TRITON Le will have AUDIO INPUT jacks that allow external audio to be input. In Sampling mode you can sample these external audio input sources. In modes other than Sampling mode, the TRITON Le’s internal effects can be applied to the external audio input sources, allowing a wide range of applications (☞p.111, PG p.126).

note All transmission and reception of MIDI data in Program mode is performed on the Global MIDI channel. The global MIDI channel is set in GLOBAL 2.1: MIDI “MIDI Channel.”

How a program is organized

A program consists of the many parameters of 2.1: Ed–Basic–7.2: Ed–MasterFX. The diagram below shows the structure of a program.

Basic program editing

With the factory settings, this instrument’s program bunks A, B, C and D contain preloaded programs. You can edit these programs to create your own original programs.

note For parameters in 2.1: Ed–Basic–5.3: Ed–LFOs that are set independently for each oscillator 1 and 2, you can use the Utility “Copy Oscillator” to copy settings from one oscillator to the other. This is a convenient way to make the same settings for two oscillators, or to copy settings from one oscillator to the other.

▲ If you wish to save an edited program into internal memory, be sure to Write the program. (☞p.42)

In this section we will give examples of how to modify representative parameters in each page. For details on all parameters, refer to in the PG p.1–.

Programs you edit or create can be written into the 512 program memory areas of banks A–D. They can also be saved and managed on SmartMedia in Media mode (☞p.42).

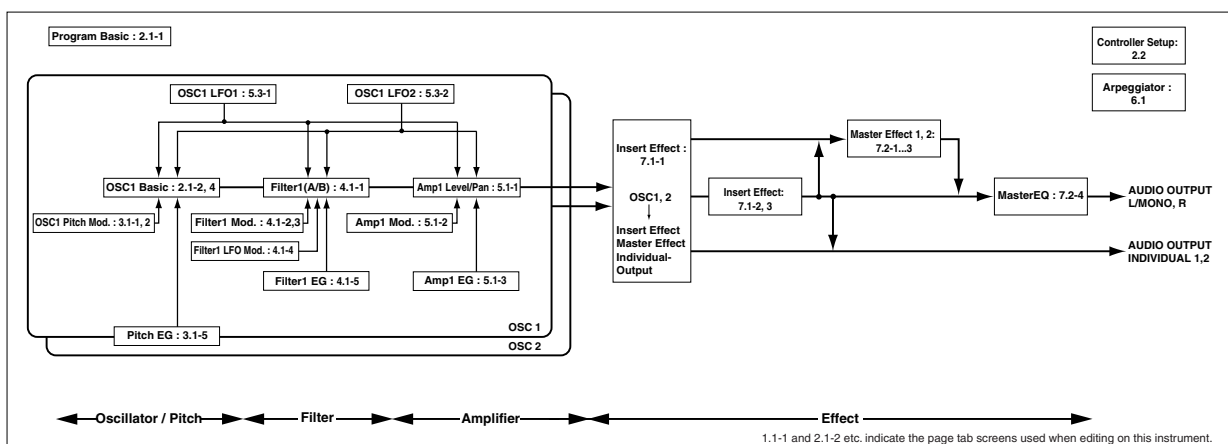

The three elements of sound

Sound can be broken down into three elements: **pitch**, **tone**, and **volume**.

On this instrument, these elements correspond to the **Pitch**, **Filter**, and **Amplifier** settings of the program. In other words you would adjust the Pitch settings to modify the pitch, the Filter settings to modify the tone, and the Amplifier settings to modify the volume.

In **Oscillator** (**Oscillator**: 2.1: Ed-Basic settings) you select the waveform **multisample** that determines the basic sound, and specify its pitch. This sound is then modified by the **pitch** settings (**Pitch**: 3.1: Ed-Pitch), **filter** settings (**Filter**: 4.1, 4.2: Ed-Filter), and **amp** settings (**Amplifier**: 5.1, 5.2: Ed-Amp) to create the basic sound of the program.

This basic sound can then be modified further by using **insert effect** (7.1: Ed-InsertFX settings), **master effects**, and **master EQ** (7.2: Ed-MasterFX settings) to apply finishing touches. When arpeggiator settings (6.1: Ed-Arp.) and controller settings (2.2: Ed-Ctrl) are added to this, the final result is called a “**program**.”

note Programs that are used in Combination mode or Sequencer mode have insert effect, master effect, master EQ, arpeggiator, and controller settings that are separate from those of Program mode.

The Compare function

As you are editing a program, you can use the [COMPARE] key to listen to the previously saved version of the sound, (as it was before you began editing). Press the [COMPARE] key (the key light comes on) to hear the original version. Pressing [COMPARE] again (the light goes dark) returns you to the version you are editing.

▲ If you edit while the [COMPARE] key is lit, the key will go dark. That sound will be the sound that is recalled when the [COMPARE] key is dark.

Oscillator settings 2.1: Ed-Basic

In 2.1: Ed-Basic you can make oscillator-related settings. This instrument provides two oscillators, and for each oscillator you can select a basic waveform (“**multisample**”) and set the pitch. The multisamples provided by this instrument include waveforms for musical instruments such as pianos, as well as special waveforms unique to synthesizers. Multisamples reproduce the complex overtone structure and frequency characteristics that allow us to identify a sound as being “piano-like” or “guitar-like.”

Basic (Prog Basic) page

PROG 2.1:Ed-Basic Prog Basic:Oscillator Mode	
Oscillator	Mode: Double
Voice Assign	Mode: Poly <input type="checkbox"/> Single Trigger
	<input type="checkbox"/> Hold <input checked="" type="checkbox"/> Legato Priority: Last
Scale	Type: Equal Temperament Key: C Random: 0
Basic	<input type="checkbox"/> OSC1 <input type="checkbox"/> OSC2 <input type="checkbox"/> U.Zone <input type="checkbox"/> Audit <input type="checkbox"/> UTILITY

Mode (Oscillator Mode)

This sets the mode of the oscillator.

Single uses one oscillator and **Double** uses two oscillators. In the case of **Single** the maximum polyphony is **62 notes**, and in the case of **Double** the maximum polyphony is **31 notes**. If you wish to use a Drum Kit to create a drums program, select **Drums**. (p.50)

Mode (Voice Assign Mode)

Indicates whether the program will sound in **Poly** (polyphonically) or **Mono** (monophonically). If this is set to **Poly**, you will be able to play chords using the program. If this is set to **Mono**, only one note will sound even if you play a chord. Normally you will set this to **Poly**, but it is effective to use **Mono** when you are playing sounds such as analog-synth bass or synth lead. Try switching between **Poly** and **Mono**, and listen to the result.

OSC1 page, OSC2 page

PROG 2.1:Ed-Basic OSC1:High Multisample	
OSC1 Multisample	Velocity SW L→H: 001
High ROM 200: Detuned-Super	[Octave: -1 [16°]
□ S.0fs □ Rev Level: 127	Transpose: +00
Low ROM 000: A.Piano	Tune: +0010
□ S.0fs □ Rev Level: 127	Delay: 0000ms
Basic	<input type="checkbox"/> OSC1 <input type="checkbox"/> OSC2 <input type="checkbox"/> U.Zone <input type="checkbox"/> Audit <input type="checkbox"/> UTILITY

Specifies the multisample for oscillator 1, 2.

Selecting a multisample

The multisample will determine the basic character of the program.

- Use “**High MS Bank**” to select the multisample bank, and use “**High Multisample**” to select the multisample.

If the “**High MS Bank**” is ROM, you can select preset multisamples. “**High Multisample**” can be selected from a range of 000–424. (p.VNL)

If “**High MS Bank**” is RAM, you can select multisamples that were created in Sampling mode or loaded in Media mode (if the EXB-SMPL option and sample data RAM is installed). In “**High Multisample**” you can select from 000–999.

note You can use the Utility “Select by Category” to select internal ROM multisamples from 15 categories. (p.PG p.7)

High Multisample and Low Multisample

If you specify a High and Low multisample for an oscillator, either the High or the Low multisample will sound depending on the velocity of the note (i.e., the strength at which you play the keyboard). This function is called **velocity multisample switching**.

- ① Specify different multisamples for “**High Multisample**” and “**Low Multisample**.”
- ② Specify a velocity value for “**Velocity SW L→H**.”

Notes played on the keyboard at a velocity less than the value you specify will sound the **Low** multisample; velocities at or above this velocity value will sound the **High** multisample.

For example if you set “**Velocity SW L→H**” to 100, playing the keyboard softly will sound the “Low” multisample, and playing strongly will sound the “High” multisample.

- ③ **Adjust the “Level” for High and Low multisamples to set their volume balance.**

⚡ If you do not wish to use this function, set the “**Velocity SW L → H**” value to 001. Only the High multisample will sound.

Rev (Reverse) check box

If this is **checked**, the multisample will be played backward. This can produce interesting results when used on sound-effects, etc. Normally you will not **check** this.

When “Oscillator Mode” = Double

To use OSC2, set “**Mode (Oscillator Mode)**” to **Double** in the Basic (Prog Basic) page. In the same way as for OSC1, you can set High and Low multisamples for OSC2.

The playback pitch can be set independently. By using the same multisample with slightly different “**Tune**” settings, you can “detune” the oscillators to produce a richer sound.

note It will be convenient to use the Utility “Copy Oscillator” to make the oscillator settings match each other.

When “Oscillator Mode” = Drums



In the Basic (Prog Basic) page, set “**Mode (Oscillator Mode)**” to **Drums**. When this is set to **Drums**, you will be able to create a drum program. This will select a **drum kit** instead of a multisample. This instrument provides sixteen factory preset drum kits that are suitable for a wide variety of music. (≡Drumkit name, VNL)
Here you can only select a drum kit. To edit or create a drum kit, use GLOBAL 5.1: DKit (≡p.94).

The following multisamples or drum kits can be used for the oscillator.

- 425 internal multisamples (ROM)
- Multisamples (RAM) created in Sampling mode (if the EXB-SMPL option is installed)
(You can create programs using multisamples/samples that were sampled in Sampling mode or loaded in Media mode.)
- Nine internal drum kits (ROM)

- 24 user drum kits created in Global mode
(Drum samples can be freely assigned to each key to create a drum kit. For the sound of each key, you can make filter and amp settings, and specify routing to the effects and to the individual audio outputs.)

V.Zone (Velocity Zone) page

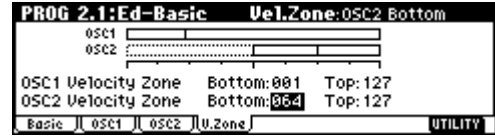

Here you can specify the range of velocities that will sound oscillators 1 and 2. In the example shown above, the velocity ranges are as follows.

- OSC1 will sound for all velocity values.
- OSC2 will sound only for strongly played notes (64 and above).
- You can use Velocity Multisample Switching in addition to this (≡“High Multisample, Low Multisample”). For this example, set “**OSC1**” in “**Velocity SW L→H**” to 32 and “**OSC2**” to 96. The settings are shown as vertical lines in the velocity zone display.

In this example, the multisamples will sound over four levels.

Velocity values 001–031:
sound only the OSC1 Low multisample.

Velocity values 032–063:
sound only the OSC1 High multisample.

Velocity values 064–095:
sound the OSC1 High multisample and the OSC2 Low multisample.

Velocity values 096–127:
sound the OSC1 High multisample and the OSC2 High multisample.

Controller settings 2.2: Ed-Ctrl

Ctrl (Controls) page

For each program, this tab lets you make settings for the [SW1] and [SW2,] and for the B-mode of REAL-TIME CONTROLS knobs [1]–[4] (≡p.115, PG p.9, 220, 221)

Pitch settings 3.1: Ed-Pitch

Here you can specify how the pitch of the multisample selected for the oscillator will change. Pitch EG and LFO settings allow the pitch to varied over time.

The parameters of the OSC2 page and OSC2lfo page are valid only if “**Mode (Oscillator Mode)**” is set to **Double**.

OSC1 page

PROG 3.1:Ed-Pitch		OSC1:Pitch Slope	
Pitch	Pitch Slope: +1.0	JS(+X): +02	AMS: Off
	Ribbon(#16): +00	JS(-X): -02	Intensity: +00.00
Pitch EG	Intensity: +00.00	AMS: Off	Intensity: +00.00
Portamento	<input type="checkbox"/> Enable	<input type="checkbox"/> Fingered	Time: 000
osc1 0s11f0 0s2 0s21f0 EG			UTILITY

Pitch

The “JS (-X)” and “JS(+X)” settings specify the amount of pitch change (in semitones) that will occur when MIDI pitch bend messages are received or when the joystick is moved to left or right. A setting of +12 allows the pitch to be controlled a maximum of one octave upward; a setting of -12 allows the pitch to be controlled a maximum of one octave downward.

“Ribbon (#16)” specifies the amount of pitch change (in semitones) that will occur when MIDI control change (CC) #16 messages are received or when the ribbon controller of a TRITON or other MIDI-connected instrument is moved to left or right. With a setting of +12, the pitch will rise one octave at the far right of the ribbon controller, and fall one octave downward at the far left of the ribbon controller.

Pitch EG

When the “Intensity” value is set to +12.00, the pitch EG specified in the Pitch EG page will produce a maximum of ±1 octave of pitch change.

Portamento

If “Enable” is checked, portamento will be applied. Portamento makes the pitch change smoothly when you play the next note before releasing the previous note.

The “Time” parameter specifies the portamento time. As this value is increased, the pitch will change over a longer time. With a value of 000, there will be no portamento.

▲ If Porta.SW (CC#65) is assigned as the function of [SW1] or [SW2] key, the portamento effect can be switched on/off by [SW1] or [SW2] key.

OS1lfo (OSC1 LFO) page

PROG 3.1:Ed-Pitch		OSC1 LFO:LFO1 Intensity	
Pitch LFO1/2 Modulation			
LFO1	Intensity: +00.00	AMS: AfterT	Intensity: +00.25
	JS+Y Int.: +01.00		
LFO2	Intensity: +00.00	AMS: Off	Intensity: +00.00
	JS+Y Int.: +00.00		
osc1 0s11f0 0s2 0s21f0 EG			UTILITY

LFO 1/2

An LFO can be used to cyclically modulate the pitch (the “vibrato” effect).

“Intensity (LFO Intensity)” sets the depth to which the LFO specified in 5.3: Ed-LFOs will affect the pitch. With a setting of +12.00, vibrato will produce a maximum of ±1 octave of pitch change.

“JS+Y Int” specifies the amount of vibrato that the LFO will produce when the joystick is pushed away from yourself.

“Intensity (AMS Intensity)” specifies the depth of vibrato that will be applied by the LFO when AMS (Alternate Modulation Source) is operated. For example if “AMS (LFO1 AMS)” is set to AfterT and you set an appropriate value for “Intensity (AMS Intensity),” vibrato will be applied when you apply pressure to the keyboard or when MIDI aftertouch messages are received.

EG (Pitch EG) page

Here you can make settings for the pitch EG.

When you wish to create sound effects etc., set the pitch EG to make major changes in pitch over time. To realistically simulate the slight change in pitch that occurs when a string is plucked or at the attack of a brass or vocal sound, you can use the EG to create a subtle change in pitch at the attack (PG p.10).

EG and LFO

By using an EG (envelope generator) to apply time-varying change or by using an LFO (Low Frequency Oscillator) to apply cyclic change to pitch, filter, or amp, you can create changes in the pitch, tone, or volume.

EG (Envelope Generator)

This instrument provides a Pitch EG, Filter EG, and Amplifier EG, which produce time-varying changes in pitch, tone, and volume respectively.

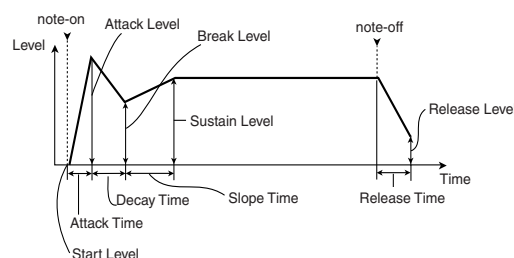

LFO (Low Frequency Oscillator)

For each oscillator, this instrument provides two LFO's that can be used to apply cyclical change in pitch, tone, and volume.

Examples of this are vibrato (cyclical change in pitch), wah (cyclical change in tone), and tremolo or auto-pan (cyclical change in volume).

Filter settings

4.1: Ed-Filter1, 4.2: Ed-Filter2

The filter allows you to diminish or emphasize specified frequency areas of the multisample selected for the oscillator. The tone of the sound will depend significantly on the filter settings.

This instrument provides Filter 1 for OSC1 and Filter 2 for OSC2. For each of these filters, you can select from two types (Low Pass Resonance or Low Pass & High Pass). Filter 2 can be used if “Mode (Oscillator Mode)” is set to Double.

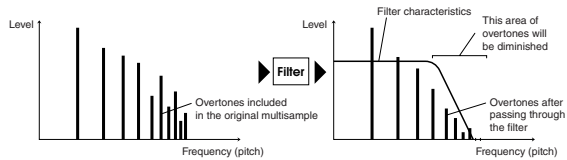

Basic page

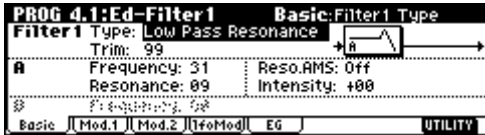

Filter Type, Filter A, Filter B

Selects the type of filter, and specify the “Frequency” (cutoff frequency) and “Resonance” (resonance level).

- **Low Pass Resonance** (24 dB/oct low pass filter with resonance): Make settings for filter A.
- **Low Pass & High Pass** (12 dB/oct low pass filter and 12 dB/oct high pass filter in series connection): Make low pass filter settings in filter A, and high pass filter settings in filter B.

Low pass filter

This is the most common type of filter, which passes the low frequency range and cuts the high frequency range. When the overtones of the high range are cut, a bright sound will become darker (more mellow). 24 dB/oct and 12 dB/oct refer to the steepness of the cut. 24 dB/oct means that the gain will decrease 24 dB in one octave (i.e., as the frequency doubles). A 12 dB/oct filter would decrease the gain 12 dB in one octave. The 24 dB/oct filter produces a steeper cut.

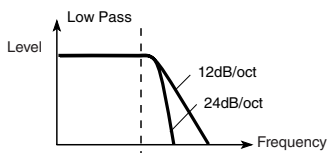

High pass filter

This type of filter passes the high frequency range and cuts the low frequency range. Use this when you wish to make the sound thinner. However if the cutoff frequency (Frequency) is raised excessively high, the volume will become very low.

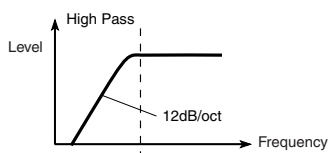

Resonance

When “Resonance” is set to a higher value, the overtones in the region of the cutoff frequency will be boosted as shown in the diagram below, giving a distinctive character to the sound.

When resonance is applied

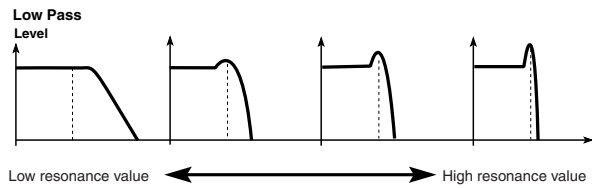

Mod.1, Mod.2 page

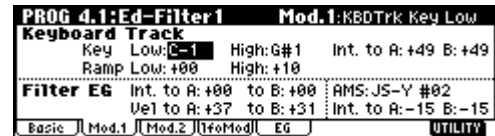

Controllers and the filter EG can be used to modulate the filter cutoff frequency that was specified in the Basic page. By using a controller to vary the tone or by using an EG to create time-varying changes, you can add a rich variety of tonal change to the sound.

Keyboard Track (Mod.1 page)

This varies the cutoff frequency according to the position of the key on the keyboard that you play.

- When Ramp “Low” is set to a positive (+) value, the cutoff frequency will rise as you play lower on the keyboard, making the sound brighter. When set to a negative (–) value, the cutoff frequency will fall as you play lower on the keyboard, making the sound darker.
- When Ramp “High” is set to a positive (+) value, the cutoff frequency will rise as you play higher on the keyboard, making the sound brighter. When set to a negative (–) value, the cutoff frequency will fall as you play higher on the keyboard, making the sound darker.
- Int. “to A” and “to B” adjust the effect that keyboard tracking will have on filters A and B (PG p.14).

Filter EG (Mod.1 page)

Adjusts the effect produced by the filter EG, whose settings are made in the EG page.

- Use the Int. “to A” and “to B” settings to specify the depth of the filter EG.
- Use the Vel “to A” and “to B” settings to specify the effect of velocity on the filter EG.
- “AMS” and “Int to A, B” adjust the effect that AMS will have on the filter EG depth.

These three settings will determine the depth of the tonal change produced by the filter EG.

Filter Modulation (Mod.2 page)

Set this when you wish to produce tonal change by using controllers etc. to vary the cutoff frequency.

lfoMod (LFO Mod.) page

Indicates settings that allow the LFO to produce cyclic changes in tone (a “wah” effect).

Intensity: “to A (LFO1 Int. to A)” and “to B (LFO1 Int. to B)” specify by how much the LFO will change the tone. **JS-Y Int.:** “to A” and “to B” specify the depth of the wah effect that will be produced by the LFO when the joystick of this instrument is moved toward yourself, or when CC#2 is received.

“**Int. to A**” and “**Int. to B**” specify the depth of the wah effect that will be produced by the LFO when “**AMS**” (Alternate Modulation Source) is operated. For example if “**AMS**” is set to **AfterT**, applying pressure to the keyboard of the TRITON Le, will apply a wah effect.

EG page

Indicates settings for the filter EG, which controls time-variant changes in tone (PG p.16). Make settings for the EG here, and set the depth of its effect in the Mod.1 page “Filter EG” parameter.

Filter EG and Amplifier EG

When the Filter EG changes the cutoff frequency, the tone will change. However depending on the volume changes produced by the Amplifier EG, this can be heard in different ways. For example by changing the speed at which the tone and volume begin (attack) or decay, you can significantly vary the character of the tonal change. It is a good idea to adjust the changes of both the Filter EG (tone) and the Amplifier EG (volume) as you proceed with editing. (5.1: Ed-Amp1, EG page, 5.2: Ed-Amp2, EG page)

Amplifier settings

5.1: Ed-Amp1, 5.2: Ed-Amp2

These settings affect the volume. Here you can adjust the way in which the Amp EG and LFO produce time-varying and cyclic changes in volume, and how the controllers etc. will affect the volume.

Amp1 applies to OSC1, and Amp2 applies to OSC2. Amp2 can be used if “**Mode (Oscillator Mode)**” is set to **Double**.

For example, the volume of a piano note begins at a high volume the instant you play the note, and then decreases gradually. The volume of an organ note remains constant as long as you continue pressing the key. The volume of a note on a violin or wind instrument can be varied during the note by the musician (i.e., by regulating the amount of pressure on the bow or the force of the breath).

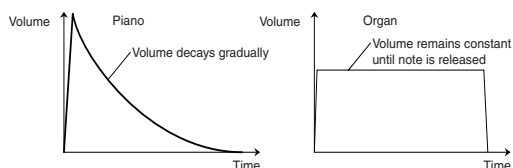

Lvl/Pan (Level/Pan) page

PRG 5.1:Ed-Amp1		Level/Pan: Amp1 Level	
Amp1	Level: 127		
Pan	Pan: C064	AMS: Note No.	
	<input type="checkbox"/> Use DKit Setting	Intensity: +00	
Lvl/Pan	Mod.	EG	UTILITY

Amp1 Level, Amp2 Level

Adjusts the volume of the sound that has passed through the oscillator, filter, and amp.

Pan

Specifies the pan (stereo position) after the signal has passed through the oscillator, filter, and amp. Normally you will set this to **C064**. If “**Mode (Oscillator Mode)**” is **Double** and you wish to create a sense of stereo, set the 5.1: Ed-Amp1 and 5.2: Ed-Amp2 parameter “**Pan**” to left and right for oscillators 1 and 2 respectively. With a setting of **Random**, the pan will change randomly each time you play a note on this instrument, producing an interesting effect.

AMS Intensity

“**Intensity**” specifies the depth of the panning effect that will occur when “**AMS**” is operated.

If you set “**AMS**” to **Note No.**, the pan will change according to the keyboard position at which you play a note on a this instrument. With a setting of **LFO1** or **2**, the pan will sweep from side to side (auto pan). Other settings allow you to move the oscillator pan by operating a controller.

Use DKit Setting

This is valid when “**Mode (Oscillator Mode)**” is set to **Drums**. If this is **checked**, the pan location specified by the Drum Kit for each drum sound will be used. If this is **unchecked**, all drum sounds will sound at the same location. Preload and GM drum kits are set to stereo settings. Normally you will leave this **checked**.

Mod. page

PRG 5.1:Ed-Amp1		Mod.: KBDTrk Key Low	
Keyboard Track			
	Key Low: F#4	High: F#4	
	Ramp Low: +04	High: +00	
Amp Mod.	Velocity Int: +50	AMS: AfterT	Int: +00
LF01 Mod.	Intensity: +00	AMS: Off	Int: +00
LF02 Mod.	Intensity: +00	AMS: Off	Int: +00
Lvl/Pan	Mod.	EG	UTILITY

Keyboard Track

This lets you vary the volume relative to the position of the key you are playing on the keyboard.

- When Ramp “**Low**” has a positive (+) value, the volume will increase as you play lower on the keyboard. With a negative (–) value, the volume will decrease as you play lower on the keyboard.
- When Ramp “**High**” has a positive (+) value, the volume will increase as you play higher on the keyboard. With a negative (–) value, the volume will decrease as you play higher on the keyboard.

Amp Mod.

“Velocity Int” is used by most programs to decrease the volume of softly played notes and increase the volume of strongly played notes, and this Amp Modulation parameter adjusts the depth of this control. Normally you will set Amp Modulation to positive (+) values. As this setting is increased, there will be greater volume difference between softly played and strongly played notes.

LFO1 Mod., LFO2 Mod.

Specify how the LFO’s will produce cyclic changes in volume (the tremolo effect).

The volume will be affected by the LFO(s) for which you set an “Intensity (LFO1 Intensity, LFO2 Intensity)” value.

“Int (AMS Intensity)” adjusts the depth by which the tremolo effect produced by the LFO will be affected when you operate an “AMS (LFO1 AMS, LFO2 AMS).”

For example if you set “AMS” to JS-Y #02, tremolo will be applied when you move the joystick of this instrument. toward yourself, or when CC#02 is received.

EG page

Here you can make settings for the amp EG, which changes the volume over time.

Every instrument has its own characteristic curve of volume change. This is part of what gives each instrument its identifiable character. Conversely, by applying a strings-type Amp EG curve to an organ-type multi-sample, you can produce a sound with a character unlike a typical organ.

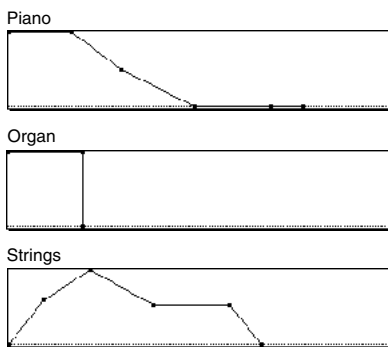

LFO settings 5.3: Ed-LFOs

For each oscillator, you can use two LFO (Low Frequency Oscillator) units: LFO1 and LFO2. You are free to select the type of each LFO and set its speed. The depth of the LFO1 and LFO2 that you specify here is adjusted by the settings of the 3.1: Ed-Pitch, 4.1: Ed-Filter1, 4.2: Ed-Filter2, 5.1: Ed-Amp1, and 5.2: Ed-Amp2 pages.

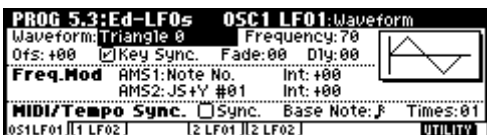

OSC1 LFO1, OSC1 LFO2, OSC2 LFO1, OSC2 LFO2

“Waveform” selects the type of LFO. You can choose from a variety of waveforms, including standard waveforms such as Triangle, Saw, Square, and Sine, as well as Step or Random PG waveforms that produce a sample-and-hold effect (ESP PG p.22). You can create a wide variety of effects by adjusting the “Ofc,” “Fade,” and “Dly” settings, and by changing the sign (+/-) of the “Intensity” setting in the 3.1: Ed-Pitch, 4.1: Ed-Filter1, 4.2: Ed-Filter2, 5.1: Ed-Amp1, and 5.2: Ed-Amp2 pages. “Frequency” specifies the speed of the LFO.

Freq.Mod (Frequency Modulation)

“AMS” can be used to vary the LFO speed. This lets you change the LFO speed by operating a controller, or by the EG or Keyboard Track settings.

MIDI/Tempo Sync.

If “MIDI/Tempo Sync” is checked, the “Frequency” setting will be ignored, and the LFO will synchronize to the tempo of the sequencer and arpeggiator. This lets you produce vibrato, wah, auto-pan, or tremolo that is synchronized to the playback speed of the sequencer or arpeggiator.

Arpeggiator settings 6.1: Ed-Arp.

Here you can make arpeggiator settings (ESP p.99).

BUS settings 7.1: Ed-InsertFX BUS

You can specify the oscillator routing (the signal sent to the insert effect, master effects, and independent outputs) (ESP p.108).

Insert Effect settings 7.1: Ed-InsertFX Setup, IFX

Here you can select insert effect and make settings for them (ESP p.109).

Master Effect settings 7.2: Ed-MasterFX

Here you can select master effects and make settings for them. The master EQ is also set here (ESP p.109).

More about Alternate Modulation

Alternate Modulation is a type of modulation that can be used to control various aspects of the sound.

AMS (Alternate Modulation Source) refers to any of the numerous sources that can control alternate modulation, and includes controllers that you operate physically such as the joystick and realtime controllers, incoming MIDI data, as well as modulators such as the EG or LFO.

Since this instrument allows you apply modulation to a modulator, this type of control is referred to as “alternate modulation.”

Intensity is a parameter that sets the degree (speed or depth) to which AMS will control alternate modulation.

Combinations of modulations that are frequently used in on the synthesizer performance (such as using the joystick to vary the pitch) are also provided as special parameters separately from alternate modulation.

This instrument provides 29 types of alternate modulation.

In single mode you can use 29 alternate modulation destinations of 29 types, and in double mode you can use 55 alternate modulation destinations of 29 types. There are 42 AMS sources. (However depending on the type of modulation, some sources cannot be selected.) For details on alternate modulation and AMS, refer to PG p.211.

Suggestions on using alternate modulation

When making settings for alternate modulation, think of the effect that you wish to produce, what type of modulation will be necessary to produce that effect, and what parameter of the oscillator, filter, or amplifier needs to be controlled. Then select a source (“**AMS**”) and set the “**Intensity**.” If you proceed logically in this way, you will achieve the desired effect.

For example if you want to “control a guitar-like sound so that it appears to be approaching feedback when the joystick is moved away,” you will make settings so that the joystick controls filter modulation or the resonance level.

Combination mode

In Combination mode you select, play and edit combinations.

Combination mode consists of pages 1.1: Play–7.2: Ed-MasterFX.

In 1.1: Play; you can select and play combinations. You can also do some overall editing, and make arpeggiator settings (see p.28, 32).

In 2.1: Ed-Basic–7.2: Ed-MasterFX; you can edit the parameters of the combination that was selected in 1.1: Play.

How a combination is organized

A combination consists of a variety of parameters that can be accessed in 2.1: Ed-Basic–7.2: Ed-MasterFX. The diagram below shows how a combination is structured.

Basic combination editing

Banks A, B, and C of the TRITON Le contain a variety of combinations that use the preloaded programs (banks A, B, C) and the preset and preloaded user arpeggio patterns and effects. You can edit these combinations to create your own original combinations.

Original programs using samples/multisamples recorded in Sampling mode (if the separately sold EXB-SMPL option is installed) or loaded into memory in Media mode can also be used in a combination. Combinations you edit or create can be written into the 384 combination memory areas of banks A–C. They can also be saved and managed on SmartMedia in Media mode (see p.42, 45).

note If a program being edited in Program mode is used in a combination, it will sound according to the settings being edited.

note If you wish to save an edited combination in internal memory, you must write it. (see p.42)

Suggestions for editing procedure

The parameters of each timbre are set in 2.1: Ed-Prog/Mix–4.4: MIDI Filter4, and 7.1:Ed-InsertFX. This is where you create the basic combination consisting of the programs you select here.

First use 2.1: Ed-Prog/Mix to select the program for each timbre, and then use 3.3: Ed-Key Zone and 3.4: Ed-Vel Zone to specify the range in which each program will sound (layer, split, velocity switch, etc.). Then adjust the volume of each timbre, and set various other parameters.

To add finishing touches to the sound, you can make **insert effect** settings (in 7.1: Ed-InsertFX) and **master effect** and **master EQ** settings (in 7.2: Ed-MasterFX) that are separate from the effect settings of Program mode. In addition, you can make arpeggiator settings (in 6.1: Ed-Arp.) and controller settings (in 2.2: Ed-Ctrl) to create the finished **combination**.

note By using the Utility “Solo Selected Timbre”, you can listen only to the selected timbre. This is a convenient way to audition individual sounds of timbres that are layered. (see p.33)

note In pages that display all timbres 1–8, such as 2.1: Ed-Prog/Mix, you can use the [◀], [▶] keys to select timbres. You can also select timbres directly by holding down the [TIMBRE/TRACK] key and pressing one of the [F1 T1/T9]–[F8 T8/T16] keys.

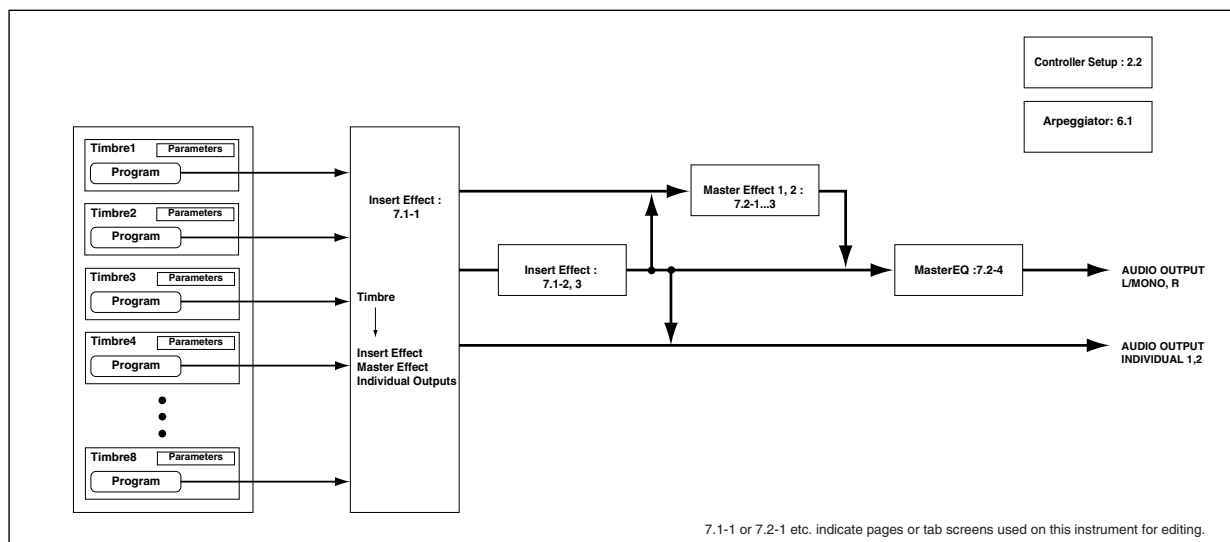

Layer, split, and velocity switch

Within a combination, you can use keyboard location and velocity to change the program that sounds. The programs assigned to each timbre can sound in three ways: as a **layer**, a **split**, or a **velocity switch**. A combination can be set to use any one of these methods, or to use two or more of these methods.

Layer

Layer refers to settings which cause two or more programs to sound simultaneously when a note is played.

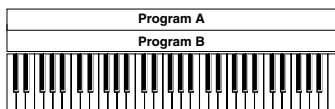

Layer:
Two or more programs sound simultaneously.

Split

Split refers to settings which cause different programs to sound on different areas of the keyboard.

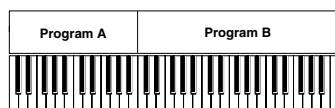

Split:
Different programs will sound in different areas of the keyboard.

Velocity switch

Velocity Switch refers to settings which cause different programs to sound depending on the velocity (keyboard playing dynamics).

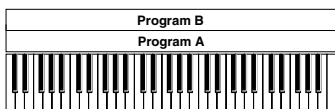

Strong ↑ Keyboard playing dynamics
Soft ↓
Velocity Switch:
Keyboard playing dynamics (velocity) switches between different programs.

On this instrument, you can use a different program for each of up to eight timbres, and combine two or more of the above methods to create even more complex setups.

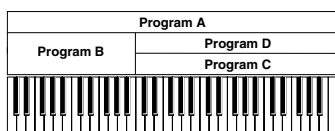

Strong ↑ Keyboard playing dynamics
Soft ↓
Example:
B and C, D are split. In the lower keyboard range, A and B are layered. In the higher keyboard range, C and D are switched by velocity and layered with A.

As an additional possibility, you can set the slope for a key zone or velocity zone so that the volume diminishes gradually. This lets you change a split into a **keyboard crossfade**, or a velocity switch into a **velocity crossfade**.

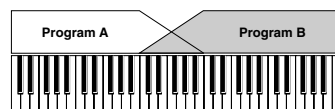

Keyboard X-Fade
(keyboard crossfade):
As you play from low notes to high notes, the volume of A will fade out, and the volume of B will fade in.

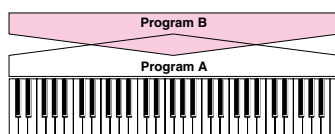

Strong ↑ Keyboard playing dynamics
Soft ↓
Velocity X-Fade
(velocity crossfade):
As you play with increasingly stronger velocity, the volume of A will fade out, and the volume of B will fade in.

The Compare function

As you are editing a combi, you can use the [COMPARE] key to listen to the previously saved version (as it was before you began editing). Press the [COMPARE] key (the key light comes on) to hear the original version. Pressing [COMPARE] again (the light goes dark) returns you to the version you are editing.

🔊 If you continue editing when the [COMPARE] key LED is lit, the LED will go dark, and the current sound will now be the sound that is recalled when the [COMPARE] key LED is dark.

In the section below, we will edit typical parameters in each page while listening to the effect of each parameter.

For a more detailed explanation of these parameters, refer to PG p.31–.

Timbre 1–8 program, pan and volume

2.1: Ed-Prog/Mix

Here you can assign programs to each timbre 1–8, and set pan and volume for each. (These settings can also be made in the Prog and Mix pages of 1.1: Play.)

Prog page

COMBI 2.1:Ed-Prog/Mix								Prog:Program Select	
1	2	3	4	5	6	7	8	9	10
Keyb	Keyb	Keyb	Strin	Strin	Fast	Keyb	Drum		
A113	A113	B001	C067	C067	A000	A001	A100		
Romance	Romance	White Piano	Analog	Analog	Big Swe	Acoustic	Tricks		
T01: A113:Romance Piano								Ch:Gch	
Prog								MIX	
								UTILITY	

Program Select

Assigns a program to each timbre.

📝 You can use the Utility menu command “Select by Category” to select programs from 16 categories. (p.32)

📝 You can also use the [BANK] and [A]–[GM] keys to select the bank of the program.

🔊 If you wish to select programs by receiving MIDI program changes, do so in P1.1: Play.

Mix (Mixer) page

COMBI 2.1:Ed-Prog/Mix								Mixer:Volume	
1	2	3	4	5	6	7	8	9	10
Keyb	Keyb	Keyb	Strin	Strin	Fast	Keyb	Drum		
C064	C064	C064	L025	R100	C064	C064	C064		
103	127	091	077	077	127	127	101		
T01: A113:Romance Piano								Ch:Gch	
Prog								MIX	
								UTILITY	

Pan

Specifies the panning (stereo location) for each timbre. A setting of C064 will reproduce the oscillator pan setting of the program. Moving this to left or right will move the sound to left or right while preserving the pan relationship between the oscillators. A setting of L001 is far left, and R127 is far right.

Volume

Adjusts the volume of each timbre. Create the overall sound by adjusting the volume balance between timbres. The “Volume” setting is an important aspect of creating the sound, and this setting will have a significant effect on the overall impression produced by the Combination.

Controller settings 2.2: Ed-Ctrl

Ctrls (Controls) page

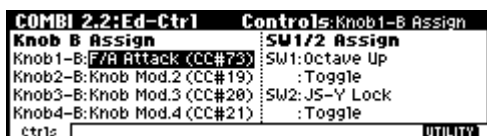

For each combination, you can specify the functions of the B-mode functions of REALTIME CONTROLS knobs [1]–[4], and the [SW1] and [SW2.] (see p.115, PG p.36, 220, 221)

Settings for status, MIDI channel, and playing mode 3.1: Ed-Param 1

MIDI page



Status

Here you can specify the state of MIDI and the internal tone generator for each timbre. Normally when sounding the internal tone generator of this instrument, you will set this to **INT**. Set this to **Off** for timbres that you are not using. With settings of **Off**, **EXT**, or **EX2**, this instrument will not sound. With settings of **EXT** or **EX2**, you can control an external tone generator connected via MIDI. (see PG p.36)

MIDI Channel

Timbres that you wish to play from this instrument’s keyboard must be set to the global MIDI channel. Your playing on the keyboard is transmitted on the global MIDI channel, and will sound any timbre that matches this channel. Normally you will set this to **Gch**. When this is set to **Gch**, the MIDI channel of the timbre will always match the global MIDI channel, even if you change the global MIDI channel.

On some preloaded combinations that use the arpeggiator, timbres assigned to the arpeggiator may not have a “Status” of **INT** and “MIDI Ch” of **Gch**.

The reason for this is that these settings are for timbres that sound only when the arpeggiator is on. This is a very useful technique for creating combinations that use the arpeggiator. Refer to “Arpeg-

giator settings in Combination and Sequencer modes” (see p.101, PG p.43), and study the relationship between arpeggiator assignments, “Status,” and “MIDI Channel.”

Bank(EX2) MSB, Bank(EX2) LSB

This setting is valid when “Status” is set to **EX2**. It specifies the Bank Select message that will be transmitted from this instrument.

OSC page



Force OSC Mode

Normally you will set this to **PRG**. If you wish to force a polyphonic program to sound monophonically, set this either to **Mono** or **LGT (Legato)**. Conversely, set this to **Poly** if you wish to force a monophonic program to play polyphonically (see PG p.37).

OSC Select

Normally you will set this to **Both**. If the timbre is using a program whose “Mode (Oscillator Mode)” is **Double**, and you want only **OSC1** or **OSC2** (not both) to sound, set this to **OSC1** (only **OSC1** will sound) or **OSC2** (only **OSC2** will sound).

Portamento

Normally you will set this to **PRG**. If you want the portamento setting specified for the program of the timbre to be forced off, set this parameter to **Off**. Conversely, if you want to forcibly turn the portamento on, or to change the portamento time, set this to a value of **001–127** to specify the portamento time.

Pitch page

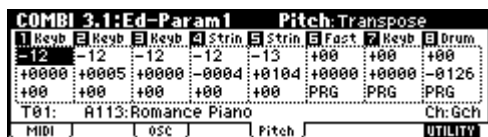

Transpose, Detune (BPM Adjust)

These parameters adjust the pitch of the timbre.

- In a layer-type combination, you can set two or more timbres to the same program, and create a richer sound by using “Transpose” to shift their pitch apart by an octave or by using “Detune” to create a slight difference in pitch between the two.
- In split-type combinations, you can use “Transpose” to shift the pitch (in semitone units) of the programs specified for each key zone.
- If you wish to change the playback pitch of a drum program, use “Detune.” If you change the “Transpose” setting, the correspondence between notes and drum sounds will change.

Adjusting the BPM of multisamples or samples created in Sampling mode (requires the EXB-SMPL option be installed)

If a timbre program uses multisamples or samples that you created in Sampling mode (or loaded in Media mode) to a specific BPM value, you can use the Utility “Detune BPM Adjust” to call up a new specified BPM value. This changes the BPM by changing the playback pitch. (PG p.38)

Note timing and scale settings

3.2: Ed-Param2

Other page

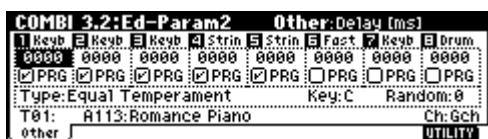

Delay [ms]

Specifies the timing at which the program of each timbre will sound. Specify the time from when you play the keyboard until the program will sound. If you select KeyOff for this parameter, the timbre will sound when the note is released.

Use Prog’s Scale, Combi’s Scale

Specifies the scale for each timbre. If you check “Use Prog’s Scale,” the scale specified by the program will be used. Timbres for which this is **not checked** will use the “Combi’s Scale” setting.

Layer and split settings

3.3: Ed-Key Zone

Indicates settings such as layer, split, and keyboard crossfade.

Key page

Specifies the range of notes that will sound each timbre. Each area that sounds a timbre is referred to as a **Key Zone**. By setting key zones, you can create a combination in which different programs sound in different areas of the keyboard.

By combining key zones specified for each timbre, you can create **layered** or **split** combinations.

The upper and lower limits for the key zone of each timbre are set by the “Top Key” and “Bottom Key” respectively.

For example in the following diagram, timbres 1–3 are set to create a layered and split combination. This is specified by the key zone settings.

Timbres 2 and 3 create a layer. Timbre 1 and timbres 2/3 are split between the B3 and C4 note numbers.

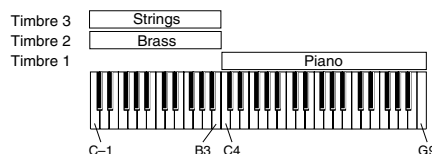

As an example here, we will explain how to create a combination like the one shown above.

- ① In the 1.1: Play, Prog page or the 2.1: Ed-Prog/Mix, Prog page, use the “Program Select” area to select the program that will be used for each timbre 1–3.

Select a piano program for timbre 1.
Select a brass program for timbre 2.
Select a strings program for timbre 3.

- ② In the MIDI page of 3.1: Ed-Param1, set “Status” to INT for all the timbres that you wish to use, and set “MIDI Channel” to either Gch or to match the global MIDI channel (a “G” will be displayed after the channel number).

- ③ In the Key page of 3.3: Edit-Key Zone, set “Top Key” and “Bottom Key.”

Set timbre 1 to a “Top Key” of G9 and a “Bottom Key” of C4.
Set timbres 2 and 3 to a “Top Key” of B3 and a “Bottom Key” of C–1.

note You can also enter these values by holding down the [ENTER] key and playing a note on the keyboard of this instrument.

Slope page

Here you can specify the range of keys over which the original volume will be reached, starting at the top key and bottom key.

In the case of the above example, you could set the key zones so that a portion of timbres 1 and 2 overlaps (i.e., is layered) with timbre 3, and set “Top Slope” and “Bottom Slope” so that the sound changes gradually, instead of changing suddenly between B3 and C4.

Velocity switch settings

3.4: Ed-Vel Zone

Here you can make settings for velocity switching and velocity crossfading.

Vel (Velocity) page

For each timbre, you can specify a range of velocities for which it will sound. The range of velocities for which a timbre will sound is called the **Velocity Zone**. By setting a velocity zone, you can set up a timbre which will be sounded only by notes played at a certain strength, and not by stronger or weaker notes. By combining timbres that have differing velocity zone settings, you can create **velocity switched** combinations.

The upper and lower limits of the velocity zone of each timbre are determined by the “**Top Velocity**” and “**Bottom Velocity**” respectively. The following diagram shows an example of a velocity switched combination in velocity will switch between timbres 1 and 2 to play different programs. Such combinations are created by setting the velocity zone.

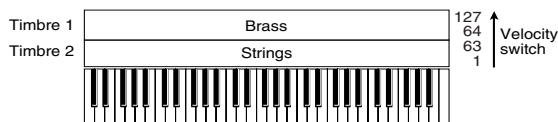

As an example, we will explain how to create a combination like the one shown above.

- 1 In the 1.1: Play, Prog page or the 2.1: Ed-Prog/Mix, Prog page, use the “Program Select” area to select the program that will be used for each timbre 1 and 2.

Select a brass program for timbre 1.
Select a strings program for timbre 2.

- 2 In the MIDI page of 3.1: Ed-Param1, set “Status” to INT for all the timbres that you wish to use, and set “MIDI Channel” to either Gch or to match the global MIDI channel (a “G” will be displayed after the channel number).

- 3 In 3.4: Ed-Vel Zone Vel page, set the “Top Velocity” and “Bottom Velocity.”

Set timbre 1 to a “Top Velocity” of 127 and a “Bottom Velocity” of 64.

Set timbre 2 to a “Top Velocity” of 63 and a “Bottom Velocity” of 1.

note You can also enter these values by holding down the [ENTER] key and playing a note on the keyboard of this instrument.

Slope page

Here you can specify the range of values over which the original volume will be reached, starting from the top velocity and bottom velocity.

In the case of the above example, you could set the velocity zones of the two timbres so that they partially overlap, and set “Top Slope” and “Bottom Slope” so that the sound changes gradually, instead of changing suddenly between velocity values of 63 and 64.

MIDI filter settings

4.1: Ed-MIDI Filter1–4.4: Ed-MIDI Filter4

For each MIDI Filter item, you can specify whether or not the corresponding MIDI message will be transmitted and received. The **checked** items will be transmitted and received.

▲ MIDI filter does not turn the function itself on/off, but specifies whether or not that MIDI message will be transmitted and received. For example if portamento is on, portamento will be applied to the sound of this instrument even if “Portamento SW CC#65” is unchecked.

For example if you selected a bass program for timbre 1 and a piano program for timbre 2 to create a split-type combination, you could make the following settings so that pressing the connected damper pedal would apply the damper effect only to the piano program of timbre 2.

- Set “Damper CC#64” in 4.1: Ed-MIDI Filter1, MIDI 1-2 page.

Timbre 1 “Damper CC#64”: unchecked

Timbre 2 “Damper CC#64”: checked



Arpeggiator settings

6.1: Ed-Arp.

Indicates settings for the arpeggiator (p.101).

Bus settings

7.1: Ed-InsertFX BUS

Specifies the routing for each timbre (i.e., how it is sent to the insert effect, master effects, and individual outputs). (p.110)

Insert Effect settings

7.1: Ed-InsertFX Setup, IFX

Indicates insert effect, and make settings for them. (p.110).

Master Effect settings

7.2: Ed-MasterFX

Indicates master effects, and make settings for them. Here you can also make master EQ settings (p.110).

Sequencer mode

This instrument contains a 16-multi track MIDI sequencer. The sequencer is the center to which TRITON Le's numerous functions are integrated, allowing it to be used in a variety of situations including music production and live performance.

 When you turn off the power, the settings made in Sequencer mode and the song data, cue list data, and user pattern data that you recorded are not backed up. If you wish to keep this data, you must save it on external media (SmartMedia etc.) before turning off the power, or perform a MIDI data dump to save the data on an external data filer etc.

If you wish to save the programs, track parameters, effects, and arpeggiator function settings etc. selected for a song as a template song, use the Utility menu command "Save Template Song."

Immediately after the power is turned on, this instrument will not contain any cue list data or song data, so if you wish to playback a song on the sequencer, you must first load data from external media (SmartMedia etc.) or receive a MIDI data dump from an external MIDI sequencer (see p.41, 97, PG p.143)

Features of the sequencer

- The sequencer lets you record a **maximum of 200,000 events** (note data etc.), up to **200 songs**, and as many as **999 measures** per song.
- Up to **20 cue lists** can be created. A cue list is an arrangement of up to 99 songs that will be played as a chain. You can specify the number of times that each song will repeat. Songs in a cue list can also be converted into a single song.
- The **arpeggiator function** can be used for playback or recording.
- The **RPPR (Realtime Pattern Play/Recording) function** can be used for playback or recording.
- **Sixteen different template songs** are built-in, and contain program and effect settings suitable for various musical styles. Up to sixteen original templates that you create can be saved as user template songs.
- **One stereo insertion effect, two master effects, and a stereo master EQ** can be used for each song.
- Timing resolution is a maximum of $\frac{1}{192}$.
- **Sixteen tracks** are provided for musical data, and a **master track** contains time signature and tempo data that controls the playback.
- A **track play loop function** lets you loop specified measures independently for each track.
- **150 preset patterns** ideal for drum tracks are built in. In addition, you can **create up to 100 user patterns** for each song. These patterns can be used as musical data within a song, or can be played by the RPPR function.

- Various methods of recording are supported, including **realtime recording** in which your performance on the keyboard and controllers (including MIDI control events) is recorded just as you play, and **step recording** in which the timing, length, and velocity of each note can be specify in the LCD as you input the pitches from the keyboard.
- The musical data and control events that you recorded can be edited in various ways (including **event editing** and many other edit commands).
- When the "Status" of a track is set to **INT** or **BTH**, an external sequencer can be used to play this instrument as a **multi-timbral tone** generator. When the "Status" of a track is set to **BTH**, **EXT**, or **EXT2**, the sequencer of this instrument can **play external tone** generators.
- Playback can be **synchronized with an external MIDI device**.
- This instrument's **AMS (Alternate Modulation)** capability lets you use control changes for realtime control of the parameters of the programs used in a program. Its **MIDI Sync. functionality** lets you synchronize the LFO speed to changes in the tempo.
- **Dmod (Dynamic Modulation) functionality** lets you control effect parameters in realtime. You can also use **MIDI Sync.** to synchronize the LFO speed or delay time to changes in the tempo.
- You can assign names not only to the song, but also to each pattern and track.
- Combination settings can be copied to a song.
- Sequencer data such as a song or cue list that you create can be saved in this instrument's native format, or transmitted as a MIDI data dump.
- A song you created can be converted into SMF (Standard MIDI File) data. SMF songs can also be loaded.
- The **PLAY/MUTE/REC** and "SOLO On/Off" let you instantly play/mute any desired track.
- You can rewind or fast-forward while listening to the sound.
- The [LOCATE] key lets you move quickly to a desired location.
- If the EXB-SMPL (sold separately) option is installed, multisamples you create can be played in Sequencer mode together with the internal programs. The Time Slice function of Sampling mode lets you divide a rhythm loop sample and create performance data that corresponds to the divided samples. In Sequencer mode you can play this performance data, and adjust the playback tempo without affecting the pitch of the rhythm loop sample. You can also exchange the note numbers of the data, or modify the timing to freely re-create the original rhythm loop.

The structure of Sequencer mode

The following describes the structure of Sequencer mode. (see diagram below)

Songs

A song consists of tracks 1–16, a master track, song parameters such as the song name, effect, arpeggiator and RPPR parameters, and 100 user patterns.

A maximum of 200 such songs can be created on this instrument.

Tracks 1–16 and the master track each consist of **setup parameters** located at the start location, and **musical data** within the track.

Setup parameters

Tracks 1–16

Bank/Program No.*, PLAY/MUTE/REC, Pan*, Volume*, Track Play Loop, Loop Start Measure, Loop End Measure, Status, MIDI Channel, Bank Select (When Status=EX2), Force OSC Mode, OSC Select, Portamento*, Transpose**, Detune**, Bend Range**, OSC On/Off Ctrl, Delay, Use Program's Scale, MIDI Filter, Key Zone, Velocity Zone, Track Name, IFX/Indiv.Out BUS Select, Send1(MFX1)*, Send2(MFX2)*

Master track

Time signature*, Tempo*

Musical data

Tracks 1–16

Note On/Off, Program Change (including Bank Select), Pitch Bend, After Touch (Poly After), Control Change, Pattern No.

* When you change the setting during realtime-recording, this will be recorded as musical data. This allows the starting settings to be modified during the playback.

** Musical data (MIDI RPN data) can be used to change the starting settings during playback. For details on control changes and RPN, refer to PG p.233, 236.

Patterns

There are two types of patterns: preset patterns and user patterns.

- **Preset patterns:** Patterns suitable for drum tracks are preset in internal memory, and can be selected for any song.
- **User patterns:** Each song can have up to 100 patterns. When using a pattern in a different song, use the Utility menu commands “Copy Pattern” or “Copy From Song” etc. to copy the pattern. The pattern length can be specified in units of a measure.

Each pattern consists of musical data for one track. It is not possible to create patterns that contain multiple tracks.

These patterns can be used as track musical data by being **placed in a track** (Utility menu command “Put to Track”) or **copied to a track** (Utility menu command “Copy to Track”). Alternatively, you can use a pattern with the **RPPR function of a song**.

Cue List

A **cue list** allows you to playback multiple songs in succession. The TRITON Le allows you to create 20 cue lists. Each cue list allows you to connect a maximum of 99 songs in any order, and to specify the number of times that each song will repeat.

The page menu command “Convert to Song” lets you convert the two or more songs in a cue list into a single song. This allows you to use a cue list to create the backing, then convert the cue list into a song and add solo phrases on unused tracks.

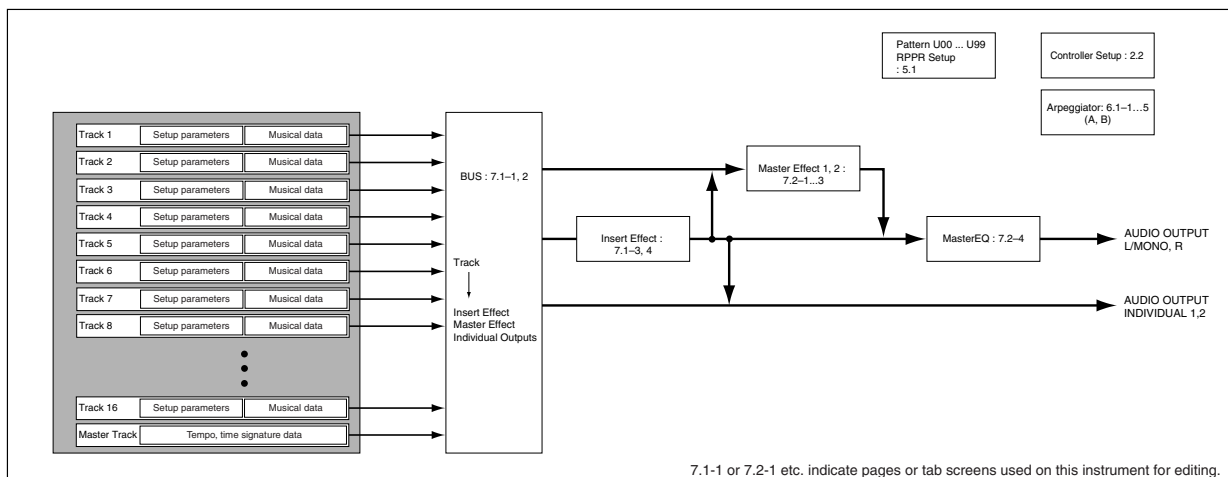

Producing a song

This section describes how to use the TRITON Le's sequencer. As an example, we will create a song by following the order outlined below.

"Creating the basic song"

Here we will use the convenient functions of the TRITON Le's sequencer (e.g., template songs, preset patterns, arpeggiator) to perform realtime recording and step recording.

"Editing the song"

Here we will edit the song that we created in "Creating the basic song."

"Creating a cue list"

Here we will complete the song by creating a cue list for the song that we copied etc. in "Editing the song."

Creating the basic song

1. Loading a template song, and copying preset patterns (drum phrases)

- 1 Turn off the power. Then turn it on again.

 When you turn off the power, all songs will be erased. Be sure to save any important data before you perform this step.

note This explanation assumes that you are starting from the default state immediately after power-on.

- 2 Press the [SEQ] key to enter Sequencer mode.



- 3 Load a template song.

Press the [F8] ("UTILITY") key to access the Utility menu, and then use the [F7] key or the cursor keys to select "Load Template Song" and press the [F8] ("OK") key.

A dialog box will appear.



Make sure that the template song name at the right of "From" is highlighted, and use the VALUE controller to select P13: Acid Jazz.

note There are 16 **template songs**, each containing program, pan, volume, and effect settings suitable for various styles of music. By loading a template into a song, you can begin recording immediately without having to make the same frequently-used settings each time. If you want to specify the program and volume etc. yourself from scratch, refer to "Making track settings for a new song" (p.68).

Use the cursor keys to move to "Copy Pattern to Track too?" Press the [INC] key to check the check box.

If this is checked, a drum pattern will be copied to the song after the template song is loaded.

Press the [F8] ("OK") key to load the template song.

A dialog box will appear.



Make sure that Preset, P109: AcidJazz 1/Std2 is selected at the right of "Pattern." If not, use the VALUE controller to select it.

You can press the [START/STOP] key to hear the selected pattern. To stop, press the [START/STOP] key once again.

Press the [F6] ("Copy") key to copy the pattern.

The "Measure" value will change from 001 to 009. This indicates that the pattern has been copied from measure 1 to measure 8, and that the next time you press the [F6] ("Copy") key, the pattern will be copied from measure 9.



Press the [F7] ("Exit") key.

In the SEQ 1.1: Play/REC, Play/REC page, the "Song Select" field will indicate S000: Acid Jazz.



note Preset patterns can be used in a song even after the above steps. This can be done by using the Utility menu commands "Put Pattern" or "Copy Pattern" (SEQ 5.1: RPPR, Pattern page) (p.70).

- 4 When you play the keyboard, you will hear the drum program for track 1 of the template song that was loaded.

- 5 Press the [▼] key to select "Track Select" T01: Drums.

"Track Select" is the track that will be used to record/play song data. Normally, the track selected here can be played from the keyboard, and during recording, your performance will be recorded on this track (in cases other than Multi REC or Master Track).

Use the VALUE control to select T02: Bass, and play it from the keyboard. Next select T03–T08 in order, and play them from the keyboard. (The

TRITON Le has sixteen sequence tracks, but this template song specifies only tracks 1–8.)

Select T03: Elec.Piano.



- ⑥ Press the [START/STOP] key to play back the preset pattern that you copied. Play the keyboard while you listen to the drum pattern.
- ⑦ Press the [START/STOP] key to stop.

2. Repeatedly playing specific measures of a track (Track Play Loop)

Here's how to use Track Play Loop to repeatedly play back a drum phrase.

- ① Press the [MENU] key to access the page menu.

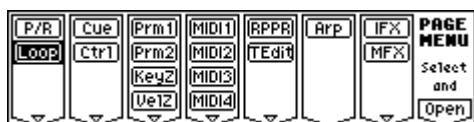

Press the [F1] key to select "Loop," and press the [F8] ("Open") key.

The SEQ 1.2: Loop, Track Play Loop page will appear.

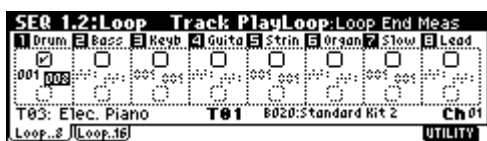

- ② Check track 1 "Loop On," leave "Loop Start Meas" as it is, and set "Loop End Meas" to 008.
- ③ When you press the [START/STOP] key, the drum phrase will be played back repeatedly.

When the playback has repeated for the number of measures in the song as specified by "Length" (the power-on default is 64 measures), it will stop automatically.

note By using "Play Intro" you can begin the loop after adding an introduction (PG p.57).

note Track Play Loop will continue repeating for the number of measures specified by "Length." If you want to limit the number of repetitions or place other performance data (e.g., a drum fill-in) in that track, you will need to expand the pattern into actual performance data. Use the SEQ 5.2: Track Edit Utility menu command "Repeat Measure" to specify the number of playback repetitions and expand the pattern as playback data. In the sample illustration below, performance data will be created to play measures 1–8 of track 1 for four times (i.e., 32 measures).

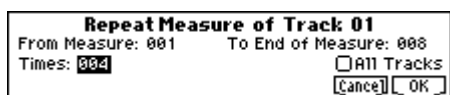

3. Recording the bass track

- ① If playback is occurring, press the [START/STOP] key to stop playback.

Press the [LOCATE] key to return to the beginning of the song.

The location will indicate 001:01.000.

- ② Press the [EXIT] key to access the 1.1: Play/REC page.
- ③ Use "Track Select" to select the track that you want to record.

In this example, select T02: Bass.



Press the [START/STOP] key to start playback, and practice playing the phrase that you want to record.

When you are finished rehearsing, press the [START/STOP] key to stop playback.

Press the [LOCATE] key.

note When the power is turned on, the "Recording Mode" of the TRITON Le will be set to **Over Write recording**, in which newly recorded data will be overwritten. For details on other recording modes, refer to p.78 and PG p.56.

note When recording rapid or difficult phrases, you can slow down the tempo and record at a more comfortable tempo. Simply adjust the "Tempo." After recording, restore the original tempo.



note You can use the **Quantize** and **Resolution** functions to correct the timing of your performance as it is recorded.

For example during realtime recording, suppose that you input eighth notes at slightly inaccurate timing, as shown in line 1 of the diagram below. If you set "Reso" (Resolution) to ♩ and performed realtime recording, the timing would automatically be corrected as shown in line 2. With a setting of **Hi**, the performance will be recorded with the exact timing at which it was played.

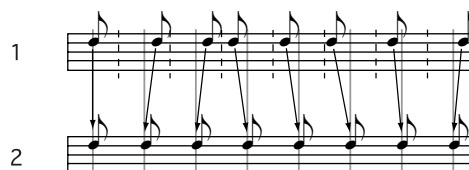



There is also a “Quantize” function (SEQ 5.2: Track Edit Utility menu command) which corrects the timing of performance data after it has been input. If you have already recorded (without using realtime quantize) and later notice during playback that the timing is not quite right (as in line 1 of the preceding diagram), you can select the SEQ 5.2: Track Edit Utility menu command “Quantize,” set “Resolution” to ♩, and press the [F8] (“OK”) key to correct the timing as shown in line 2.

④ Press the [REC/WRITE] key.

You will hear the metronome. The TRITON Le will be in record-ready mode. (Refer to PG p.57 for details on metronome settings.)

⑤ Press the [START/STOP] key.

After a two-measure count, recording will begin. **Play the keyboard for about 16 measures, and record your performance.**

If you make a mistake or decide to re-record, press the [START/STOP] key to stop recording, and press the [COMPARE] key.

When you press the [COMPARE] key to execute the Compare function, you will return to the state prior to recording. (Refer to p.77 for the content that can be compared in Sequencer mode.)

⑥ When you are satisfied with your performance, press the [START/STOP] key to stop recording.

note For example if your performance in measures 5–8 was the best take, you can use the Track Play Loop function to repeatedly play back just this portion. In the SEQ 1, 2: Loop, Track Play Loop page, check “Loop On” for track 2, set “Loop Start Meas” to 005, and set “Loop End Meas” to 008.

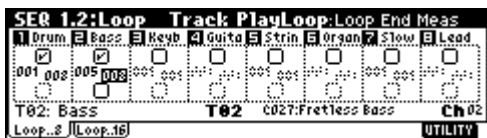

When you press the [START/STOP] key, repeated playback will begin.

note After you press the [START/STOP] key to stop playback, we recommend that you press the [LOCATE] key to return to the beginning of the song. After recording, you will automatically return to the measure at which recording began.

4. Recording arpeggio patterns

The performance of an arpeggio pattern can be recorded into a song. With the settings of this template song, the arpeggiator will function on track 4.

① In “Track Select,” choose T04: Guitar.



② Press the [ARP ON/OFF] key.

③ Press the [START/STOP] key and play single notes or chords.

Verify that arpeggios are sounded in synchronization with the tempo of the drum and bass performance, and rehearse your performance.

④ Press the [START/STOP] key to stop playback. Then press the [LOCATE] key to move the location to the beginning of the song.

⑤ Start recording. Press the [REC/WRITE] key, and then press the [START/STOP] key.

If you play notes on the keyboard during the count-in, the arpeggio will begin at the same time that recording begins, and then that pattern will be recorded.

Play the keyboard for about 16 measures and record your performance.

Press the [START/STOP] key to stop recording.

If you made a mistake or would like to re-record, you can use the Compare function (press the [COMPARE] key) to re-record as many times as you wish.

note The arpeggio pattern is recorded as the note data that was generated. If you operate ARP-GATE or ARP-VELOCITY while recording an arpeggio pattern, this data will be recorded, but it will not be possible to add changes by overdubbing ARP-GATE or ARP-VELOCITY data afterward for those notes.

5. Recording other tracks

① As described in “Recording the bass track,” use “Track Select” to select T03: Elec.Piano, and record about 16 measures.

6. Step recording

The TRITON Le provides two main methods of recording a song. The first is **realtime recording**, in which your performance on the keyboard and operations of the joystick and other controllers are recorded in real-time. This is how we recorded the bass and electric piano tracks in the preceding sections.

The second method is **step recording**, in which you can specify the timing, note length, and velocity etc. in the LCD screen, and use the keyboard to input the pitch of the note. only the note-on/off data is recorded. Step recording is suitable when you want to create a distinctive mechanical feel, or when you want to

record phrases that would be impossible or too rapid to play “live.”

note Rapid phrases can also be recorded in realtime by temporarily slowing down the sequencer tempo.

Here’s the procedure for step recording.

- 1 Press the [MENU] key to access the page menu. Press the [F5] key to select “TEdit,” and press the [F8] (“Open”) key.

The SEQ 5.2: Track Edit screen will appear.



- 2 Press the [▼] key to set “Track Select” to T08 (Ch:08) Lead Synth.

For this example we will input a lead performance using an analog synthesizer sound.

- 3 Press the [←] key to select “Measure (From),” and press the [DEC] key to set this to M:001.

With this setting, step recording will begin from measure 1.

- 4 Press the [F8] (“UTILITY”) key to display the Utility menu, press the [F7] key or the cursor keys to select “Step Recording,” and press the [F8] (“OK”) key.

A dialog box will appear.

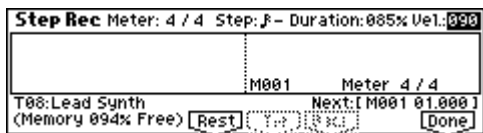

- 5 Press the [▶] key to select “Step.” Press the [INC] key or [DEC] key to select ♪ (16th note).

The step indicates the basic note value (length of a note or rest) that will be used when entering notes from the keyboard.

To input a triplet or dotted note, select the “-” at the right, and press the [INC] key or [DEC] key. Select “3” for a triplet, or “.” for a dotted note.

“Duration” indicates the length that the note itself will sound. Smaller values will produce a staccato note, and larger values will produce a legato note. For this example, leave this setting unchanged.

“Vel.” is the velocity (playing strength), and larger values will produce a louder volume. Set this to about 090.

If you select Key for this parameter, the velocity with which you actually played the keyboard will be input.

- 6 On the keyboard, press and then release the first note that you want to input.

The LCD screen will show numerical values for the data that you input. In the lower right, Next:[M001 01.000] will change to [M001 01.048], and when you

input the next note, the data will be input at that location.

Continue pressing notes to input a melody.

note You can also delete notes or rests, or input rests or ties. (PG p.75)

- To delete a note or rest that you input, press the [F6] (“Back”) key. The previously-input note will be deleted.
- To input a rest, press the [F4] (“Rest”) key. This will input a rest of the “Step” value.
- To modify the length of a note, you can modify the “Step” value before you input the note. However if you want to extend the length (tie) of the note, press the [F5] (“Tie”). At this time, the previously-input note will be extended by the length of “Step.”



note If you want to check the note that you will input next, press the [PAUSE] key. In this state, playing a key will produce sound, but will not input a note. Press the [PAUSE] key once again to cancel the record-pause state, and resume input.

note To input a chord, simultaneously press the notes of the desired chord. Even if you do not press them simultaneously, notes that were pressed before you took your hand off of all keys will be input at the same location.

However in the above example, the program of track 8 will not sound chords. This is because the program is set to mono mode, and the song follows the setting of the program. In other words because this track is set to “Force OSC Mode” PRG, the “Voice Assign Mode” setting of Mono for the program B042: Express Lead remains valid.

- 7 When you are finished inputting, press the [F8] (“Done”) key.

- 8 Press the [START/STOP] key to play back.

When you begin step recording, all data following the recorded measure will be erased from that track.

You need to be aware of this if you begin step recording from a measure mid-way through the song.

If you want to re-input data into a measure that already contains data, perform step recording in another un-recorded track, and execute “Move Measure” or “Copy Measure” (PG p.78).

If you want to edit or add to the recorded data, you can use the “Event Edit” function (PG p.75).

7. Using controllers to record tonal changes

Let's try using the realtime controllers and the joystick to add effects to the performance that we just step-recorded on track 8.

- 1 Press the [EXIT] key, and then press the [F6] ("Pref.") key to move to the SEQ 1.1: Play/Rec, Preference page.
- 2 Set the "Recording Mode" to Over Dub.

Over Dub allows you to add to a previously-recorded track.



- 3 For "Track Select," make sure that T08: Lead Synth is selected.

Press the [START/STOP] key to start playback, and operate the realtime controllers and joystick to rehearse. When you are finished rehearsing, press the [START/STOP] key to stop. Press the [LOCATE] key.

- 4 Start recording.

Press the [REC/WRITE] key, and then press the [START/STOP] key.

After a two-measure count-in, recording will begin.

Operate the LFO CUTOFF or RESONANCE/HPF realtime controllers or the joystick ($\pm Y$ axis) to record their movements.

When you are finished performing, press the [START/STOP] key.

If you make a mistake or want to re-record, press the [COMPARE] key to execute the Compare function, and then re-record.

8. Saving the song

Remember to save the song you created. The data will be lost when the power of the TRITON Le is turned off. Refer to p.45 for the Save procedure.

Convenient functions for song production and checking the track settings

Monitoring just a specific track/Muting just a specific track (Solo/Mute functions)

The TRITON Le provides a Solo function that lets you play only a specific track 1–16, and a Mute function that silences only a specific track. These functions can be used in various ways. For example you can intentionally mute or solo specific tracks, or listen only to the rhythm section of the previously-recorded tracks while you record new tracks.

Let's try out the Mute and Solo functions.

- 1 In SEQ 1.1: Play/REC, press the [F2] ("Prog.8") key to access the Program page.

Press the [START/STOP] key.

- 2 Select the track 1 "PLAY/MUTE/REC," and press the [INC] key once.

The display will change to "MUTE," and the playback of track 1 will no longer be heard. In this way, the "mute" function allows you to silence a specified track until the track is un-muted.



Select the track 2 "PLAY/MUTE/REC" and press the [INC] key once.

- note** When selecting the parameters of various tracks as above, you can also make your selection by holding down the [TIMBRE/TRACK] key and pressing one of the [F1] (T1/T9)–[F8] (T8/T16) keys.

The display will change, and the playback of track 2 will also be muted.



To cancel muting, press the "PLAY/MUTE/REC" and press the [DEC] key.

- 3 Next select the track 1 "SOLO On/Off" and press the [INC] key once.

The display will change, and now only the track 1 playback will be heard. In this way, the Solo function lets you hear only a specified track.

- note** If both Mute and Solo are used, the Solo function will be given priority.)



Press the track 2 "SOLO On/Off" and press the [INC] key once.

The display will change, and only the playback of tracks 1 and 2 will be heard.



To turn off the Solo function, select the “SOLO On/Off” and press the [DEC] key once again. Select the track 1 and 2 “SOLO On/Off” and press the [DEC] key once each.

The display will change, and the playback of tracks 1 and 2 will be muted. If the Solo function is turned off for all tracks, playback will be according to the “PLAY/MUTE/REC” settings.

note By using the Utility menu command “Solo Selected Track,” you can listen to the sound of only the selected track. This is convenient when you want to set track parameters or to make effect settings. (PG p.51)

[LOCATE] settings

By pressing the [LOCATE] key you can move to a specified location.

The location is specified by the Utility menu command “Set Location.” You can also hold down the [ENTER] key and press the [LOCATE] key to set the location even during playback (PG p.53).

Normally you will set this to 001:01.000. You will return to the beginning of the song.

When you select a song, the [LOCATE] setting will automatically be set to 001:01.000.

Making track settings for a new song

Here’s how to make basic settings for a new song, such as assigning a program to each track, and setting the volume etc. You can check these settings for the template song you loaded earlier.

1. Assign a program to each track (SEQ 1.1: Play/REC, Program page)



In the SEQ 1.1: Play/REC, Program page, use “Program Select” to assign a program to each track.

At this time you can also use the Utility menu command “Select by Category” to select programs by category (PG p.55).

You can also use the Utility menu command “Copy From Combi” to copy settings from a combination (p.75, PG p.52).

note When assigning a program, you can use “Track Select” to select the track for which you are making assignments, and try playing the sound.

2. Set the pan and volume of each track (SEQ 1.1: Play/REC, Mixer page)



In the SEQ 1.1: Play/REC, Mixer page, “Pan” sets the pan of each track, and “Volume” sets the volume of each track.

3. Specify the tone generator and MIDI channel that will sound each track (SEQ 3.1: Param 1, MIDI page)

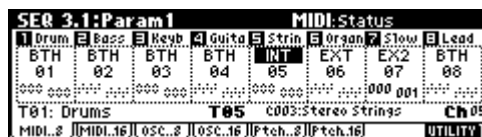

In the SEQ 3.1: Param1, MIDI page, “Status” specifies whether each track will sound the internal tone generator or an external tone generator. “MIDI Channel” specifies the MIDI channel for each track.

If the track status “Status” is set to INT, playing the track data or operating the TRITON Le’s keyboard or controllers will cause the TRITON Le’s internal tone generator to be sounded and controlled.

If “Status” is set to EXT, EX2, or BTH, playing the track data or operating the TRITON Le’s keyboard or controllers will cause an external tone generator to be sounded and controlled. (The MIDI channel of the external tone generator must be set to match the “MIDI Channel” of TRITON Le tracks that are set to EXT, EX2 or BTH.)

If “Status” is set to BTH, both the external tone generator and the TRITON Le’s own tone generator will be sounded and controlled.

If you are using the TRITON Le’s Sequencer mode as a 16-track multi-timbral tone generator, set this parameter to INT or BTH. (“Status” PG p.62)

In general, you should set “MIDI Channel” to different channels 1–16 for each track. Tracks that are sent to the same MIDI channel will sound simultaneously when either is recorded or played.

4. Make effect settings (SEQ 7.1: Insert FX, SEQ 7.2: Master FX)

Make settings for each effect in SEQ 7.1: Insert FX and SEQ 7.2: Master FX. (p.110, PG p.84)

5. Set the tempo and time signature (SEQ 1.1: Play/REC)

Make these settings in SEQ 1.1: Play/REC. “Tempo” sets the tempo, and “Meter” sets the time signature. (PG p.50)

6. Make other settings as necessary

As necessary, make arpeggiator settings (SEQ 6.1: Arp.) and MIDI filter settings (SEQ 4.1–4.4: MIDI Filter 1–4). (PG p.49–86)

When you are finished making these settings, the basic setup is complete. Record as described in "3. Recording the bass track" (p.64) and following sections.

Song editing methods

A song can be edited in a variety of ways. Here we will explain various ways in which the song we recorded in the preceding pages can be edited for the purpose of creating a Cue List (explained in the section that follows).

1. Copying a song

Here's how to copy a song. This is convenient when you want to create different variations based on a song.

① Create a new song.

Press the [EXIT] key to display the SEQ 1.1: Play/REC page. Choose "Song Select," use the **numeric keys** to input the song number that you want to newly create, and press the [ENTER] key. (For example, press the [1] key and then the [ENTER] key.) A dialog box will appear.



Decide on the number of measures, input the number in "Set Length," and press the [F8] ("OK") key.



A new song will be created. Next we will copy the song settings and playback data of another song into this newly created song.

② Select the Utility menu command "Copy From Song," and press the [F8] ("OK") key.



A dialog box will appear. Select the song that you want to copy (i.e., the copy source). If you select **All**, all song settings and playback data will be copied from that song. If you select **Without Track/Pattern Events**, settings other than Play Loop and RPPR will be copied. **For this example, select All.**

Press the [F8] ("OK") key to execute the copy.

③ As described in steps ① and ②, create one more new song (S002), and copy song S000 to it.

2. Naming a song

Here's how to assign a name to a song you created.

① Choose "Song Select," and use the VALUE controller to select a song. For this example, select song 002.

② In the SEQ 1.1: Play/REC page, select the Utility menu command "Rename Song," and press the [F8] ("OK") key.

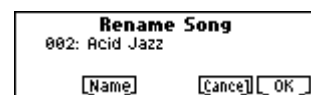

A dialog box will appear. Press the [F5] ("Name") key to access the text dialog box.

Press the [F1] ("Clear") key, and input CHORUS (p.43).

When you are finished inputting the name, press the [F8] ("OK") key.

Press the [F8] ("OK") key once again to execute the Rename operation.

③ As described in steps ① and ②, assign a name of INTRO to S000, and VERSE to S001.

3. Setting the number of measures in the song

Here's how to specify the number of measures in the song. When the power is turned on, this is set to **64 measures**. If you realtime-record for more measures than this, the song will be the length of the measures you recorded.

① Select song S000: INTRO.

② Select the SEQ 5.2: Track Edit page.

In the SEQ 5.2: Track Edit page, press the [MENU] key to access the page menu, select the [F5] ("TEdit") key, and then select [F8] ("Open").



③ Press the [F8] ("UTILITY") key to access the Utility menu.

This contains various commands for editing tracks and measures.

Select "Set Song Length," and press the [F8] ("OK") key.

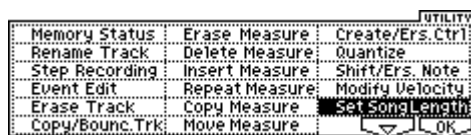

A dialog box will appear.



Input the number of measures for the song. For this example, select 008 (8 measures) and press the [F8] (“OK”) key.

The performance data from measures 1–8 will remain, and the data of subsequent measures will be deleted. When you press the [START/STOP] key to play the song, playback will stop at the end of the 8th measure.

- ⚡ If you are using Track Play Loop, check whether the measures specified for “Loop Start Meas” and “Loop End Meas” would be deleted. If they would be deleted, use “Move Measure” (≡PG p.78) etc. to move the data into the playback area before you execute this operation.

④ Mute tracks.

Press the [EXIT] key to select SEQ 1.1: Play/REC, and access the Program page.

Mute all tracks other than tracks 3 and 4. When you play back, you will hear only the electric piano and guitar performances.



- ⑤ As described in steps ①–④, set song S001: VERSE to 008 (8 measures), making it an eight measure song.

Then mute all tracks other than tracks 1–3. When you play back, you will hear only the drums, bass, and electric piano.

- ⑥ As described in steps ①–④, set song S002: CHORUS to 008 (8 measures), making it an eight measure song.

4. Changing the key (transposing/modulating)

Here’s how to change the key of a song.

- ① Select song S002: CHORUS.
- ② Select the SEQ 5.2: Track Edit page.
- ③ Use the [▲], [▼] keys to select track T02 for the key change.
- ④ Specify the measures for which the key will be changed.

Press the [←] key to select “Measure (From),” and use the VALUE controller to set this to 001. Next press the [→] key to select “Measure (To End of),” and set this to 008.



- ⑤ Press the [F8] (“UTILITY”) key, select the Utility menu command “Shift/Ers.Note,” and press the [F8] (“OK”) key.

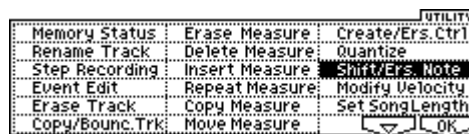

A dialog box will appear. If you did not specify the range of measures in step ④, set “From Measure”–“To Measure” to specify the range that will be edited.

Set “Mode” to Shift (Replace), and set the value to +003. (≡PG p.80)

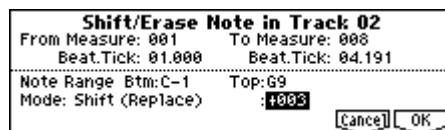

Press the [F8] (“OK”) key. The pitch of track 2 will be raised three semitones.

- ⑥ Use the same procedure to raise the pitch three semitones for each track on which performance data is recorded. However, do not change the key of track 1 which uses a drum kit.

- ⚡ If you change the key of a track that is using a drum kit, the relationship between the notes and the instruments of the drum kit will be shifted, so that the rhythm instruments will not sound correctly.

About editing

Song editing

In addition to copying and renaming a song, other operations such as Delete can be performed from the Utility menu commands in pages such as SEQ 1.1: Play/REC (≡PG p.52).

Track editing

Event Editing allows you to edit or insert data in a recorded track. In addition, commands such as Create Control Data (which lets you insert bend, aftertouch, or control change data) and other commands for deleting, copying, inserting, or moving tracks can be accessed from the Utility menu command in pages such as SEQ 5.2: Track Edit (≡PG p.75).

Pattern editing

Using the Utility menu commands of the SEQ 5.1: RPPR, Pattern page, you can use event editing to modify the recorded data or insert new data, and execute commands to delete, copy, or bounce patterns (≡PG p.70).

Creating and playing a Cue List

A **cue list** allows you to play multiple songs in succession. For example you can create a separate song for each portion (introduction, melody A, melody B, chorus, and ending) of a composition, and use the cue list to specify the order of each portion and the number of times that it will be repeated to complete the song. If you want to change the structure of the song, the cue list lets you do so in an efficient way. You can also use this as a jukebox function that will playback completed songs in the order you specify.

Step	Song	Repeat
01	S000: Intro	02
02	S001: A	02
03	S002: B	01
04	S003: Chorus	02
05	S001: A	02
06	S002: B	01
07	S003: Chorus	02
08	S001: A (Solo)	01
09	S003: Chorus	03
10	S004: Ending	02

Intro	Intro	A	A	B	Chorus
Chorus	A	A	B	Chorus	Chorus
A(Solo)	Chorus	Chorus	Chorus	Ending	Ending

Each unit in a cue list is called a “**step**,” and each step contains a song number and the number of repeats.

Here we will use a cue list to combine the previously-created songs **S000: INTRO**, **S001: VERSES**, and **S002: CHORUS**.

① Select SEQ 2.1: Cue List.

With the default settings, song **S000** will be selected for “Step” 01, and **End** will be selected for “Step” 02.



② Press the [F7] (“EDIT”) key

You will be able to insert or delete songs into or from the cue list.



③ Add a song to the Step area.

Use the cursor keys to select **Step 02**, and press the [F4] (“**INSERT**”) key. A song will be added to step 02. Use the VALUE controller to select **S001: VERSES**.

In the same way, select **Step 03**, and press the [F4] (“**INSERT**”) key to add a song to Step 03. Set this step to **S002: CHORUS**.

If you press [F5] (“**CUT**”), the selected step will be deleted. If you press the [F4] (“**INSERT**”) key, that step will be inserted. If you press the [F6] (“**COPY**”) key, the selected step will be copied. If you press the [F4] (“**INSERT**”) key, that step will be inserted.

④ Set the last step to End.

If you set this to **Continue to Step01**, the cue list will playback repeatedly.

⑤ In “Rep (Repeat),” specify the number of times that the song for that step will be repeated. For this example, set Step 02 S001: VERSES to 02.

⑥ Specify whether effect settings will also be switched when the song at each step is played back. If you want to effect settings to change, check the “FX” check box.

For this example, check the “FX” check box for **Step 01**, which loads the effects.

⑦ When you are finished making settings for each step, press the [F7] (“DONE”) key.

⑧ To playback at the tempo that was specified for each song, set “Tempo Mode” to Auto.

If this is set to **Manu (Manual)**, playback will use the tempo specified by “♩=”.



⑨ When you press the [START/STOP] key, playback will begin from the step that is specified as the “Current Step.”

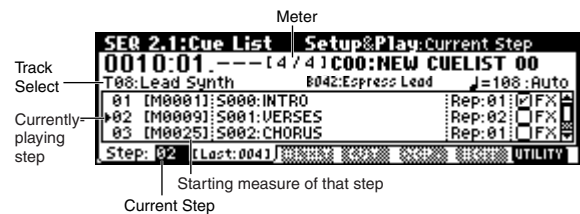

- “**Step**”: The arrow will indicate the currently playing step. ▶ indicates the currently selected “Step.” If you set “**Current Step**” while stopped, the display will change.
- “**M******”: Indicates the starting measure of that step.
- “**Meter**”: Indicates the currently-playing time signature. This cannot be changed.
- The name of a cue list can be specified by the “**Rename Cue List**” page menu command.
- When you play the keyboard, the program of the track selected by “**Track Select**” will sound. If a different program is selected for each song, the program specified for the currently playing song will sound.

note Cue list editing will automatically end if you press the [START/STOP] key, etc. (**DONE** → **EDIT**)

If playback is not connected smoothly between songs when playing a cue list

Depending on the effect settings, a certain amount of time may be required for the effects to be switched. If this occurs, the playback will not be smoothly connected from song to song.

To ensure a smooth transition from song to song, check "FX" for "Step" 01. Do not check "FX" for the remaining steps. This way, the effect settings will be made before playback begins, and there will be no time lag when cue list playback is started or when switching from song to song. Although it will not be possible to change effect types within the cue list, you can use dynamic modulation or MIDI control changes such as Effect Control to control the effects within the cue list, for example applying reverb more deeply on certain songs, or raising the LFO speed for a specific song. We recommend this method if you will be using a cue list to construct the song. When you execute the Utility menu command "Convert to Song", the effect settings of the "Step" 01 song will be specified for the song that results from the conversion.

Even if "FX" is not checked, there may be cases in which a time lag in the transition between songs, depending on the musical data of the song. Also, there may be cases in which the musical data is not played at the correct timing at the transition between songs. If this occurs, you can edit the musical data of the song, or convert the cue list to a song for playback. If you use "Convert to Song" to convert the cue list to a song, there will be no time lag during playback at the transition between songs, and the musical data will be played at the correct timing.

Creating multiple songs for use in a cue list

If you want to create multiple songs for use in a cue list, it is a good idea to make the various necessary settings (program and other settings for each track, effect settings, etc.) for one song (e.g., S000), and then use the Utility menu command "Copy From Song" in SEQ 1.1 etc. to copy it to other songs so that the settings will be consistent.



After your cue list is finished and you convert it into a song, the track settings (program, pan, volume, etc.) of each step will be converted into playback data and will be reproduced, but if the MIDI channel settings do not match, it may not be possible to convert the playback state of the cue list into a song.

Using a foot switch to switch the Step

You can use a foot switch to switch the Step. If you set "Rep(Repeat)" to FS, a foot switch connected to the ASSIGNABLE SWITCH jack will control the timing at which the song stops repeating. Set "Foot SW Assign" (GLOBAL 1.1: Syatem, Foot page) to Cue Repeat Control.

Converting a cue list to a song

Although it is not possible to record additional material onto tracks in a cue list, you can convert a cue list to a song, and then record solos etc. on vacant tracks. You will also need to convert a cue list to a song if you wish to save it on a SamartMedia as SMF data.

- 1 Select the Utility menu command "Convert to Song".

A dialog box will appear.

- 2 In "To," specify the destination song number for the converted data.

The cue list name will automatically be assigned as the song name of the converted data. (For details and cautions regarding "Convert to Song," refer to PG p.60.)

If you wish to select a new song as the convert destination, use the numeric keys [0]–[9] to specify the song number, and then press the [ENTER] key. It is not necessary to set "Set Length" in the dialog box that appears at this time. The number of measures in the converted song will be used. Press the [F8] ("OK") key, and the Convert Cue List dialog box will appear.

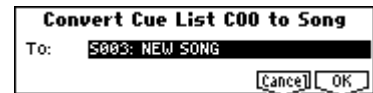

- 3 Press the [F8] ("OK") key.

The cue list will be converted into a song. Access the SEQ 1.1: Play/REC page, select the song number that you specified as the conversion destination, and check the results.



Creating and recording RPPR (Realtime Pattern Play/Record)

This section explains how to assign a pattern to RPPR, and how to play and record. (“Playing with the RPPR function” p.30)

Creating RPPR data

① Create a new song. (p.69)

② Specify the program for each track.

For this example we will use a template song. Use the Utility menu command “Load Template Song” to load **P14: Hip Hop/Rap**. It is not necessary to copy the patterns. (p.63)

③ Select the SEQ 5.1: RPPR, RPPR Setup page.

In this page, the RPPR function is automatically turned on.



④ Use “KEY” to select the key to which the pattern will be assigned.

Select **C#2**. This can also be selected by holding down the [ENTER] key and playing a note.

C2 and lower keys are used to stop playback, and cannot be assigned.

⑤ Check the “Assign” check box.

⑥ Set “Pat (Pattern Bank)” to the Pre pattern type, and set “Pattern Select” to pattern **P121: HipHop 1/HipHop**.

⑦ Set “Track” to **T01: Drums**.

The selected pattern will be played according to the settings (program, etc.) of the track you select here.

⑧ Assign patterns to other keys.

Set “KEY” to **D2**.

Press the [F4] (“REVERT”) key.

The settings for “Assign,” “Pat (Pattern Bank),” “Pattern Select,” and “Track” will be set to the values that were specified earlier (in steps ⑤–⑦).

Choose “Pattern Select,” and press the [INC] key once to select **P122: HipHop 2/HipHop**.

note By using “REVERT” in this way, you can work efficiently when the patterns to be assigned have consecutive or nearby numbers, or use the same track.



Use the above method to assign several patterns from the range of **P123: HipHop 3/HipHop–P135: HipHop 15/HipHop**.

⑨ Press the **C#2** key.

The assigned pattern will play.

Take your finger off the **C#2** key, and press the **D2** key.

The pattern will change, and playback will begin. At this time, the pattern operation will depend on the “Sync” and “M (Mode)” setting.

Set “KEY” to **C#2**, and set “Sync” to **Measure**. Make the same setting for **D2**.

Now press the notes consecutively. Notice that the patterns operate in a different way.

With the “Measure” setting, patterns will be handled in one-measure units. The second and subsequent patterns to be started will start in synchronization with units of a measure relative to the pattern that was started first.

If you change the “M (Mode)” setting to **Once**, the entire pattern will playback to the end even if you release your finger from the keyboard immediately.

note To stop playback, either press the same key once again, or press the **C2** or lower key.

For details on “Sync,” “M (Mode),” and “Shift,” refer to PG p.72.

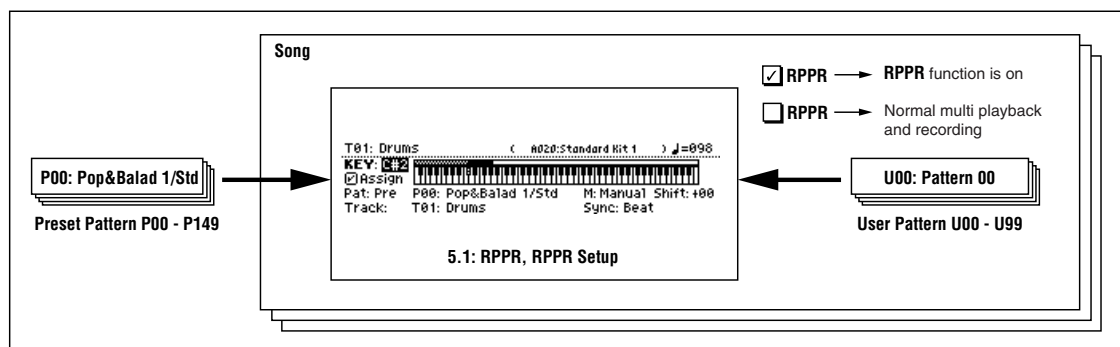

The assigned keys will be shown as a keyboard graphic in the LCD screen.

note Unassigned keys can be used for normal keyboard performance. Use “Track Select” to select the track that will be played from the keyboard. For example you might assign backing patterns such as drums and bass to the C#2–B2 keys and use these keys to control pattern playback, and use keys C3 and above to play solos in realtime. It is a good idea to keep the assigned keys together in this way.

RPPR playback

Let’s use the RPPR you created to perform in the SEQ 1.1: Play/REC page.

- 1 In Sequencer mode, select SEQ 1.1: Play/REC.
- 2 Check the “RPPR” check box.

The RPPR function will be turned on. The on/off setting is memorized for each song.



- 3 Play the keyboard, and patterns will begin playing according to the RPPR settings.

- Pattern playback for a key with a “Sync” setting of **Beat** or **Measure** will synchronize to the pattern playback of the first key. (PG p.72 “Sync”)
- If you are playing the pattern in synchronization (when “Sync” is **Beat**, **Measure**, or **SEQ**), the pattern will start accurately if you play the note slightly earlier than the timing of the beat or measure. Even if you play the note slightly later than the beat or measure (but no later than a 32nd note), it will be considered to have started at the beat or measure, and the beginning of the pattern will be compressed so that the remainder of the playback will be correct.

note If you wish to trigger the RPPR function from an external MIDI device, use the MIDI channel that is selected for “Track Select.”

- 4 To turn off the RPPR function, uncheck the RPPR check box.

Play RPPR while a song plays back

RPPR can be played in synchronization with the playback of a song.

Pattern playback for a key with a “Sync” setting of **SEQ** will synchronize to the playback of the song. (PG p.72 “Sync”)

Start song playback, and then press the key. The pattern playback will start in synchronization with the measures of the song.

⚠ Synchronization will be lost if you use the [◀◀ REW] or [FF ▶▶] keys while a song is playing.

note If you want RPPR pattern playback to begin at the moment that song playback begins, it is a good idea to insert an empty measure containing no musical data before the song playback begins.

note If the song is stopped, the pattern will synchronize to the timing of the arpeggiator function.

Realtime-recording an RPPR performance

An RPPR performance can be recorded in realtime. If you are using only one track (**T01: Drums**) as in “Creating and recording RPPR” (p.73), set “Track Select” to **T01: Drums**, and use **single track recording** in which only one track will be recorded.

Even if RPPR uses only one track, use **multi-track recording** if you will be selecting another track in “Track Select” and recording its performance at the same time.

You should also select **multi-track recording** if you created the RPPR data using multiple tracks rather than just a single track, and want to simultaneously record the performance of multiple tracks.

note The RPPR pattern will be recorded as performance data on the tracks used by the pattern.

Here we will explain how you can simultaneously record a performance that uses both RPPR and the arpeggiator.

- 1 For each RPPR pattern, set “Sync” to **SEQ**.

With a setting of **SEQ**, patterns played by the RPPR function while the sequencer is playing or recording will start in synchronization with the measures of the sequencer.



- 2 We will use the arpeggiator to play the bass pattern. Follow these settings.

Set “Track Select” to **T02: Bass**.

Select the SEQ 6.1: Arp., Setup page, and set the track 2 “Assign” to **A**. (Make sure that **A** is checked for “Arpeggiator Run.”)



Select the SEQ 6.1: Arp., Arp. A page, and set “Pattern” to **U107 (INT)**.

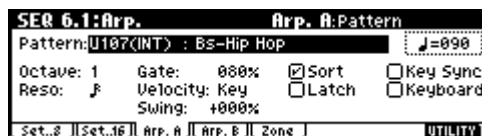

Do not check “Key Sync.”

Press the [ARP ON/OFF] key. (The key will light.)

- ③ In the SEQ 1.1: Play/REC, Preference page, check the “Multi REC” check box.



If “Recording Mode” is set to Loop All Tracks,” it will not be possible to select Multi REC. Set the “Recording Mode” to Over Write.

- ④ Select the 1.1: Play/REC, Program page.

For all tracks, the “PLAY/MUTE/REC” indication will show REC.

The track played by RPPR will be recorded simultaneously with the track played by the arpeggiator. Set “PLAY/MUTE/REC” to PLAY or MUTE for all tracks other than tracks 1 and 2, which we will be recording.

Make sure that “Track Select” is set to T02: Bass. Your keyboard playing on keys not assigned to the RPPR function can be recorded on the track specified by “Track Select.”



- ⑤ In the 1.1: Play/REC, Play/REC page, make sure that the “RPPR” check box is checked.



- ⑥ Press the [LOCATE] key to set the location to 001:01.000.
- ⑦ Press the [REC/WRITE] key, and then press the [START/STOP] key.

Press a key that plays an RPPR pattern, and one or more keys that play the arpeggiator.

If you press a key during the pre-count before recording, the pattern playback and arpeggio performance will begin simultaneously when recording begins, and will be recorded.

Record the RPPR pattern playback and arpeggio performance.

- ⚠ When recording the playback of patterns triggered by RPPR, the timing of the recorded events may be slightly skewed. If this occurs, try setting “Reso” (Realtime Quantize Resolution) to a setting other than Hi.

- ⑧ When you are finished performing, press the [START/STOP] key.

Recording will end, and the sequencer will return to the location at which recording began.

If you made a mistake during your performance or would like to re-record, you can use the Compare function (press the [COMPARE] key) to re-record as many times as you wish.

- ⑨ If you want to record other tracks, un-check the “Multi REC” or “RPPR” check boxes as necessary.

In step ③, uncheck the “Multi REC” check box to defeat multi-track recording.

In step ⑤, uncheck the “RPPR” check box to turn off the RPPR function.

Recording the sounds of a combination

Here’s how you can copy the sounds of a combination to multiple tracks, and record your performance.

note Make sure that the global MIDI channel (GLOBAL 2.1: MIDI, “MIDI Channel”) is set to 01.

- ① Create a new song. (p.69)



- ② Execute the Utility menu command “Copy From Combination.”

A dialog box will appear.

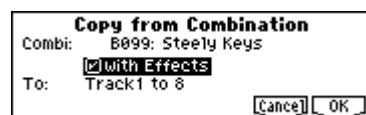

Select the combination that you want to copy (i.e., the copy source).

Press the COMBI BANK [A] key, then press numeric keys [6], [7], and finally press the [ENTER] key. B099: Steely Keys will be selected.

We will copy the effect settings of the combination as well, so check the “With Effects” check box. Since we want to copy the settings of the combination’s eight timbres to tracks 1–8, select Track 1 to 8. Press the [F8] (“OK”) key to execute the copy.

- ③ In the SEQ 1.1: Play/REC, Preference page, check the “Multi REC” check box. (p.75)



When you perform multi-track recording, the multiple channels that are being sounded by the arpeggiator will be recorded simultaneously.

- ④ Set the tracks not being recorded (i.e., tracks 9–16) to PLAY or MUTE. (p.67)
- ⑤ Set “Track Select” to 01.

In order to play the sounds and arpeggiator in the same way as in Combination mode, set “Track Select” to the track that matches the global MIDI channel. When you play the keyboard, the sounds will be heard just as in Combination mode.

⑥ **Begin recording.**

Press the [LOCATE] key to set the location to 001:01.000.

Press the [REC/WRITE] key, and then press the [START/STOP] key.

If you play a B3 note or lower during the pre-count before recording, the arpeggio pattern will start from the beginning at the moment that recording begins. Record your performance.

⑦ **When you are finished performing, press the [START/STOP] key.**

If you made a mistake or want to re-record, you can use the Compare function (press the [COMPARE] key) to re-record as many times as you want. (The “MultiREC” check box will be unchecked when you use Compare, so you will need to check it again.)

If the recorded performance is not reproduced correctly during playback

If you use the Utility menu command “Copy From Combination” to copy the settings of a combination, and then perform multi-track recording with the arpeggiator turned on, there may be cases in which the performance during recording is not reproduced by the playback.

Multiple tracks that are set to the same MIDI channel are combined into a single stream of performance data during recording. If there is a track with the same MIDI channel as the track being played by the arpeggiator, the data played by the arpeggiator will be combined with the performance data that was played manually, and all of this data will be sounded by each track of the same channel (if “Status” is INT).

In such cases, you can solve the problem by changing the MIDI channel of the track that is played by the arpeggiator, and then creating a track that will drive the arpeggiator.

If the recorded performance is not reproduced by the playback, check the following conditions.

- **SEQ 6.1: Arp., Setup page**
“Arpeggiator Run” A, B, and “Assign” settings

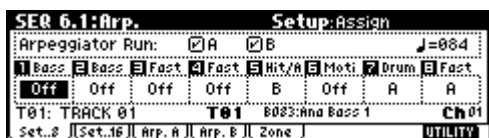

- **SEQ 3.1: Param1, MIDI page** “MIDI Channel” settings

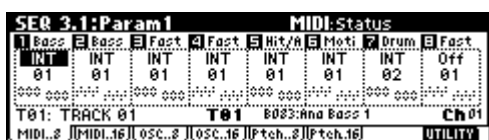

If “Arpeggiator Run” A and B are checked, and the arpeggiator is assigned to a track, make sure that “MIDI Channel” is set to other than 01.

note Make sure that the global MIDI channel (GLOBAL 2.1: MIDI, “MIDI Channel”) is set to 01.

Arpeggiator Run	MIDI Channel ^{*1}	Correction
If either “A” or “B” are checked	01 only	Correction required
	01 02, 01 03, etc.	No correction required
If both “A” and “B” are checked	01 only	Correction required
	01 02, 01 03, etc.	Correction required for only one
	01 02 03, etc.	No correction required/ Correction required ^{*2}

^{*1} If the “MIDI Channel” of multiple tracks operated by the arpeggiator is set only to 01, refer to the lines for “01 only.” If the “MIDI Channel” settings are 01 and one other channel, such as 01 and 02, or 01 and 03, then refer to the lines for “01 02, 01 03 etc.” If the “MIDI Channel” settings are 01 and multiple other MIDI channels, such as 01 and 02 and 03, then refer to the line for “01 02 03, etc.”

^{*2} Correction is necessary only if the tracks operated by a single arpeggiator are using only “MIDI Channel” 01. In some cases, correction may also be necessary if the two arpeggiators use the same MIDI channel.

⚠ Depending on the combination settings, it may also be necessary to change the track settings as well.

In the screens shown above, **combination B071: “In the Pocket”** has been copied using “Copy From Combination.” As described in steps ① and ② of the procedure given earlier, try actually copying this to see for yourself. For the arpeggiator settings of this combination, refer to p.101. Taking this setting as an example, determine whether correction is necessary, and if necessary, what needs to be corrected.

“Arpeggiator Run” A and B are checked, and “MIDI Channel” 01 and 02 are selected. Corrections must be made. Correction is necessary for one of the arpeggiators. If you perform multi-track recording with these settings, the MIDI channels of T01, 02, 03, 04, 05, and 06 are the same, so the low-register bass (T01 and T02), the high-register synth brass/pad (T03, T04 and T06), and the synth mallet played by arpeggiator B (T05) will have their performance data combined into one stream, and the performance will not be reproduced at playback. (T08 is a dummy track used to trigger arpeggiator A.)

- ① **So that the synth mallet played by arpeggiator A can be recorded separately, change the MIDI channel of T05.**

Select the SEQ 3.1: Param1, MIDI T01-08 page, and change the T05 “MIDI Channel” to 03.

- ② **Add settings for triggering arpeggiator A.**

Select the SEQ 3.1: Param1, MIDI T09-10 page, and for track 9 (or any unused track), turn “Status” Off, and set the “MIDI Channel” to 01.

(T09 will be a dummy track used to trigger arpeggiator B.)

- ③ Select the SEQ 6.1: *Arp.*, Setup T09-16 page. Set the track 9 Assign to B.

This will produce the following settings.

Track	T01	T02	T03	T04	T05	T06	T07	T08	T09
Assign	Off	Off	Off	Off	B	Off	A	A	B
Status	INT	INT	INT	INT	INT	INT	INT	Off	Off
MIDI Ch.	01	01	01	01	03	01	02	01	01

This completes the corrections. In the SEQ 1.1: *Play/REC*, Preference page, set “Track Select” to any track whose MIDI channel is 01. Check the “Multi REC” check box and perform multi-track recording.

Caution and other functions in Sequencer mode

TRITON Le song data and its compatibility

The following two types of song data can be loaded from SmartMedia into this instrument’s sequencer.

- **Song data saved in this instrument’s own format**
This data is only for this instrument. However, it is partially compatible with the TRITON/TRITON-pro/TRITONproX/TRITON-Rack (Multi) (PG p.247). It cannot be loaded into other instruments. Since the performance will be faithfully reproduced, including detailed settings of this instrument, you should use this format to save song data that is intended for playback on this instrument.
- **Standard MIDI Files**
This format is not able to provide a totally faithful reproduction of the performance on this instrument in the way that this instrument’s own format does (although there will be no problem for normal playback), but does provide compatibility with other SMF-compatible devices.

To load song data from SmartMedia or save song data to SmartMedia, use Media mode. (PG p.45, PG p.139)

The Compare function

When you perform realtime recording, step recording, or track editing, this function allows you to make before-and-after comparisons.

- ▲ If you continue editing when the [COMPARE] key is lit, the key will go dark. This now becomes the musical data that will be selected when the [COMPARE] key is dark.

Operations for which Compare is available

- **Recording to a track**
- **Track Edit**
All commands except for the Utility menu commands “Memory Status” and “Rename Track” of the SEQ 5.2: Track Edit page.

- **Recording to a pattern**
- **Pattern Edit**
All commands except for the Utility menu commands “Memory Status,” “Rename Pattern,” “FF/REW Speed,” and “Rename Track” of the SEQ 5.1: RPPR, Pattern page.
- **Song Edit**
SEQ 1.1-4.4 and 6.1–6.4 pages: Utility menu commands “Delete Song” and “Copy From Song”
SEQ 2.1: Cue List page: Page menu commands “Convert to Song” and “Copy Song”

In general, track and pattern event data can not be returned to its original state.

Comparing song parameters is possible only during song editing (when executing a Utility menu command).

Operations for which Compare is not available

- Editing song parameters
- Utility menu commands other than those listed above (in Operations for which Compare is available)

Memory Protect

Before you record a track or pattern, or edit the musical data, you will need to turn off the memory protect setting in Global mode. (PG p.42)

About MIDI

Track status “status”

You can make settings for this instrument’s sequencer to specify whether it will sound the internal tone generator or an external tone generator.

When Track Status “Status” (3.1: Param1, MIDI..8, MIDI..16) is set to INT, operating this instrument’s keyboard and controllers will sound and control this instrument’s own tone generator.

When “Status” is set to EXT, EX2 or BTH, operating this instrument’s keyboard and controllers will sound and control the external tone generator. (The MIDI channel of the external tone generator must match the “MIDI Channel” of the track that is set to EXT, EX2 or BTH.) With a setting of BTH, both the external tone generator and this instrument’s tone generator will sound and be controlled.

SEQ 3.1:Param1					MIDI:Status			
Drum	Bass	Keyb	Guita	Slow	Guita	Guita	Strin	
INT	INT	INT	INT	EXT	EX2	BTH	INT	
01	02	03	04	05	06	07	08	
T01: Drums				T01	AD20:Standard Kit 1		Ch 01	
MIDI..8 MIDI..16 OSC..8 OSC..16 Fteh..8 Fteh..16								
UTILITY								

If you wish to use the Sequencer mode of the instrument as a 16-track multi-timbral tone generator, select INT or BTH. (PG p.62 “Status”)

Synchronizing the sequencer with an external MIDI device

The record/playback tempo of this instrument’s sequencer can be synchronized to an external MIDI device such as a sequencer or rhythm machine (PG p.239).

Recording on the TRITON Le

The process by which your playing on this instrument's keyboard and controllers is captured on the tracks or patterns of a song as data is called "recording."

Recording a track, and recording a pattern

Recording a track

There are two ways to record to a track: **realtime recording** and **step recording**. You can choose from a further six types of realtime recording.

In addition, you can use **event editing** to modify data that has been recorded or to insert data, and use **track editing** operations such as **Create Control Data** to insert data such as bend, after touch, and control changes.

Recording a pattern

There are two ways to record a pattern: **realtime recording** and **step recording**. For realtime recording, only one recording type (loop) is available.

In addition, you can use **event edit** operations to modify data that has been recorded or to insert data.

The Utility menu command "Get From Track" can be used to take musical data from a desired area of a track, and use it as the musical data for a pattern. Conversely, the Utility menu commands "Put to Track" and "Copy to Track" can be used to place or to copy the musical data of a pattern in a track.

Realtime recording

This is a method of recording in which your playing on the keyboard and your operations of controllers such as the joystick are recorded in realtime.

This method of recording is normally used one track at a time, and is called **single track recording**.

As an alternative, **multitrack recording** allows you to simultaneously record multiple channels of data onto multiple tracks. This is the method you will use when using the RPPR function and the arpeggiator function to record multiple tracks of musical data at once, or when you playback existing sequence data on an external sequencer and record it onto this instrument's sequencer in realtime (see p.74).

• Overwrite

With this method, the musical data previously recorded on a track is overwritten by the newly recorded data. When you perform overwrite recording on a previously-recorded track, its musical data will be replaced by the newly recorded data. Normally you will use this method to record, and then modify the results by using other types of realtime recording or event editing.

- ① Use "Track Select" to select the track that you want to record.
- ② Set the "Recording Mode" to Over Write. (SEQ 1.1: Play/REC, Preference page REC Setup)



- ③ In "Location," specify the location at which you wish to begin recording.
- ④ Press the [REC/WRITE] key, and then press the [START/STOP] key.

If "Metronome Setup" has the default settings, the metronome will sound for a two-measure pre-count, and then recording will begin.

Play the keyboard and move controllers such as the joystick to record your performance.

- ⑤ When you finish playing, press the [START/STOP] key.

Recording will end, and the location will return to the point at which you begin recording.

At this time if you press the [PAUSE] key instead of the [START/STOP] key, recording will pause. When you press the [PAUSE] once again, recording will resume. When you are finished, press the [START/STOP] key to stop recording.

• Overdub

With this method, the newly recorded musical data is added to the existing data.

When you perform overdub recording on a previously-recorded track, the newly recorded data will be added to the previously-recorded data.

It is best to select this method when you wish to add control data, or to record tempo data onto the master track. This lets you record data without erasing the existing data.

- ① Use "Track Select" to select the track that you want to record.
- ② Set the "Recording Mode" to Over Dub. (SEQ 1.1: Play/REC, Preference page REC Setup)



- ③ For the rest of the procedure, refer to steps ③–⑤ of "Overwrite."

• Manual punch-in

While the song is playing, you can press the [REC/WRITE] key or a connected pedal switch at the desired location to start or stop recording.

With this method, the musical data previously on the track is overwritten by the newly recorded data.

- ① Use "Track Select" to select the track that you want to record.

- ② Set the “Recording Mode” to Manual Punch In. (SEQ 1.1: Play/REC, Preference page REC Setup)



- ③ In “Location,” specify a location several measures earlier than the point at which you wish to begin recording.
- ④ Press the [START/STOP] key.
Playback will begin.
- ⑤ At the point at which you wish to begin recording, press the [REC/WRITE] key.
Recording will begin.
Play the keyboard and operate controllers such as the joystick to record your performance.
- ⑥ When you finish recording, press the [REC/WRITE] key.
Recording will end (playback will continue).

note Instead of pressing the [REC/WRITE] key in steps ⑤ and ⑥, you can use a foot switch connected to the ASSIGNABLE SWITCH jack. Set the GLOBAL 1.1: System, Foot page “Foot SW Assign” to Song Punch In/Out (p.113).

- ⑦ Press the [START/STOP] key.
Playback will stop, and you will return to the location that you specified in step ③.

• Auto punch-in

First you must specify the area that will be re-recorded. Then recording will occur automatically at the specified area.
With this method, the musical data previously on the track is overwritten by the newly recorded data.

- ① Use “Track Select” to select the track that you want to record.
- ② Set the “Recording Mode” to Auto Punch In. (SEQ 1.1: Play/REC, Preference page REC Setup)



- ③ In “Auto P Start Meas,” “Auto P End Meas” specify the area that you wish to record.
For example if you specify M005–M008, recording will occur only from measure 5 to measure 8.
- ④ In “Location,” specify a location several measures earlier than the point at which you wish to begin recording.
- ⑤ Press the [REC/WRITE] key, and then press the [START/STOP] key.

When you reach the starting location you specified in step ③, recording will begin. Play the keyboard and operate controllers such as the joystick to record

your performance. When you reach the ending location you specified in step ③, recording will end. (Playback will continue.)

- ⑥ Press the [START/STOP] key.

Playback will stop, and you will return to the location you specified in step ④.

• Loop All Tracks

This method lets you continue recording as you add musical data.
The specified region can be recorded repeatedly.
This is ideal when recording drum phrases, etc.

- ① Use “Track Select” to select the track that you want to record.
- ② Set the “Recording Mode” to Loop All Tracks. (SEQ 1.1: Play/REC, Preference page REC Setup)
If “Multi REC” is checked, it will not be possible to select Loop All Tracks.



- ③ In “Loop Start Meas,” “Loop End Meas” specify the area that you wish to record.
For example if you specify M004–M008, recording will occur repeatedly (as a loop) from measure 4 to measure 8.
- ④ In “Location,” specify a location several measures earlier than the point at which you wish to begin recording.
- ⑤ Press the [REC/WRITE] key, and then press the [START/STOP] key.

Playback will begin. When you reach the starting location you specified in step ③, recording will begin. Play the keyboard and operate controllers such as the joystick to record your performance.

When you reach the ending location you specified in step ③, you will return to the starting location, and continue recording.

The musical data that is loop-recorded will be added to the previously-recorded data.

- ⑥ You can also erase specific data even while you continue loop recording.

If you press the [REC/WRITE] key during loop recording, all musical will be removed from the currently selected track as long as you continue pressing the key.

By checking the “Remove Data” check box you can erase only the specified data. During loop recording, press the note that you wish to delete, and only the data of that note number will be deleted from the keyboard as long as you continue pressing that note.

Similarly, bender data will be deleted as long as you tilt the joystick in the X (horizontal) direction, and after touch data will be deleted as long as you apply pressure to the keyboard.

When you are once again ready to record musical data, **uncheck** the “Remove Data” check box.

⑦ **Press the [START/STOP] key.**

Playback will end, and you will return to the recording start location that you specified in step ④. If Loop All Tracks is selected, normal playback will be looped as well.

• **Multi (multitrack recording)**

Multitrack recording allows you to simultaneously record onto multiple tracks, each with a different channel. This method can be used with overwrite, overdub, manual punch-in, and auto punch-in recording.

Using the arpeggiator to record multiple tracks simultaneously

A multi-track performance using the arpeggiator function can be recorded simultaneously using multi recording (see p.76).

When simultaneously recording multiple tracks using the RPPR function

You can use multitrack recording to simultaneously record the playback of multiple tracks that are being triggered by the RPPR function. For the procedure, refer to “Realtime-recording an RPPR performance” (see p.74).

When simultaneously recording multiple tracks of MIDI data from an external sequencer, etc.

① **Make sure that the TRITON Le’s MIDI IN and the external sequencer’s MIDI OUT are connected by a MIDI cable.**

If they are not connected, turn off the power, make the connection, and then turn the power back on again. (see PG p.231)

② **Set the MIDI Clock (GLOBAL 2.1: MIDI, MIDI page “MIDI Clock”) to External, so that this instrument will synchronize to the MIDI clock of the external sequencer (see PG p.127).**

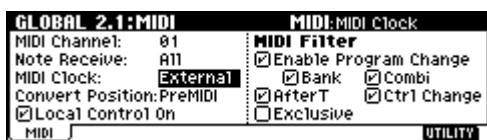

③ **Create a new song, and in the SEQ 1.1: Play/REC, Preference page, check the “Multi REC” check box. Set the “Recording Mode” to Over Write.**

④ **Select the SEQ 1.1: Play/REC, Program page.**

For the tracks that you are not recording, set “PLAY/MUTE/REC” to PLAY or MUTE.

⑤ **In SEQ 3.1: Param1, MIDI page “MIDI Channel,” specify the MIDI channel for each track.**

The specified channel of musical data will be recorded on that track. It is a good idea to set tracks 1–16 to MIDI channels 1–16. (This is the default setting.) Also make sure that “Status” is set either to INT or BTH.

⑥ **Press the [LOCATE] key to set the location to 001:01.000.**

⑦ **Press the [REC/WRITE] key to enter recording-standby mode.**

⑧ **Start the external sequencer.**

The TRITON Le’s sequencer will receive the MIDI Start message transmitted by the external sequencer, and will automatically begin recording.

⑨ **When the song ends, stop the external sequencer.**

This instrument’s sequencer will receive the MIDI Stop message transmitted by the external sequencer, and will automatically stop recording. You can also press the [START/STOP] key on this instrument itself to stop recording.

⑩ **Playback.**

In the GLOBAL 2.1: MIDI page, set “MIDI Clock” to **Internal**.

Set “Tempo Mode” to **Auto**.

When you press the [START/STOP] key, playback will begin.

note If the correct sounds do not play immediately after playback is started, you may be able to solve the problem by using the Utility menu command “Event Edit” (SEQ 5.2: Track Edit) to edit the Program Change data.

Step recording

This is a method of recording where you specify the note timing, note length, and velocity etc. in the LCD screen, and use the keyboard to input the pitches. (see p.65)

Only note-on/off data can be recorded with this method.

Event Edit and Create Control Data

Note data is the only type of data that can be recorded in step recording. However there are ways to record other types of data, aside from the realtime mode. You can use the Event Edit and Create Control Data functions.

Event Edit is intended as a way to edit previously-recorded data, but you can also use it to modify program numbers or insert control changes.

Create Control Data is a function that lets you create and insert controller data that changes smoothly between two specified values over the specified length of time. This is used to input bend, after touch, and control change data etc.

Realtime-recording to a pattern

Here’s how you can use realtime recording to create a pattern. User patterns can be accessed by the RPPR function in the same way as preset patterns, and can be copied to or placed in a song. Playback data from a track can also be copied to a pattern.

▲ Before you begin recording a pattern, turn off the memory protect setting in Global mode (see p.42).

When realtime-recording a pattern, a pattern of the specified number of measures will playback repeatedly, allowing you to continue adding musical data to it.

- ① Create a new song, and load the template song "P02: R&B." (p.63)
- ② Access the SEQ 5.1: RPPR, Pattern page.

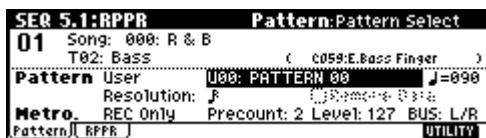

- ③ For "Track Select," select track T02: Bass.
- ④ Set "Pattern Bank" to User, and set "Pattern Select" to U00.
User patterns U00–U99 can be created for each song.
- ⑤ Select the Utility menu command "Pattern Param."

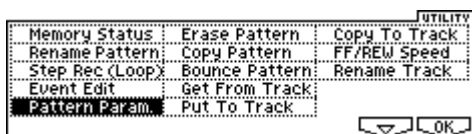

A dialog box will appear.

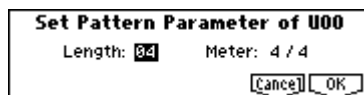

- ⑥ Set the number of measures in the pattern to a "Length" of 04 (four measures), and set "Meter" to a time signature of 4/4. Press the [F8] ("OK") key.
- ⑦ Set the "Resolution." For this example, select ♩ (16th note).
- ⑧ Begin realtime recording.
You can record in the same way as you did when recording tracks with Loop All Tracks. (p.79)
Press the [REC/WRITE] key, and then press the [START/STOP] key.
After the pre-count, pattern recording will begin. Play the keyboard and operate the joystick and other controllers to record your performance. When you reach the end of the pattern, you will return to the beginning of the pattern and continue recording. If you continue recording, the newly recorded data will be added to the previously-recorded data.
- ⑨ If you want to delete specific data while you continue pattern recording, you can press the [REC/WRITE] key or check the "Remove Data" check box.
For details refer to step ⑥ of "Loop All Tracks" (p.79).
- ⑩ Press the [START/STOP] key to stop recording.

If you made a mistake or decide to re-record, press the [START/STOP] key to stop recording, and press the [COMPARE] key.

Using the arpeggiator for pattern recording

If the arpeggiator is set to operate for the track that is selected for "Track Select," you can turn on the [ARP ON/OFF] key and record the performance of the arpeggiator into the pattern.

For details on arpeggiator settings, refer to p.74 and PG p.81.

Control data in pattern recording

To record control data in a pattern, you should restore the control data to its normal value within the pattern. If you fail to restore the normal value, unnecessary control data may remain in a "stuck" position when you place the pattern in a song or use the RPPR function to play the pattern. However, the following control data will be automatically reset to the following values when the song or RPPR function finishes playing the pattern, or when playback is halted.

Controller	Reset value
Modulation 1 (CC#01)	00 (zero)
Modulation 2 (CC#02)	00 (zero)
Expression (CC#11)	127 (max)
Ribbon controller (CC#16)	64 (center)
Damper switch (CC#64)	00 (zero)
Sostenuto switch (CC#66)	00 (zero)
Soft switch (CC#67)	00 (zero)
EG sustain level (CC#70)	64 (center)
Resonance level (CC#71)	64 (center)
EG release time (CC#72)	64 (center)
EG attack time (CC#73)	64 (center)
Low pass filter cutoff (CC#74)	64 (center)
EG decay time (CC#75)	64 (center)
LFO1 speed (CC#76)	64 (center)
LFO1 depth (pitch) (CC#77)	64 (center)
LFO1 delay (CC#78)	64 (center)
Filter EG intensity (CC#79)	64 (center)
SW1 modulation (CC#80)	00 (zero)
SW2 modulation (CC#81)	00 (zero)
Channel after touch	00 (zero)
Pitch bender	00 (zero)

Sampling mode

The separately sold EXB-SMPL option can be installed in the TRITON Le to add high-performance mono/stereo sampling functionality.

Features of EXB-SMPL

- **48 kHz 16 bit linear mono/stereo sampling.**
- **The EXB-SMPL includes a 16 Mbyte 72 pin SIMM sample data (waveform data) memory module.** When this memory is installed in the TRITON Le, you can sample for approximately 2 minutes 54 seconds in monaural, or approximately 1 minute 27 seconds in stereo. By installing 72 pin SIMM modules, you can expand the memory to a **maximum of 64 Mbytes**, which will allow you to record up to four 2 minute 54 second samples in mono (or four 1 minute 27 second samples in stereo), for a maximum total of approximately 11 minutes 39 seconds of sampling time (approximately 5 minutes 49 seconds in stereo). (For details on expansion, refer to PG p.253.)
- A **maximum of 1,000 multisamples and 4,000 samples** can be created.
- In Media mode you can load multisample/sample data from a SmartMedia or SCSI media.
- Korg format or Akai (S1000/3000 samples, mapped multisamples only) format sample data, and AIFF or WAVE format sample data can be loaded. (Once data has been loaded into the TRITON Le, it will all be treated as Korg format sample data.) Sample data created on the TRITON Le can be exported (output) as an AIFF or WAVE format sample file.
- The external audio source that you are sampling can be processed by the **one insertion effect** to apply effects such as a compressor or EQ. The LFO frequency or delay time of the effect can be specified as a BPM value, which is highly effective when sampling phrase loops etc.
- Both **auto sampling** and **manual sampling** can be performed. With auto sampling, recording will begin automatically when the input level exceeds a specified threshold. In either method of sampling, you can make pre-trigger settings.
- The audio input supports both mic and line level signals.
- Data you sampled can be played immediately from the keyboard of the TRITON Le or by pressing the [AUDITION] key. It is also easy to **convert sampled data into a program**, and use it as material for the TRITON Le's HI synthesis system. Multisamples/samples that have been converted into a program can be used in a combination or song.
- The waveform can be viewed in the LCD screen, and edited by a variety of waveform editing commands that include **rate convert** (down-sampling) and reverse playback.

The following commands are also provided.

Time Slice

This automatically detects the attack portions of a kick or snare etc. in a rhythm loop sample (a looped pattern of drums etc.), and divides it into separate rhythm instrument sounds. A pattern corresponding to the divided samples is created automatically, so that you can immediately use the Sequencer mode RPPR function to play the pattern and adjust the tempo without changing the pitch. You can also do things such as adjusting the pitch of only the snare, replacing it with a different sample, or changing the playback timing on the sequencer, in this way creating a new rhythm loop based on the rhythm loop you started with. (Stereo samples are supported.)

Time Stretch

This lets you modify the tempo without changing the pitch of a sample. You can select either **Sustaining** (suitable for sustain-type instruments such as strings or vocals), or **Slice** (suitable for rhythm loops on decay-type instruments such drums). Stereo samples are supported.

Crossfade Loop

An important looping tool that helps smooth out irregularities in long loops which contain complex material. By executing Crossfade Loop, you can eliminate this problem and create natural-sounding loops.

Link (with Crossfade)

This allows you to join two samples into a single sample. You can also crossfade the overlapping portion of the samples at this time, so that the volume changes gradually, producing a natural-sounding transition.

- The **BPM Adjust function** (playback pitch adjust) lets you adjust the playback pitch of each index so that the loop frequency matches the desired BPM value.
- Start, loop start, and end addresses can be specified in units of a single sample. **Loop tune, reverse playback, and loop lock functions** are also supported.
- The **Use Zero function** automatically searches for zero-cross points, making it easy to find the beginning or end of the waveform, or locations that will not produce noise when the sample is played back.
- The **grid function** displays a BPM-based grid on the waveform display, helping you to create loops or make waveform edits that match the desired BPM.
- Each multisample allows you to create up to **128 indices**. Each index consists of a sample assignment, a key zone, an original key, a playback pitch, and settings such as level.
- The "Keyboard & Index" display lets you edit a multisample while viewing the assignments and zones of each sample.

- Sample names and multisample names of up to 16 characters can be assigned. Sample names and multisample names can also be viewed in Media mode (PG p.141 "Translation").

How Sampling mode is organized

In Sampling mode

- An external audio signal from an external audio device or microphone connected to the AUDIO INPUT 1 and 2 jacks is passed through an analog/digital convertor, and recorded (sampled).
- You can edit the waveform and loop settings etc. of sample data that you sampled or that you loaded from a SmartMedia, CD-ROM etc., in Media mode.
- You can assign samples to the keyboard to create a multisample. These samples and multisamples can be easily converted to a program using the Utility menu command "Conv. To Program," and these programs can be used immediately in a combination or a song.

Sampling frequency and bit resolution

As shown in the diagram, sampling reads the level of the analog signal at fixed intervals along the time axis, and stores the levels in memory as digital data.

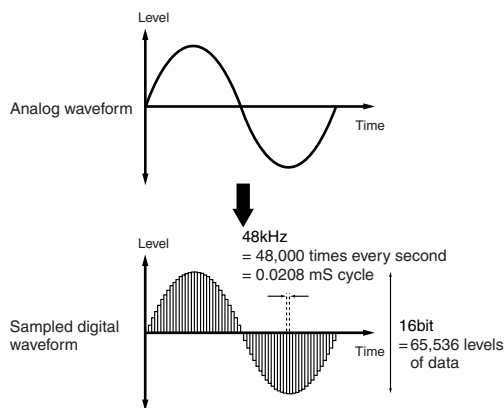

The "fixed intervals" mentioned above are generally expressed as the "sampling frequency." 48 kHz (kilohertz) means that sampling is performed 48,000 times each second, and that the interval is $1 \text{ (second)} / 48,000 \text{ (times)} = \text{approximately } 0.00002083 \text{ (seconds)} = \text{approximately } 0.02083 \text{ mS (millisecond)}$.

The higher the sampling frequency is, the closer to the original analog signal the waveform in memory will be.

Each level is read, and converted into digital data. The accuracy at this time is determined by the bit resolution. This process converts an analog signal with infinite resolution into a digital signal with finite resolution. With 16 bit resolution, each level is indicated in 65,536 steps (the sixteenth power of two). The greater the bit resolution is, the closer to the original analog signal the waveform in memory will be.

48 kHz 16 bit sampling is the same quality as in audio devices such as DAT. A CD uses 44.1 kHz 16 bit sampling, which is a slightly lower sampling frequency.

Samples and Multisamples

Samples

The data that is recorded (sampled) into internal memory or loaded from a file is referred to as a sample or sample file. Samples consist of the actual waveform data, and parameters that specify how the data will be played back, such as Start, Loop Start, and End Address. Samples can be used in multisamples and drum kits.

The TRITON Le can hold a maximum of 4,000 samples in its internal memory.

note The TRITON Le can share a single waveform among multiple samples. This allows you to create multiple samples with different playback addresses from the same waveform without wasting internal memory. For example, suppose that you have waveform data that records a voice saying "One-Two-Three." This single piece of waveform data could be shared by three samples, with

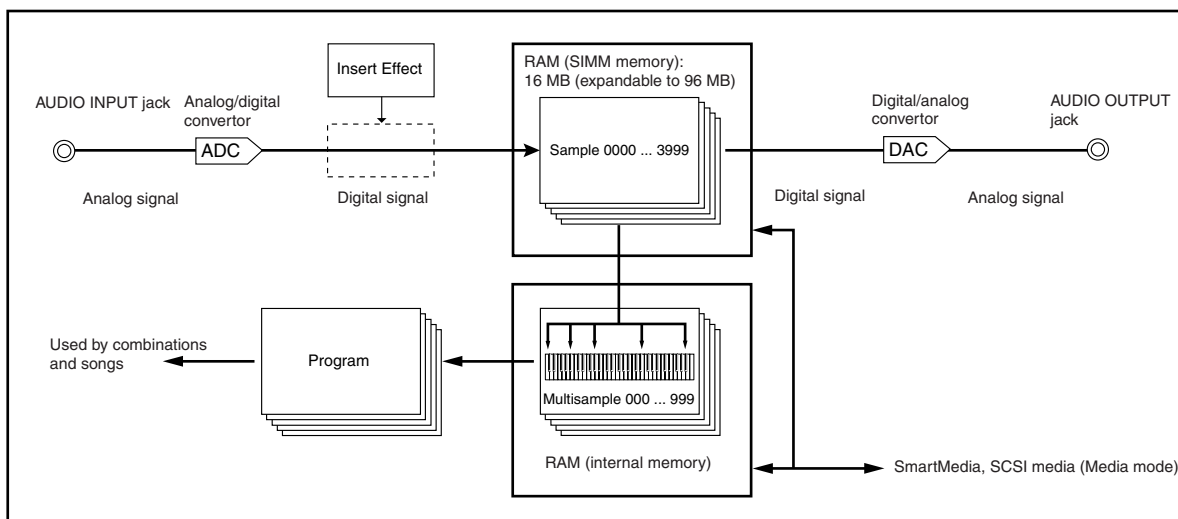

the playback of sample A producing "One-Two-Three," sample B producing "One-Two," and sample C producing "Two-Three." (PG p.80).

Multisamples

A multisample consists of settings that make one or more samples sound in different areas of the keyboard. A multisample consist of between one and 128 "indexes." Each index contains parameters that specify the sample that will playback, the zone for which it will playback, the original pitch key, the playback pitch, and level etc.

Using multisamples

When sampling an instrument that is able to produce a wide range of pitches, such as a piano, recording just one sample and using it (playing it back) over the entire pitch range will not produce a natural-sounding result. By using a multisample you can record separate samples for each pitch range, and assign these samples to their respective pitch ranges to avoid any unnatural sounds during playback. For example, you might record one sample per octave, and assign each of these samples to an index (keyboard area). All of the instrumental sounds in the TRITON Le's internal preset ROM multisamples are constructed in this way.

By assigning multiple samples such as phrase samples or rhythm loops to a multisample and arranging them across the keyboard, you can play multiple samples simultaneously. Since a different phrase could be assigned to each key, you can perform just as though you were using a pad-type sampler. Alternatively, these samples could be assigned at one-octave intervals, and played as phrase variations with different playback pitches.

The TRITON Le can hold a maximum of 1,000 multisamples in its internal memory.

A multisample can be selected as the oscillator for a program, and played as a program. In a combination, they can be combined with preset programs, and used in a multi. They can be used with the arpeggiator to produce interesting results (for example, by using the arpeggiator to automatically play sound effects or spoken samples).

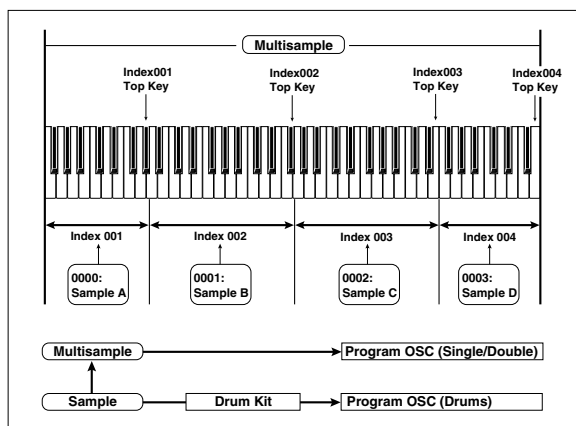

Sampling

note The multisample and sample data in the Sampling mode is not backed up when the power is turned off. If you wish to keep this data, you must save it onto a SmartMedia or external SCSI device before turning off the power.

After the power is first turned on, memory will not contain any multisample or sample data. You must first load previously-saved data before you can playback or edit any sample data.

Preparations for sampling

Connections and settings for a monaural source

When sampling in monaural from a mic, the output of an external audio device or mixer, or an instrumental sound such as guitar or synthesizer, connect the source to the AUDIO INPUT 1 or 2.

note Guitars and other instruments with active pickups can be input directly, but instruments with passive pickups (i.e., without internal preamps) cannot be recorded at an appropriate level, due to impedance mismatching. When connecting such instruments, use a preamp or effect device.

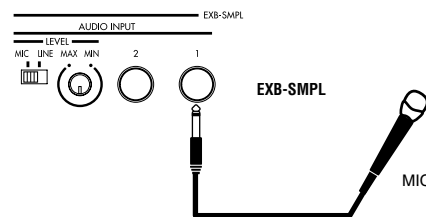

- 1 Connect the mic or external audio device to the AUDIO INPUT 1 jack.
- 2 Set the AUDIO INPUT [MIC/LINE] switch to match the input source. For input sources with a low input level, such as a microphone, select the MIC position. For other sources, select the LINE position.
- 3 The AUDIO INPUT [MIC/LINE] switch affects both the AUDIO INPUT 1 and 2 jacks.
- 3 The [LEVEL] knob will be adjusted later. For now, set it near the center.
- 4 In Sampling mode 1.1: Recording, select the Input/Pref page.



- 5 In "Input 1," set the various parameters that specify how the signal from the AUDIO INPUT jacks will be received by the TRITON Le.
 - "Lvl" adjusts the volume. Normally you will set this to 127.

- “Pan” adjust the panning. For this example set it to L000.
- Set “BUS.” If you wish to use the TRITON Le’s insert effect to process the incoming sound, select IFX here. For this example, select L/R. The input sound will be sampled just as it is.

⚠ Be aware that when you change the setting from Off to L/R or IFX, the volume level in the AUDIO OUTPUT L/MONO and R jacks and in the headphones may rise excessively.

“Input 1” controls the AUDIO INPUT 1 jack, and “Input 2” controls the AUDIO INPUT 2 jack.

The settings above will cause the sound from the AUDIO INPUT 1 jack to be output from the AUDIO OUTPUT L/MONO jack and from the L channel of the headphones.

⑥ Use the [LEVEL] knob to set an appropriate level.

If an overload occurs in the input stage of the TRITON Le, “ADC OVER!” (AD converter overload!) will be displayed above the “Recording Level” slider. Adjust the [LEVEL] knob or the output level of the external audio device just low enough so that the “ADC OVER!” does not appear (i.e., the maximum level that does not cause an overload).

Connections and settings for a stereo source

When sampling in stereo from a stereo mic, the output of an external audio device or mixer, or synthesizer, connect the source to the AUDIO INPUT 1 and 2 jacks.

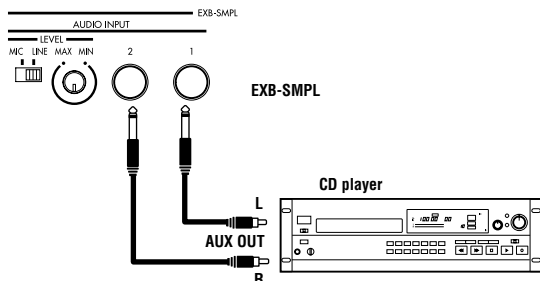

- ① Connect the L source to AUDIO INPUT jack 1, and the R source to jack 2.
- ② Make the settings described in steps ②–④ of “Connections and settings for a monaural source.”
- ③ Set the “Input 1” and “Input 2” parameters to specify how the signal from the AUDIO INPUT jacks will be received by the TRITON Le.
 - “Lvl” adjusts the volume. Set both Input 1 and Input 2 to 127.
 - “Pan” adjust the panning. Set Input 1 to L000, and Input 2 to R127.
 - Set “BUS.” For this example, select L/R for both Input 1 and Input 2.

The settings in the example above will cause the sound from the AUDIO INPUT 1 and 2 jacks to be output in stereo from the AUDIO OUTPUT L/MONO and R jacks and from the headphones. The sound of AUDIO INPUT 1 will be output from the left, and AUDIO INPUT 2 from the right.

- ④ Use the [LEVEL] knob to adjust a suitable input level. (Refer to step ⑥ of “Connections and settings for a monaural source”)

The [LEVEL] knob adjusts both AUDIO INPUT 1 and 2.

Using an insert effect

The TRITON Le’s insert effect can be applied to the sound that is being input from the AUDIO INPUT 1 and 2 jacks, allowing you to record a sample with effects applied. As an example, we will explain the procedure for applying an insert effect to a stereo source and sampling the result.

- ① Make the settings of step ① and ② in “Connections and settings for a stereo source.”
- ② Set the various “Input 1” and “Input 2” parameters.
 - Set “BUS” to IFX for both Input 1 and 2.
 - Set “Lvl” and “Pan” to the same settings as in step ③ of “Connections and settings for a stereo source.” With these settings, the stereo source will be sent to insert effect (IFX).
- ③ Use the [LEVEL] knob to adjust to a suitable input level. (Refer to step ⑥ of “Connections and settings for a monaural source.”)
- ④ Select the 7.1: Insert Effect, Setup page.

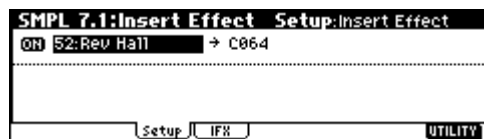

Make settings for “Insert Effect,” “IFX On/Off,” and the “Pan (CC#8)” of the sound after it has passed through the insert effect. (PG p.27, 119)

Examples of settings using the insert effect are given in “Mode (Sample Mode)” (PG p.91).

Manual sampling

There are two methods of sampling: **manual** and **auto**.

In **manual** mode, **sampling** is started by pressing the [START/STOP] key from the recording standby condition (entered by pressing the [REC/WRITE] key once). For the sampling procedure in **auto** mode, refer to “Auto sampling” (p.86).

- ① Select the 1.1: Recording, Recording page.
- ② For “Mode (REC Mode),” select Manual.

This will select manual recording mode.



- ③ Select the 1.1: Recording, Sample page.

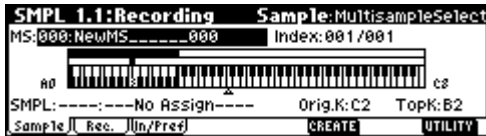

- ④ For “MS (Multisample Select),” select 000: NewMS_000.

Immediately after the power is turned on, 000: NewMS_000 will be created automatically. Use the numeric keys [0]–[9] to input the multisample number that you wish to record, and press the [ENTER] key.

If you select a new number, the Create New Multisample dialog box will appear. Press the [F8] (“OK”) key, and the new multisample will be created.



To specify the name, use the Utility menu command “Rename MS.”

- ⑤ In “SMPL (Sample Select),” select the sample that you wish to record. For this example, select ---: ---No Assign---.

You may sample even in this condition. The sample will be automatically recorded to a vacant sample number.

If you wish to start by specifying the sample number to be sampled, use the [INC]/[DEC] keys or numeric keys [0]–[9] and [ENTER] key to specify the desired number.

A sample will be created when you record. A sample name such as 0000: NewSample_0000 will be assigned automatically. This name can be edited using the Utility menu command “Rename SMPL.”

If you execute sampling when an existing sample such as 0000: NewSample_0000 is selected, the new sample will be sampled to a vacant sample number. You do not need to be concerned with this setting even when you continue recording successive samples.

- ⑥ Select the 1.1: Recording, Recording page.



- ⑦ Set the “Mode (Sample Mode).”

Monaural source: If the “Input1” setting “Pan” is L000, set “Mode (Sample Mode)” to L-Mono. If “Pan” is R127, set “Mode (Sample Mode)” to R-Mono.

Stereo source: Set the “Mode (Sample Mode)” to Stereo.

- ⑧ Press the [REC/WRITE] key.



If an input signal is present, the Recording Level [dB] meter will move according to the “Pan” setting in “Input1” and “Input2.” This is the recording-standby condition.

In the case of “Connections and settings for a monaural source,” the L meter will move. In the case of “Connections and settings for a stereo source,” the L and R meters will move.

Use the “Recording Level” slider to adjust the level. For this example, set the slider to the 0.0 setting (PG p.92).

- ⑨ At the moment that you wish to begin sampling, press the [START/STOP] key.

Sampling will begin.

- ⑩ Sampling will stop when you press the [START/STOP] key.

- ▲ Sampling will stop automatically when the remaining amount of memory reaches zero.

- ⑪ Either press the [AUDITION] key, or press the C2 key.

The sample you recorded will play back.

If you wish to continue recording samples, repeat steps ⑦–⑩.

Auto sampling

With **auto mode**, sampling will begin when the input signal exceeds the specified threshold level.

- ① Select the 1.1: Recording, Recording page.



- ② For “Mode (REC Mode),” select Auto.

This will select auto recording mode.

- ③ Set the “Threshold.”

When the input signal exceeds the “Threshold” level, sampling will begin automatically. The black triangles at both sides of the Recording Level [dB] meter display will indicate the specified level.

note When you use auto sampling, the attack portion of the sampled input sound may be lost, depending on the “Threshold” setting. If this occurs, you can use “Pre Trigger” to sample the sound that occurs before sampling actually begins. Normally you will set this to 0, and use it only when necessary.

- ④ Select the 1.1: Recording, Sample page.

- ⑤ Select the “MS (Multisample Select).”

(☞ “Manual sampling” step ④)

- ⑥ Select the sample in “SMPL (Sample Select)” that you wish to record.

(☞ “Manual sampling” step ⑤)

- ⑦ Select the 1.1: Recording, Recording page.

- ⑧ Set the “Mode (Sample Mode).”

(☞ “Manual sampling” ⑥ ⑦)

- ⑨ Press the [REC/WRITE] key.

- ⑩ Press the [START/STOP] key.

When the input signal exceeds the “Threshold” level, sampling will begin automatically.

- ⑪ Sampling will stop when you press the [START/STOP] key.

- ▲ Sampling will end automatically if the remaining amount of memory reaches zero.

- ⑫ Either press the [AUDITION] key, or press the C2 key.

The sample you recorded will play back.

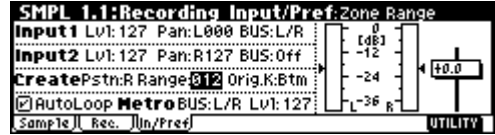

Immediately after the power is turned on, “Psth (Position)” will be R (Right), “Range (Zone Range)” will be 012 (Keys), and “Orig.K (Original Key Position)” will be Btm (Bottom), so that indexes will be created as shown below.

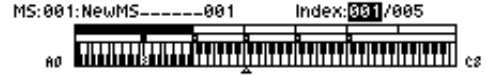

note If you set “Range (Zone Range)” to 1(Key), an index will be created for each note of the keyboard. It is convenient to use 1(Key) when you wish to sample numerous takes in succession, such as when recording phrases or rhythm loops.

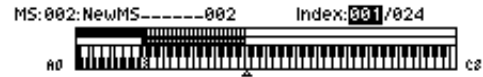

- ④ Select “Index.”

“Index” can also be selected by holding down the [ENTER] key and playing a note on keyboard. For this example, select 001.

- ⑤ Assign a sample to the “Index.”

If sampling RAM memory already contains samples, use “SMPL” (Sample Select) to select the sample and assign it.

If you want to record a new sample, you can sample it now.

The sample you record will be automatically assigned to the index you selected in step ④. (☞ For the sampling procedure, refer to “Manual sampling” or “Auto sampling.”)

The assigned sample will sound when you play the keyboard in the range of the index to which the sample is assigned, or when you press the [AUDITION] key.

- ⑥ Repeat steps ④ and ⑤ to assign a sample to each index.

note The number and order of the indexes in a multi-sample, the range of each index, and the original key position can be freely changed later if desired. (☞ p.90 “Multisample editing”)

Creating multisample indexes and sampling

Here’s how to create indexes for a multisample, and how to assign a sample to each index.

- ① Select the 1.1: Recording, Sample page.

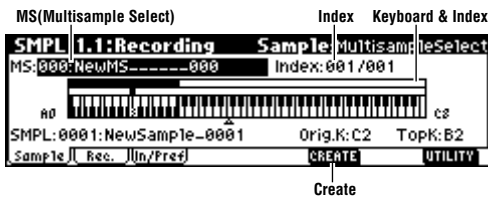

- ② Select “MS (Multisample Select),” and create a multisample. (Refer to “Manual sampling” ④)

- ③ Press the [F6] (“CREATE”) key to create an index.

Immediately after the power is turned on, the “Index” will be indicated as 001/001. This means that there is only one index. The range that is highlighted in the keyboard & Index is the range of the selected index.

Press the [F6] (“CREATE”) key several times. Each time you press it, an index will be created. The keyboard display will indicate the zone and original key location of each index. The highlighted area is the currently selected index.

note The index that is created when you press the [F6] (“CREATE”) key will be created according to the 1.1: Recording, Input/Pref page Create settings. (These settings can also be made in 4.1: Multisample, Pref. page Create Zone Preference. ☞ PG p.93, 117)

Creating multiple samples

In the example procedure described above, several indexes were created (by pressing the [F6] (“CREATE”) key several times), and then samples were assigned to each “Index.”

As an alternative method, it is also possible to create one index, sample into it, and then repeat these two steps.

- ① Press the [F6] (“CREATE”) key once to create an index.

- ② Record a sample.

The recorded sample will automatically be assigned to the index you created in step ①.

③ Repeat steps ① and ②.

This is an efficient way to record multiple samples. (p.35)

Loop settings

With the default settings after the power is turned on, the sounds you sample will automatically be looped (1.1: Recording, Input/Pref page "AutoLoop (Auto Loop On)" On)

To edit the loop and other playback address settings for the sample, use the 3.1: Loop Edit, Edit2 page.

① Select the sample for which you wish to make loop settings.

To select the sample, use the "SMPL (Sample Select)" or "Index" parameters of 3.1: Loop Edit, Edit 1 page or of the 1.1: Recording, Sample page. (p.87)

⚠ If you use "SMPL (Sample Select)" to select the sample, be aware that the assignment to the index will also change.

② In the 3.1: Loop Edit, Edit1 page, use the "Lp (Loop)" check box to turn loop playback on/off for the sample.

Looping will be turned on if the box is checked. This will operate between the addresses you specify in step ④.

Loop On: S→E→LpS→E→ (LpS→E is repeated)

Loop Off: S→E

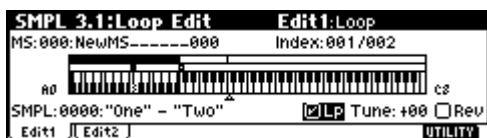

③ Select the 3.1: Loop Edit, Edit2 page.



The waveform data of the currently selected sample will be displayed. To hear this data, play a key in the keyboard range that is highlighted in "Keyboard & Index." Alternatively, you can press the [AUDITION] key to play back the data.

note In the case of a sample that was sampled with a "Mode (Sample Mode)" setting of Stereo, the waveform display will alternate between L and R each time you press the [F3] ("L/R") key. At this time, the upper right of the display will indicate [L] or [R].

④ Specify the start address in "S (Start)," the loop start address in "LpS (Loop Start)," and the end address in "E (End)."

Select "S (Start)" (highlighted), and use the [VALUE] dial or other VALUE controllers to modify the value. The corresponding vertical line will move. Set "LpS (Loop Start)" and "E (End)" in the same way. In the example shown below, "S (Start)" is set immediately before the first waveform, "LpS (Loop Start)" is set immediately before the second waveform, and "E (End)" is set as desired.

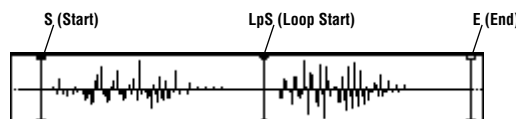

note By using the ZOOM ([F4] key-[F7] key) you can change the range that is displayed. When "S (Start)" is highlighted, zoom will be performed from the start address (p.99).

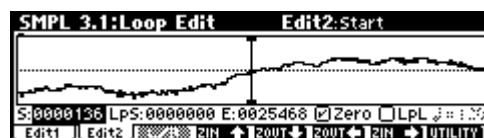

note If the "Zero (Use Zero)" check box is checked, only those addresses where the waveform data crosses the zero level will be found automatically when searching, and can be set. This lets you easily make address settings where noise is less likely to occur when looping.

⑤ If necessary, use the Utility menu command "Truncate" to delete unwanted data that falls outside the start (or loop start) and end addresses.

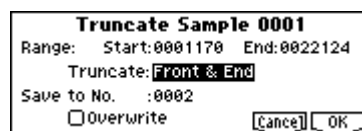

Set the parameters, and press the [F8] ("OK") key to execute the operation. (p.100)

⚠ For cautions on the "Save to No." and "Overwrite" check boxes, refer to "About "Overwrite"" (p.99).

The grid display

The Utility menu command "Grid" overlays the waveform display with a grid based on the BPM tempo value. This makes it easy to make loop settings that are synchronized to the tempo.

note In the same way, the grid display can also be used in 2.1: Sample Edit, Edit2 page. The grid can help you to edit the waveform in synchronization with the tempo.

① Select the Utility menu command "Grid".

The following dialog box will appear.

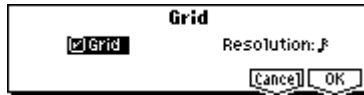

Check “Grid,” set “Resolution” as desired, and press the [F8] (“OK”) key. The dotted grid lines will appear.

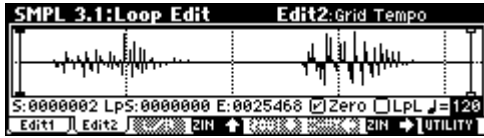

- ② Set “♩ (Grid Tempo)” to the desired BPM tempo value.
- ③ Set the end address so that it coincides with a dotted line of the grid.

This will cause the loop interval to be the same length as the BPM value.

The grid display will be based at “LpS (Loop Start)” if looping is on. If looping is off, the grid will be based at “S (Start).”

- ④ To hide the grid display, select the Utility menu command “Grid,” uncheck “Grid,” and press the [F8] (“OK”) key.
- ⚠ The grid is displayed according to the playback pitch of the base key (the key shown in gray in the “Keyboard & Index” area). You can select the base key by holding down the [ENTER] key and playing a note on the keyboard.

Sample (waveform data) editing

Editing the waveform data of the sample is done in 2.1: Sample Edit. You can use commands such as cut, copy, and normalize to edit the waveform data.

- ① Select the sample that you wish to edit.

Use “SMPL (Sample Select)” or “Index” in the 2.1: Sample Edit, Edit 1 page or the 1.1: Recording, Sample page to select the sample. (≡p.87)

⚠ If you use “SMPL (Sample Select)” to select the sample, be aware that the index assignment will also change.

- ② Select the 2.1: Sample Edit, Edit2 page.



The waveform data of the currently selected sample will be displayed.

note The waveform display of a sample that was sampled with a “Mode (Sample Mode)” setting of Stereo can be switched between the L and R waveforms by pressing the [F3] (“L/R”) key. When you do so, [L] or [R] will be displayed alternately in the upper right.

- ③ Use “S (EditRangeStart)” and “E (EditRangeEnd)” to specify the range that you wish to edit.

The selected range will be highlighted.



If you wish to hear the sound of the selected range, press the [START/STOP] key. The selected range will play back at the pitch of the base key (the key shown in gray on the keyboard display). You can select the base key by holding down the [ENTER] key and playing a note on keyboard.

When you play a key to which the sample is assigned (the highlighted range of the keyboard displayed in “Keyboard & Index”), and the sample will be played back according to its loop settings.

note The procedure for using the ZOOM and “Zero (Use Zero)” check boxes is the same as for 3.1: Loop Edit.

- ④ From the list of Utility menu, select the desired editing command. Make the appropriate settings in the dialog box, and press the [F8] (“OK”) key to execute.

For details on each command (≡PG p.99).

A note on saving samples

In the dialog boxes of some Utility menu, there is a “Save to No.” setting that lets you specify the sample number to which the edited sample will be saved. At this time, a vacant sample number will be selected automatically, so you will change the setting only if you want to specify the save destination number.

If you check “Overwrite” in the dialog box of the command, the data prior to editing will be deleted, and will be overwritten by the edited data. Normally, you will execute the Write operation without checking this, so that the unedited data is preserved. When you are completely finished with your editing, you can use the Utility menu command “Delete SMPL” to delete unneeded samples.

- ▲ In Sampling mode, there is no Compare function that lets you compare the data before and after editing.
 - If you wish to preserve the unedited state of the multisample or sample, use “Copy SMPL” or “Copy MS” (PG p.94, 95) to copy the multisample or sample before you begin editing it.
 - For some Utility menu commands in 2.1: Sample Edit or 3.1: Loop Edit, you can execute without checking the “Overwrite” setting in the dialog box, so that the sample data previous to editing will be preserved.
-
-

Multisample editing

Editing a multisample is accomplished with a number of operations i.e. creating indexes for the multisample and assigning a sample to each index, editing operations such as deleting, copying, and inserting indexes, and detailed settings such as sample level and pitch for each index.

Multisample editing is performed in 4.1: Multisample.

note Basic settings such as creating indexes and assigning samples can also be made in the 1.1: Recording, Sample page.

.....

Editing the indices

To change the number or order of the indexes, use the INSERT, CUT, COPY, and CREATE.

- ① Select 4.1: Multisample.

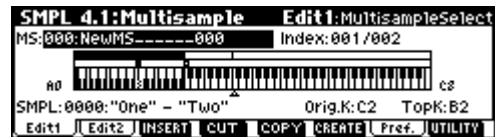

- ② Use “MS (Multisample Select)” to select the multisample that you wish to edit.
- ③ Select the “Index.”
- ④ Press the keys corresponding to the following function buttons to edit the multisample by changing the number or order of the indexes.

To delete the selected index, press the “CUT.” The “INSERT” is used in conjunction with the Cut and “Copy.” The contents of the index that was Cut or Copied will be inserted. The “CREATE” has the same function as the “CREATE” in 1.1 Recording, Sample (p.87 “Creating multisample indexes and sampling”).

.....

Modifying the settings of an index

- ① Make the settings described in steps ①–③ of “Editing the indices.”
- ② Set parameters for the selected index. (PG p.116)
- Changing the Edit1 page “Top K (Top Key)” will change the upper limit of the zone. Simultaneously, the lower limit of the next-numbered index will also change.

- If you check “Constant Pitch” in the Edit2 page, playing any note within the zone of an index will always sound the original pitch.
- Edit2 page “Pitch” adjusts the sample pitch for each index. You can use the Utility menu command “Pitch BPM Adj.” to set the loop interval to a desired BPM value (see PG p.117).



Converting a multisample to a program

The Utility menu command “Conv. To Prog” can be selected and executed in the various pages of 1.1: Recording, in 2.1: Sample Edit, in Edit 1 of 3.1: Loop Edit, in the various pages of 4.1: Multisample, and in 5.2: Ctrl Setup. When you execute this utility, the state of the currently selected multisample will be converted into a program.

In Program mode you can make filter, amp and effect settings etc., and play the sample as a program. The resulting program can be used in a combination or multi.

For details on using the Utility menu command “Conv. To Prog,” refer to p.37 and PG p.97.

Using samples in a drum kit

A sample you created in Sampling mode can be used as one of the instruments in a drum kit. In the GLOBAL 5.1: DKit, High Sample page and Low Sample page, set “Drumsample Bank” to RAM, and use “Drumsample” to select the sample that you created.

Using Time Slice to divide a sample, and playing it in Sequencer mode

Time Slice is a function that detects the attack of the kick or snare etc. in a rhythm loop sample (a sample consisting of a looped pattern of drums etc.), and automatically divides it into separate instrumental sounds. Each of the divided instrumental sounds is made into a sample of its own, and then automatically expanded into a multisample and program. Pattern playback data for the Sequencer mode using the divided samples is also created automatically.

The time-slices sample can be used in the following ways by the song of Sequencer mode.

- Multiple rhythm loop samples of differing tempo can be matched to the same tempo without changing their pitch.
- You can change the tempo in realtime without affecting the pitch.

As an example, we will describe how a rhythm loop sample can be time-sliced in Sampling mode, and then how the rhythm loop sample can be played in Sequencer mode.

You will need to provide rhythm loop samples of drums etc. You can either record these on the TRITON Le, or load them in Media mode. Initially, you should try this using a one-measure pattern in 4/4 time with a fairly simple beat, and record the pattern as a monaural rhythm loop sample.

For this example, we will use a 120 BPM rhythm loop sample.

- ① Select “SMPL (Sample Select)” 120 BPM rhythm loop sample.

note Play back the sample, and verify that the beats that you want to loop are played cleanly. If they are not played cleanly, make the appropriate settings for the start address “S (Start)” and end address “E (End),” and execute the Utility menu command “Truncate” (see p.39, 88).

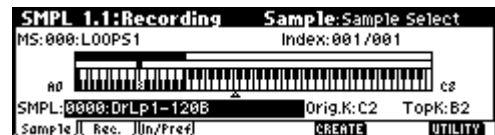

- ② Access the SMPL 3.1: Loop Edit, Edit 2 page.



- ③ Select and execute the Utility menu command “Time Slice.”

Press the [F8] (“UTILITY”) key to access the Utility menu, and press the [F7] key to select “Time Slice.”

Press the [F8] (“OK”) key. The Set Sample Tempo dialog box will appear.

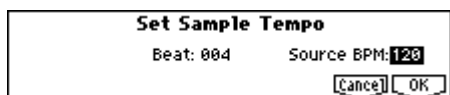

- ④ Specify the number of quarter-note beats in the sample, and its tempo.

If you know the BPM, set “Source BPM.”

If you do not know the BPM, set “Beat” and the BPM will be calculated automatically. Since in this example we do know the beat, set “Source BPM” to 120.

- ⑤ Press the [F8] (“OK”) key.

The sample will automatically be sliced, and a dialog box will appear.

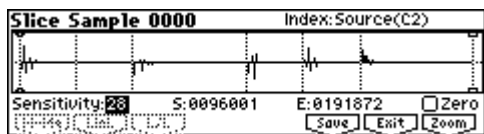

When you play the keyboard, C2 will play the original sample (Source), and D2 and subsequent keys will play the divided sample. You can change “Index” and press the [AUDITION] key to play the sample that is selected by “Index.”

While listening to each divided sample, adjust “Sensitivity” so that each drum strike or other rhythm instrument sound is divided into its own sample. In some cases, it may not be possible to slice the sample cleanly even if you adjust “Sensitivity.” If the attack of the next sound is included in the end of the preceding sample, or if one sample contains two notes, you will need to edit the samples. (PG p.109)

- ⑥ Press the [F6] (“Save”) key.

The save dialog box will appear.



Here you can save the time-sliced sample and the automatically-created multisample. You can set the “With” items to specify the save destination for the program that uses the samples and multisample, and the pattern data for the rhythm loop sample used by the Sequencer mode.

For this example, set the “With” items as shown in the illustration. (Default setting)

Set “Program,” “Seq.Event” to On (checked)

Program: D064

Song: 000, Track: T01

- ⑦ Press the [F8] (“Save”) key to execute the save operation, and you will return to the dialog box of step ⑤.
- ⑧ Press the [F7] (“Exit”) key to return to the screen of step ②.

- ⑨ Press the [SEQ] key to enter Sequencer mode, and set “Song Select” to 000.



The following song data that you specified in steps ⑥–⑧ will be automatically set/created.

- 1.1: Play/REC, Play/REC
Song: 000, Tempo: 120
- 1.1: Play/REC, Prog..8
Track01 Program: D064
- 1.2: Loop, Track PlayLoop
Loop On: On, Loop Start Meas: 1, Loop End Meas: 1
- 5.2: Track Edit, Track01: playback data (D2–)

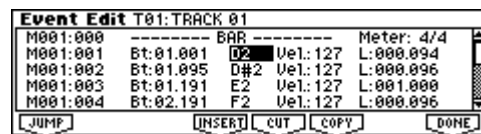

- ⑩ Press the [START/STOP] key to start playback.

Try setting “♩ (Tempo)” to (for example) 100. Notice that the pitch does not change even if you change the playback tempo.

note If the beat of the rhythm loop sample is not reproduced correctly or if noise becomes obtrusive when you change the tempo, the problem is that the slice settings in step ⑤ were not made optimally. The quality of the result when the playback tempo is modified is significantly affected by how cleanly each individual rhythm instrument was divided. Go back to step ⑤ and adjust the separation of each sample.

note In some cases the results may not sound natural. For example, regions of silence between samples may become apparent when you play back at a slower tempo, or noise may occur between samples when the tempo is speeded up. To avoid such problems, set **Stretch** “New BPM” or “Ratio” in step ⑥ to the desired tempo, and execute Time Stretch to adjust the length of each sample. (PG p.110 ⑨)

Global mode

In Global mode you can make settings that affect the entire TRITON Le, such as user scales, category names, drum kits, and user arpeggio patterns (see PG p.121).

This chapter will describe the procedure for editing a drum kit. For the procedure of editing an user arpeggio pattern, refer to "Arpeggiator settings" (see p.99). For details on the parameters of other pages (see p.113).

- ▲ When you play the keyboard in Global mode, the TRITON Le will sound as in the previous mode in which you were previously. Be aware that if you moved from Sampling mode (if the separately sold EXB-SMPL option is installed) to Global mode in a state where the sampling memory contained no data (such as immediately after the power is turned on), playing the keyboard will not produce sound.
- ▲ When you move from Sequencer to Global mode, playing the keyboard will sound the program or arpeggiator that corresponds to the global MIDI channel (set in GLOBAL 2.1).
- ▲ The settings that you edit in Global mode are preserved as long as the power remains on, but will be lost if not written to memory before the power is turned off. The data handled in Global mode can be classified into three types: user drum kit settings (GLOBAL 5.1), user arpeggio pattern settings (GLOBAL 6.1), and all other global settings (GLOBAL 1.1–4.1). Each of these three types of data can be written into the memory area. In Media mode, this data can also be saved on external media such as a SmartMedia (see p.44).
- ▲ Global mode does not provide a Compare function that lets you make before-and-after comparisons of your editing. Before editing user drum kits, or user arpeggio patterns, you may wish to use "Copy Drum Kit" or "Copy Arpeggio Pattern" to copy the user drum kit or user arpeggio pattern to an unused number.

Creating a drum kit

About drum kits

A drum kit consists of drum samples (PCM drum waveform data) assigned to each note, with individual adjustments for pitch and level, etc.

This instrument has 24 drum kit memory areas. With the factory settings, 00 (INT)–15 (INT) contain pre-loaded drum kits suitable for a variety of musical styles. 24 (GM)–32 (GM) contain nine different preset drum kits that are compatible with the GM2 sound map. (see For details on the factory-set drum kits, refer

to "VNL".)

In GLOBAL 5.1: DKit you can edit these drum kits to create your own original drum kits. You can also create original drum kits using sample waveforms that you sampled in Sampling mode (if the separately sold EXB-SMPL option is installed) or loaded into internal memory in Media mode.

A drum kit that you edited or created can be written into one of the user drum kit memory areas 00 (INT)–23 (User). In Media mode, drum kits can also be saved to SmartMedia or other external media.

Multisample programs and drum kit programs

There are two types of programs: those whose oscillator uses a **multisample**, and those whose oscillator uses a **drum kit**.

This selection is made by the PROG 2.1 Ed-Basic, Prog Basic page "Mode (Oscillator Mode)" setting. To use a **multisample** for the program, set "Mode (Oscillator Mode)" to **Single** or **Double**. To use a drum kit, set "Mode (Oscillator Mode)" to **Drums**.

About program parameters

Just as the character and effect processing of a melodic instrument such as piano, organ, trumpet, and strings is fundamentally different from that of percussion instruments such as drums or timpani, the program parameter structure of a multisample program ("Mode (Oscillator Mode)" to **Single** or **Double**) is fundamentally different from that of a drum kit program ("Mode (Oscillator Mode)" to **Drums**).

The program parameters of a multisample specify filter and amp settings etc. appropriate for a multisample. For this reason, it is difficult to change such a program for use with a drum kit. Thus if you wish to edit a drum kit, you should first use Program mode to select a program that uses a drum kit ("Mode (Oscillator Mode)" = **Drums**), and then move to the GLOBAL 5.1: DKit page.

Editing a drum kit

Before editing a drum kit, uncheck the Memory Protect (p.42).

① In **PROG 1.1: Play**, select the program that you wish to use while editing the drum kit.

Select a drum kit program from the preload programs etc. If the drum kit that you will be editing is already being used by a program, select that program. (In the separate “VNL,” programs that use a drum kit are marked by a @ symbol.)

Set “Octave” (PROG 2.1–2) to +0 [8]. With a setting other than +0 [8], the relationship between the keys and the sounds will be incorrect.

The effects will sound using the settings of the last-selected program.

When you edit a drum kit, all programs that use that drum kit will be affected.

② Access the **High Sample** page of **GLOBAL 5.1: DKit**.

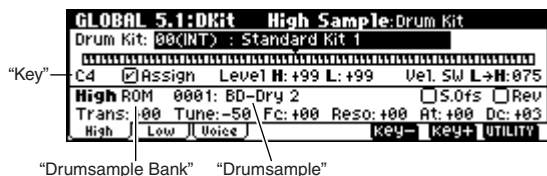

③ In “**Drum Kit**,” select the drum kit that you wish to edit.

If necessary, use the Utility “Copy Drum Kit” to copy settings from a preload drum kit or a GM drum kit.

GM drum kits **24 (GM) – 32 (GM)** cannot be selected here. (It is not possible to edit or write a GM drum kit.) If you wish to modify the settings of one of the drum kits **24 (GM) – 32 (GM)**, you can use “Copy Drum Kit” to copy it to **00 (INT) – 23 (User)**, and then edit the copy.

④ Use “**Key**” to select the note number that you wish to edit.

The drum sample parameters for the selected note number will be displayed in the High Sample, Low Sample, and Voice/Mix pages. In addition to using the VALUE controllers, you can also use the following methods to select the note number.

- Hold down the [ENTER] key and play a key on the keyboard to input that note number.
- Use the [F6] (“Key-”) and [F7] (“Key+”) keys to increment or decrement the note numbers.

⑤ Use “**Assign**” to specify whether a drum sample will be assigned to the note number.

If this is **checked**, a drum sample will be assigned to that note number. Normally you will check this. If this is **not checked**, no drum sample will be assigned to that note number. That note number will sound the drum sample assigned at its right, but a semitone lower. Use this setting when you

want only to change the pitch, such as with tom or cymbal sounds.

⑥ Use “**Drumsample Bank**” and “**Drumsample**” to select the drum sample that will be assigned to the note number.

Set the High Drumsample in the High Sample page, and the Low Drumsample in the Low Sample page. If you specify a Low Drumsample, use “Vel.SW L→H” to specify how velocity will switch between the High Drumsample and the Low Drumsample.

Set “**Drumsample Bank**” to **ROM** if you want to select ROM samples. Set “**Drumsample Bank**” to **RAM** if you want to select samples that were recorded in Sampling mode or loaded in Media mode using the EXB-SMPL option.

About ROM drumsamples

This instrument contains 413 drumsamples in its internal ROM memory.

You can use the Utility “Select by Category” to select ROM drum samples from fifteen categories.

For the drumsample names, refer to the separate “VNL.”

⑦ Use “**Vel. SW L→H**” to specify how velocity will switch between drumsamples.

The drumsample that sounds when you perform will depend on the velocity (keyboard playing strength) of the incoming note. This is called **velocity drumsample switching**.

If you set this to **001**, only the High Drumsample will sound.

This is the same type of function as the Velocity Multisample Switching in a program. (p.49 “High Multisample and Low Multisample”)

⑧ Set the parameters of the drumsamples that you assigned.

Set the High Drumsample parameters in the High Sample page, and the Low Drumsample parameters in the Low Sample page.

You can set parameters such as volume level (“Level”), pitch (“Trans,” “Tune”), and tone (“Fc,” “Reso”). (For details on each parameter, refer to PG p.132.)

⑨ As necessary, repeat steps ④–⑧ to set drumsample parameters for each note number.

If you wish to use the settings of another “KEY,” select the Utility “Copy Key Setup”.

⑩ Select the **Voice/Mixer** page in **GLOBAL 5.1: DKit**.

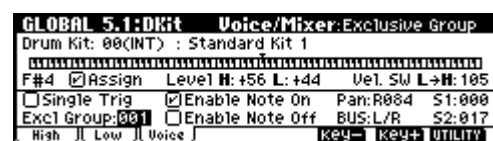

⑪ **Set the “Excl Group (Exclusive Group).”**

The “Excl Group (Exclusive Group)” setting is used when you wish to group drumsamples of the same type.

For example if the note number to which a open hi-hat and a closed hi-hat drumsample are assigned are set to the same exclusive group number, they will be grouped so that the open hi-hat and closed hi-hat can not be sounded simultaneously, ensuring that the hi-hat performance will sound natural.

⑫ **Use “BUS” to specify the output routing.**

Set this when you wish to send the output of the drumsample assigned to each note number to its own insert effect or AUDIO OUTPUT (INDIVIDUAL) jack 1–2.

For example you can specify **IFX** for snare-type sounds, and **L/R** for the other sounds. If you want to send only a specific drum sample to AUDIO OUTPUT (INDIVIDUAL) 1 and/or 2, select **1**, **2**, or **1/2**. These settings are valid if “Use DKit Setting” (PROG 7.1: Ed-InsertFX, BUS page) is **checked** for the program that uses this drum kit (☞PG p.26, 156).

⑬ **Use “Pan” to specify the stereo output position.**

The setting you make here is valid if the “Use DKit Setting” is **checked** (PROG 5.1: Ed-Amp1, Level/Pan page) for the program that uses this drum kit.

⑭ **Use “S1 (Send1(MFX1))” and “S2 (Send2(MFX2))” to set the send levels to the master effects.**

The settings you make here are valid if the “Use DKit Setting” is **checked** (PROG 7.1: Ed-InsertFX, BUS page) for the program that uses this drum kit.

⑮ **Use the Utility “Write Drum Kits” to save the data.**

If you wish to change the name of the drum kit before you save it, use the Utility “Rename Drum Kit” (☞p.43).

If you turn off the power before writing the data into memory, your edits will be lost (☞p.44 “Memory in Global mode”).

Media mode

How Media mode is organized

In Media mode you can use SmartMedia or a connected external SCSI device (if the separately sold EXB-SMPL is installed) to save or load various types of data. You can also make settings related to saving and loading functionality.

For details on connecting an external SCSI device and setting the SCSI ID, refer to the manual included with the EXB-SMPL.

.....

Media that can be used

SmartMedia™

SmartMedia is not included. It must be purchased separately.

The TRITON Le supports SmartMedia with a power supply voltage of 3.3V and capacities of 4 M–128 Mbytes, and SmartMedia with ID.

* SmartMedia™ is a registered trademark of the Toshiba Corporation.

External SCSI storage media

If the EXB-SMPL option (sold separately) is installed, the TRITON Le can save data on external SCSI media (maximum 4 GB) such as a hard disk, Zip, Jaz, ORB, or MO drive.

When the EXB-SMPL option is installed, an external SCSI device of up to 4 GB can be formatted.

note When you insert media for the first time after turning on the power, or after changing disks, you must press a function key etc. to make the TRITON Le detect the media. When the disk (or other media) is recognized, media information will appear in the LCD screen.

note If more than one volume of media is currently recognized, select “Media” and use the [INC]/[DEC] keys to switch between media.

The TRITON Le cannot format media with a format of other than 512 bytes/block (such as 640 MB, 1.3 GB MO disks etc.).

Formatting media

SmartMedia or external SCSI media (via the EXB-SMPL option) must be formatted.

Newly purchased media or media that has been used by another device cannot be used immediately on the TRITON Le. It must first be formatted for use on the TRITON Le.

The TRITON Le supports MS-DOS format. For the formatting procedure, refer to “Format” (PG p.152).

Media must be formatted. SmartMedia or external SCSI media that was formatted on a device other than the TRITON Le may not be recognized correctly.

It is not possible to format media of other than 512 bytes per block (e.g., 640 Mbyte or 1.3 Gbyte MO disks).

Caution when handling SmartMedia

Handling SmartMedia

- Do not fold or bend the SmartMedia card, or subject it to strong physical shock or high temperatures.
- Never transport the TRITON Le with SmartMedia left in the slot. Vibration may scratch the SmartMedia, making it unusable.
- Do not touch the contacts of the SmartMedia. Doing so may cause static electricity to damage the card. After use, keep the card in its static-resistant case.
- Never remove the SmartMedia from the slot while load, save, or format operations are being performed in Media mode.

SmartMedia write protect

If you want to prevent accidental erasure or overwriting of the data saved on SmartMedia, affix a write protect sticker as shown below.

If you once again want to save edited data on the SmartMedia, remove the sticker.

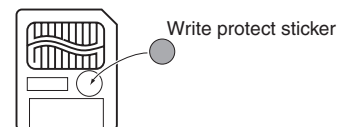

Inserting SmartMedia

Insert the SmartMedia into the slot so that the contacts are facing upward.

Insert the media gently, and straight into the slot.

Push the media in until it no longer protrudes from the rear panel.

Pressing the media with excessive force will cause malfunctions.

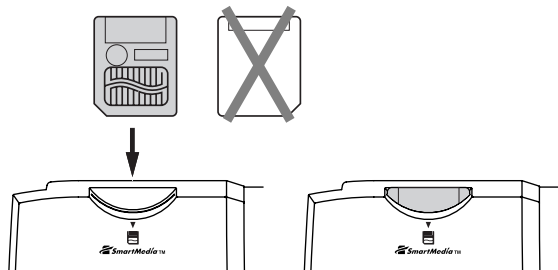

Removing SmartMedia

Pull the media out of the slot without using excessive force.

If you are unable to remove the media, do not use force. Contact your Korg distributor for help.

Loading data

Types of data that can be loaded

The data that can be loaded from external media (e.g., SmartMedia) is shown in the diagram below. (For details on each type of data, refer to PG p.139)

If the EXB-SMPL option is installed, data can also be loaded from media such as a hard disk or CD-ROM.

Data loading procedure

Loading Programs, Combinations, Drum kits, User arpeggio patterns, and Global settings (loading a .PCG file)

As an example, here's how to load a .PCG file. A .PCG file contains programs, combinations, drum kits, user arpeggiator patterns, and global settings (see diagram below).

Select this if you have used "Save All" or "Save PCG" to save your own original programs and combinations, and want to reload this data.

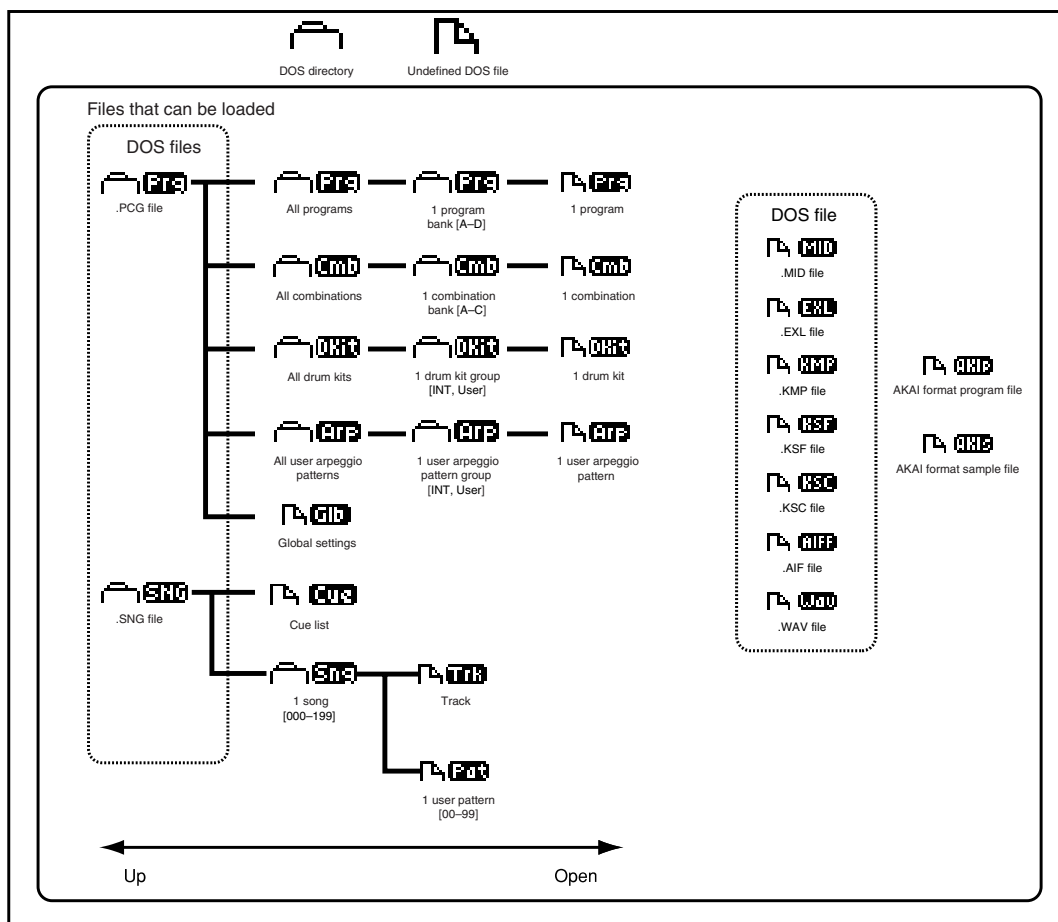

⚡ If you want to load programs, combinations, songs, user drum kits, and user arpeggio patterns, you must first uncheck the memory protect setting in Global mode. (p.42)

① If you are loading data from SmartMedia, insert the SmartMedia into the SmartMedia slot.

For details on handling SmartMedia, please refer to "Cautions when handling SmartMedia."

If the separately sold EXB-SMPL option is installed and you are loading data from a hard disk or other external SCSI device, refer to the manual included with the EXB-SMPL, and verify that the external SCSI device is connected correctly and that the media contains the file you want to load.

② Enter Media mode, and press a function key to make the TRITON Le recognize the media.



③ Select the Load page.

The LCD screen will display file information.

④ If you are loading from an external SCSI device, use the [INC]/[DEC] keys to select the media that contains the data you want to load.

⑤ Use the [▲], [▼] cursor keys to select a .PCG file.

The selected file will be highlighted.

note If the data you want to load is located in a lower or higher level of the directory structure, press the [F6] ("OPEN") or [F5] ("UP") keys to display the desired data, and then select it.

⚡ When you load a .PCG file, the data in the internal memory of the TRITON Le will be overwritten by the data from the .PCG file (programs, combinations, drum kits, user arpeggio patterns, global settings). If internal memory contains data that you want to keep, use "Save All" or "Save PCG" to save it before you load other data.

⑥ In the Utility menu, select "Load Selected."



A dialog box will appear. The display and operations will differ depending on the type of file that is to be loaded. For details on each type of file, refer to PG p.141.

⑦ If you execute the Load operation with "Load *****.SNG too" checked, the .SNG file will be loaded at the same time as the .PCG file.

If you execute the Load operation with "Load *****.KSC too" checked, the .KSC file will be loaded at the same time as the .PCG file.



⑧ Press the [F8] ("OK") key to execute the Load operation.

⚡ Loading will be halted if the specified data is not found in the file. (p.141)

⚡ Never remove the media while the data is being loaded.

Saving data

For the procedure of saving data to a SmartMedia or to external SCSI media, refer to "Saving on external media" (p.45).

Types of data that can be saved

The following types of data can be saved on external media (SmartMedia etc.). If the separately sold EXB-SMPL option is installed, data can also be saved on high-capacity media such as a hard disk.

- **.PCG files**
Programs, combinations, global settings, drum kits, user arpeggio patterns (the data specified by the "S.Item" (Select Save Items) check boxes when saving will be saved).
- **.SNG files**
Songs, cue lists
- **.KSC files**
Script file (.KSC files) listing the multisamples and samples created in Sampling mode (if the separately sold EXB-SMPL option is installed), with multisamples (.KMP files) and samples (.KSF files)
- **Standard MIDI files (SMF)**
A single pattern of Sequencer mode can be saved as SMF data.
- **System exclusive data**
System exclusive data received by the TRITON Le from an external MIDI device (the TRITON Le can be used as a data filer).
- **.WAVE files, .AIFF files**
Samples you created in Sampling mode (if the separately sold EXB-SMPL option is installed) can be exported and saved as .WAVE files or .AIFF files.

note For details on each type of file and the icon associated with it, refer to the lower diagram on p.97.

Arpeggiator settings

This chapter describes the procedure for making arpeggiator settings in each mode. For details on the arpeggiator function, refer to “Using the arpeggiator while you play” (p.26).

Arpeggiator settings for a program

Arpeggiator on/off

Each time you press the [ARP ON/OFF] key, the arpeggiator will be switched on or off. When on, the [ARP ON/OFF] key will light. When you play the keyboard, an arpeggio will play according to the selected arpeggio pattern.

note The on/off setting is stored when the program is written.

Arpeggiator settings

- 1 Select the PROG 6.1: Ed-Arp., Arpeg. Setup page.

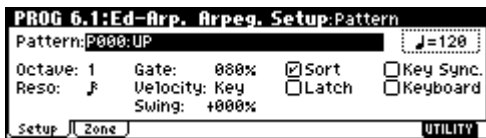

- 2 Use “♪ (Tempo)” to set the tempo.

You can adjust the tempo by rotating REALTIME CONTROLS C-mode [TEMPO] knob. The LED will blink at the specified tempo.

MIDI If “MIDI Clock” (GLOBAL 2.1: MIDI) is set to **External**, the display will indicate “♪ = EXT.” This setting lets you synchronize the tempo with an external MIDI device. In this case, it will not be possible to change the tempo on the TRITON Le.

- 3 In “Pattern,” select the arpeggio pattern.

You can select from preset arpeggio patterns P000–P004 and user arpeggio patterns U000 (INT)–215 (User).

The way in which the pattern is played will depend on settings such as “Octave” and “Sort.” P000–P004 in the following diagrams show how the arpeggio will be played when “Octave” is set to 1, and “Sort” is checked. P004: RANDOM is one possibility.

P000: UP

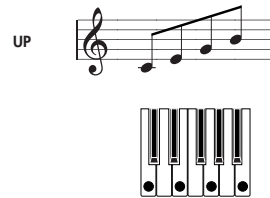

P001: DOWN

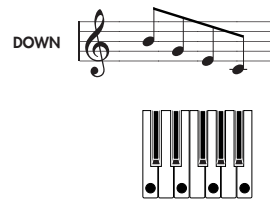

P002: ALT1

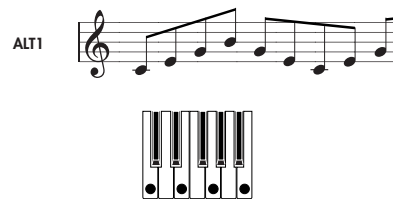

P003: ALT2

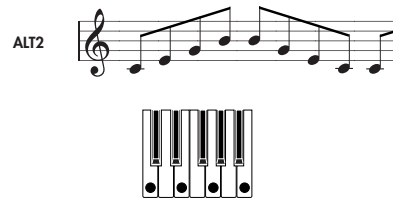

P004: RANDOM

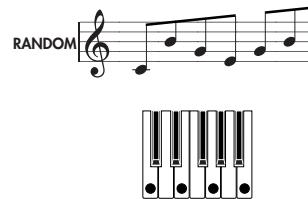

U000 (INT)–U199 (INT)

With the factory settings, various arpeggio patterns are preloaded. These include a variety of patterns such as drum or bass phrases, or guitar or keyboard backing riffs (p. VNL).

U200 (User) – U215 (User)

With the factory settings, these do not contain patterns.

④ **Make settings for the various parameters.**

“**Octave**”: Select the octave range in which the arpeggio will be played.

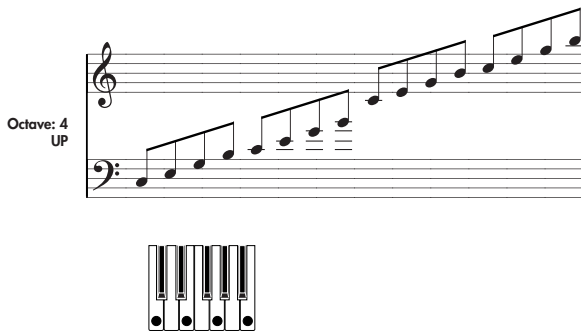

⚡ If a user arpeggio pattern is selected, the “Octave Motion” setting (GLOBAL 6.1: Arp.Pattern, Setup page) will affect the way in which the arpeggio is played.

“**Reso**”: Specifies the timing value of the arpeggio notes over a range of $\frac{1}{3}$ – $\frac{1}{2}$.

“**Gate**”: Specifies the length (gate time) of each note in the arpeggio. If a user arpeggio pattern is selected, you can set this to **Step**. In this case, the value of the “Gt” setting for each step (GLOBAL 6.1: Arp.Pattern, Edit page) will be used.

⚡ This value will be in effect when the REALTIME CONTROLS C-mode [ARP-GATE] knob is in the center position (12 o’clock). Be sure that the knob is in the center position when you make this setting.

“**Velocity**”: Specifies the velocity of the notes in the arpeggio. If this is set to **Key**, the velocity with which you actually played the note will be used. If a user arpeggio pattern is selected, you can set this to **Step**. In this case, the value of the “Vel” setting for each step (GLOBAL 6.1: Arp.Pattern, Edit page) will be used.

⚡ This value will be in effect when the REALTIME CONTROLS C-mode [ARP-VELOCITY] knob is in the center position (12 o’clock). Be sure that the knob is in the center position when you make this setting.

note When a preload user arpeggio pattern is selected, setting the “Gate” or “Velocity” to **Step** will add a sense of groove to the arpeggio pattern.

“**Swing**”: This adjusts the timing of the even-numbered notes in the arpeggio (counting from the first note), to give the pattern a sense of “swing.”

“**Sort**”: If this is **checked**, the arpeggio will be sounded in order of pitch, regardless of the order in which notes were played on keyboard (On).

If this is **unchecked**, the arpeggio will be sounded in the order in which the notes were played on keyboard (Off).

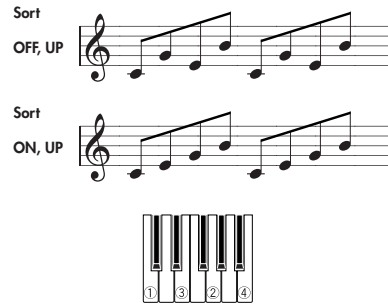

“**Latch**”: If this is **checked**, the arpeggio will continue playing even after you take your hand off the keyboard. If this is **unchecked**, the arpeggio will stop playing when you take your hand off the keyboard.

“**Key Sync**”: If this is **checked**, the arpeggio pattern will start from the beginning when you play a note after having released all notes. This setting is suitable when you are playing in realtime, and want the arpeggio to start at the beginning of the measure. If this is **unchecked**, the arpeggio pattern will always be synchronized to the tempo of the MIDI clock. For details on synchronization, refer to “Synchronizing the arpeggiator” (p.107).

“**Keyboard**”: If this is **checked**, the notes you play on the keyboard will be heard as well as the arpeggiated notes. If this is **unchecked**, only the arpeggiated notes will be heard.

The same setting can be made by editing the parameter of the same name (or abbreviation) in the PROG 1.1: Play, Arp.Play page.

note You can use the Utility “Copy Arpeggiator” to copy arpeggiator settings from another program or combination (p.25).

⑤ **In the Scan Zone page, specify the range in which the arpeggiator will operate.**

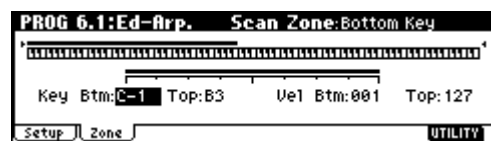

“**Key Btm**,” “**Key Top**”: The arpeggiator will operate when you play keys within the specified range. Keys outside of this range can be played in the normal manner, and will not be affected by the arpeggiator on/off.

note For example if you set “Pattern” to P000: UP, check “Latch,” set “Key Top” to B3, and “Key Btm” to C-1, playing a note B3 or lower will trigger the arpeggiator. Since “Latch” is on, the arpeggio will continue even after you release the keys. You can use the C4 and higher keys to play conventionally along with the arpeggio sounded by the B3 and lower keys. To change the arpeggio, play keys in the range of B3 and below.

“Vel Btm,” “Vel Top”: The arpeggiator will operate when you play notes with a velocity (playing strength) that is within the specified range. Notes played with a velocity outside this range will be sounded normally, without regard to the arpeggiator on/off.

- ⑥ If you wish to save the edited program settings to internal memory, turn off memory protect in Global mode, and write the program (p.42).

Linking the arpeggiator to a program

If you want the arpeggiator settings written in a program to be selected when that program is selected, check **Program** for “Auto Arp.” (GLOBAL 1.1: System, Basic page).

Arpeggiator settings in Combination and Sequencer modes

In Combination and Sequencer modes, the TRITON Le provides **dual arpeggiator** functionality that lets you use two arpeggio patterns simultaneously. The settings in each of these modes are made in the similar way.

As an example, the following explanation shows how to make settings in Combination mode. For a detailed explanation and example settings (p.43, 81).

The dual arpeggiator functionality lets you do the following things.

- Assign an arpeggiator for each timbre. Choose from **Off**, (arpeggiator) **A**, or (arpeggiator) **B**. step ⑤
- Independently specify whether **A** and **B** will operate. step ⑥
- Select an arpeggio pattern and set parameters independently for **A** and **B**. step ⑦
- Make Scan Zone page settings so that you can use keyboard range or playing velocity to switch between normal playing and arpeggiated playing, or to switch between arpeggiators **A** and **B**. step ⑧
- Make settings for timbres that will be silent when the arpeggiator is Off, and will sound only when the arpeggiator is On. step ⑩

Arpeggiator on/off

Each time you press the [ARP ON/OFF] key, the arpeggiator will be switched on or off. When on, the [ARP ON/OFF] key will light. The selected arpeggio pattern will begin when you play the keyboard. The on/off setting is saved when the combination is written into memory.

- ▲ If “Assign” is **Off** or “Arpeggiator Run” is not **checked**, the arpeggiator will not operate even if this key is on.

Arpeggiator settings

- ① Select COMBI 2.1: Ed-Prog/Mix, Prog page.

Select programs for the timbres that you wish to use. For this example, select any desired program for timbres 1–4.

- ② Select COMBI 3.1: Ed-Paraml. MIDI page.

For the timbres that you will be using, set “Status” to **INT**, and set “MIDI Channel” to **Gch** or to the global MIDI channel (set in GLOBAL 2.1: MIDI “MIDI Channel”).

For this example, set timbres 1–4 to a “Status” of **INT**, and timbres 5–8 to a “Status” of **Off**. Set the “MIDI Channel” of timbres 1–4 to **Gch**.

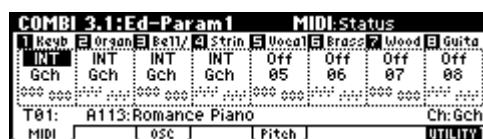

- ③ Select COMBI 6.1: Ed-Arp., Setup page.



- ④ Set “♩ (Temp)” to specify the tempo.

This is the same as for a program (p.99). However, the tempo is shared by both arpeggiators A and B.

- ⑤ Make “Assign” settings.

Assign arpeggiator A or B to the desired timbres. Each timbre will be played by the arpeggiator that has been assigned to it.

- ⑥ Make “Arpeggiator Run” settings.

Check the arpeggiator(s) that you want to operate. The arpeggiator(s) checked here will run when the [ARP ON/OFF] key is turned on.

With the settings shown in the LCD screen for steps ② and ③, turning the [ARP ON/OFF] key on will cause arpeggiator A to operate for timbres 1 and 2, and arpeggiator B to operate for timbre 3. When the [ARP ON/OFF] key is turned off, timbres 1–4 will sound as a layer.

If all timbres “Assign” are **Off**, or if neither “Arpeggiator Run” **A** or **B** is **checked**, the arpeggiator will not function.

- ⑦ In the Arp. A and Arp. B pages, set the parameters for arpeggiators A and B.

The parameters for A and B are the same as for a program (p.99).

- ⑧ In the Scan Zone page, specify the range in which arpeggiators A and B will operate.

The parameters for A and B are the same as for a program (p.99).

You can use keyboard ranges or playing velocity to operate the arpeggiator, or to switch between arpeggiators A and B. By using the COMBI 3.3: Ed-Key Zone, Key page and COMBI 3.4: Ed-Vel Zone, Vel page to set keyboard ranges and velocity ranges in conjunction with each other, you can create even more variations.

- ⑨ If you wish to save the edited combination settings in internal memory, turn off memory protect in Global mode, and write the combination. (ESP p.42).
- ⑩ The “Status,” “MIDI Channel” and “Assign” settings shown in the LCD screen of steps ② and ③ can be made so that certain timbres will sound only when the arpeggiator is On, and will be silent when the arpeggiator is not Off.

Although this is a somewhat sophisticated editing technique, we will describe the settings of one of the preset combinations as an example.

Combination A021: Urban Nature RnB

Select combination A021: Urban Nature RnB, and play it.

Before you play, make sure that the global MIDI channel (GLOBAL 2.1: MIDI “MIDI Channel”) is set to 01.

- Arpeggiator A is assigned to T (timbre) 4 and 8. When you play the keyboard, the arpeggio pattern U145(INT): Dr-Nature RnB will sound only the T4 program A004: Trance/GarageKit.
- The arpeggio pattern uses the Fixed Note setting, which is appropriate when playing a drum arpeggio. (“Fixed Note” is checked in, GLOBAL 6.1: Arp.Pattern, Setup page.) With this setting, the arpeggio pattern will always play the specified pitches regardless of the note numbers received from the keyboard. (ESP PG p.136)
- The A “Key Btm” and “Key Top” (COMBI 6.1: Ed-Arp., Scan Zone page) are set so that arpeggiator A will operate only for notes B3 and lower.
- Arpeggiator A is also assigned to T8, but this is so that the T4 program A004: Trance/GarageKit will sound only when the arpeggiator is on.

Notice the timbre settings for T4 and T8

	Status	MIDI Channel	Assign
T4	INT	02	A
T8	Off	Gch	A

- If the arpeggiator is off, playing the keyboard will sound the timbre(s) that are set to Gch or to the global MIDI channel (in this case, 01). Since the “MIDI Channel” of T4 is set to 02, it will not sound. T8 is set to Gch, but since “Status” is Off it will not sound.
- Any MIDI channel that is assigned to a timbre will trigger the arpeggiator. In this case, these will be “MIDI Channel” 02 and Gch (global MIDI channel). When the arpeggiator is on, playing the keyboard will trigger arpeggiator A which is assigned to T8

(Gch). T4 will be sounded by arpeggiator A. Since the “Status” of T8 is Off, it will not sound.

- Since the “Status” of T8 is Off, it will not sound, regardless of whether the arpeggiator is on or off. It is a dummy timbre that causes T4 to sound only when the arpeggiator is on.

Combination B071: “In The Pocket”

Select and play combination B071: “In The Pocket.”

Before you play, make sure that the global MIDI channel (GLOBAL 2.1: MIDI “MIDI Channel”) is set to 01.

- Arpeggiator A is assigned to T7 and T8, and arpeggiator B is assigned to T5. When you play the keyboard, the T7 program B004: HipHop Kit will be sounded by the arpeggio pattern U143(INT): Dr-In The Pocket. The T5 program A034: Chord Trigger will be sounded by the arpeggio pattern U100(INT): Bs-Echo.
- The B “Key Btm” and “Key Top” (COMBI 6.1: Ed-Arp., Scan Zone page) are set so that arpeggiators B will operate only for the G3 note and above.
- Arpeggiator B is assigned to T8 as well, but this setting is so that the T7 program B004: HipHop Kit will sound only when the arpeggiator is on. Refer to the preceding section “Select and play Combination A021: Urban Nature RnB.”

Linking the arpeggiator to the combination

If you want the arpeggiator settings of a combination to become active when that combination is selected, check “Combi” for “Auto Arp” (GLOBAL 1.1: System, Basic page).

Creating an user arpeggio pattern

About user arpeggio patterns

The patterns that can be selected on the TRITON Le's arpeggiator are called "arpeggio patterns." There are two types of arpeggio patterns: **preset arpeggio patterns** and **user arpeggio patterns**.

Preset arpeggio patterns: There are five patterns; UP, DOWN, ALT1, ALT2, and RANDOM.

The operation of these patterns is fixed, and cannot be edited.

User arpeggio patterns: There are 216 patterns - U000(INT)-U215(User) - which can develop chords or phrases in a wide variety of ways, based on the pitches that you play on the keyboard or the timing at which you play them.

In GLOBAL 6.1: Arp.Pattern you can modify these user arpeggio patterns, or create a new user arpeggio pattern from an initialized condition. Edited user arpeggio patterns can be written to internal memory areas U000(INT)-U215(User). In Media mode, they can also be saved on external media such as a SmartMedia.

(p.45)

Editing a user arpeggio pattern

When you wish to edit a user arpeggio pattern, first turn off memory protect by **unchecking** the Memory Protect "Arp. UsrPat" check box in the Preference page of GLOBAL 1.1: System.

If you enter this mode from the Program mode, your editing will apply to the arpeggio pattern specified for the selected program.

① In Program mode, select a program for which the arpeggio pattern you wish to edit is selected, or a program that you wish to use as a basis for editing the arpeggio pattern.

② Press the [ARP ON/OFF] key to turn the arpeggiator on (the key will light).

Even if you moved to Global mode from a program in which the arpeggiator was turned off, you can use the [ARP ON/OFF] key to turn it on.

③ Select the GLOBAL 6.1: Arp.Pattern, Setup page.



④ In "Pattern," select the arpeggio pattern that you wish to edit.

For this example, select an empty user arpeggio pattern.

If a blank pattern is selected, playing the keyboard will not start an arpeggio. Although preset arpeggio patterns P000-P004 can be selected, they cannot be edited.

When you edit a user arpeggio pattern, the changes will have an effect anytime that this pattern is used in Program, Combination, or Song.

⑤ In "Lgth (Length)," specify the length of the pattern.

After the pattern has played for the length specified, it will return to the beginning. This setting can also be changed during or after editing. For this example, set it to 8.

note For the preload arpeggio patterns U000(INT)-U199(INT), simply changing the "Lgth" can significantly change the character of the pattern. Try changing the length and listening to the result.

⑥ Make settings for the "J (Tempo)," "Reso (Resolution)," "Oct (Octave)," "Sort," "Latch," "K.Sync (Key Sync)," and "Kbd (Keyboard)" parameters.

These are program parameters, but can be set from here as well.

If after moving here from Program mode, you modify these parameters and wish to keep your changes, return to Program mode and write the program. These parameters are not saved by "Write Arpeggio Pattern."

For this example, make the settings shown in the illustration ③.

⑦ The "Type (Arpeggio Type)," "Octave Motion," and "Fixed Note" parameters specify how the arpeggio will be developed.

These settings can be changed during or after editing (PG p.136).

⑧ Select the Edit page.

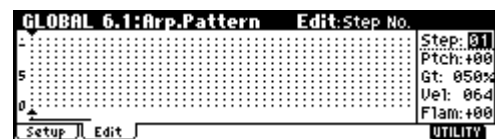

A pattern consists of Steps and Tones.

- Step:** A user arpeggio pattern can have a maximum of 48 steps. The arpeggiator will play from the first step, in steps equal to the timing value specified by "Reso (Resolution)." The vertical lines of the grid shown in the center of the LCD screen indicate the steps.

Use "Step (Step No.);" to select the step. For each step, specify "Ptch (Pitch Offset)," "Gt (Gate)," "Vel (Velocity)" and "Flam."

To change Step, you can either use the [◀], [▶] keys or select "Step (Step No.);" and use the [VALUE] dial or the [INC]/[DEC] keys.

- **Tone:** At each step, a chord consisting of up to 12 tones (Tone No. 00–11) can be sounded. To input tones, select “Step (Step No.)” and then use numeric keys [0]–[9], [-], and [./HOLD] to input tones. The “Tone No.” corresponds to the [0]–[9], [-], and [./HOLD] keys as shown below. Each time you press a [0]–[9], [-], or [./HOLD] key, the corresponding tone will be turned on/off. The horizontal lines of the grid shown in the center of the LCD screen indicate the tones.

Tone00–09: [0]–[9] keys
Tone10: [-] key
Tone11: [./HOLD] key

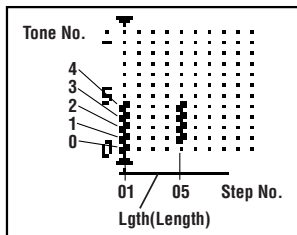

Creating an example pattern

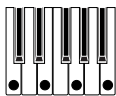

- ① Set “Step (Step No.)” to 01, and press the [0] key.
- ② Set “Step (Step No.)” to 02, and press the [1] key.
- ③ Set “Step (Step No.)” to 03, and press the [2] key.
- ④ Set “Step (Step No.)” to 04, and press the [1] key.
- ⑤ Set “Step (Step No.)” to 05, and press the [3] key.
- ⑥ Set “Step (Step No.)” to 06, and press the [1] key.
- ⑦ Set “Step (Step No.)” to 07, and press the [2] key.
- ⑧ Set “Step (Step No.)” to 08, and press the [1] key.

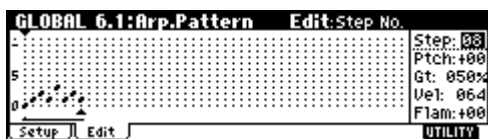

- ⑨ When you play the keyboard as shown in the illustration, the arpeggiator will begin playing.
Tone 0 corresponds to the pitch of the lowest key of chord you play on the keyboard. (If “Sort” is **unchecked**, it will correspond to the pitch of the first note you play.) Likewise, Tone 1 is the next highest pitch played on the keyboard, and so on up to 12 tones in any one step.
- ⑩ For steps 01–08, make settings for “Ptch (Pitch Offset),” “Gt (Gate),” “Vel (Velocity),” and “Flam.”
“Ptch (Pitch Offset)”: This offsets the pitch of the arpeggio note in semitones up or down. You can input the same tone for each step, and change the

“Ptch (Pitch Offset)” value for each to create a melody using a single tone. (≡ “Melody pattern”)

“Gt (Gate)”: Specify the length of the arpeggio note for each step. With a setting of **LGT**, the note will continue sounding either until the next note of the same tone or until the end of the pattern. With a setting of **Off**, the note will not sound.

“Vel (Velocity)”: Specify the strength of the note. With a setting of **Key**, the note will sound at the strength with which it was actually played.

- ⚡ The “Gt (Gate)” and “Vel (Velocity)” settings you make here will be valid if the “Gt (Gate)” and “Vel (Velocity)” parameters (PROG 6.1: Ed–Arp., Arpeg. Setup page) of the program selected in Program mode are set to **Step**. If these parameters have a setting other than **Step**, the “Gt (Gate)” and “Vel (Velocity)” that were specified for each individual step will be ignored, and all notes of the arpeggio will sound according to the settings in PROG 6.1: Ed–Arp. Be sure to verify the settings of the program.

- ⚡ Before you set “Gt (Gate),” move the REALTIME CONTROLS C-mode [ARP-GATE] knob to the center position (12 o’clock).

- ⚡ Before you set “Vel (Velocity),” move the REALTIME CONTROLS C-mode [ARP-VELOCITY] knob to the center position (12 o’clock).



- ⑪ To change the user arpeggio pattern name, use the Utility “Rename Arpeggio Pattern” (≡ p.43).
- ⑫ If you wish to save the edited user arpeggio pattern to internal memory, be sure to Write the user arpeggio pattern (≡ p.44).
 If you turn off the power without writing, the edited contents will be lost.
- ⑬ If you wish to save the state of the program at the same time, return to Program mode and write the program (≡ p.42).

Other examples of creating a user arpeggio pattern

Melody pattern

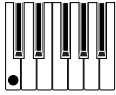

- ① Set "Step (Step No.)" to 01, and press the [0] key. Set "Ptch (Pitch Offset)" to +00.
- ② Set "Step (Step No.)" to 02, and press the [0] key. Set "Ptch (Pitch Offset)" to +10.
- ③ Set "Step (Step No.)" to 03, and press the [0] key. Set "Ptch (Pitch Offset)" to +00.
- ④ Set "Step (Step No.)" to 04, and press the [0] key. Set "Ptch (Pitch Offset)" to +00.
- ⑤ Set "Step (Step No.)" to 05, and press the [0] key. Set "Ptch (Pitch Offset)" to +12.
- ⑥ For "Step (Step No.)" 06, do not enter a tone.
- ⑦ Set "Step (Step No.)" to 07, and press the [0] key. Set "Ptch (Pitch Offset)" to +00.
- ⑧ Set "Step (Step No.)" to 08, and press the [0] key. Set "Ptch (Pitch Offset)" to -02.

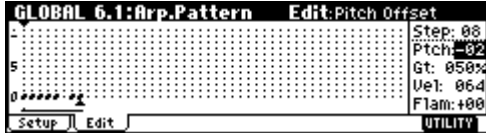

Chordal pattern

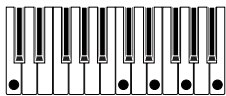

- ① Set "Step (Step No.)" to 01, and press the [0] key. Set "Gt (Gate)" to LGT.
- ② For "Step (Step No.)" 02, do not enter a tone.
- ③ Set "Step (Step No.)" to 03, and press the [1], [2], [3], [4] keys.
- ④ Set "Step (Step No.)" to 04, and press the [1], [2], [3], [4] keys.
- ⑤ For "Step (Step No.)" 05, do not enter a tone.
- ⑥ Set "Step (Step No.)" to 06, and press the [1], [2], [3], [4] keys. Set "Gt (Gate)" to LGT.
- ⑦ For "Step (Step No.)" 07, do not enter a tone.
- ⑧ Set "Step (Step No.)" to 08, and press the [1], [2], [3], [4] keys.

note To simulate the timing nuances of a strummed guitar chord, select "Flam." In Program mode, select an acoustic guitar program, and choose the user arpeggio pattern that you created here. In the Setup page of PROG 6.1: Ed-Arpeg., set "Gate" to Step.

Then return to the GLOBAL 6.1: Arp.Pattern, Edit page. For odd-numbered steps, set "Flam" to a positive (+) value. For even-numbered steps, set "Flam" to a negative (-) value.

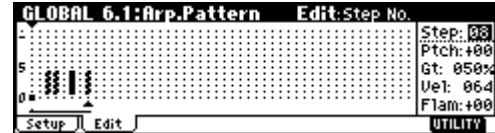

Drum pattern

You can use the arpeggiator to play a rhythm pattern by using "Fixed Note" with a drum program.

- ① Select a drum kit program.

For this example, select preset program A020: Standard Kit 1.

- ② Select the GLOBAL 6.1: Arp.Pattern, Setup page, and set the parameters.

Check "Fixed Note." If this is checked, tones will always sound at the specified pitch.

If you set "Mode (Fixed Note Mode)" to Trigger All Tones, playing a single note will cause all Tones to sound.

If you set "Mode (Fixed Note Mode)" to Trigger As Played, the notes you play will determine how Tones are sounded. (p.106)

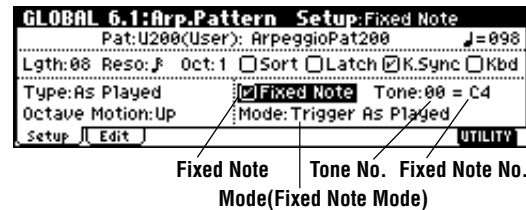

Fixed Note | Tone No. | Fixed Note No.
Mode(Fixed Note Mode)

If "Fixed Note" is checked, you will be able to set "Tone No." and "Fixed Note No."

Select "Tone No.," and then set "Fixed Note No." to specify the note number that the tone will sound. Here, set "Tone No." and "Fixed Note No." as follows.

Tone No.	Fixed Note No.
00	C2 (kick)
01	F2 (snare)
02	F#3 (closed hi-hat)
03	A#3 (open hi-hat)

The drumsamples that correspond to each note number will differ depending on the drum kit. You will find it convenient to audition the drum sounds from the keyboard, and then input the "Fixed Note No." by holding down the [ENTER] key and playing the desired note.

- ⑧ If you wish to save the state of the combination at the same time, return to Combination mode and write the combination (p.42).

note When editing a user arpeggio pattern, pay attention to the global MIDI channel, the channel of each track, and the arpeggiator assignments, and make sure that the arpeggiator you are hearing is the pattern that you wish to edit.

▲ If you moved here from Sampling mode (if the separately sold EXB-SMPL option is installed), the arpeggiator will not turn on. Nor will it be possible to edit arpeggio patterns.

Synchronizing the arpeggiator

The note timing of the arpeggiator will differ depending on the state of the arpeggiator “Key Sync.” check box.

If this is **checked**, the arpeggiator will operate at the timing of the first note-on you play from a state in which all keys are released.

If this is **unchecked**, the arpeggiator will operate in synchronization with the internal or external MIDI clock.

The paragraphs below explain how synchronization occurs when the “Key Sync.” check box is **unchecked**. (However, synchronization with Song Start and with the MIDI realtime command Start message are exceptions to this.)

Synchronization between arpeggiators A and B

In Combination and Sequencer mode, two arpeggiators can operate simultaneously. In this case, if you start an arpeggiator (whose “Key Sync.” is **unchecked**) while the other arpeggiator is already running, the arpeggiator you started will synchronize to the “♪ (Tempo)” based on the timing of the already-running arpeggiator.

note If “Key Sync.” is **checked**, A and B will each operate on their own timing.

Synchronization between the arpeggiators and sequencer in Sequencer mode

When song playback is stopped

- The arpeggiator will synchronize to the “♪ (Tempo)” based on the timing of the internal MIDI clock.
- In Sequencer mode when an RPPR pattern is playing, the arpeggiator will synchronize to the beats of that pattern.
- If you want the RPPR pattern playback to synchronize to the currently-running arpeggiator, set “Sync” (SEQ 5.1: RPPR, RPPR Setup page) to SEQ. Playback will synchronize to the “♪ (Tempo)” timing of the arpeggiator.

When a song is being played or recorded

- The arpeggiator will synchronize to the beats based on the timing of the song.

Synchronization with Song Start

- When the arpeggiator is on (the [ARP ON/OFF] key is on) and running, receiving a Song Start message will reset the arpeggiator to the beginning of the pattern. (This has no relation to the “Key Sync.” setting.)
- In Sequencer mode when the “Key Sync.” setting is **unchecked** and the [ARP ON/OFF] key is on, starting the arpeggiator by pressing notes during the pre-count before recording will cause the arpeggiator to start (and be recorded) from the beginning of the arpeggio pattern at the moment that recording begins.

Synchronization with an external sequencer in Program, Combination, or Sequencer modes

In Program, Combination, and Sequencer modes when “♪ (Tempo)” is EXT (GLOBAL 2.1: MIDI “MIDI Clock” set to **External**), the TRITON Le will synchronize to MIDI Clock and Start messages received from an external MIDI sequencer (or similar device) connected by a MIDI cable.

Synchronization to external MIDI clock

- The arpeggiator will synchronize to the “♪ (Tempo)” based on the timing of the external MIDI clock.

Synchronization to the MIDI Start message

- When the arpeggiator is on and operating, receiving a MIDI Start message will cause the arpeggiator to reset to the beginning of the pattern. (This has no relation to the “Key Sync.” setting.)

Effects settings

The effect section of the TRITON Le provides one **insert effect**, two **master effects**, one **master EQ** (stereo 3-band EQ), and a **mixer** that controls the routing of these components.

You can choose from 89 types of full-digital effects for each effect. The effects are categorized as follows.

Categories of the 89 effect types

01–15	Filter and dynamics effects, such as EQ and compressor
16–31	Pitch and phase modulation effects, such as chorus and phaser
32–40	Other modulation and pitch-shift effects such as rotary speaker and pitch shifter
41–51	Early reflection and delay effects
52–57	Reverb effects
58–89	Mono and mono-chain effects in which two mono effects are connected in series

Effects in each mode

In **Program mode**, **insert effect** can be used as part of the sound-creating process, in the same way that the output sound of the oscillator (OSC) is processed by the filter and amp to create the final sound. Then the **master effects** can be used to apply spatial-type effects such as reverb. The stereo 3-band **master EQ** located immediately before the OUTPUT (MAIN) L/MONO and R outputs is used to make final adjustments in tone. These settings can be made independently for each program.

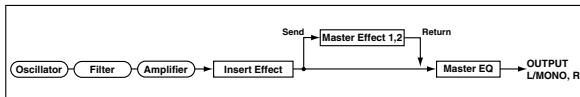

In **Combination mode**, and **Sequencer mode**, **insert effect** can be used to help create the sound of each timbre/track. The **master effects** are used to apply overall spatial processing, and the **master EQ** is used to make overall adjustments in tone.

These settings are made in Combination mode independently for each combination, and in Sequencer mode for each song the entire mode.

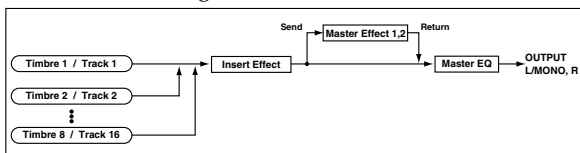

In **Sampling mode** (if the separately sold EXB-SMPL option is installed), the sound of an external source that is input from AUDIO INPUT 1 and 2 can be processed by the **insert effect** as the sound is sampled. Sampling mode settings are made by the "Input 1" and "Input 2" parameters of the SMPL 1.1: Recording, Input/Pref page. The settings here are valid only within Sampling mode.

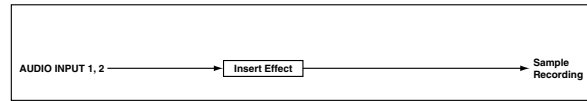

The external input from **AUDIO INPUT 1** and **2** (if the separately sold EXB-SMPL option is installed) can be used outside of Sampling mode. In Program, Combination, and Sequencer modes, the external input sound can be processed by the **insert effect**, **master effects**, and **master EQ**.

This means that you can use the TRITON Le as a 2-in/4-out effect processor.

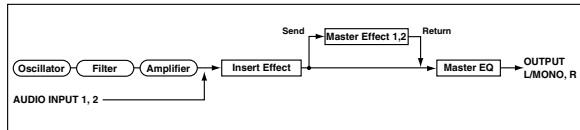

Routing settings and effect settings

The insert effect, master, effects, and master EQ that can be used in each mode are structured identically. However, you can change the routing to specify how the oscillator(s) of a program, the timbres of a combination, or the tracks of a song will be sent to the insert effect or master effects. In the pages that follow, we will explain how you can make routing settings and effect settings in each mode.

Effect settings for a program

Routing

- ① Select the PROG 7.1: Ed-InsertFX, BUS page.

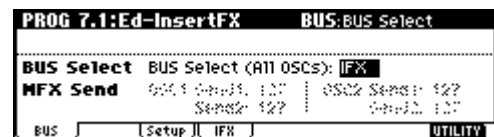

- ② Set "BUS Select (All OSCs)" to specify where the oscillator output will be sent.

L/R: The output will not be sent to the insert effect. After passing through the master EQ, the sound will be sent to AUDIO OUTPUT (MAIN) L/MONO and R.

IFX: The output will be sent to insert effect IFX.

1, 2, 1/2: The output will be sent to AUDIO OUTPUT (INDIVIDUAL) 1 or 2. It will not be sent to the insert effect, the master effects, or the master EQ.

Off: The output will not be sent to AUDIO OUTPUT (MAIN) L/MONO, R, or to (INDIVIDUAL) 1, 2 (After passing through the master effects, it will be output from AUDIO OUTPUT (MAIN).) Select this when you wish to connect the output to the master effects in a series connection at the send levels specified by “MFX Send.”

- ③ “MFX Send” specifies the send level from each oscillator to the master effects.

This is valid only if “BUS Select (All OSCs)” is set to L/R or Off.

If IFX is selected for “BUS Select (All OSCs),” the send level to the master effects is adjusted by the “Send 1 (MFX1)” and “Send 2 (MFX2)” parameters (PROG 7.1: Ed-InsertFX, Setup page) after the signal has passed through the insert effect.

Insert effect

- ① Access the PROG 7.1: Ed-InsertFX, Setup page.

The Setup page displays the state of the routing and insert effect settings. In this page you can also make “BUS Select” settings. Use the [▲], [▼] cursor keys to select (All OSCs), and use the [INC]/[DEC] keys to make the setting.

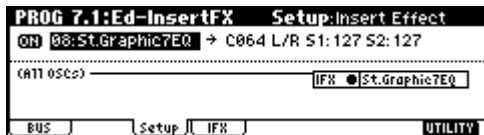

- ② In “Insert Effect,” select the desired insert effect.

note You can use the Utility “Select by Category” to select effects from six categories.

- ③ In “On/Off,” turn the insert effect on/off.

If this is set to Off, the result will be the same as if 00: No Effect is selected. The input sound will be output without change.

note You can use the Utility “Copy Insert Effect” to copy effect settings from another program, etc.

- ④ Set the “Pan (CC#8),” “BUS Select,” “S1 (Send1 (MFX1)),” and “S2 (Send2 (MFX2))” parameters that follow the insert effect.

“Pan (CC#8):” Set the pan. This is valid only if “BUS Select” is set to L/R.

“BUS Select”: Specify the output destination. Normally you will set this to L/R. If you want to output the sound from AUDIO OUTPUT (INDIVIDUAL) 1 and/or 2, set this to 1, 2, or 1/2.

“Send1 (MFX1),” “Send2 (MFX2):” Set the send level to the master effects. For this example, set these to 127.

- ⑤ Move to the IFX page, and set the parameters of the effect that you selected for the insert effect.

For details on the parameters of each effect, refer to PG p.164–.

Master effects

The input level of the master effect is determined by the send level 1 and 2 settings (routing step ③, or insert effect step ④). If send levels 1 and 2 are 0, no master effects will be applied. Send level 1 is for MFX1, and send level 2 is for MFX2.

- ① Select the PROG 7.2: Ed-MasterFX, Setup page.

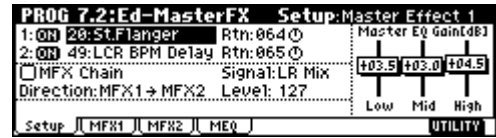

- ② In “Master Effect 1” and “Master Effect 2,” select the type of each master effect.

The procedure is the same as for the insert effect. (step ①)

- ⚠ The input/output of the master effect is mono-on/stereo-out. Even if you select a stereo-input type effect, the input will be monaural.

- ③ In “On/Off,” switch each master effect on/off.

If this is Off, the output of the master effect will be muted.

- ④ Specify the routing of master effects 1 and 2.

For details on the routing settings, refer to PG p.159.

- ⑤ In “Rtn (Return 1, 2),” adjust the output level of each master effect.

- ⚠ For each effect, the W value of “W/D” (Wet/Dry) is the effect output level. This is multiplied by the return value (“Rtn”=127 is x1.0) to determine the actual master effect output level.

- ⑥ Move to the MFX1 or MFX2 page, and set the parameters of the effect that you selected as the master effect.

For details on the parameters of each effect, refer to PG p.164–.

Master EQ

- ① Use the stereo 3-band master EQ to make final equalizing adjustments immediately before the sound is output from the AUDIO OUTPUT L/MONO and R jacks.

Master EQ settings can be made in “Master EQ Gain [dB]” of the PROG 7.2: Ed-MasterFX, Setup page, or in the Master EQ page.

For details on master EQ parameters, refer to PG p.209.

Effect settings in combination, and song

In Combination, and Sequencer modes, you can specify the routing of each timbre/track to the insert effect and master effects. These settings are made in the same way in each of these modes. We will be using the example of Combination mode in our explanation here.

Routing

- 1 Select the COMBI 7.1: Ed-InsertFX, BUS page.



- 2 In "BUS Select," specify where the output of each timbre will be sent.
- 3 "S1 (Send1(MFX1))," "S2 (Send2(MFX2))" specifies the send level from each timbre to the master effects.

This can be set only if "BUS Select" is set to L/R or Off.

- ⚠ The actual send level will be the send level of each timbre multiplied by the send level of each oscillator of the program selected for the timbre. If the send level of a program is 0, the actual level will be zero even if the send level setting is raised here.

If IFX is selected for "BUS Select," set the send levels to the master effects by adjusting the "S1 (Send1(MFX1))" and "S2 (Send2(MFX2))" parameters (COMBI 7.1: Ed-Insert FX, Setup page) located after the signal has passed through the insert effect.

Insert effect

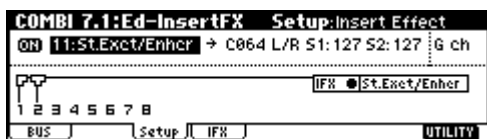

The Setup page displays the state of the routing and insert effect settings. "BUS Select" settings can also be made in this page. Use the cursor keys [▲], [◀], [▼], [▶] to select the timbre, and use the [INC]/[DEC] keys to make the setting.

In this example, IFX is used by 1 (timbre 1) and 2 (timbre 2).

In the same way as for a program, you can select the insert effect, turn it on/off, and set the "Pan (CC#8)," "BUS Select," "S1 (Send 1 (MFX1))," and "S2 (Send2(MFX2))" parameters that follow the insert effect. (p.109)

Master effects Master EQ

These settings are made in the same way as for programs (p.109).

Effect settings in Sampling mode (requires the EXB-SMPL option)

In Sampling mode, insert effect can be applied to an external audio source connected to the AUDIO INPUT 1 and 2 jacks, and sampled.

Routing

- 1 Select the SMPL 1.1: Recording, Input/Pref page.

The parameters in "Input1" and "Input2" specify the insert effect to which the external audio input from the AUDIO INPUT 1 and 2 jacks will be sent. For details on these settings, refer to "Sampling" (p.34).

Insert effect

Select the effect that will be used by the insert effect, and set the "Pan (CC#8)." (p.109)

Master effects Master EQ

The master effects and master EQ cannot be used in Sampling mode.

Effect settings for the AUDIO INPUT (requires the EXB-SMPL option)

Even in modes other than Sampling mode, the TRITON Le's effects can be applied to the external audio source connected to the AUDIO INPUT 1 and 2 jacks. The effect section of the TRITON Le can be used as a 2-in 4-out effect processor.

Routing

In modes other than Sampling mode (i.e., in Combination, Program, and Sequencer modes) the audio input routing from the AUDIO INPUT 1, 2 jacks is specified in the GLOBAL 1.1: System, Audio In page.

① Enter Global mode from Program mode.

If you enter Global mode from Sampling mode, the "Input 1" and "Input 2" settings of Sampling mode will be maintained, and you will not be able to hear the settings made in Global mode. You must move here from a mode that can access external audio signals (Combination, Program, or Sequencer). In Sampling mode, the settings you make here are ignored. AUDIO INPUT 1, 2 settings for Sampling mode are made by the "Input 1" and "Input 2" parameters in the In/Pref page of SMPL 1.1: Recording (p.110, PG p.126).

② Select the GLOBAL 1.1: System, Audio In page.



③ Set the parameters for "Input1" and "Input2."

"Input1" corresponds to AUDIO INPUT 1 jack and "Input2" corresponds to AUDIO INPUT 2 jack.

"Level": Set the signal level from AUDIO INPUT 1 and 2. Normally you will set this to 127. If the sound is still distorted even when this level is lowered significantly, it is possible that the distortion is occurring before the AD converter. Adjust the [LEVEL] knob or the output level of your external audio source.

"Pan": Set the panning of the signal from AUDIO INPUT 1 and 2. When you are inputting a stereo audio source, you will normally set Input 1 to L000, and Input 2 to R127 (or Input 1 to R127, and Input 2 to L000). When you are inputting a monaural audio source, you will normally set this to C064.

"BUS (IFX/Indiv.) Select": In the same way as for the oscillator of a program, specify the bus to which the external audio source from AUDIO INPUT jacks 1 and 2 will be sent (p.108).

"Send 1," "Send 2": Specify the send levels from the AUDIO INPUT 1, 2 (external input sound) to the master effects, in the same way as for the program oscillators. This setting can be made only if "BUS (IFX/Indiv.) Select" is L/R or Off (p.109).

If "BUS (IFX/Indiv.) Select" is set to IFX, this is set by "Send1 (MFX1)" and "Send2 (MFX2)" (Setup

page) after the sound has passed through the insert effect.

If "BUS (IFX/Indiv.) Select" is set to other than Off and "Level" is raised, the external audio source will be input to the TRITON Le. At this time, if audio cables are connected to the AUDIO INPUT 1, 2 jacks, any noise component will be input to the TRITON Le even if there is no actual audio input, and (depending on the settings) will be output from the AUDIO OUTPUT L/MONO, R, 1, 2 jacks. If you are not using an external audio source, and are playing only the internal programs, combinations, and songs, you should set "BUS (IFX/Indiv.) Select" to Off, or set "Level" to 0.

If audio cables are not connected to the rear panel AUDIO INPUT 1, 2 jacks, the input to the TRITON Le will be 0.

About dynamic modulation (Dmod) D_{mod}

Dynamic modulation (Dmod) is a function that lets you use MIDI messages or the TRITON Le's controllers to control specific effect parameters in realtime. BPM/MIDI Sync is another function that controls effect parameters, and is used to synchronize the LFO speed of modulation-type effects or the delay time etc. of delay-type effects to the tempo of the arpeggiator or an external sequencer.

For details on each of these functions, refer to PG p.217.

Setting example:

We will show how you can use dynamic modulation to control an effect parameter in realtime.

- As described in the procedure for "Effect settings for a program" (p.108), set "IFX" to 49: LCR BPM Delay. Verify that a delay sound is being output.
- Select the PROG 7.1: Ed-InsertFX, IFX page.

Using the Dmod function to vary the delay level by pushing the joystick

- Set "InLvl Mod" to +100.
- Set "Src" to JS+Y#1.

The joystick will control the input level to the effect. When you set "Src" to JS+Y#1, the delay sound will no longer be output; however it will gradually increase as you move the joystick away from yourself.



Using the Dmod function to vary the feedback level by operating [SW1] key

- ⑤ In the PROG 2.2: Ed-Ctrl, Controls page, set the function of "SW1" to SW1 Mod. (CC#80), Toggle.
- ⑥ Return to the PROG 7.1: Ed-InsertFX, IFX page, and set the C Fb (C Delay Feedback) "(Source)" to SW1 #80.
- ⑦ Set "(Amount)" to +30.

PROG 7.1:Ed-InsertFX		IFX:LCR BPM Delay	
BPM:	120	TimeOver?	>
L Bs: ♯	Times:3	Level:20	HiDamp: 0% LoDamp:0%
C Bs: ♯	Times:1	Level:20	InLv1 Mod: +100 Src:JS+Y#1
R Bs: ♯	Times:1	Level:20	Spread: 50
C Fb:	+10	SW1#80/+30	W/D: 50:50 Off /+0
BUS		Setup	IFX
		UTILITY	

- ⑧ Press the [Exit] key etc. to return to the PROG 1.1: Play page.

When you (move the joystick away from yourself and) press the [SW1] key, the feedback level will increase, and the delay sound will continue repeating.

The "(Amount)" setting determines the feedback level when the [SW1] key is pressed. If you set "(Amount)" to -10 and press the [SW1] key, the feedback level will be 0.

Using the BPM/MIDI Sync. function to synchronize the delay time to arpeggiator tempo changes.

- ⑨ Set "BPM" to MIDI.
- ⑩ For L, C, and R, set "L/C/R Bs" and "Times" as desired.

For this example, set "L/C/R Bs" to ♯ and "Times" to 1 so that the effect will be easily understandable. The delay time will repeat at an interval of a 8th note.

PROG 7.1:Ed-InsertFX		IFX:LCR BPM Delay	
BPM:	120	TimeOver?	>
L Bs: ♯	Times:1	Level:20	HiDamp: 0% LoDamp:0%
C Bs: ♯	Times:1	Level:20	InLv1 Mod: +100 Src:JS+Y#1
R Bs: ♯	Times:1	Level:20	Spread: 50
C Fb:	+10	SW1#80/+30	W/D: 50:50 Off /+0
BUS		Setup	IFX
		UTILITY	

- ⑪ Set the realtime controller function to C-mode, and rotate REALTIME CONTROLS knob [4] ("TEMPO").

When you (move the joystick away from yourself and) rotate the knob, the delay time will change.

- ⑫ Turn on the [ARP ON/OFF] key to start the arpeggiator.

Move the joystick away from yourself and select the desired arpeggio pattern.

When you rotate REALTIME CONTROLS knob [4], the delay time will change in synchronization to any changes you make in the arpeggiator tempo.

- ⚠ If you rotate the REALTIME CONTROLS knob [4] to change the tempo while the delay is sounding, noise may occur in the delay sound. This is because the delay sound becomes discontinuous, and is not a malfunction.

note For some effects, you can synchronize the LFO frequency to the tempo. Set the effect parameters "BPM/MIDI Sync" to On, and "BPM" to MIDI. For details refer to PG p.168.

Other functions

Tuning to another instrument/ Transposing

When you play this instrument together with other instruments, or along with music on a CD or tape, you may need to adjust the tuning so that the pitch matches. To adjust the tuning, use GLOBAL 1.1: System Basic page “Master Tune.” The tuning can be adjusted in a range of -50 – +50 cents (one semitone is 100 cents).

You can also transpose by changing the pitch in semitone steps. To transpose the pitch of the entire this instrument, use GLOBAL 1.1: System Basic page “Key Transpose.” The pitch can be transposed over a range of ± 1 octave.

Here we will explain how to adjust the tuning and transposition of the entire this instrument in Global mode.

- ① Press the [GLOBAL] key to enter Global mode.
- ② Press the [EXIT] key.
- ③ Press the [F1] (“Basic”) key.
- ④ To adjust the tuning, select “Master Tune.” to adjust the transposition, select “Key Transpose.”
- ⑤ Use the VALUE controllers to adjust the setting.

You can use numeric keys [0]–[9] to enter a value and press the [ENTER] key. Alternatively, you can use the [VALUE] dial, or the [INC]/[DEC] keys.

note If you wish to keep this setting after the power is turned off, you must Write the Global settings to memory. (PG p.42)

Bypassing the effects

Normally, effects are turned on/off within each program, combination, or song, or in Sampling mode. However if you want the entire-instrument to not use any effects, you can use this Global bypass feature.

- ① Press the [GLOBAL] key to enter Global mode.
- ② Press the [EXIT] key.
- ③ Press the [F1] (“Basic”) key.
- ④ To turn off insert effect, check the “IFX Off” check box.

To turn off master effect 1, check the “MFX1 Off” check box. To turn off master effect 2, check the “MFX2 Off” check box.

Specifying the function of the Assignable Switch and Assign- able Pedal

Set the assignable function of a footswitch (such as the Korg PS-1) connected to the ASSIGNABLE SWITCH jack.

This switch can act as a source for alternate modulation or effect dynamic modulation, or switch portamento on/off, control the sostenuto effect, turn the soft pedal effect on/off, turn the arpeggiator on/off, select programs or combinations (up/down), start/stop the sequencer, punch-in/out on the sequencer, or be a trigger to advance the cue list step (PG p.222).

- This setting is made in GLOBAL 1.1: System, Foot page “Foot SW Assign.”

You can specify the assignable function that will be performed by a footpedal (such as the Korg XVP-10 EXP/VOL or EXP-2) connected to the ASSIGNABLE PEDAL jack.

This pedal can be used to control master volume, alternate modulation or effect dynamic modulation, portamento pitch change speed, volume, the pan following an insert effect, pan, volume, or send levels to the master effects (PG p.223).

- This setting is made in GLOBAL 1.1: System, Foot page “Foot Pedal Assign.”

note You can use this as a source for alternate modulation or effect dynamic modulation, and use it to control program parameters or effect parameters. In this case, set “Foot Switch Assign” to Foot SW (CC#82), and “Foot Pedal Assign” to Foot Pedal (CC#04).

Here we will show how to make settings that allow an assignable switch to change programs or combinations.

- ① Connect a Korg PS-1 pedal switch (or other momentary footswitch) to the ASSIGNABLE SWITCH jack.
- ② Press the [GLOBAL] key to enter Global mode.
- ③ Press the [EXIT] key.
- ④ Press the [F3] (“Foot”) key.
- ⑤ Select “Foot SW Assign,” and select either Program Up or Program Down.

If you select Program Up, the next higher program number will be selected each time you press the foot switch.

If you select Program Down, the next lower program number will be selected each time you press the foot switch.

- ⑥ Set “Foot SW Polarity” to the polarity of the pedal

you connected.

If you connected a Korg PS-1 pedal switch, select (-) **KORG Standard**. The pedal will not function correctly if you do not select the correct polarity.

note If you wish to keep this setting after the power is turned off, you must Write the Global settings to memory. (p.44)

- ⑦ Press the [PROG] key to enter **PROG 1.1: Play**, or press the [COMBI] key to enter **COMBI 1.1: Play**. Then press the foot switch, and the program/combination will change.

Selecting different Velocity and Aftertouch curves

You can change the way in which velocity or after touch will affect the volume or tone. Using this feature, you can (for example) make the volume of the notes more consistent even when they are played with varying velocities (dynamics). Each curve has its own character, so you can select the curve that is appropriate for your own playing dynamics, playing style, and the effect that you wish to obtain (PG p.122).

- ① Press the [GLOBAL] key to enter **Global mode**.
- ② Press the [EXIT] key.
- ③ Press the [F1] (“Basic”) key.
- ④ To change the velocity curve, select “Velocity Curve” and specify the desired curve.

To change the after touch curve, select “AfterT Curve,” and specify the desired curve.

note If you wish to keep this setting after the power is turned off, you must Write the Global settings to memory. (p.44)

note This setting will affect the operation of the entire this instrument.

note Each program has parameters that allow you to adjust the effect of velocity (playing dynamics), and the change will depend on the settings of these parameters. These parameters can be individually set in detail in Program mode.

Creating original scales

You can create your own original scales. You can create sixteen different User Octave Scales in which the pitch of each note in the octave is repeated for all octaves, and one User All Note Scale in which the pitch of each of the 128 notes can be specified independently.

note If you wish to keep this setting after the power is turned off, you must Write the Global settings to memory. (p.44)

The user scales you create here can be used by specifying the scale for a program, for each timbre of a combination, or for each track of a song (“Changing the scale”)

Changing the scale

You can specify the scale for each program, for each timbre in a combination, or for each track of a song (Sequencer mode).

These settings are made by “Type” in the following pages, and by “Use Program’s Scale” for a combination or sequencer.

Program mode	PROG 2.1: Ed-Basic, Prog Basic
Combination mode	COMBI 3.2: Ed-Param2, Other
Sequencer mode	SEQ 3.2: Param2, Other (Othr..8/Othr..16)

Here we will show how to make settings in Sequencer mode.

- ① Press the [SEQ] key to enter **Sequencer mode**.
- ② Press the [MENU] key, and then press the [F3] key to select “Prm2” Press the [F8] (“Open”) key.
- ③ Select the [F1] (“Othr..8”) key or the [F2] (“Othr..16”) key.
- ④ If you wish to use the scale that is specified for the program used by a track, check the “Use Prog’s Scale” check box for that track.

Tracks that are not checked will use the scale specified by Scale “Type.”

- ⑤ Set “Type (Song’s Scale)” to select the scale for the entire currently selected song.

note If you wish to keep this setting after the power is turned off, you must Write the Global settings to memory. (p.42-)

Setting the function of [SW1] and [SW2]

You can specify the function of the [SW1] and [SW2] keys (PG p.220).

The functions of the [SW1] and [SW2] keys are set independently for each program, combination, and song. In and Sampling mode, the functions of these keys are set for the entire mode.

You can specify the function that will be performed by the [SW1] and [SW2] keys, and can also select between **Toggle** (when the function will be switched on/off each time the [SW1] or [SW2] key is pressed) and **Momentary** (when the function will be on only while you continue holding the [SW1] or [SW2] key).

These settings are made by “SW1/2 Assign” in the following pages.

Program mode	PROG 2.2: Ed-Ctrl, Controls
Combination mode	COMBI 2.2: Ed-Ctrl, Controls
Sequencer mode	SEQ 2.2: Controller, Controls
Sampling mode*	SMPL 5.2: Controller, Controls

*: If the EXB-SMPL option is installed

note When you write a program or combination, the on/off status of the [SW1] and [SW2] keys is memorized.

note You can use these keys as alternate modulation or effect dynamic modulation sources, and control program parameters or effect parameters. In this case, you will normally select **SW1 Mod.(CC#80)** and **SW2 Mod.(CC#81)**.

For an example in which the [SW1] key is specified as an effect dynamic modulation source for a program and used to control an effect, refer to p.111.

note If you wish to keep this setting after the power is turned off, you must Write the Global settings to memory. (p.42-)

note The settings of Sampling mode cannot be saved.

Setting the B-mode functions of REALTIME CONTROLS [1]–[4]

You can specify the B-mode functions of REALTIME CONTROLS knobs [1]–[4]. (PG p.221)

The B-mode functions are set independently for each program, combination, or song. The functions in Sampling mode (if the separately sold EXB-SMPL option is installed) are set for the entire mode.

These settings are made by “Knob B Assign” in the following pages.

Program mode	PROG 2.2: Ed-Ctrl, Controls
Combination mode	COMBI 2.2: Ed-Ctrl, Controls
Sequencer mode	SEQ 2.2: Controller, Controls
Sampling mode*	SMPL 5.2: Controller, Controls

*: If the EXB-SMPL option is installed

note You can use these knobs as sources for alternate modulation or effect dynamic modulation, and control program parameters or effect parameters. In this case, you will normally select **Knob Mod.1(CC#17)**, **Knob Mod.2(CC#19)**, **Knob Mod.3(CC#20)**, and **Knob Mod.4(CC#21)**.

Here we will give an example of how knob [1] can be used to control the filter and amp EG attack of a program.

- ① Press the [PROG] key to enter Program mode.
- ② Press the [MENU] key, and then press the [F2] key to select “Ctrl” Press the [F8] (“Open”) key.
- ③ Select the Knob 1-B “Knob B Assign”, and select F/A Attack (CC#73).
- ④ Press the REALTIME CONTROLS [SELECT] key to select B-mode, and turn knob [1] to control the EG attack of the filter and amp.

note If you wish to keep this setting after the power is turned off, you must Write the Global settings to memory. (p.42-)

note The settings of Sampling mode cannot be saved.

Adjusting the contrast (brightness) of the LCD screen

Use the GLOBAL 1.1: System, Preference page “LCD Contrast” to make adjustments. (☞p.117, PG p.125)

Using this instrument as a data filer

MIDI exclusive data transmitted from an external device can be received by this instrument and saved on a SmartMedia (the Data Filer function). This is done using the Media mode Save page “Save Exclusive” (☞PG p.150).

Shortcuts

[MENU] key + numeric keys [0]–[9] x2

- Access the various pages within each mode. Hold down the [MENU] key, and use numeric keys [0]–[9] to input a two-digit page number.

[MENU] key + [◀], [▶] keys

- Access the various pages within each mode. Hold down the [MENU] key, and use the [◀], [▶] keys to move.

[TIMBRE/TRACK] key + function keys [F1]–[F8]

- Access the parameters within each page. In pages of Combination Sequencer mode that show timbres 1–8/tracks 1–8 or 9–16 (such as COMBI 1.1: Play, Prog), hold down the [TIMBRE/TRACK] key and press the [F1 T1/T9]–[F8 T8/T16] keys to move the cursor.

[ENTER] key + numeric keys [0]–[9]

- Access the Utility menu commands of each page (up to ten items). Hold down the [ENTER] key and press a numeric key [0]–[9] to select from up to ten of the Utility menu items.

[ENTER] key + keyboard

By holding down the [ENTER] key and pressing a note on the keyboard of the TRITON Le, you can perform the following input operations.

- Input note number values or velocity values
- Select “KEY” in GLOBAL 5.1: DKit, SEQ 5.1: RPPR, RPPR Setup page

[ENTER] key + [LOCATE] key

- In Sequencer mode, set the current location as the “Location” (equivalent to the Utility menu command “Set Location”)

Appendices

Troubleshooting

If you experience problems, refer to the relevant item and take the appropriate measures.

Power does not turn on

- Is the AC/AC power supply connected to an outlet? [PG p.12](#)
- Is the [POWER] switch turned on?
Turn on the rear panel [POWER] switch.

The power is turned on, but nothing is shown in the LCD screen.

The TRITON Le functions normally when you play the keyboard or perform other operations.

- Due to changes in the surrounding temperature, the LCD screen may on rare occasions be difficult or impossible to read. If this occurs, perform the following procedure. ([PG p.125](#))
 - ① Press the [EXIT] key three times, and press the [GLOBAL] key.
 - ② Hold down the [EXIT] key, and press the [REC/ WRITE] key.
 - ③ Rotate the [VALUE] dial to adjust the LCD screen.

The power is turned on, but the LCD screen does not display normally, or an error message is displayed. There is no sound when you play the keyboard, and the TRITON Le does not function normally.

- This type of problem may occur if a data writing operation to internal memory was not completed correctly, for example if the power of the TRITON Le was turned off while a program or other data was being written. If this occurs, use the following procedure to initialize the TRITON Le's internal memory.
 - ① Turn off the power.
 - ② Hold down the [MENU] key and the [9] key, and turn on the power.

The TRITON Le will be initialized, and data will be written into internal memory. While the data is being written, the LCD screen will indicate "Now writing into internal memory."

No sound

- Are connections made correctly to your amp, mixer, or headphones? [PG p.12](#)
- Is your amp or mixer turned on?

- Is Local Control turned on?
In GLOBAL 2.1: MIDI, check the "Local Control On" check box. [PG p.128](#)
- Is the [VOLUME] slider raised? [PG p.5](#)
- If there is no sound from the OUTPUT (INDIVIDUAL) 1, 2 jacks, make sure that "BUS Select (IFX/Indiv.Out Assign)" or "Bus Select" following the insert effect is set to 1, 2, 1/2. [PG p.108](#)
- If specific tracks in Sequencer mode do not sound, Make sure that the "PLAY/MUTE/REC" or "PLAY/MUTE" is set to PLAY. [PG p.67](#)
- Make sure that the "Status" is INT or BTH. [PG p.68](#)
- Are the "Key Zone" and "Velocity Zone" set so that sound will be produced when you play? [PG p.64](#)

Notes do not stop

- In PROG 2.1: Ed-Basic, select the Prog Basic page, make sure that the "Hold" check box is unchecked. [PG p.5](#)
- In GLOBAL 1.1: System, Foot page, make sure that "Damper Polarity" or "Foot SW Polarity" is set correctly. [PG p.126](#)

Noise or oscillation is heard

- When using the BPM/MIDI Sync function to control the delay time of an effect, noise may occur in the delay sound. This noise is due to discontinuities in the delay sound, and is not a malfunction.
- When using an effect on the external audio source being input from AUDIO INPUT 1 and 2, oscillation may occur depending on the type of effect or on the parameter settings. Please adjust the input level, output level, and effect parameters. You need to be particularly careful when using a high-gain effect.
- After a sample edit has been executed, or after a stereo sample has been recorded, a small noise may be heard. This has no effect on the audio data that was edited or sampled.

Effects are not applied

- Are the GLOBAL 1.1: System, Basic page "IFX Off," "MFX1 Off," or "MFX2 Off" settings checked? [PG p.122, 123](#)

- If you are in Combination, Sequencer, and master effects are not applied when you raise the “S1 (Send1 (MFX1))” or “S2 (Send2 (MFX2))” of the timbre/track, does “Return 1” or “Return 2” from the master effect need to be raised? PG p.47, 85
Alternatively, has “Send 1” or “Send 2” for each oscillator of the program used by the timbre/track been lowered? PG p.45, 84

note The actual send level is determined by multiplying the send setting of each oscillator in the program with the send setting of the timbre/track.

When you loaded data, a combination or song does not sound correctly

- In the dialog box from which you saved the data, did you check the check boxes for each item that you wanted to save? p.45
- In the dialog box when saving the data, did you check the check boxes for each item that you wanted to save? PG p.124
- Are the bank/number of the programs used by the song the same as when the song was created? PG p.124

Playback does not start when you press the [START/STOP] key in Sequencer mode

- Is the GLOBAL 2.1: MIDI, MIDI page “MIDI Clock” set to **Internal**? PG p.127

Can't record in Sequencer mode

- In the GLOBAL 1.1: System, Preference page, is the Memory Protect “Song” check box unchecked? PG p.125
- Is the GLOBAL 2.1: MIDI, MIDI page “MIDI Clock” set to **Internal**? PG p.127

Arpeggiator does not start

- Is the [ARP ON/OFF] key turned on (lit)?
- If the arpeggiator does not start for a combination or song, make sure that “Arpeggiator Run” is checked, and that an arpeggiator is selected for “Assign.” p.28, PG p.35, 81
- Is the GLOBAL 2.1: MIDI “MIDI Clock” parameter set to **Internal**? PG p.127
- If the [ARP ON/OFF] key does not respond in GLOBAL 6.1: Arp.Pattern, you may have moved here from Sampling mode or Media mode.

No sound when the [AUDITION] key is turned on

- The Audition function is available only in Program mode.
- If no sound is played when you turn on the [AUDITION] key in Program mode, make sure that the PROG 2.1: Ed-Basic, Audition page parameter “Audition Riff” has not been turned Off PG p.9

- If no sound is played when you turn on the [AUDITION] key in Sampling mode, check the following points.
Is a sample correctly assigned to the currently selected “Index”? PG p.87

RPPR does not start

- Is the SEQ 1.1: Play/REC “RPPR” setting checked? PG p.51
- Are “Assign,” “Pattern Select,” and “Track” set correctly? p.73, PG p.72
- If the GLOBAL 2.1: MIDI “MIDI Clock” parameter set to **Internal**? PG p.127

You converted GM/GS/XG format SMF data and played it in Sequencer mode, but it does not sound correctly

- Execute “GM Initialize” to initialize the settings. PG p.54
- Is GLOBAL 1.1: System, Preference page “Bank Map” set to **GM**? PG p.124
- Make sure that the “Status” is **INT** or **BTH**. p.68, PG p.62

Settings for oscillator 2 are not displayed

- Make sure that the PROG 2.1: Ed-Basic, Prog Basic page “Mode (Oscillator Mode)” parameter is set to **Double**. p.50, PG p.5

This instrument does not respond to incoming MIDI data

- Are all MIDI cables connected correctly? p.12, PG p.231
- Is the MIDI data being received on the channel on which it is being transmitted? PG p.127

This instrument does not respond correctly to incoming MIDI data

- Are the GLOBAL 2.1: MIDI, MIDI page MIDI Filter settings “Enable Program Change,” “Bank,” “Combi,” “Ctrl Change,” and “AfterT” each **checked**? PG p.128
- If you wish to receive MIDI exclusive messages, is the GLOBAL 2.1: MIDI, MIDI page MIDI Filter “Exclusive” item checked? PG p.129
- Does this instrument support the types of messages that are being sent to it?

Can't format SmartMedia; can't save/load data

- Are you using 3.3V SmartMedia or SmartMedia with ID? p.96

- Is the SmartMedia inserted correctly?
Insert the SmartMedia with the contacts facing upward..... [p.97](#)
- Does the SmartMedia allow data to be written?
A write protect sticker may have been affixed to prohibit writing.
Remove the write protect sticker, insert the SmartMedia correctly into the slot, and try the save or load operation once again. [p.97](#)

Pressing the [SAMPLING] key does not enter Sampling mode.

- Is the EXB-SMPL installed correctly? [PG p.253](#)

Cannot input sound

- Is the EXB-SMPL installed correctly? [PG p.253](#)
- Is your audio source connected to the AUDIO INPUT 1, 2 jacks? [p.34](#)
- Is the [LEVEL] knob raised?..... [p.34](#)
- Is the [MIC/LINE] switch set appropriately? [p.34](#)
- If there is no sound in Sampling mode, go to SMPL 1.1: Recording, select the Input/Pref page, and make sure that "Lv1" and "BUS" are set correctly. [p.34, PG p.93](#)
- If there is no sound in Program, Combination, or Sequencer modes, go to GLOBAL 1.1: System, select the Audio In page, and make sure that "Input1 Level," "Input1 BUS Select," "Input2 Level" and "Input2 BUS Select" are set correctly. [p.111, PG p.126](#)
- If sound is still not input even after you have set "Input 1 Level," "Input 2 BUS Select," "Input 2 Level," and "Input 2 BUS Select" in the GLOBAL 1.1: System, Audio In page, temporarily lower the "Input 1 Level" and "Input 2 Level," and then move to Program, Combination, or Sequencer mode. Turn return to Global mode, and make the settings once again. [p.111](#)

Cannot record a sample

- Are one or more SIMM modules installed? [PG p.253](#)
- Is there free memory area..... [PG p.118](#)
Select a different memory bank..... [PG p.90](#)
Delete unneeded samples..... [PG p.94](#)
Save important samples before deleting them. [PG p.94, 149](#)

The TRITON Le does not recognize when MO media has been exchanged, and does not correctly display the media information after the exchange.

- If you are able to switch the mode setting of your MO drive between DOS/V(PC/AT) and Mac settings, please use DOS/V(PC/AT) mode. For details on changing the mode of your drive, refer to the owner's manual for your MO drive.

- Use the Media mode Media Information page utility "Scan SCSI device" to remount the SCSI device.
- If your MO drive does not have a mode setting, or if the media exchange is not recognized even after you switch the mode, use the drive select button to select a different drive, and then re-select the MO drive.

Specifications and options

Specifications

System

HI (Hyper Integrated) synthesis system

Modes

Combination, Program, Sequencer, Global, Media, Sampling (if the separately sold EXB-SMPL option is installed)

Tone generator

HI (Hyper Integrated) synthesis system

Polyphony: 62 voices (62 oscillators) in single mode
31 voices (62 oscillators) in double mode

Filters: 24 dB/oct LPF with resonance
12 dB/oct LPF + HPF

Alternate modulation function

Waveform memory

32 Mbyte PCM ROM
(425 multisamples, 413 drumsamples)

If the separately sold EXB-SMPL option is installed:
Sample data RAM (SIMM): 16 Mbyte included with the EXB-SMPL (expandable up to 64 Mbyte)

Effect section

1 insert effect (stereo in/out),
2 master effects (mono in/stereo out),
1 master EQ (3-band stereo), all usable simultaneously
89 effect types (available for insert effects or master effects)
Effect dynamic modulation function

Combinations/Programs

384 user memory combinations (384 preloads)
512 user memory programs (448 preloads)
128 + 9 drum ROM programs (GM sound map compatible)
383 audition riffs

Drum Kits

24 user drum kits (16 preloads)
9 ROM GM drum kits (GM2 sound map compatible)

Dual polyphonic arpeggiator

Use two arpeggiators simultaneously
(Combination, Sequencer modes)
5 preset arpeggio patterns
216 user arpeggio patterns (200 preloads)

Sequencer

16 timbres, 16 tracks + 1 master track
Maximum capacity: 200,000 notes
Resolution ♩ / 192
200 songs
20 cue lists
150 preset patterns, 100 user patterns (for each song)
16 preset / 16 user template songs
Supports TRITON Le format and SMF (formats 0 and 1)

RPPR (Realtime Pattern Play/Recording) function
(One set is available for each one song)

Media mode

Load, save, utility
Data filter function (save/load MIDI exclusive data)
Loading from CD-ROM (ISO 9660 level1) is supported (if the separately sold EXB-SMPL option is installed)
Combinations, programs, drum kits, user arpeggio patterns (.PCG) created on the TRITON/TRITON Pro/TRITON ProX or the TRITON-Rack can be convert-loaded.
Songs (.SNG) created on the TRITON/TRITON Pro/TRITON ProX can be convert-loaded.

Sampling (if the separately sold EXB-SMPL option is installed)

48 kHz, 16 bit linear
Maximum sample data memory capacity 64 Mbyte (with SIMM expansion)
4000 samples, 1000 multisamples
(128 indexes for each multisample)
Time Slice, Time Stretch, and various other editing functions
Able to load AIFF, WAVE, AKAI (S1000/3000), Korg format sample data can be loaded
Sample data can be exported in AIFF or WAVE formats

Keyboard

76 keys, 61 keys

Controllers

Joystick, [SW1]/[SW2] keys, REALTIME CONTROLS knobs [1]–[4] and [SELECT] key, [ARP ON/OFF] key

User interface

Graphical user interface: 240 × 64 pixel LCD display

Mode keys:

[COMBI], [PROG], [SEQ], [GLOBAL], [MEDIA], [SAMPLING]

Value controllers:

[VALUE] dial, [INC]/[DEC] keys, numeric keys ([0]...[9], [-], [./ HOLD])

Cursor keys [▲], [◀](-), [▼], [▶](+), [MENU/PAGE +/-] keys, [EXIT] key, [ENTER] key, [COMPARE] key, [F1]...[F8](T1/T9...T8/T16) key, [TIMBRE/TRACK] key

BANK keys:

PROG BANK: [A], [B], [C], [D], [GM]
COMBI BANK: [A], [B], [C]

SEQUENCER control keys:

[PAUSE], [REW], [FF], [LOCATE]

SEQUENCER/SAMPLING (if the separately sold EXB-SMPL option is installed) control keys:

[REC/WRITE], [START/STOP]

Other:

[AUDITION] key, [CATEGORY] key

Audio outputs

1/4" AUDIO OUTPUT (MAIN) L/MONO, R:

1/4" AUDIO OUTPUT (INDIVIDUAL) 1, 2

Output impedance 1.1 [k Ω]
(L/MONO is 550 [Ω] for mono)

Maximum output level

L/MONO, R: +12.0 [dBu]

(INDIVIDUAL)1,2: +11.6 [dBu]

Load impedance 100 [k Ω] or greater

1/4" AUDIO OUTPUT HEADPHONE

Output impedance 33 [Ω]

Maximum output level 36 [mW]

Load impedance 33 [Ω]

Audio inputs (if the separately sold EXB-SMPL option is installed)

AUDIO INPUT 1, 2

LEVEL [MIC/LINE] switch, [LEVEL] knob

Input impedance: 10 [k Ω]

Nominal level

LINE +3 [dBu] @ [INPUT] knob= min.

-30 [dBu] @ [INPUT] knob= max.

MIC -18 [dBu] @ [INPUT] knob= min.

-53 [dBu] @ [INPUT] knob= max.

Maximum level

LINE +13 [dBu] @ [INPUT] knob = min.

-20 [dBu] @ [INPUT] knob= max.

MIC -8 [dBu] @ [INPUT] knob= min.

-43 [dBu] @ [INPUT] knob= max.

Source impedance: 600 [Ω]

Control inputs

DAMPER (half-damper supported), ASSIGNABLE SWITCH/PEDAL

Other

MIDI IN, OUT, THRU

SmartMedia slot:

Usable media: 3.3V SmartMedia (4M-128Mbyte, including cards with ID)

AC power inlet, switch

Support for options

EXB-SMPL (one 16Mbyte 72-pin SIMM is included)

72-pin SIMM memory slots x 2 (for sample data RAM)

Dimensions (W x D x H)

61-key model: 1045.2 x 302.3 x 95.3 (mm)

76-key model: 1257.6 x 302.3 x 95.3 (mm)

Weight

61-key model: 7.8kg

76-key model: 9.2kg

Power consumption:

12W (if the EXB-SMPL option and two 32Mbyte SIMM are installed)

Included items:

AC/AC power supply 9VAC 3.0A

Options

Expansion board

EXB-SMPL Sampling upgrade

Expression/volume pedal:

XVP-10 EXP/VOL pedal

Foot controller:

EXP-2

Damper pedal:

DS-1H

Pedal switch:

PS-1

Other:

MIDI cable

* Appearance and specifications of this product are subject to change without notice. (Aug/01)

Index

Numerics

10's HOLD 21

A

ADC OVER!..... 34, 38

After Touch..... 25

After touch curve..... 114

Alternate Modulation .. 1, 23, 55, 61

Amp EG 53

Amplifier..... 53

Arpeggiator 26, 61

Assign..... 101

Gate..... 6

Key Sync. 28

Length of each note 27, 100

Length of the arpeggio note. 104

Link, Combination..... 102

Link, Program 101

Octave..... 100

on/off 26, 99, 101

Order 100

Range..... 100, 101

Strength of notes 27

Synchronization 107

Tempo 6, 27, 101

Timing 100

Velocity 6, 100

Arpeggio pattern 99

Assignable Foot Pedal..... 25

Assignable Foot Switch..... 25

ASSIGNABLE Pedal..... 113

ASSIGNABLE PEDAL jack 8

ASSIGNABLE Switch..... 113

ASSIGNABLE SWITCH jack..... 9

Assigning a name 43

AUDIO INPUT... 4, 9, 13, 34, 38, 83,

84, 85, 108, 110, 111, 117, 119, 121

AUDIO OUTPUT..... 2, 8, 12

Audition function 7

Audition riff 7

Auto pan 53

Auto sampling 85

B

BANK keys 7

Base key..... 89

Bit resolution 83

BPM 59, 88

BPM Adjust function..... 82

Broken chord 26

BUS Select

AUDIO INPUT 111

Combination, Sequencer 110

Program 108

Sampling..... 85

C

Cat. HOLD (Category Hold) 21

Category 7

Category Hold 15

Drumsample 94

Check box 10

CLIP! 38

COMBI BANK 7

Combination 1, 22, 32, 56

Effect 108

Organization 56

Compare function

Combination 57

Program 49

Sequencer 77

Connection

AC/AC power supply..... 12

Audio equipment 12

Audio input..... 13

Damper pedal 13

Foot switch 13

MIDI equipment/computer ... 13

Pedal..... 13

Constant Pitch..... 91

Continue sounding 104

Controller 23

Copy Key Setup..... 94

Create Control Data 80

Crossfade Loop..... 82

Cue List..... 19, 62, 71

Current page 10

Cutoff frequency 24, 52

D

Damper effect..... 13

DAMPER jack 9

Data dump 41, 46

Data filer 116

Decay Time..... 31

Demo song 18

Detune sound..... 50

Dialog..... 11

Dmod 111

Double..... 49, 50, 53

Drum kit 93, 94

Dual arpeggiator 2, 101

Dynamic Modulation..... 1, 61, 111

E

Edit

Combination..... 56

Pattern edit..... 70

Program..... 48

Song edit..... 70

Track edit 70

Edit Buffer 43

Edit cell..... 7, 10, 15

Effect

Combination, Sequencer 108

Program..... 108

Sampling 108

EG..... 51

Amp (Amplifier) EG..... 53

EG-INTENSITY 24

EG-RELEASE..... 24

Filter EG 52

Pitch EG..... 51

Event Edit..... 16, 80

EXB-SMPL..... 1, 2, 9, 41, 82

Excl Group (Exclusive Group).... 95

[EXIT] key 7

External media 98

External SCSI storage media 96

F

Filter EG 52

Filter Modulation..... 52

Filter Type..... 52

Foot pedal 25

Foot switch..... 9, 13

Force OSC Mode 58

Format 96

Front panel..... 5

Function button..... 10

G

Global 44, 93

GM2 3

Grid 88

Guitar input 84

H

HI (Hyper Integrated) 1

High Multisample, Low

Multisample..... 49

High pass filter 52

I

IFX Balance 31

Index.....35, 36, 82, 84, 87, 88, 89,
90, 92
(INDIVIDUAL) 1, 2.....8
Input setting38
Insert effect.....54, 60, 108
 Combination, Sequencer110
 Program109
 Sampling.....85, 110

J

Joystick.....5, 23

K

Key Sync.28, 100
Key Zone.....56, 59
Keyboard & Index89
Keyboard crossfade.....57
Keyboard input.....16
Keyboard Track52, 53
.KMP file98
.KSC file98

L

Layer.....57, 59
LCD screen6, 10, 116
LCD screen messages when
 separately sold options are
 installed.....17
Level
 AUDIO INPUT111
 Program53
Level meter.....38
LFO.....51, 54
Link.....82
 Combination.....102
 Program101
Load
 Data97
 Demo data18
 Preload data47
 RPPR.....30
Lock function23
Loop.....39
 Sample.....88
 Song.....64
Loop the playback.....38
 Song.....61
Low Pass & High Pass51
Low pass filter.....52
Low Pass Resonance51
LPF CUTOFF.....24

M

(MAIN) L/MONO, R.....8
Manual sampling.....85

Master effect.....109
 Combination, Sequencer110
 Program109
 Sampling110
Master EQ.....108
 Combination, Sequencer110
 Program.....109
 Sampling110
Master track62
Memory protect.....42, 77
[MENU PAGE +/-] key7
MIDI Channel
 Combination58
 Program.....48
MIDI Clock.....27, 80, 100, 107
MIDI connector9, 13
MIDI data file.....46
MIDI filter60
MIDI pitch bend data51
Mode (REC Mode)38
Mode (Sample Mode).....88, 89
Monaural source86
Monophonic.....49, 58
Multisample.....1, 35, 36, 37, 49,
 83, 93

N

Note Number.....25

O

Octave23, 27, 31, 59
 Arpeggiator.....100
on/off
 power17
Organization
 Combination56
 Program48
 Sampling83
 Sequencer62
Original scale114
OSC Select58
Oscillator49
Oscillator Mode.....93

P

Page menu.....11
Pan
 AUDIO INPUT111
 Combination57
 Drum kit95
 Program53
 Sampling85
 Sequencer68
Pattern.....62
Pattern Assignable30
.PCG file.....98
Pedal connection8

Pitch23, 50
 Combination.....59
 Drum kit.....93, 94
 Program49, 50, 51, 55
 Sampling35, 82, 89, 90, 91
 Sequencer.....61, 81
Pitch BPM Adj.91
Pitch EG.....51
Pitch Offset104
Pitch Stretch.....31
Playback pitch50, 59
Polyphonic.....49, 58
Portamento51, 58
Preload data.....19, 41, 47
PRELOAD PCG19
Preset data41
Preset pattern62
PROG BANK.....7
Program1, 29
 Effect.....108
 Organization.....48

Q

Quantize.....65

R

REALTIME CONTROLS5, 24,
 25, 27, 28, 31, 50, 58, 115
Realtime recording15, 78
 Auto punch-in79
 Loop All Tracks.....79
 Manual punch-in78
 Multi80
 Overdub78
 Overwrite.....78
 Pattern80
Rear panel8
Recording (Sample)
 Auto34
 Manual38
Recording (Song)
 Arpeggio pattern65
 Bass track64
 Pattern78
 Track.....78
Recording level34, 38
Rename.....43
Resolution64, 75, 100
Resonance52
RESONANCE/HPF5, 24
Restoring the factory settings47
REVERT10
Riff (phrase).....7
ROM drumsample.....94

Routing			
AUDIO INPUT.....	111		
Combination, Sequencer.....	110		
Program	108		
Sampling	110		
RPPR.....	2, 30, 61, 62, 74, 80, 118		
S			
Sample	36, 83		
Recording.....	34		
Save.....	90		
Sampling	84		
Effect.....	108		
Organization.....	83		
Sampling frequency	83		
Save.....	41, 45, 46, 96, 98		
Scale	59, 114		
Scroll bar	11		
SCSI connector	9		
Select			
10's HOLD			
Combination	22		
Program.....	21		
Arpeggio pattern	27		
Category			
Combination	22		
Program.....	21		
Combination.....	22		
Combination bank.....	22		
Combination number.....	22		
Page	14		
Parameter.....	15		
Program	20		
Program bank.....	20		
Program number	20		
Tab	15		
Select by Category	21		
Selecting a tab.....	15		
Selecting mode	14		
Selecting parameter	15		
Send			
AUDIO INPUT.....	111		
Combination, Sequencer.....	110		
Program	109		
Sequencer.....	2, 3, 13, 18, 30, 61		
Effect.....	108		
Organization.....	62		
Setting a parameter	15		
Shortcuts	116		
Shutdown Keys.....	30		
SIMM.....	82		
Single	31, 49		
SmartMedia	96		
SmartMedia slot.....	5		
SMF (Standard MIDI File)	41, 98		
.SNG file.....	98		
Song	62		
Song data	77		
Split.....	57, 59		
Step.....	103		
Step recording.....	65, 80		
Stereo.....	86, 88		
Stereo source	86		
SW1, SW2	5, 23, 115		
Synchronization			
Arpeggiator	107		
System exclusive data.....	41, 98		
T			
Tab	10		
Template Song	61, 63		
Tempo			
Arpeggiator	101		
Song.....	64		
Text dialog box	11		
Three elements of sound	49		
Timbre.....	56, 57, 58, 59		
Time Slice	82, 91		
Time Stretch	82		
Tone.....	5, 23, 49, 51, 55, 104		
Sound at the specified pitch ..	105		
Track Play Loop.....	64		
Track status	77		
Transpose	59		
Tremolo/auto-pan	51		
Truncate.....	40, 91		
Tuning.....	113		
U			
Use DKit Setting	95		
User arpeggio pattern.....	29, 103		
Chordal pattern	105		
Drum pattern	105		
Melody.....	105		
User pattern	62		
User template song	61		
Utility menu	10		
V			
VALUE controller	6, 10, 11, 15		
Velocity	25, 57, 114		
Velocity crossfading.....	60		
Velocity curve	114		
Velocity drumsample			
switching	94		
Velocity multisample			
switching	49		
Velocity SW L→H	50		
Velocity switch	57, 60		
Velocity zone.....	60		
Vibrato effect.....	51		
Volume	5, 17, 23, 31, 33, 49, 51, 53, 57, 58		
Combination.....	58		
Sampling	84		
Sequencer	68		
W			
Wah effect	52		
Write	7, 8, 29, 31, 33, 41, 42, 48, 56, 93		
Z			
Zero (Use Zero)	39, 88		
Zero crosses	88		
ZOOM	88		