

# *micro* X

**SYNTHESIZER / CONTROLLER**

## Operation Guide



HYPER INTEGRATED  
SYNTHESIS SYSTEM

# KORG

---

# Precautions

## Location

Using the unit in the following locations can result in a malfunction.

- In direct sunlight
- Locations of extreme temperature or humidity
- Excessively dusty or dirty locations
- Locations of excessive vibration
- Close to magnetic fields

## Power supply

Please connect the designated AC adapter to an AC outlet of the correct voltage. Do not connect it to an AC outlet of voltage other than that for which your unit is intended.

## Interference with other electrical devices

Radios and televisions placed nearby may experience reception interference. Operate this unit at a suitable distance from radios and televisions.

## Handling

To avoid breakage, do not apply excessive force to the switches or controls.

## Care

If the exterior becomes dirty, wipe it with a clean, dry cloth. Do not use liquid cleaners such as benzene or thinner, or cleaning compounds or flammable polishes.

## Keep this manual

After reading this manual, please keep it for later reference.

## Keeping foreign matter out of your equipment

Never set any container with liquid in it near this equipment. If liquid gets into the equipment, it could cause a breakdown, fire, or electrical shock.

Be careful not to let metal objects get into the equipment. If something does slip into the equipment, unplug the AC adapter from the wall outlet. Then contact your nearest Korg dealer or the store where the equipment was purchased.

## THE FCC REGULATION WARNING (for U.S.A.)

This equipment has been tested and found to comply with the limits for a Class B digital device, pursuant to Part 15 of the FCC Rules. These limits are designed to provide reasonable protection against harmful interference in a residential installation. This equipment generates, uses, and can radiate radio frequency energy and, if not installed and used in accordance with the instructions, may cause harmful interference to radio communications. However, there is no guarantee that interference will not occur in a particular installation. If this equipment does cause harmful interference to radio or television reception, which can be determined by turning the equipment off and on, the user is encouraged to try to correct the interference by one or more of the following measures:

- Reorient or relocate the receiving antenna.
- Increase the separation between the equipment and receiver.
- Connect the equipment into an outlet on a circuit different from that to which the receiver is connected.
- Consult the dealer or an experienced radio/TV technician for help.

Unauthorized changes or modification to this system can void the user's authority to operate this equipment.

## CE mark for European Harmonized Standards

CE mark which is attached to our company's products of AC mains operated apparatus until December 31, 1996 means it conforms to EMC Directive (89/336/EEC) and CE mark Directive (93/68/EEC).

And, CE mark which is attached after January 1, 1997 means it conforms to EMC Directive (89/336/EEC), CE mark Directive (93/68/EEC) and Low Voltage Directive (73/23/EEC).

Also, CE mark which is attached to our company's products of Battery operated apparatus means it conforms to EMC Directive (89/336/EEC) and CE mark Directive (93/68/EEC).

- 
- Apple, Mac and Audio Units are trademarks of Apple Computer, Inc., registered in the US. and other countries.
  - Windows XP is a registered trademark of Microsoft Corporation in the U.S. and other counties.
  - VST is a trademark of Steinberg Media Technologies GmbH.
  - RTAS is a registered trademark of Avid Technology, Inc., or its subsidiaries or divisions.
  - All other product and company names are trademarks or registered trademarks of their respective holders.

---

Thank you for purchasing the Korg microX Synthesizer/Controller. To help you get the most out of your new instrument, please read this manual carefully.

## About this manual

---

### The owner's manuals and how to use them

The microX come with the following owner's manuals.

- Operation Guide
- Parameter Guide (included in the CD-ROM)

### Operation Guide

Please read this first. It explains the names and functions of each part of the microX, how to make connections, basic operation, an overview of each mode, and how to edit sounds. This guide also explains the arpeggiator function, effects, and drum kits.

The Operation Guide also contains troubleshooting information, and supplemental information such as specifications.

### Parameter Guide

The Parameter Guide contains explanations and other information regarding the operations of the parameters and settings on the microX.

The explanations are organized by mode, and page. Explanations and other information on the effects and their parameters are also provided for each effect.

Refer to this guide when an unfamiliar parameter appears in the display, or when you need to know more about a particular function.

---

### Conventions in this manual

#### Abbreviations for the manuals OG, PG

In the documentation, references to the manuals are abbreviated as follows.

**OG:** Operation Guide

**PG:** Parameter Guide

#### Procedure steps 1. 2. 3. ...

This indicates the steps of a procedure.

#### Symbols , , Note

These symbols respectively indicate a caution, a MIDI-related explanation, a supplementary note.

#### Example screen displays

The values of the parameters shown in the example screens of this manual are only for explanatory purposes, and may not necessarily match the values that appear in the LCD display of your instrument.

#### MIDI-related explanations

**CC#** is an abbreviation for Control Change Number.

In explanations of MIDI messages, **numbers in square brackets [ ]** always indicate hexadecimal numbers.

# Table of Contents

Precautions.....	ii	<b>Simple program editing .....</b>	<b>43</b>
<b>About this manual .....</b>	<b>iii</b>	Performance Edit.....	43
<b>Quick Start .....</b>	<b>1</b>	REALTIME CONTROLS [1], [2], [3], [4], [SELECT] .....	43
Setup .....	1	Saving your edits.....	45
Playing programs and combinations .....	2	<b>Detailed Editing with Programs .....</b>	<b>46</b>
Listening to the demo songs.....	8	Before you begin editing.....	46
<b>Introduction .....</b>	<b>9</b>	Basic oscillator settings.....	48
<b>Main features .....</b>	<b>9</b>	Using LFOs and Envelopes (EGs).....	50
<b>Front and rear panel .....</b>	<b>11</b>	Using Alternate Modulation .....	51
Front panel.....	11	Controlling Pitch.....	52
Rear panel.....	14	Using Filters.....	53
Objects in the Display and their functions .....	15	Using the Amp section.....	55
<b>Basic Information.....</b>	<b>17</b>	Effects.....	56
About the microX' modes.....	17	<b>Playing and Editing Combinations...57</b>	
Basic operations.....	19	<b>Playing combinations .....</b>	<b>57</b>
<b>Setup.....</b>	<b>23</b>	Selecting combinations.....	57
<b>Turning the power on/off.....</b>	<b>23</b>	Using Controllers .....	59
Connecting the AC adapter .....	23	<b>Simple combination editing .....</b>	<b>60</b>
Turning the power on.....	23	Changing the programs within the Combination .....	60
Turning the power off.....	24	Adjusting a timbre's pan and volume .....	60
<b>Connections.....</b>	<b>25</b>	REALTIME CONTROLS [1], [2], [3], [4], [SELECT] .....	61
Basic connections.....	25	Saving your edits.....	61
Connecting a damper pedal, foot switch, or foot pedal.....	26	<b>Detailed Editing with Combinations .....</b>	<b>62</b>
Connecting a computer .....	27	Before you begin editing.....	62
Connecting MIDI devices .....	35	Selecting a program for each timbre .....	63
<b>Playing and Editing Programs .....</b>	<b>37</b>	Status and MIDI settings.....	63
<b>Playing programs.....</b>	<b>37</b>	Layers, Splits, and Velocity switches .....	64
Selecting programs .....	37	Altering Programs to fit within a Combination .....	66
Using Controllers .....	40	Effects.....	68

<b>Using and Editing Multi sets.....</b>	<b>69</b>	Saving a user arpeggio .....	104
<b>MIDI considerations .....</b>	<b>69</b>	Synchronizing the arpeggiator.....	105
Selecting a multi set .....	69	<b>Using Drum Kits.....</b>	<b>107</b>
Assigning a program to a track, and setting the volume and pan .....	70	What is a Drum Kit? .....	107
Copying the settings of a combination to a multi set .....	72	Before you start editing .....	107
What you can do in Multi mode .....	73	Editing Drum Kits.....	108
Using Controllers .....	74	Saving a drum kit.....	110
Altering Programs to fit within a Multi set....	74	<b>External control settings .....</b>	<b>111</b>
Layers, Splits, and Velocity Switches.....	75	Using external controls.....	111
Effects.....	75	External control setups.....	112
Saving your edits.....	75	Saving an external control setup.....	112
Control via MIDI.....	75	<b>Other functions .....</b>	<b>113</b>
<b>Effects settings .....</b>	<b>79</b>	Restoring the factory settings (Loading the preloaded data) .....	113
Effects in each mode .....	79	Assigning a name (Rename).....	114
Effect types.....	79	Assigning functions to REALTIME CONTROLS B-mode knobs [1]–[4].....	115
Effect settings for a program .....	81	Adjusting the display contrast .....	115
Effect settings in combination, and Multi.....	84	Tap tempo control.....	115
Dynamic modulation and BPM/MIDI Sync ..	85	<b>Appendices .....</b>	<b>117</b>
Saving edited effect settings .....	86	<b>Saving data .....</b>	<b>117</b>
Bypassing the insert effect or the master effects .....	86	Types of data that can be saved.....	117
<b>Global Mode .....</b>	<b>87</b>	About the Edit Buffer .....	118
How Global mode is structured.....	87	<b>Troubleshooting.....</b>	<b>119</b>
System setup 0: System .....	87	<b>Specifications and options .....</b>	<b>122</b>
MIDI-related settings 1: MIDI.....	89	Specifications .....	122
Creating user scales 2: User Scale.....	89	Operating requirements for connection to a computer .....	123
Setting category names 3: Category Name .....	90	Options .....	123
Saving the global settings .....	90	<b>MIDI Implementation Chart.....</b>	<b>124</b>
Drum kit 4: DKit, Arpeggiator 5: Arp.Pattern, External Control 6: Ext.Control settings.....	90	<b>Index .....</b>	<b>126</b>
<b>Arpeggiator settings.....</b>	<b>91</b>		
Arpeggiator features in Program mode.....	91		
The arpeggiator in Combination and Multi modes.....	95		
Creating a user arpeggio pattern.....	99		



# Quick Start

This Quick Start is provided for those who just want to get started trying out the sounds right away.

It explains how to set up the microX, how to select programs and control the sound, and how to listen to the demo songs.

After you've finished reading this Quick Start section, please also take a look at the full explanations that follow.

## Setup

**⚠** Make all your connections with the power off (on all units!). If you don't, you may damage your speaker system or damage your microX and/or other equipment. Please use caution.

1. Connect the included AC adapter.

Use only the AC adapter included with the microX. Do not use any other AC adapter.

2. Connect the microX to your audio monitoring system.

Using standard audio cables with 1/4" phone plugs, connect the microX' (MAIN OUTPUT) L/MONO and R output jacks to the input jacks of your mixer, amplified monitor speakers, or audio recording device.

If you're listening through headphones, connect them to the headphone jack located on the left front of the microX. The headphones produce the same signal as the (MAIN OUTPUT) L/MONO and R jacks.

### Connecting the AC adapter

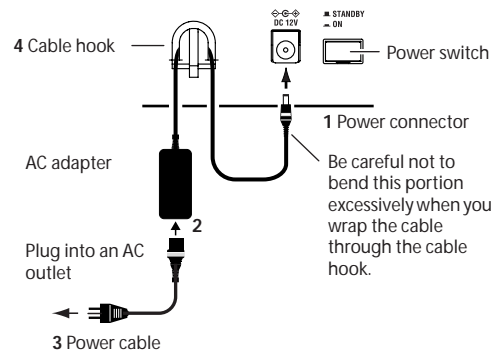

### Audio output device connections

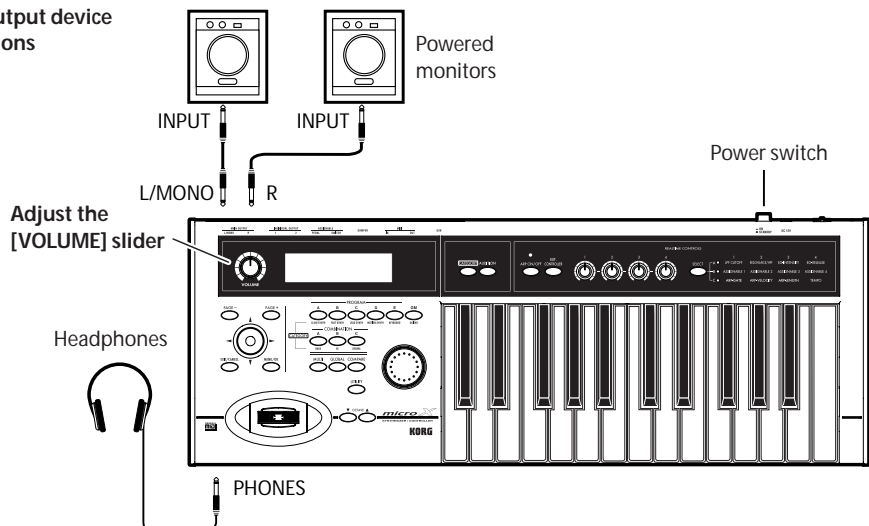

3. Turn the microX's [VOLUME] knob down (to the left).  
Turn on your audio monitor system and set the volume to a normal level.
4. Turn on the microX by pressing the power switch located on the rear panel.
5. Slowly raise the microX's [VOLUME] knob to an appropriate volume.

## Playing programs and combinations

By default, Combination mode will be selected when you turn on the power. Play the keyboard, and you will hear the sound of bank A combination number 000. A combination consists of up to eight programs that are split, zoned, layered or velocity-switched across the keyboard. A combination can also use up to two Arpeggiators simultaneously (a program can use only one Arpeggiator), letting you produce far more complex sounds than a single program.

Although you could simply continue selecting and playing different combinations, let's start by selecting and listening to the "basic" sounds of the microX – programs.

*Note:* If you don't hear any sound when you play the keyboard: Check the connections once again. Also make sure that the microX's VOLUME and the volume of your powered speakers or stereo amp are turned up appropriately.

## Selecting programs by bank and number

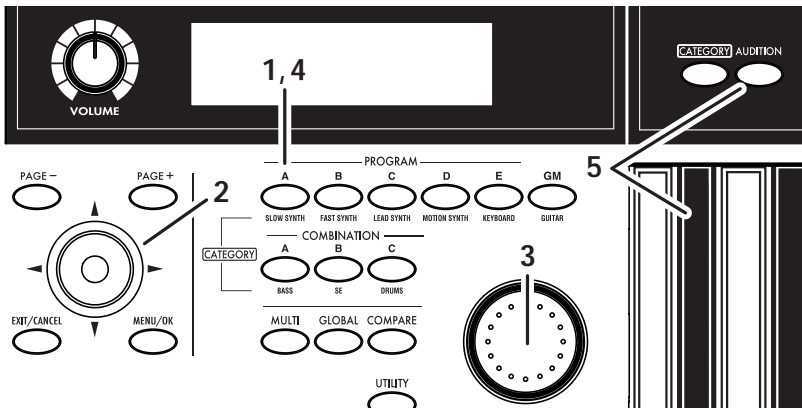

1. Press one of the PROGRAM [A]–[GM] buttons. (The button will light.)

You will enter Program mode, and the bank you specified will be selected. Notice that the upper line of the display indicates "PROG 0: Play" (mode name, page number and name).

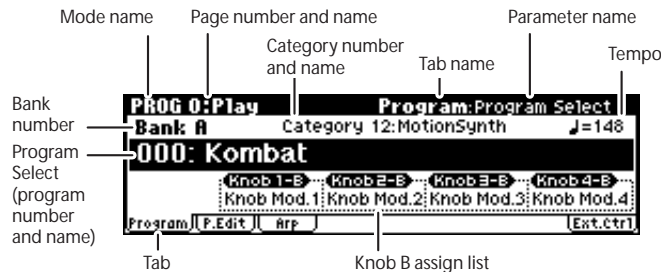

2. Make sure that "Program Select" (program number and name) is selected.  
If this is not selected, use the ClickPoint [▲][▼] to highlight the "Program Select" indication.



3. Turn the [VALUE] dial to select the program you want to play.  
 You can also press the center of the ClickPoint to highlight the field, then use [▲][▼] to select a program, and press the center to finalize your selection.
4. Press one of the PROGRAM [A]–[GM] button to switch banks.  
 When you select a different Bank, that button's LED will light, and the selected bank will appear in the left side of the display.  
 For example, to select bank B, press the PROGRAM [B] button. The [B] button will light, and the name Bank B will appear in the left of the display. The [GM] button operates differently from the other bank buttons. Each time you press this button, the bank will switch in the order of G → g(d) → G → g(d) ... etc.  
 The programs are organized into banks of 128 (except for g(d)). Select the desired bank, and then select a program number within that bank.
5. Play the keyboard to hear the program you selected.  
 While playing the keyboard, use the joystick, and realtime controllers to modify the sound. The result will differ depending on the program, so play the keyboard while operating these controllers to hear what they do. You can use the OCTAVE [▼][▲] buttons to change the pitch in steps of one octave.  
 For more about the controllers, see "Using controllers to modify the sound" (p. 5).  
 You can also press the [AUDITION] button (it will light) and a riff (phrase) suitable for that program will play automatically.

### Using the [CATEGORY] and PROGRAM/COMBINATION buttons to select a category

The microX lets you choose programs from categories such as "synthesizer," "bass," or "drums."

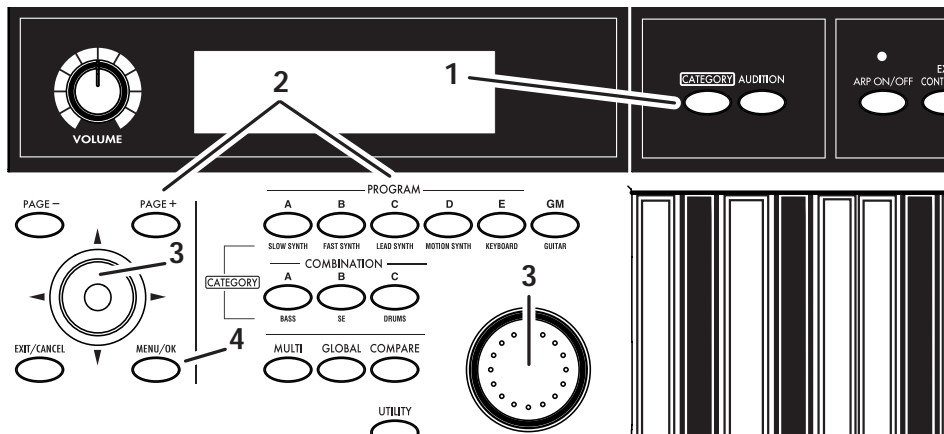

1. Press the [CATEGORY] button.  
 The category menu will appear.

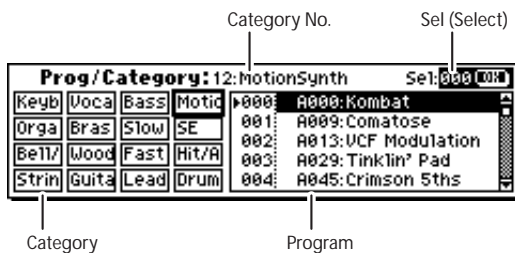

2. Press the PROGRAM or COMBINATION button for the desired category. The category you specify will be selected. (A category name is printed below each bank button.)

For example if you press the [CATEGORY] button and then press the PROGRAM [E] button, you'll be able to choose only from programs in the Keyboard category. The Keyboard category contains programs such as acoustic piano, and electric piano etc.

You can also use the [PAGE+]/[PAGE-] buttons to step through the categories one by one.

3. By using the [VALUE] dial or the ClickPoint [▲]/[▼] to select programs, you can step through the programs in the same category.
4. Press the [MENU/OK] button to confirm your selection. If you decide not to select a program, press the [EXIT/CANCEL] button.

## Selecting combinations by bank and number

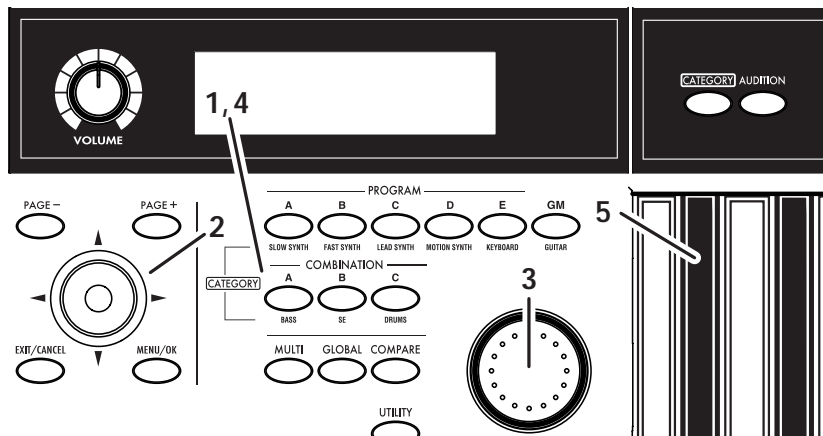

1. Press a COMBINATION [A]-[C] button. (The button will light.)

You will enter Combination mode, and the bank you specified will be selected. Notice that the upper line of the display indicates “COMBI 0: Play” (mode name, page number and name).

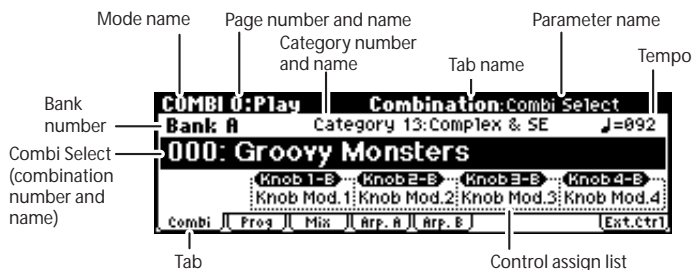

2. Make sure that “Combi Select” (combination number and name) is selected. If this is not selected, use the ClickPoint [▲]/[▼] to highlight the “Combi Select” indication.
3. Turn the [VALUE] dial to select the combination you want to play.
4. Press a COMBINATION [A]-[C] button to switch banks.

When you select a different Bank, the button’s LED will light, and the selected bank will appear on the left side of the display.

For example, to select bank B, press the COMBINATION [B] button. The [B] button will light, and the name Bank B will appear in the left of the display.

Combinations are organized into banks of 128. Select the desired bank, and then select a combination number within that bank.

5. Play the keyboard to hear the combination you selected.

While playing the keyboard, use the joystick, and realtime controllers to modify the sound. The result will differ depending on the combination, so play the keyboard while operating these controllers to hear what they do. You can use the OCTAVE [▼][▲] buttons to change the pitch in steps of one octave.

*Note:* You can't use the [AUDITION] button to play a riff (phrase) in Combination mode.

### Selecting combinations by category

In Combination mode you can select combinations by category just as in Program mode. For the procedure, see “Using the [CATEGORY] and PROGRAM/COMBINATION buttons to select a category” (p. 3).

### Using controllers to modify the sound

You can operate the microX's joystick, OCTAVE [▼][▲], and realtime controllers to add expressive variation to your performances.

#### Joystick

You can use the joystick to vary the pitch or adjust the depth of modulation. The actual result will depend on the program and combination, but these controllers are normally used to apply the following effects.

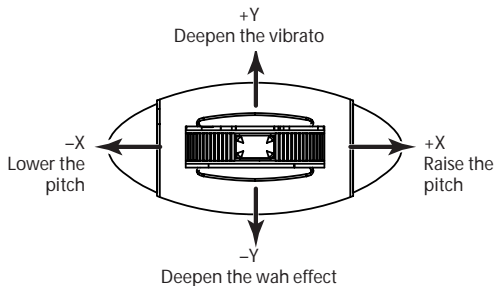

#### OCTAVE

You can use the OCTAVE [▼][▲] buttons to shift the pitches assigned to the keyboard in one-octave steps over a range of 3 octaves.



## REALTIME CONTROLS [1], [2], [3], [4], [SELECT]

Use the [SELECT] button to select realtime controller mode A/B/C, and use knobs [1]–[4] to control the tone, effects, MIDI control changes, and arpeggiator etc. while you perform. Use these knobs when you want to modify the sound while performing, or to make simple edits.

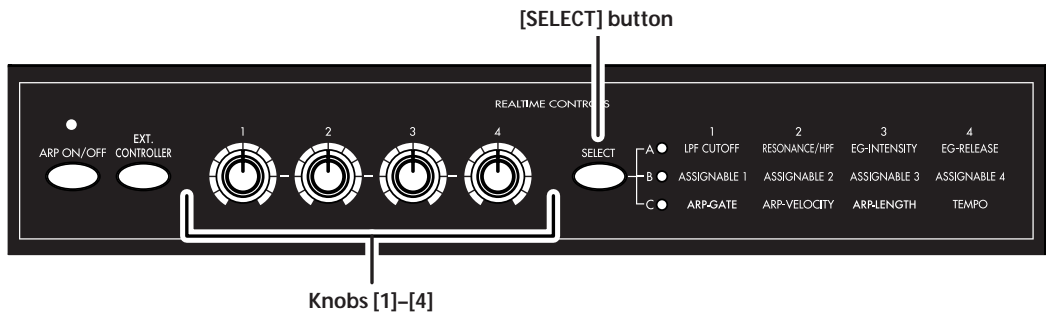

Here we'll explain how to use the realtime controllers in Program mode.

*Note:* We won't be using the External Control function, so make sure that the [EXT. CONTROLLER] button is dark. If it is lit, press the [EXT. CONTROLLER] button once.

1. Press one of the PROGRAM [A]–[GM] buttons. (The button will light.)
2. Choose "Program Select" (program number and name), and turn the [VALUE] dial to select the program that you want to control using the realtime controllers.
3. Press the REALTIME CONTROLS [SELECT] button to light the "A" LED located at the right of the button.
4. Turn knob [1] (LPF CUTOFF) to adjust the cutoff frequency of the low pass filter. When you adjust the cutoff frequency of the filter, the brightness of the sound will change. The effect will depend on the settings of the program parameters, but normally, rotating the knob toward the left will darken the sound, and rotating it toward the right will brighten it.
5. Turn knob [2] (RESONANCE/HPF) to adjust the resonance level of a low pass filter or the cutoff frequency of a high pass filter. The content that is controlled will depend on the filter type specified by the program. By adjusting the filter resonance level, you can increase or decrease the resonance level to add a unique character to the sound. Adjusting the cutoff frequency of the high-pass filter will modify the thickness of the sound from which the low frequency range has been filtered out.
6. Turn knob [3] (EG-INTENSITY) to adjust filter EG intensity (the depth at which the filter EG is applied). Rotating the knob will affect the depth of the filter EG. Normally, rotating the knob toward the left will make the filter EG apply less deeply, and rotating it toward the right will make the filter EG apply more deeply. Since the filter EG will operate based on the cutoff frequency of the filter, knobs [1] and [3] will work together to control the tonal changes produced by the filter.
7. Turn knob [4] (EG-RELEASE) to adjust EG release times of the filter and amp. This will determine the time from note-off until the sound disappears. When you adjust the knob, the release times of the filter EG and the amp EG will change. Normally, rotating the knob toward the left will shorten the release time, and rotating it toward the right will lengthen the release time.
8. Press the REALTIME CONTROLS [SELECT] button to light the "B" LED located at the right of the button.

In B-mode, effective functions for each of the preloaded programs and combinations are assigned to the knobs. This lets you use the knobs to control volume, portamento time, pan, filter and amp EG, pitch LFO, master effect send levels, and other parameters. Turn each knob to hear the result.

*Note:* The B-mode functions for the REALTIME CONTROLS [1], [2], [3], and [4] knobs can be viewed for Program mode in the 0: Play, Program page, and for Combination mode in the 0: Play, Combination page.

## Using the arpeggiator

As you selected and listened to various programs and combinations, you probably noticed that some of them began playing automatically. This is because of the arpeggiator.

The **arpeggiator** is a function that automatically generates arpeggios (the notes of a chord played individually in a rhythmic pattern). Most arpeggiators produce an arpeggio when you play a chord on the keyboard. In addition to this, the microX's arpeggiator is a polyphonic arpeggiator that is able to produce a variety of chordal transformations or phrases based on the pitch or timing of the notes you play on the keyboard. These functions let you use the arpeggiator to play a wide range of patterns including drum or bass phrases, and guitar or keyboard backing riffs. It is also effective to use the arpeggiator as part of the sound-creating process when creating subtly-moving pads, synth-sounds, or sound effects.

In Program mode you can use one arpeggiator.

In Combination mode and Multi mode you can use two arpeggio patterns simultaneously (dual polyphonic arpeggiator). This gives you a variety of possibilities, such as applying separate arpeggio patterns to a drum program and a bass program, or using splits or velocity to switch between arpeggio patterns.

Here we'll explain how to use the arpeggiator in Program mode.

## Using the realtime controllers to control the arpeggiator

1. Press one of the PROGRAM [A]–[GM] button. (The button will light.)
2. Choose "Program Select" (program number and name), and turn the [VALUE] dial. You will notice that the [ARP ON/OFF] button is lit for some programs. Select one of these programs, and play the keyboard; the arpeggiator will start playing.

Even for other programs, you can press the [ARP ON/OFF] button (the button will light) to turn on the arpeggiator. Play the keyboard to make the arpeggio start.

3. Press the REALTIME CONTROLS [SELECT] button to light the "C" LED located at the right of the button.
4. Turn the [4] (TEMPO) knob to change the tempo.
5. Turn the [1] (ARP-GATE) knob to change the duration of the arpeggiated notes.
6. Turn the [2] (ARP-VELOCITY) knob to change the level of the arpeggiated notes.
7. Turn the [3] (ARP-LENGTH) knob to change the length of the arpeggio pattern.

Changing the length of the arpeggio pattern will change the character of the pattern. This doesn't work for the preset patterns (UP, DOWN, ALT1, ALT2, and RANDOM).

## Changing the arpeggio pattern

The microX contains preset arpeggio patterns Preset-0 through Preset-4, and user arpeggio patterns U000–250.

1. Press the [PAGE+] button to access the PROG 0: Play, Arp. Play page.



2. Use the ClickPoint [◀][▶][▲][▼] to choose "Pattern," and use the [VALUE] dial to select an arpeggio pattern.
3. Play the keyboard and try out various arpeggio patterns.

## Listening to the demo songs

The microX contains demonstration songs.

Take a moment to listen to these demo songs to experience the diverse sounds and rich expressive potential of the microX.

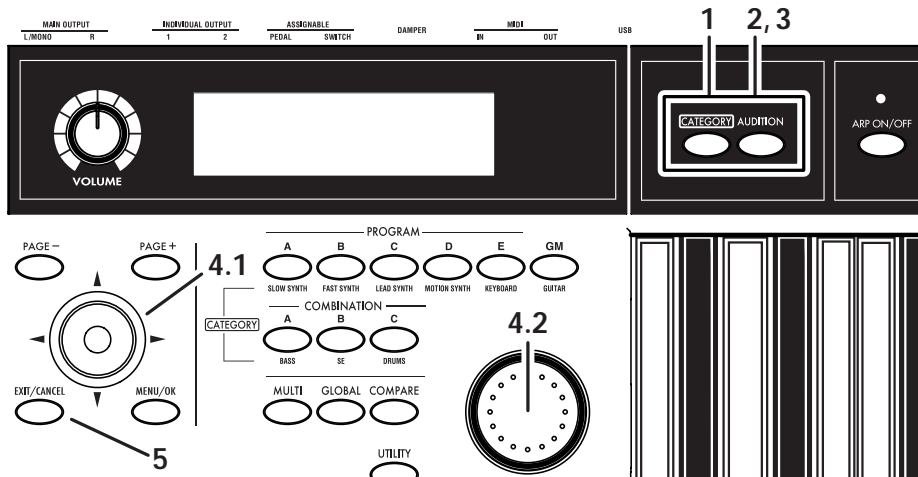

1. Hold down the [CATEGORY] button and press the [AUDITION] button.

The Demo Song Player page will appear.

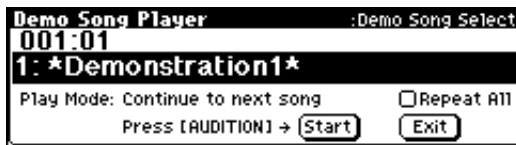

2. Press the [AUDITION] button to begin playback.
3. Press the [AUDITION] button once again to stop playback.
4. To select a song for playback, use the ClickPoint [▲][▼] to select the song name (“Demo Song Select”) and use the [VALUE] dial to change songs.
5. To exit the Demo Song Player page, press the [EXIT/CANCEL] button.  
You can also exit by pressing one of the PROGRAM [A]–[GM], COMBINATION [A]–[C], [GLOBAL], or [MULTI] buttons.

## Changing the play mode

- **You can play back the demo songs in succession or only one song at a time;** use the ClickPoint [◀][▶][▲][▼] to select “Play Mode” and use the [VALUE] dial etc. to change the setting.

**Continue to next song:** When the currently selected demo song finishes playing, the next demo song will play automatically.

**Stop at end of selected song:** When the currently selected demo song finishes playing, playback will stop.

- If you want all of the demo songs to continue playing repeatedly, use the ClickPoint [◀][▶][▲][▼] to select the “Repeat All” check box and then press the ClickPoint center to add a check mark.

*Note:* This is available only if “Play Mode” is set to Continue to next song.

This Quick Start section is just an introduction to introduce you to your new synthesizer. Please take the time to read the more in-depth sections of this manual that follow.

# Introduction

## Main features

---

### High-quality sound featuring the HI synthesis system

The microX Music Synthesizer features Korg's acclaimed HI (Hyper Integrated) synthesis system.

The **HI (Hyper Integrated) synthesis system** is a PCM tone generator system with extensive modulation and effect routing capabilities, as well as full digital signal processing that guarantees a rich, pristine sound.

#### Tone generator section:

- 64 MB of preset PCM ROM containing 642 multisamples and 929 drumsamples.
- The sampling frequency is 48 kHz, and the maximum polyphony is 62 voices.

#### Filter/synthesis section:

- 24 dB/oct Low Pass Resonance type or 12 dB/oct Low Pass & High Pass type filters can be used. A wide variety of filter effects can be achieved, from active sounds with aggressive resonance to subtle tones using a high pass filter.
- A broad range of editing parameters gives you control over every aspect of the sound.

#### Effect section:

- One insert effect (stereo-in/stereo-out), two master effects (mono-in/stereo-out), and a three-band master EQ (stereo-in/stereo-out) can all be used simultaneously. You can select from 89 types of effect algorithms, and edit them.
- Highly flexible effect routing is possible. Effects can also be routed freely to the individual outputs.

#### Alternate Modulation and Effect Dynamic Modulation:

- The synthesis section (filter etc.) provides Alternate Modulation functionality, and the effect section provides Effect Dynamic Modulation functionality. This allows you to freely apply modulation to parameters that affect the pitch, filter, amp, EG, LFO, effects etc.

- LFO and delay time parameters can be synchronized to MIDI clock/tempo. You can synchronize sounds or effects to the tempo of the sequencer or the arpeggiator.

---

### A great selection of 640 programs

In the Program mode, the microX provides 640 user programs, plus 128 programs + 9 drum sets for GM compatibility.

When shipped from the factory, it is loaded with high-quality programs that cover a wide range of musical needs.

### Programs using multisamples that provide a broad range of sounds

Based on 642 different multisamples that deliver a broad range of sounds ranging from acoustic instruments such as piano, guitar, and trumpet, to synthesizer sounds or sound effects (oscillator), the preset programs provide a rich variety of editable parameters (filter and amp), effects, and arpeggiators.

### Drum programs that support any style of rhythm part

Based on 40 user drum kits and nine GM2-compatible ROM drum kits, and taking full advantage of numerous editable parameters, effects, and arpeggiators, the microX provides a great selection of preset programs for any style of music.

The drum kits that are the basis of each drum program allow you to freely map any of the 929 drum or percussion sounds to each note of the keyboard. You can also create your own drum kits, and even specify filter and amp settings, effect settings, and individual audio output routings for each separate key.

---

### 384 different combinations let you freely combine programs

The microX provides 384 user combinations. The factory settings contain a wide variety of Pre-loaded combinations.

A combination allows you to use layers, splits, or velocity switching etc. to combine up to eight programs together with the effects and the two arpeggiators, in order to create complex sounds that could not be produced by a program. You can also create combis that include external tone generators.

---

### Effects that can creatively manipulate the sound or generate subtle ambience

The microX's effects can be used in many ways, ranging from manipulating the sound dramatically to creating spacious reverberation. (see p. 9 "High-quality sound featuring the HI synthesis system")

---

### 4 channel audio outputs

In addition to the (MAIN OUTPUT) L/MONO and R main stereo audio outputs, microX provides two individual audio outputs, for a total of four channels of audio output. The sound from each oscillator, drum, timbre/track, or insert effect can be routed freely to any output.

---

### Multi mode plays multiple tracks of data from an external sequencer

In Multi mode, the microX can operate as a 16-track MIDI multi-timbral sound module, receiving multiple tracks of performance data from an external sequencer or similar device. Since you can use the effects and the two arpeggiators as well, the microX will also function as a more advanced sound module.

You can create, save and recall numerous Multi sets in the microX and it also supports GM (General MIDI System Level 1), making it easy to use as a sound module for a desktop music system.

---

### Dual polyphonic arpeggiator

Five preset arpeggio patterns (UP, DOWN, ALT1 ALT2, RANDOM) and 251 user arpeggio patterns are provided. With the factory settings, these contain a wide variety of preload arpeggio patterns.

In addition to providing conventional arpeggiator functions, the polyphonic arpeggiator of the microX can respond to the pitches or timing of your keyboard playing, and produce a diverse range of chords or phrases. This can be used to play a variety of drum phrases, bass phrases, or guitar and keyboard backing riffs. The arpeggiator

is also effective for use with subtly moving pads, synth sounds, or sound effects.

In Combination mode, and Multi mode, the microX provides dual polyphonic arpeggiators that can simultaneously play two arpeggio patterns. You can apply separate arpeggio patterns to drum and bass programs, or use keyboard splits or velocity to switch between arpeggio patterns for an even more dynamic performance.

---

### External control setups

You can assign twelve MIDI control changes to the REALTIME CONTROLS [1]–[4] knobs. The microX can hold 64 such sets of twelve control change assignments. You can use this capability to control a wide range of parameters in realtime, such as on the KORG Legacy Collection or other soft synthesizers, or the level and pan of your DAW (Digital Audio Workstation).

---

### Direct USB connection to your computer

The microX provides a convenient USB connector that allows single-cable connection to your computer, without requiring a MIDI interface or MIDI connectors. The microX supports Windows XP and Macintosh OS X 10.3 or later.

---

### microX Plug-In Editor supports editing from within your DAW software

The "microX Editor" is a stand-alone program that lets you edit the microX from your Macintosh or Windows computer.

On the other hand, the "microX Plug-In Editor" lets you edit the microX as a plug-in instrument from within a host application such as DAW (Digital Audio Workstation) software. It supports VST, Audio Units, and RTAS formats. Both editors are included with your microX.



# Front and rear panel

## Front panel

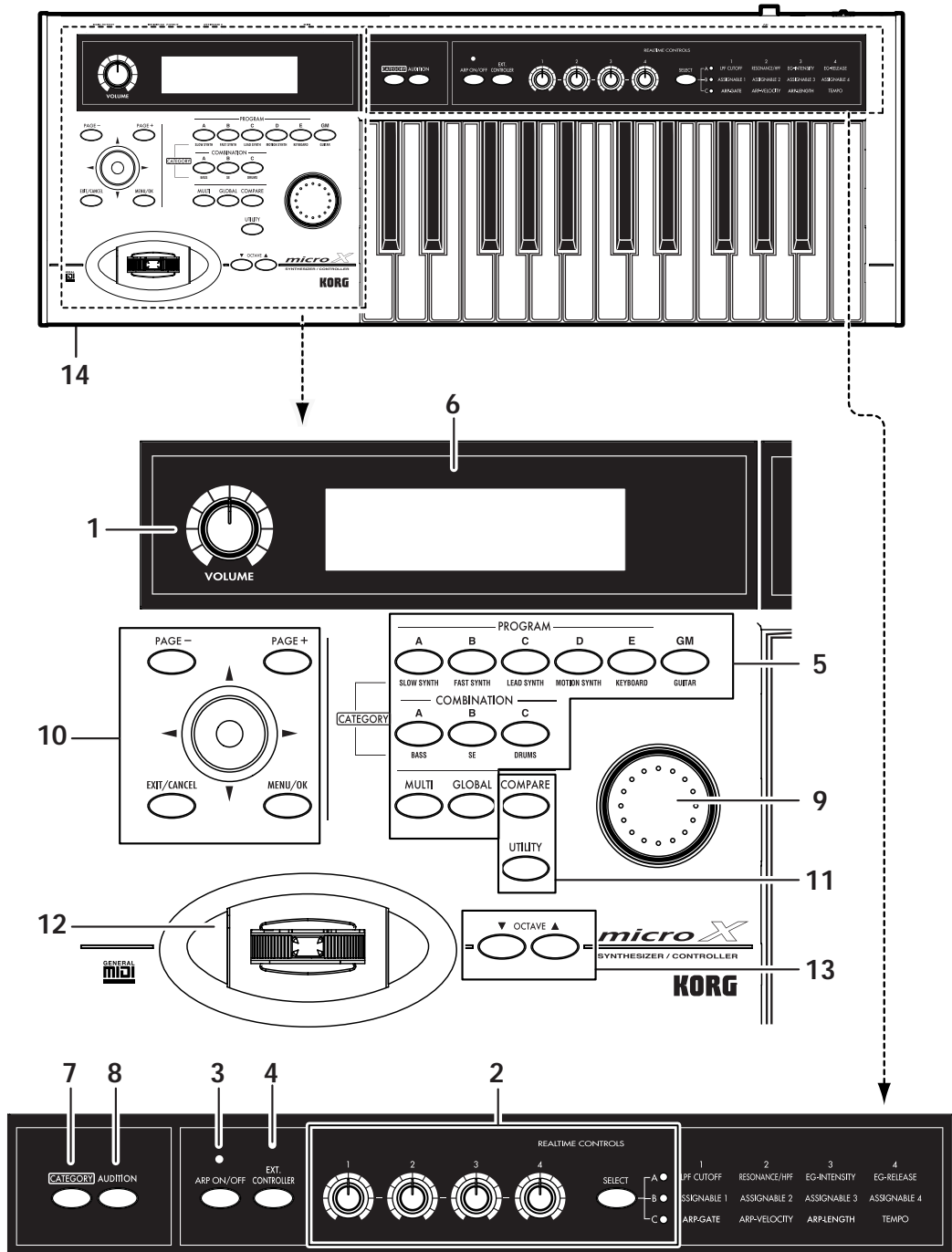

### 1. [VOLUME] knob

This adjusts the volume of the (MAIN OUTPUT) L/MONO, R jacks, as well as the volume of the headphone jack.

### 2. REALTIME CONTROLS

#### [SELECT] button

##### [1]–[4] knob

Use the [SELECT] button to choose one of the real-time controller modes - A/B/C - and use knobs [1]–[4] to control the tone, effects, MIDI control changes, and arpeggiator etc. while you perform. (☞p.43, 92)

When you turn the [EXT. CONTROLLER] button on (lit), External Control will be on, and the REALTIME CONTROLS [1]–[4] knobs will transmit MIDI messages to external MIDI devices. (☞p.111)

### 3. Arpeggiator

The microX's arpeggiator is a polyphonic arpeggiator.

#### [ARP ON/OFF] button

This button turns the arpeggiator on/off. When on, the button will light. (☞p.91)

The LED located above the [ARP ON/OFF] button blinks at quarter-note intervals of the tempo.

In **REALTIME CONTROLS C-mode**, you can use the **[1], [2], [3], and [4] knobs** to vary the arpeggio pattern in realtime.

### 4. External

You can use the REALTIME CONTROLS [1], [2], [3], and [4] knobs to transmit MIDI messages.

#### [EXT. CONTROLLER] button

This switches the external function on/off. When on, the button will light. (☞p.111)

When this is on, you can use the [SELECT] button to select the MIDI messages assigned to the knobs, and operate the REALTIME CONTROLS [1], [2], [3], and [4] knobs to transmit these MIDI messages to an external MIDI device.

### 5. MODE/BANK Select

Use these buttons to select banks and enter modes. The microX has four modes. (☞p.19)

#### PROGRAM [A], [B], [C], [D], [E], [GM] button

#### COMBINATION [A], [B], [C] button

#### [GLOBAL] button

#### [MULTI] button

### 6. Display

You can select a page, tab, or parameter in the display, and specify its value. (☞p.15)

### 7. CATEGORY

You can select programs, multisamples, combinations, timbre/track programs, effects, or drum samples by category.

#### [CATEGORY] button

Press this button to access the category menu, and choose a program etc. from the list. The category menu will appear if you have selected an appropriate mode, page, or parameter. (☞p.38, 45, 82, 108)

### 8. AUDITION, Demo Song Player

#### [AUDITION] button

In Program mode when you press the [AUDITION] button (the button will light), a riff (phrase) appropriate for the preloaded or preset program will play. (This is called the Audition function.) To stop auditioning, press the [AUDITION] button once again.

#### Demo song player

When you hold down the [CATEGORY] button and press the [AUDITION] button, the Demo Song Player page will appear.

Select a song and press the [AUDITION] button to begin playback. Press the [AUDITION] button once again to stop playback.

To exit from this mode, press the [EXIT/CANCEL] button. (☞p.8)

### 9. VALUE controller

The [VALUE] dial is used to set the value of the selected parameter. (☞p.20)

#### [VALUE] dial

## 10. PAGE, CURSOR

### [PAGE+][PAGE-] buttons

You can use these buttons to move forward or backward through the different tabs in a page.

By holding down the [MENU/OK] button and pressing these same buttons you can move forward or backward through the pages themselves, such as page 0, 1, 2, etc. (☞p.20)

While the category menu is displayed, you can use these buttons to step through the categories one by one. (☞p.38)

### ClickPoint

The ClickPoint is a multi-function controller.

You can move the ClickPoint in the ([◀][▶][▲][▼]) direction to select parameters. In addition, you can press directly down on the center of the ClickPoint (in toward the body of the instrument) to select an item in the display.

After selecting a parameter expressed as a numerical value etc., press the center of the ClickPoint; the value will be highlighted, and now you can use [▲][▼] to increase or decrease the value. To finalize the value, press the center once again.

If you press the [EXIT/CANCEL] button while pressing the ClickPoint center, the selected value will be reset to 0 or the minimum value.

You can also press the ClickPoint center to access a dialog box, to set the numerical value of an editable condition, or to turn a switch on/off. If you press the ClickPoint on the utility menu, page menu, or a text edit button (☞p.15), the selected command or page will appear. Pressing the ClickPoint center on a check box will switch the item on/off. Pressing the ClickPoint center on a button such as OK or CANCEL will confirm the corresponding choice.

### [MENU/OK] button

Press this button to access the page menu. (☞p.19)

By holding down the [MENU/OK] button and pressing the [PAGE+] button or [PAGE-] button, you can move forward or backward in steps of one page.

If a dialog box is open, this button will confirm the settings in the dialog box and close it. (This is the same function as the OK button.)

### [EXIT/CANCEL] button

When you are in a page other than 0 of each mode, you can press this button to move to page 0 of that mode.

If you press the [EXIT/CANCEL] button while pressing the ClickPoint center, the selected value will be reset to 0 or the minimum value.

When a dialog box is open, this button will cancel the settings made in the dialog box and close the dialog box (corresponds to the "Cancel"). If a Utility menu or page menu is open, pressing [EXIT/CANCEL] button will close the menu.

## 11. UTILITY, COMPARE

### [UTILITY] button

Press this button when you want to use the utility functions. (☞p.21)

### [COMPARE] button

Use this button when you wish to compare the sound of the program, combination or multi set that you are currently editing with the un-edited sound that was written into memory. (☞p.20)

## 12. JOYSTICK

This controls pitch or modulation, etc.

Move the joystick up/down or left/right (+Y, -Y, -X, +X) to control (☞p.40).

Various program parameters and effect parameters will determine what is controlled by the joystick.

## 13. OCTAVE

### OCTAVE [▼][▲] buttons

These buttons change the pitch range assigned to the keyboard over a  $\pm 3$  octave range in one-octave steps. (☞p.41)

## 14. Headphone jack

This 1/8" mini-stereo phone jack carries the same signal as the (MAIN OUTPUT) L/MONO, R jacks.

The headphone volume is controlled by the [VOLUME] knob.

## Rear panel

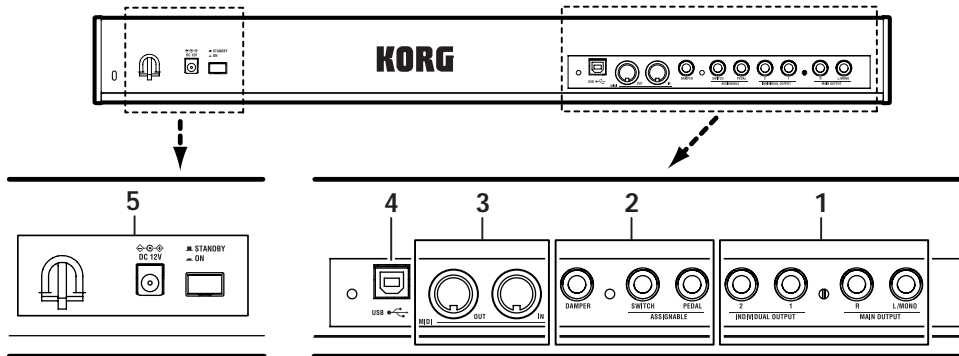

### 1. AUDIO OUTPUT

Connect these outputs to the input jacks of your amp or mixer. In addition to the (MAIN OUTPUT) L/MONO and R main stereo audio outputs, the microX provides two individual audio outputs. (☞p.25)

**MAIN OUTPUT L/MONO, R jack**  
**INDIVIDUAL OUTPUT 1, 2 jack**

### 2. PEDALS

You can connect a damper pedal, foot switch, and foot pedal to these jacks. This gives you a broader range of functions and effects to control. (☞p.26)

**ASSIGNABLE PEDAL jack**  
**ASSIGNABLE SWITCH jack**  
**DAMPER jack**

### 3. MIDI

MIDI lets you connect microX to computers or other MIDI devices, for sending and receiving notes, controller gestures, sound settings, and so on. (☞p.35)

**MIDI IN connector**  
**MIDI OUT connector**

### 4. USB

**USB connector**  
**(for connecting to computer)**

You can connect your computer to this connector. Using a single USB cable, your microX can send and receive MIDI information directly to and from a computer, without requiring a MIDI interface. (☞p.32)

### What is USB?

USB stands for **Universal Serial Bus**, and is an interface for transferring data between a computer, a keyboard and/or peripheral devices.

*Note:* The USB connector of the microX is only able to transmit and receive MIDI data.

### 5. Power supply

Be sure to see “Turning the power on/off” (☞p.23) and follow the correct procedure described there.

#### Power switch

This switch turns the power on/off.

#### AC adapter connector

Connect this to the included AC adapter.

⚠ Connections must be made with the power turned off. Please be aware that careless operation may damage your speaker system or cause malfunctions.

#### Cable hook

Use this to secure the cable of the included AC adapter. After connecting the AC adapter, fasten the cable around the hook located on the microX's rear panel so that the cable will not be pulled out inadvertently. Leave enough slack on the plug end so that you can disconnect it if you want to.

⚠ Be careful not to bend the base of the plug any more than necessary.

# Objects in the Display and their functions

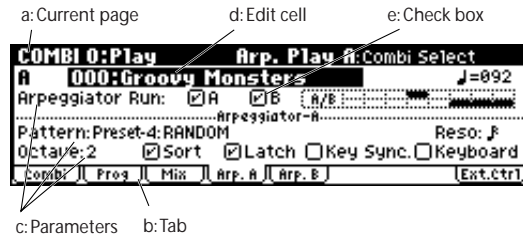

## a: Current page

This indicates the current page within the selected mode.

From the left, this area shows the mode name, page number: name, tab name, and the parameter name of the edit cell.

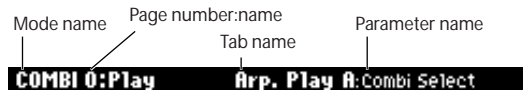

## b: Tab

Most pages are divided into two or more tabs. Use the [PAGE+]/[PAGE-] buttons to select a tab and view that page.

## c: Parameters

The parameters for various settings are displayed in the display. Use the ClickPoint [◀|▶][▲|▼] to select the desired parameter.

## d: Edit cell

When you use the ClickPoint [◀|▶][▲|▼], the selected **parameter** will be highlighted in the display. This area is called the **edit cell**, and your editing will affect the highlighted area. For details on how to edit the value, see “3. Selecting a parameter and editing the value” (p.20).

## e: Check box

Use the ClickPoint [◀|▶][▲|▼] to select a check box, and use the [VALUE] dial, the center of the ClickPoint to add or remove the check mark.

When checked, the parameter will function, when unchecked, the parameter will not function.

## \* Utility menu



When you press the [UTILITY] button in a page, the utility menu will appear. The utility menu contains commands that can be used in that page. The utility menu that appears will differ depending on the page that is selected.

For details on selecting and executing a utility command, see “4. Selecting and executing a Utility function” (p.21).

## \* Dialog boxes

When you select a utility menu command etc., a **dialog box** will open.

Use the ClickPoint [◀|▶][▲|▼] to select parameters. To enter a parameter value, use the [VALUE] dial, the ClickPoint [▲|▼]. To execute the utility command, press the [MENU/OK] button.

If you decide not to execute, press the [EXIT/CANCEL] button. The [EXIT/CANCEL] button is equivalent to “Cancel,” “Done,” or “Exit.”



## \* Text dialog box

Use the ClickPoint [◀|▶][▲|▼] to select a text button such as **G**, and press the center to open the text dialog box.

In this dialog box you can rename text (e.g., the name of a program, combination, or multi set). (p.114)



## \* Function buttons

Use the ClickPoint [◀|▶][▲|▼] to select one of these buttons and press the center to execute the following functions.



**\* Scroll bar**

This indicates that the list contains more selections or parameters than can be shown in the screen at one time. Use the ClickPoint [▲][▼] to move within the list.

Scroll bar



**\* Page menu**

In Combination, Program, Global, or Multi modes, pressing the [MENU/OK] button will display a list of the pages in that mode.

To select a page, use the ClickPoint [◀][▶][▲][▼] to select the desired page and press the center.

(see p. 19 “Using the page menu to move”)

When “Page Menu Style” = Icon

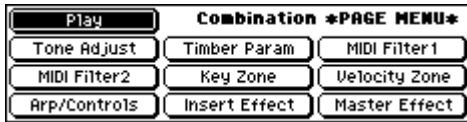

When “Page Menu Style” = List



Note: You can set “Page Menu Style” in the GLOBAL 0: System, Preference page.

**\* Other objects**

To use slider- or knob-shaped objects, use the ClickPoint [◀][▶][▲][▼] to select the desired item, and use the VALUE controllers to adjust the value.

Other types of objects are shown in the effect routing screen.

Slider

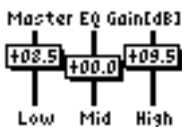

Knob



Routing

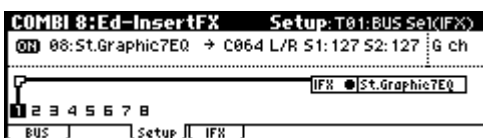

# Basic Information

## About the microX' modes

The microX has a wide range of capabilities; it lets you play programs/combinations, edit them, play the microX's sound generator using musical performance data from an external MIDI sequencer, and make settings that affect the entire microX, such as transposition and tuning. The largest unit used to organize these features is called a **mode**. The microX has four modes.

### Program mode

Programs are the basic sounds of microX. In Program mode, you can:

- Select and play Programs
- Edit Programs
  - Make detailed settings for oscillators, filters, amps, EGs, LFOs, effects, arpeggiator, etc.
- Create drum programs using drum kits (as created in Global mode)
- Play and control one Arpeggiator (☞p.43)

### Combination mode

Combinations are sets of up to 8 Programs that can be played simultaneously, letting you create sounds more complex than a single Program. In Combination mode, you can:

- Select and play Combinations
- Use microX as a 8-track multitimbral tone generator
- Edit Combinations
  - You can use the Tone Adjust function to make simple edits for the program of a timbre.
  - Assign Programs to each of the 8 Timbres, each with separate volume, pan, EQ, and keyboard and velocity zones; make settings for effects, and Arpeggiator. (☞p.60)
- Control and play up to two Arpeggiator

### Multi mode

You can use the microX as a 16-track multi-timbral sound generator.

The microX will receive GM or other performance data from an external MIDI sequencer, and play back this data.

- Select and playback Multi sets
- Edit Multi sets

You can use the Tone Adjust function to make simple edits for the program of a track.

Assign Programs to each of the 16 MIDI Tracks, each with separate volume, pan, EQ, and keyboard and velocity zones; make settings for effects, and two Arpeggiator (☞p.69)

### Global mode

Global mode lets you make overall settings for the entire microX, and edit arpeggiators, drum kits and external control sets. For instance, you can:

- Make settings that affect the entire microX, such as master tune and global MIDI channel
- Create user drum kits, arpeggiators, user scales and external control sets
- Rename program, and combination categories
- Set the function of the assignable pedals and assignable switches
- Make settings for the external control function. (☞p.111)
- Transmit MIDI System Exclusive data dumps

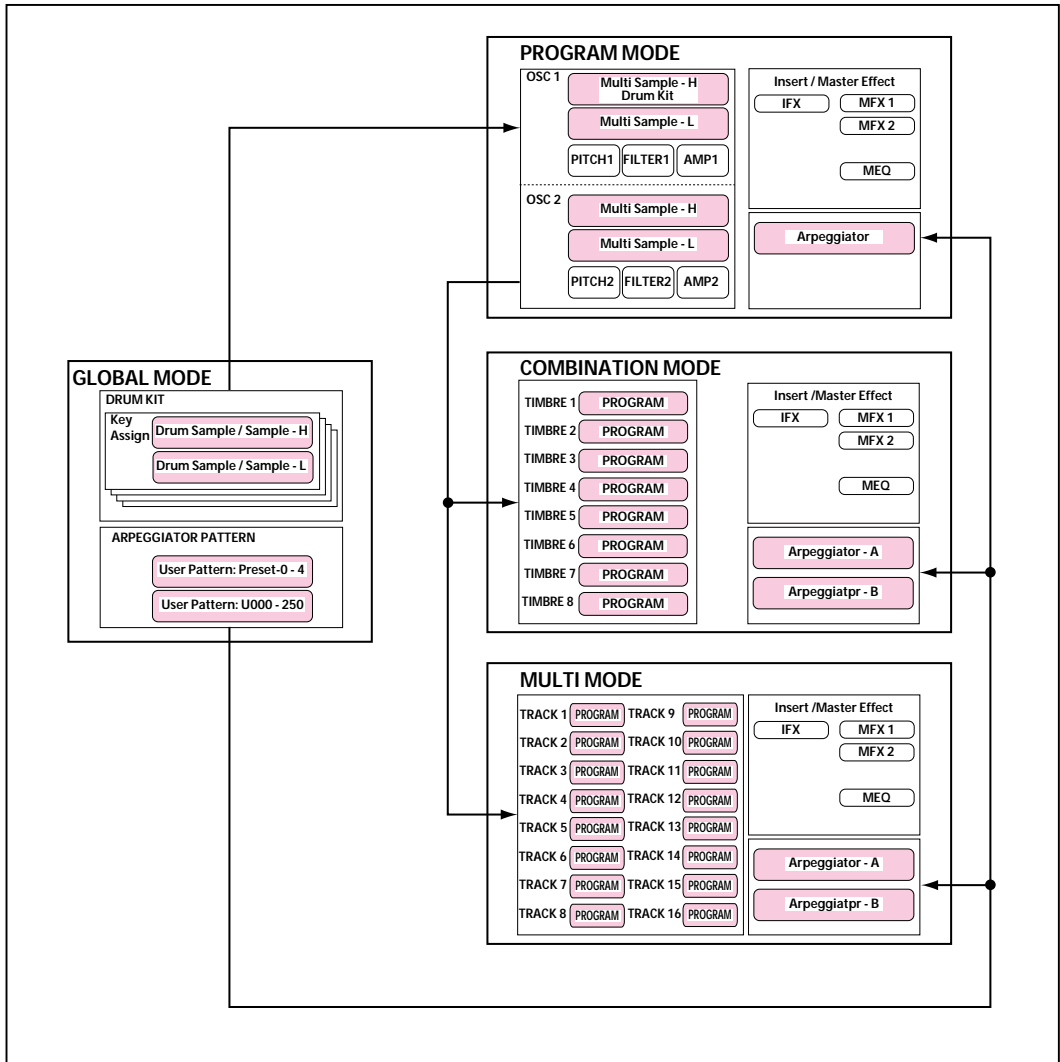



## Basic operations

After you've powered-on the microX, here's how to perform basic operations such as selecting modes and pages.

### 1. Selecting modes

- In order to use a particular function on the microX, you must first select the appropriate mode.

Press one of the front panel mode buttons to enter the corresponding mode.

**PROGRAM [A]–[GM] button:** Program mode

**COMBINATION [A]–[C] button:**

Combination mode

**[MULTI] button:** Multi mode

**[GLOBAL] button:** Global mode

- When you press one of the PROGRAM [A]–[GM] buttons or COMBINATION [A]–[C] buttons, you will enter the selected mode, and the corresponding bank will also be selected as well as a program or combination within that bank.

- For example if you're editing a program in Program mode, and you press a different PROGRAM [A]–[GM] button, the program will change and the settings you had been editing will disappear. The same is true for Combination mode, and the settings you had been editing will disappear if you press a different COMBINATION [A]–[C] button.
- For the [GLOBAL] button or [MULTI] button, pressing that button once again will take you back to the mode and page in which you had previously been.

*Note:* For example, suppose you're editing a program in Program mode, and you press the [GLOBAL] button to enter Global mode. When you've finished editing the Global settings and are ready to resume editing the program, press the [GLOBAL] button once again to return to Program mode. If you return to Program mode by pressing the PROGRAM [A]–[GM] of any bank other than the bank in which you were editing, the settings you had been editing will disappear. For this reason, we recommend that you return to Program mode by pressing the [GLOBAL] button once again, rather than by pressing a PROGRAM [A]–[GM] button. The same is true for the [MULTI] button.

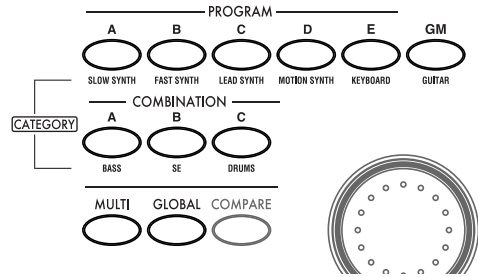

### 2. Selecting pages

Each mode has a large number of parameters, which are grouped into pages. These are further subdivided by tabs into up to eight tab pages.

- Make sure that the desired mode is selected.

For details on selecting a mode, see “1. Selecting modes,” above.

In this explanation we'll use Combination mode as an example.

Press the COMBINATION [A]–[C] buttons.



*Note:* The COMBI 0: Play page will appear. (This is shown in the upper left of the display.)

In Combination, Program, or Multi modes (i.e., in other than Global mode), you will normally perform in this 0: Play page. You can also make simple adjustments (edits) to the sound while you're in this page. To make more detailed adjustments, use page 1 (COMBI 1: Ed-Tone Adjust, etc.) and following.

### Selecting a page

#### Using the page menu to move

In Combination, Program, Global, and Multi modes, you can press the [MENU/OK] button to view a list of the pages that make up that mode.

- Press the [MENU/OK] button.

The page menu will appear.

The page in which you were when you pressed the [MENU/OK] button will be highlighted as an indication.

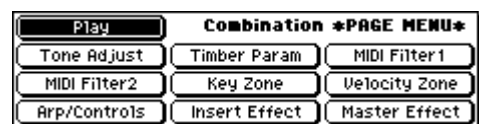

- Use the ClickPoint [**◀**][**▶**][**▲**][**▼**] to select the page you want to view.
- When you've made your selection, press the center of the ClickPoint.

You will jump to the selected page, and that page will appear.

As an example here, try selecting "Key Zone." The 5: Ed-Key Zone page will appear.

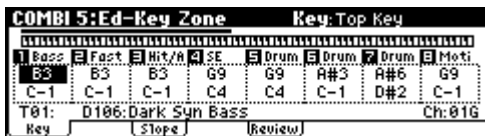

*Note:* The page that appears will be the page of the tab you selected most recently.

*Note:* If you set the Global mode setting "Page Menu Style" to List, you can move by selecting pages and tabs as shown in the following illustration. (The display shown in step 2 is for when "Page Menu Style" = Icon.)



### Using the [MENU/OK] button + [PAGE+][PAGE-] buttons to move

- Hold down the [MENU/OK] button and press the [PAGE+] ([PAGE-] button).

In Combination mode, you will move between pages in the order of 0: Play ↔ 1: Ed-Tone Adjust ↔ 2: Ed-Track Parameter ↔ 3: Ed-MIDI Filter1 ↔ ... etc. The page that appears will be the page of the tab you selected most recently.

### [EXIT/CANCEL] button

- You can press the [EXIT/CANCEL] button to return to page 0 from any page.

### Selecting tabs

#### [PAGE+][PAGE-] buttons

You can press these buttons to move forward or backward in steps of one tab.

- Press the [PAGE+] button to access the page for the next (right) tab. (Press [PAGE-] button to access the page for the previous (left) tab.)

This example shows the Combination page through Prog page of COMBI 0: Play.



- As you repeatedly press the [PAGE+] button or [PAGE-] button, you will move consecutively through the tabs. As you page up past the last tab of a page, you will then move to the first tab of the next page. Likewise, as you page down past the first tab of a page, you will then move to the last tab of the preceding page.

### 3. Selecting a parameter and editing the value

- Use the ClickPoint [**◀**][**▶**][**▲**][**▼**] to select the parameter you want to edit.

The value will be highlighted, and the parameter name is displayed in the upper right of the display. (We call this the "edit cell.")

- To modify the value of the edit cell, use the [VALUE] dial or the ClickPoint.

*Note:* You can use the [COMPARE] button to compare the sound you're editing with the original unedited sound.

### VALUE controllers

#### [VALUE] dial

Use this dial to edit the selected parameter's value.

#### ClickPoint

After selecting a parameter expressed as a numerical value etc., press the center of the ClickPoint; the value will be highlighted, and now you can use [**▲**][**▼**] to increase or decrease the value. To finalize the value, press the center once again.

If you press the [EXIT/CANCEL] button while pressing the ClickPoint center, the selected value will be reset to 0 or the minimum value.

In addition, you can press the ClickPoint center to turn a check box or switch on/off.

#### [COMPARE] button

Use this when you wish to compare the edits you have made to a program or combination's sound with the un-edited original (i.e., the sound that is written into memory).

When editing a program or combination, press this switch. The LED will light, and the last-written settings for that program number or combination number will be recalled. When you press the [COMPARE] button once again, the LED will go

dark and you will return to the settings that you were editing.

If you edit the settings that are recalled by pressing the [COMPARE] button (i.e., the settings that are written into memory), the LED will go dark, and it will not be possible to return to the previous edits by pressing the [COMPARE] button again.

- ⚠ The Compare function is not available in Global mode.

## 4. Selecting and executing a Utility function



The utility functions provide commands that are specific to each page, such Write (save) or Copy. The available utility functions will depend on the page you select.

For example, the utility functions in Program mode let you write (save) the settings, or let you perform convenient editing operations such as copying settings between oscillators or effects, or a Sync function that lets you edit two EGs together.

1. Press the [UTILITY] button.

The utility menu will appear.

2. Use the ClickPoint [▲][▼] to select a command.
3. Press the ClickPoint center.

A dialog box for the selected utility will appear.

(Alternatively, you can access the dialog box by pressing the [UTILITY] button once again or pressing the [MENU/OK] button.)

For check-type commands, the status of the command will simply change without any dialog box appearing.

4. Use the ClickPoint [◀][▶][▲][▼] to select a parameter in the dialog box.
5. To set the parameter value, use the [VALUE] dial, or the ClickPoint (press the center and then use [▲][▼]).
6. To execute the utility command, press the [MENU/OK] button.

If you decide not to execute, press the [EXIT/CANCEL] button. The [EXIT/CANCEL] button is the same as “Cancel,” “Done,” or “Exit.”

The dialog box will close.

- If the utility menu is displayed, press the [EXIT/CANCEL] button to close the menu.

## 5. Writing (saving)

When you're finished editing, you can save your changes if necessary.

For example if you've edited a program, your changed will be lost if you select another program or turn off the power. The same applies to a combination or multi set.

Settings you edit in Global mode will be remembered as long as the power is on, but your changes will be lost when you turn off the power.

For details on the Write operations, see the following pages.

- Programs [p.45](#)
- Combinations [p.61](#)
- Multi sets [p.75](#)
- Global settings (pages 0–3) [p.90](#)
- Drum kits [p.110](#)
- Arpeggio patterns [p.104](#)
- External control [p.112](#)
- Saving data [p.117](#)



# Setup

## Turning the power on/off

### Connecting the AC adapter

- ⚠ You must use only the included AC adapter. Using any other AC adapter may cause malfunctions.

*Note:* Make sure that the microX's power switch is set to STANDBY (the outward position).

1. Connect the plug of the included AC adapter to the power connector on the microX's rear panel.
2. Connect the power cable to the AC adapter.
3. Plug the power cable into an AC outlet.
4. To prevent the plug from being pulled out accidentally, wrap the AC adapter cable through the cable hook located on the rear of the microX. Be careful not to bend the base of the plug unnecessarily.

#### Connecting the AC adapter

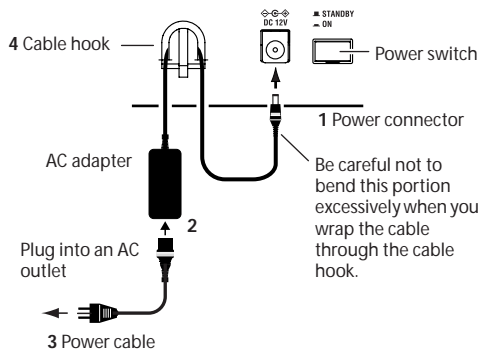

### Turning the power on

1. Turn the microX's [VOLUME] knob toward the left.

If you have connected powered monitor speakers or a stereo amp, turn down the volume of these devices.

2. Press the rear panel Power switch to turn on the power.

The display will show the model name, software version.

(The following graphic shows the factory-set display. The version number is subject to change without notice.)



3. Turn on your powered monitors or stereo amp.
4. Turn the microX's [VOLUME] knob to an appropriate position, and adjust the volume of your powered monitor speakers or stereo amp.

*Note:* The state of microX when the power is turned on will depend on the setting of "Power On Mode" (GLOBAL 0: System, Preference page). (p.88)

---

### Turning the power off

 After you've finished editing, be sure to write (save) your changes.

If you edit a program and then select a different program or turn off the power, the changes you made will be lost. The same is true for a combination or multi set.

The settings you edit in Global mode are remembered as long as the power is on, but will be lost when you turn off the power.

1. Turn the microX's [VOLUME] knob toward the left.

Also turn the volume of your powered monitor speakers or stereo amp down to zero.

2. Turn off the power of your powered monitor or stereo amp.
3. Press the rear panel Power switch to turn off the power.

 Never turn off the power while data is being written into internal memory.

If the power is turned off while processing is being performed, memory write operations will not be completed correctly. If this occurs, microX will automatically initialize its internal memory so that it will operate correctly. This is not a malfunction.

While data is being written, the display will indicate "Now writing into internal memory." Data is written into internal memory by the following operations.

- Writing (updating) a Program, Combination, Multi, Global Setting, Drum Kit, Arpeggio Patterns, or External Control Setup
- Loading a Preload data for Program, Combination, Multi, Global Setting, Drum Kit, Arpeggio Patterns, or External Control Setup
- Receiving a MIDI data dump for Program, Combination, Multi, Global Setting, Drum Kit data, Arpeggio Patterns, or External Control Setup

# Connections

⚡ Connections must be made with the power turned off. Please be aware that careless operation may damage your speaker system or cause malfunctions.

## Basic connections

Connect the audio cables as shown in the connection diagram below.

### Connecting audio output devices

Here, you can connect a set of amplified monitor speakers or your audio system to output microX's sound.

### Connecting the MAIN OUTPUT L/MONO and R

These are the main outputs. They are unbalanced phone jacks.

These are the main stereo outputs; their volume is controlled by the [VOLUME] knob. All of the factory Programs and Combis are programmed to play through these outputs.

If you're editing a program or combination, or playing back from an external MIDI sequencer in Multi mode, you can set "BUS Select" to "L/R" so that the sound will be sent from these jacks.

1. Connect the (MAIN OUTPUT) L/MONO and R jacks to the INPUT jacks of your powered monitor system, mixer etc.

If you are outputting in stereo, make connections to the L/MONO jack and the R jack. If you are outputting in monaural, make connections to the L/MONO jack. We recommend that you playback in stereo if possible.

If you're playing back through a stereo audio amp or a stereo radio-cassette player that has external input jacks, connect these jacks to the jacks marked LINE IN, AUX IN, or External Input. (You may need to use an adapter plug or adapter cable.)

- ⚡ If you playback microX through your stereo audio system, be aware that high volumes may damage your speakers. Be careful not to raise the volume excessively.

### Connecting INDIVIDUAL OUTPUT 1 and 2

If desired, you can connect these two individual (independent) outputs. They are unbalanced phone output jacks.

These jacks allow you to send the microX's sounds to external equipment independent of the (MAIN OUTPUT) L/MONO and R jacks. This can be convenient when recording, or when using a complex live performance setup.

1. Connect the (INDIVIDUAL OUTPUT) 1 and 2 jacks to the input jacks of your mixer etc.

*Note:* The [VOLUME] knob does not affect the volume of jacks 1 and 2.

*Note:* The sound will be sent from these jacks if you set "BUS Select" to 1, 2, or 1/2.

Audio output device connections

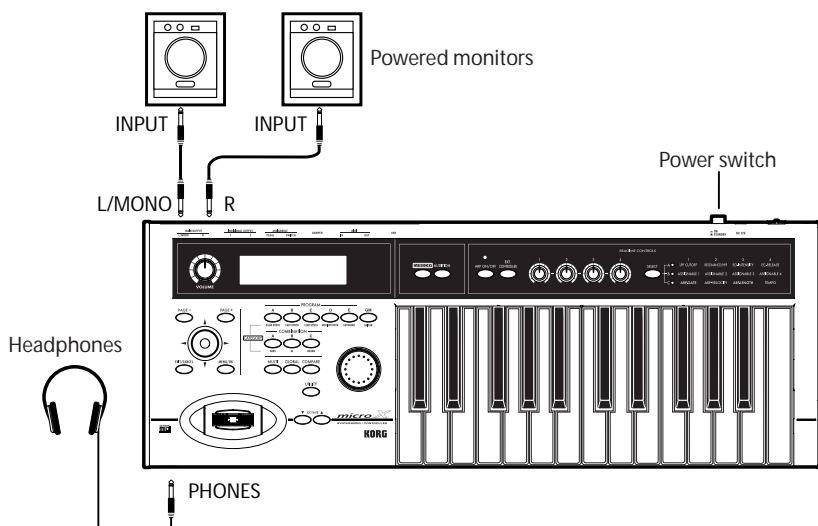

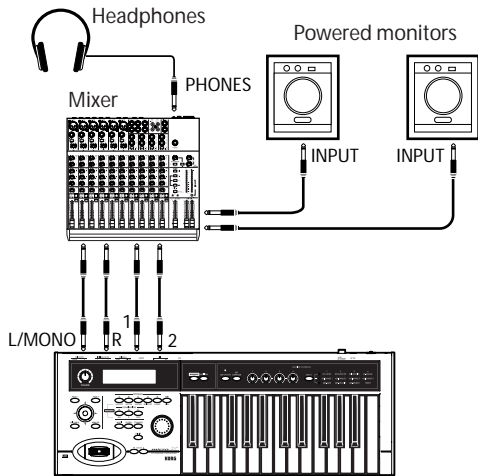

## Headphones

- When using headphones, plug them into the headphones jack located on the front panel. Use the [VOLUME] knob to adjust the volume of the headphones. The microX's headphone jack carries the same signal as the (MAIN OUTPUT) L/MONO and R output jacks.

*Note:* If you want to monitor the (INDIVIDUAL OUTPUT) 1 and 2 jacks in addition to the main outputs, an external mixer may be required.

## Connecting a damper pedal, foot switch, or foot pedal

By connecting an optional damper pedal, foot switch, or foot pedal, you can control even more functions and effects.

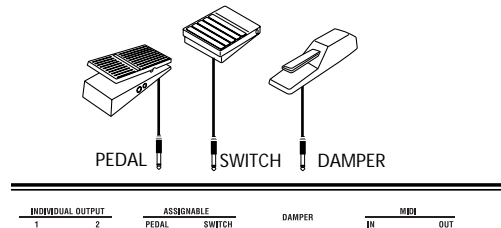

## Connecting a damper pedal

This pedal can provide a damper effect as you play. This instrument also supports half-damping. Here's how to connect an optional Korg DS-1H damper pedal to the DAMPER jack and use it to control the half-damper effect.

- Connect an separately sold DS-1H damper pedal to the DAMPER jack. You'll be able to control the half-damper effect if you've connected the DS-1H. If you've connected a different switch-type pedal, it will function as a damper switch.
- After you turn on the power, set the switch polarity and adjust the half-damper response to ensure that the half-damper pedal works correctly. (PG p.77, 80)

## Connecting a foot switch

If you connect an on/off-type foot switch such as the Korg PS-1 pedal switch to the ASSIGNABLE SWITCH jack, you can use it to turn the sostenuto or soft pedal effect on/off, to turn the arpeggiator on/off, to switch programs or combinations, to control tap tempo, or to apply modulation to a sounds or an effect.

This switch will always function in the same way regardless of the program, combination, or multi set you've selected. You can assign the function in the Global mode 0: System, Foot page.

- Connect a foot switch such as the separately sold PS-1 to the ASSIGNABLE SWITCH jack.
- After turning the power on, use GLOBAL 0: System, Foot page "Foot SW Assign" and "Foot SW Polarity" to assign the function controlled by the foot switch and to specify the polarity. (p.88)



## Connecting a foot pedal

If you connect a separately sold EXP-2 foot controller or XVP-10 expression/volume pedal to the ASSIGNABLE PEDAL jack, you can use it to apply modulation to sounds or effects, or to adjust the overall volume.

This pedal will always function in the same way regardless of the program, combination, or multi set you've selected. You can assign the function in the Global mode 0: System, Foot page.

1. Connect an separately sold XVP-10 or EXP-2 to the ASSIGNABLE PEDAL jacks.
2. After turning the power on, use GLOBAL 0: System, Foot page "Foot Pedal Assign" to assign the function controlled by the foot pedal. (p.89)

## Connecting a computer

You can connect the microX to your computer and use it as both an input keyboard and a MIDI sound module.

You can also use the included editor to edit the microX from your computer.

You can connect the microX to your computer in either of the following ways.

- Use a USB cable
 

*Note:* Use the KORG USB-MIDI Driver if you're connecting the microX via USB to a computer that meets the requirements described in "KORG USB-MIDI Driver operating requirements," below.
- Use a commercially available MIDI interface, and connect the microX via its MIDI connectors.

## Operating requirements for the KORG USB-MIDI Driver and the editor software

### Contents of the CD-ROM

- microX Editor/Plug-In Editor  
(for Windows XP / Mac OS X)
- KORG USB-MIDI Driver  
(for Windows XP / Mac OS X)
- microX External Control Template
- Parameter Guide (PDF)
- Editor/Plug-In Editor Manual (PDF)
- microX External Control Template List (PDF)
- Software License Agreement (PDF)

### Please note before use

- Copyright to all software included in this product is the property of Korg Inc.
- The license agreement for this software is provided separately. You must read this license agreement before you install this software. Your installation of this software will be taken to indicate your acceptance of this agreement.

## KORG USB-MIDI Driver operating requirements

### Windows:

- Computer

A computer with a USB port, that satisfies the requirements of Microsoft Windows XP

- Operating system  
Microsoft Windows XP Home Edition, Professional or x64 Edition (The driver for x64 Edition is a Beta version.)

### Macintosh:

- Computer  
An Apple Macintosh with a USB port that satisfies the requirements of Mac OS X
  - Operating system  
Mac OS X version 10.3 or later
- ⚠ Please be aware that in the case of some computers, the system may not function correctly even if your computer meets the above requirements.

### microX Editor/Plug-In Editor operating requirements

- ⚠ You must install the KORG USB-MIDI Driver if you want to connect the microX to your computer via USB and use the microX Editor/Plug-In Editor.
- ⚠ It is not possible to run multiple instances of microX Editor/Plug-In Editor on the operating system. This means that it is not possible to use these editors to edit two or more microX units simultaneously.

### Windows:

- Computer  
CPU: Pentium III/1 GHz or better  
Memory: 256 MB or more  
Monitor: 1,024 × 768 pixels, 16-bit color or better  
A computer with a USB port, that satisfies the requirements of Microsoft Windows XP
- Operating system  
Microsoft Windows XP Home Edition or Professional, Service Pack 1 or later

### Macintosh:

- Computer  
CPU: Apple G4/400 MHz or better  
Memory: 256 MB or more  
Monitor: 1,024 × 768 pixels, 32,000 colors or better  
An Apple Macintosh with a USB port that satisfies the requirements of Mac OS X
- Operating system  
Mac OS X version 10.3.9 or later

## Windows XP: Installing the KORG USB-MIDI Driver and the editor software

### microX/X50 application installation

The microX application installer automatically installs the KORG USB-MIDI Driver Tools and microX Editor/Plug-In Editor that are provided on the included CD-ROM.

*Note:* You must install the KORG USB-MIDI Driver Tools before you connect the microX to your computer via USB.

1. Insert the included CD-ROM into your CD-ROM drive.

Normally the “microX/X50 Application Installer” will start up automatically.

If your computer is set so the installer does not run automatically, double-click “KorgSetup.exe” on the CD-ROM.

2. From the list, select [KORG microX SYNTHESIZER/CONTROLLER], and click [Next >].



3. From the list, select the applications that you want to install, and click [Install].

If you want to install the preloaded application template files for external control, click “microX External Control templates” to select it.



The applications you selected will be successively installed.

4. Follow the on-screen instructions to install each application.

If you've made settings as shown in the screen shot for step 2, the KORG USB MIDI Driver Tools Installer screen will appear first.

- Click [Next >].
- The "License agreement" will appear. Carefully read the contents, and if you agree, check "I accept the terms of the license agreement" and click [Next>].



- Specify the installation destination. The screen will show the installation destination folder. If you want to change this, click [Change] and select the desired installation destination.
- Click [Next >] to begin the installation.
- When the installation is complete, click [Finish] to exit the installer.

Install the next application in the same way.

5. If you selected microX Editor/Plug-In Editor in step 2, choose the application(s) you want to install.

- Successively select and install the Editor (Standalone), Plug-In Editor (VST), and/or Plug-In Editor (RTAS) as desired.

For example if you want to install the stand-alone version, click [Install Stand-alone version]. Then follow the on-screen directions to perform the installation, and click [Close] when the installation has been successfully completed.

If you want to install a plug-in version, click in the Installer screen to select the format of plug-in that you want to install, and perform the installation.

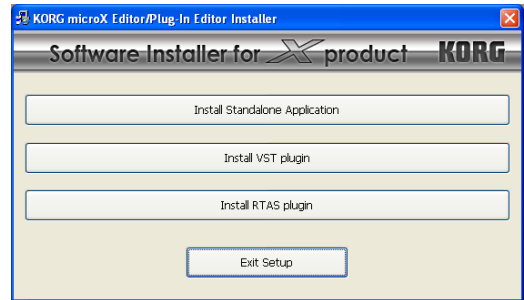

- When you've finished installing the application(s) you want, click [Exit installer] to exit the installer.
6. When all the selected applications have been installed, click [Finish] to exit the installer.



7. The first time you connect the microX to the USB port of your computer, the standard USB-MIDI driver provided by Windows will be installed automatically.

If you want to use the KORG USB-MIDI Driver for Windows XP, please re-install the driver manually using the procedure described below.

## Setting up the KORG USB-MIDI Driver

1. Before you perform the procedure below, you must finish installing KORG USB-MIDI Driver Tools into your computer.

Then restart the operating system of your computer, and power-on the microX. (p.23)

**Note:** The driver must be installed for each USB port. If you connect the microX to a different USB port than the one you used when installing KORG USB-MIDI Driver for Windows, you will need to use the same procedure to install the driver again.

2. Using a USB cable, connect the USB connector of the microX to the USB connector of your computer.

Make sure that the plug is oriented correctly, and push it all the way into the connector.

Windows will detect that the microX has been connected.

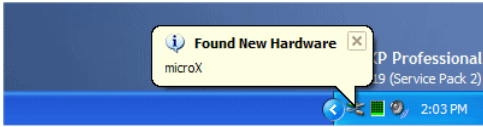

Then the standard driver will be installed automatically.

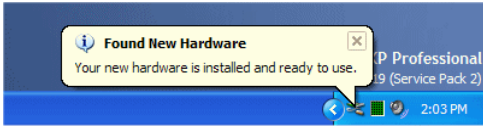

- In the task bar, choose [Start] → [All Programs] → [KORG] → [KORG USB-MIDI Driver Tools] → [Install KORG USB-MIDI Device] to start up the setup utility.

The KORG USB-MIDI devices currently connected to your computer will be shown in the list above. The lower area will show the version of the KORG USB-MIDI Driver that you will be installing. Select microX in the list above, and click [Install]. Driver installation will begin.



- If a warning dialog box regarding digital signature authentication appears during the installation, click [Continue] to continue the installation.



- Driver installation has been completed. Click [Finish] to exit the installer. If you are asked whether you want to restart Windows now, choose [Yes] to restart.

*Note:* For details on installation and setup, and on uninstallation, see the “Installation manual” (HTML) on your computer. To view the “Installation manual,” click from your taskbar’s [Start] → [All Programs] → [KORG] → [KORG USB-MIDI Driver Tools] → [Installation manual].

## About the microX and driver ports

### KEYBOARD port

Applications on your computer use this port to receive MIDI messages from the microX (data from the keyboard and controllers).

### SOUND port

Applications on your computer use this port to send MIDI messages to the microX’s internal sound generator, making it produce sound.

## Setting up the microX Editor/Plug-In Editor

For details on setting up and using the microX Editor/Plug-In Editor, see “Editor/Plug-In Editor Manual” (PDF).

## About the microX external control templates

See “microX External Control Template List” (PDF) for details on the control change (CC#) settings assigned by the preloaded external control templates and the application settings to which they correspond.

## Mac OS X: Installing the KORG USB-MIDI driver and editor software

### Installing the KORG USB-MIDI Driver

*Note:* Use the KORG USB-MIDI Driver if you are connecting the microX via USB to a computer that satisfies the conditions listed in “KORG USB-MIDI Driver operating requirements” (p.27).

1. Insert the included CD-ROM into your CD-ROM drive.
2. In the CD-ROM, navigate to the “KORG USB-MIDI Driver” folder, and double-click “KORG USB-MIDI Driver.pkg” to start up the installer.
3. Depending on the version of your operating system, a confirmation dialog box may appear at this point. If so, enter your password and click [OK]. When the installer starts up, the following screen will appear. Click [Continue].



4. “Import information” will appear. Read the contents, and click [Continue].
5. The “License agreement” will appear. Carefully read the contents, and click [Continue].  
A dialog box will ask whether you accept the terms of the license agreement. If you accept, click [Agree].
6. A screen where you can choose the “Installation destination” will appear. Choose the installation destination and click [Continue].



7. The “Easy Installation” dialog box will appear. Click [Install].
8. Depending on the version of your operating system, a confirmation dialog box may appear at this point. If so, enter your password and click [OK].
9. When the installation has been successfully completed, click [Close] to exit the installer.

### About the microX and driver ports

#### KEYBOARD port

Applications on your computer use this port to receive MIDI messages from the microX (data from the keyboard and controllers).

#### SOUND port

Applications on your computer use this port to send MIDI messages to the microX’s internal sound generator, making it produce sound.

### Installing the microX Editor/Plug-In Editor

To install the software in Mac OS X, proceed as follows.

1. Insert the included CD-ROM into your CD-ROM drive.
2. In the CD-ROM, navigate to the “microX Editor” folder, and double-click “microX Editor Installer.pkg” to start up the installer.
3. Follow the on-screen instructions to install application.  
See “Installing the KORG USB-MIDI Driver.”
4. When the installation has been successfully completed, click [Restart].

*Note:* If you’re using Mac OS X, the plug-in version will also be installed in the appropriate folder.

### Setting up the microX Editor/Plug-In Editor

For details on setting up and using the microX Editor/Plug-In Editor, see “Editor/Plug-In Editor Manual” (PDF).

### Installing the microX External Control Temperate

To install the software in Mac OS X, proceed as follows.

1. Insert the included CD-ROM into your CD-ROM drive.
2. In the “microX External Control” folder on the CD-ROM, double-click “microX External Control.pkg” to start up the installer.

3. Follow the on-screen instructions to install application.  
See “Installing the KORG USB-MIDI Driver” (p.31).
4. When the installation has been successfully completed, click [Close] to exit the installer.

### About the microX external control templates

See “microX External Control Template List” (PDF) for details on the control change (CC#) settings assigned by the preloaded external control templates and the application settings to which they correspond.

---

## Connecting via the microX’s USB connector, and setting-up

### USB connector (for connecting to computer)

If you connect the microX’s USB connector to your computer, you’ll be able to send and receive note data and other performance information and sound settings between your computer and the microX as MIDI messages.

*Note:* The USB connector of the microX is only able to transmit and receive MIDI data.

*Note:* Use the KORG USB-MIDI Driver if you’re connecting the microX via USB to a computer that meets the requirements described in “KORG USB-MIDI Driver operating requirements.”

1. Using a USB cable, connect the USB connector of the microX to the USB connector of your computer.

Make sure that the plug is oriented correctly, and push it all the way into the connector.

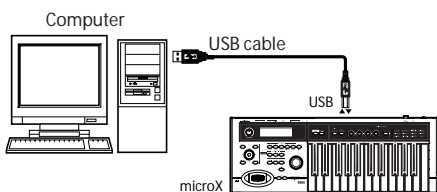

2. Make the necessary settings in the microX’s Global mode.

See “Global mode settings on the microX,” below.

---

## Connecting to your computer via MIDI

Here’s how to connect the microX to your computer via a commercially available MIDI interface.

1. Connect the microX’s MIDI OUT connector and MIDI IN connector to your computer via the MIDI interface.

For details on how to use your MIDI interface, see its owner’s manual.

- ⚠ Some models of USB-MIDI interface may be unable to transmit or receive the microX’s MIDI exclusive messages.

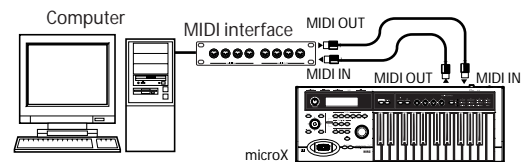

2. Make the necessary settings in the microX’s Global mode.

See “Global mode settings on the microX,” below.

---

## Global mode settings on the microX

### Local Control On settings

Turn on the Echo Back function of the external MIDI/USB sequencer or computer (so that data received at MIDI IN will be re-transmitted from MIDI OUT/USB), and turn **off** the microX’s **Local Control** setting (so that microX’s keyboard and tone generator will be internally disconnected).

When you play the keyboard of the microX, the musical data will be transmitted to the external MIDI sequencer or computer, and then echoed back to play the microX tone generator. In other words, by turning Local Control OFF, you can prevent notes from being sounded in duplicate, as would otherwise occur if a note were sounded by the microX’s own keyboard and again by the data that was echoed-back.

If the arpeggiator function is on, playing the microX’s keyboard will not cause the arpeggiator to operate, and only the musical data produced by playing the keyboard will be transmitted. The arpeggiator will operate only in response to the notes that are echoed-back and received at MIDI IN. In this way, turning off Local Control prevents the arpeggiator from operating in duplicate. Use this setting when you wish to record on the external MIDI sequencer or computer only the notes that trigger the arpeggiator, and to use the

echoed-back notes to operate the arpeggiator while monitoring your recording or during playback.

*Note:* If you want the note data produced by the arpeggiator to be recorded on the external sequencer/computer, set Local Control on, and turn off the Echo Back setting of the external sequencer/computer.

The default setting for Local Control is On. To turn off Local Control, the “Local Control On” (GLOBAL 1: MIDI page) check box to **uncheck** it (PG p.82).

When using the microX by itself, leave Local Control turned on. (If this is **off** when microX is used by itself, playing the keyboard will not produce sound.)

*Note:* The microX’s Local Control setting can be turned Off by the Local Control Off message sent from the editor when you start up microX Plug-In Editor.

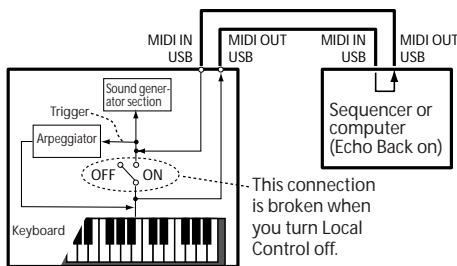

### MIDI Filter “Exclusive” setting

If you want the microX to transmit and receive system exclusive data, you must check the GLOBAL 1: MIDI page MIDI Filter “Exclusive” check box. Check this box if the microX is connected to your computer and you want to edit the microX from your computer (or bi-directionally). You must also check this box if you’re using the microX Editor/Plug-In Editor. By default, the MIDI Filter “Exclusive” setting is checked.

### The “Convert Position” setting

On the microX, the parameters “Key Transpose” and “Velocity Curve” (GLOBAL 0: System, Basic page) allow you to transpose the pitch, adjust the velocity sensitivity.

The “Convert Position” setting (GLOBAL 1: MIDI page) specifies the point at which these settings affect the data from the keyboard and the data sent or received via MIDI IN/USB or MIDI OUT/USB.

- When controlling an external MIDI tone generator from the microX, select **Pre MIDI**. The

above-listed settings will affect the MIDI data that is transmitted.

Incoming MIDI data will be handled with settings equivalent to “Key Transpose” **0** and “Velocity Curve” **4**.

- When controlling the microX’s tone generator from an external MIDI device, select **PostMIDI**. The above-listed settings will affect the MIDI data that is received.

Outgoing MIDI data will be handled with settings equivalent to “Key Transpose” **0** and “Velocity Curve” **4**.

The default settings are “Key Transpose” +00, “Velocity Curve” 4 (Normal), and “Convert Position” PreMIDI.

### “Multi Mode” setting

You will normally use Multi mode when you’re using the microX as a multi-timbral sound module to simultaneously play multiple tracks from an external MIDI sequencer. However, you can also use Multi mode when you want to use the microX as a master keyboard to control an external MIDI sound module. (Normally you will use Combination mode if you’re using the microX as a master keyboard.)

Depending on which of these two situations describes your needs, you can set the “Multi Mode” setting in the GLOBAL 0: System, Preference page so that the microX will operate optimally for your situation.

**for Ext-Seq** is the setting you should choose when using the microX as a multi-timbral sound module. When you switch multi sets on the microX, tracks whose “Status” is EXT or BTH will not transmit MIDI messages such as program changes. This will avoid the undesired situation of the echo back from your external MIDI sequencer switching microX tracks of the identical channel to the same program, pan, and volume settings etc.

**for Master** is the setting you should choose when using the microX as a master keyboard. In this case when you switch multi sets on the microX, tracks whose “Status” is EXT or BTH will transmit program changes and other MIDI messages to set up your external MIDI sound module.

### Making settings in Global mode

Here’s how to set parameters in Global mode.

1. Press the [GLOBAL] button (the button will light) to enter Global mode.
2. Press the [MENU/OK] button to access the page menu.

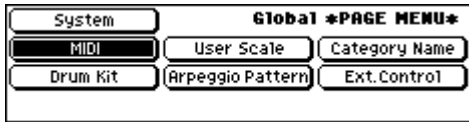

- Use the ClickPoint [◀][▶][▲][▼] to select a page, and press the ClickPoint center.
  - Local Control On
  - MIDI Filter Exclusive
  - Convert Position

Choose “MIDI” if you want to make these settings.

The GLOBAL 1: MIDI page will appear.

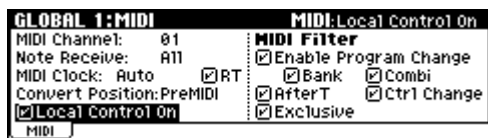

- Multi Mode
- Choose “System” if you want to make these settings.

One of the GLOBAL 0: System pages will appear. Use the [PAGE+]/[PAGE-] buttons to select the Preference page.

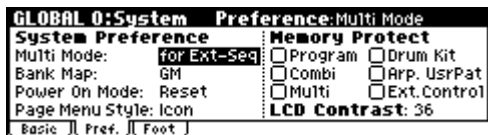

- Use the ClickPoint [◀][▶][▲][▼] to select the parameter whose setting you want to change.
 

For “Local Control On” or “Exclusive,” select the parameter and press the ClickPoint center to switch the parameter on/off.

For the “Local Control On” parameter, local control will be off when the box is unchecked.

For “Convert Position” and “Multi Mode,” select the parameter and turn the [VALUE] dial to change the setting.

## Example connections when using the microX Editor/Plug-In Editor

If you want to mix the microX’s audio signals with the audio signals sent from your host application via your audio interface, or with audio signals from another sound module, make connections as shown below.

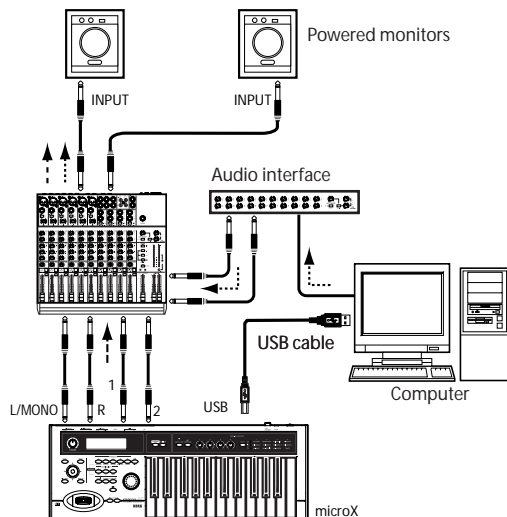

If you want to apply a plug-in effect to the microX’s audio signals, or to control the microX’s audio signals in your host application together with the audio data from the KORG Legacy Collection or other audio tracks, make connections as shown below. Make settings as appropriate for the host application you’re using.

For details on setup, see “Editor/Plug-In Editor Manual” (PDF).

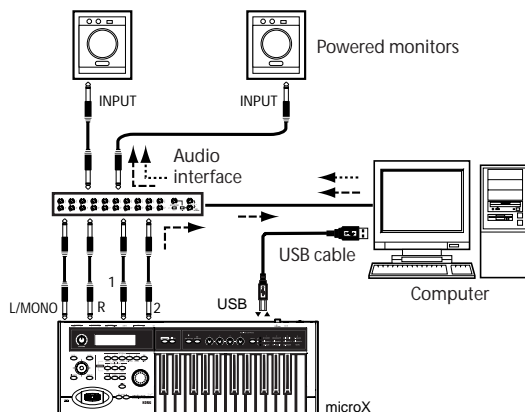



## Connecting MIDI devices

By connecting the microX's MIDI connectors to an external MIDI device you can transfer sound settings and performance data such as note messages between your external MIDI device and the microX.

### About MIDI

MIDI stands for Musical Instrument Digital Interface, and is a world-wide standard for exchanging various types of musical data between electronic musical instruments and computers. When MIDI cables are used to connect two or more MIDI devices, performance data can be exchanged between the devices, even if they were made by different manufacturers.

### MIDI connectors

#### MIDI IN:

This connector receives MIDI data.

Use this to play the microX from another MIDI device, or from an external sequencer.

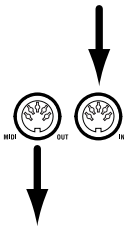

#### MIDI OUT:

This connector transmits MIDI data.

Use this to control external MIDI devices, or to record into an external sequencer.

### Controlling an external MIDI tone generator from microX

When you wish to use the microX's keyboard, controllers, and arpeggiator etc. to play an external MIDI tone generator, use a MIDI cable to connect microX's MIDI OUT connector to the MIDI IN connector of the external MIDI tone generator.

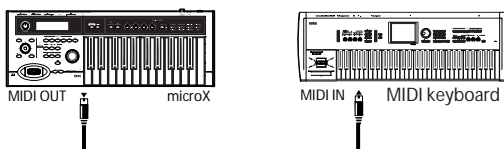

### Controlling microX's tone generator from an external MIDI device

When you wish to play or control the microX's tone generator from an external MIDI keyboard or sequencer etc., use a MIDI cable to connect the MIDI OUT connector of the external MIDI device to the MIDI IN connector of microX.

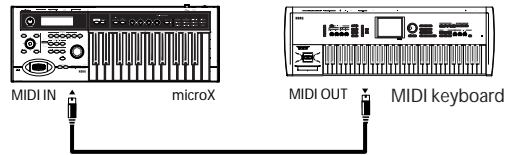

### Controlling two or more external MIDI tone generators from microX

You can also use a MIDI patch bay to control multiple MIDI devices.

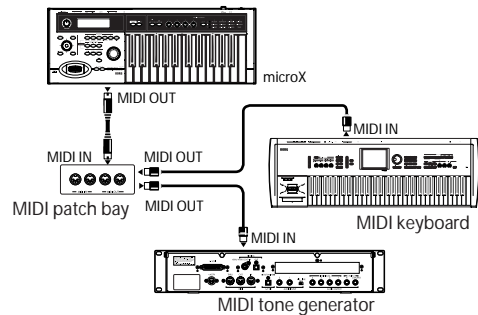

### Connecting an external MIDI sequencer

You can connect the microX to your external MIDI sequencer and use it both as an input keyboard and as a MIDI sound module.

1. Connect the microX's MIDI OUT connector to your MIDI sequencer's MIDI IN connector, and connect the sequencer's MIDI OUT connector to the microX's MIDI IN connector.
2. Make the necessary settings in the microX's Global mode.

See "Global mode settings on the microX" (p.32).

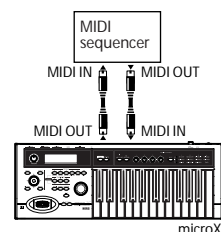



# Playing and Editing Programs

## What's a Program?

Programs are the basic sounds of the microX.

Programs are important elements of other modes as well. In Combination mode you can combine multiple programs to create complex sounds, and in Multi mode you can play multiple programs by

receiving MIDI messages from multiple tracks of your MIDI sequencer or other DAW program.

This section of the manual takes a quick look at playing Programs, including tours of the front-panel controllers and basic editing techniques.

## Playing programs

### Selecting programs

There are several different ways to select programs. Each one is convenient in a different way:

#### • Selecting programs from the front panel:

##### Using “Program Select” to select a program

- Turn the [VALUE] dial.
- Press the center of the ClickPoint to highlight the field, then use [▲][▼] to select a program, and press the center to finalize your selection.
- Use the PROGRAM [A]–[GM] buttons to select a program bank.

##### Selecting programs by program category

You can select programs by categories such as piano or drums. (see p.38)

#### • Selecting programs by using a foot-switch:

You can change programs even while both hands are busy playing on the keyboard - convenient for live applications.

#### • Selecting programs by receiving MIDI program changes:

You can switch programs from an external MIDI sequencer or an external MIDI controller.

See below for details.

### Selecting programs from the front panel

1. Press a PROGRAM [A]–[GM] button. (The button will light.)

You will enter Program mode, and the bank you specified will be selected. Notice that the upper line of the display indicates “PROG 0: Play” (mode name, page number and name).

The bank number you specified is shown below “PROG 0: Play.”

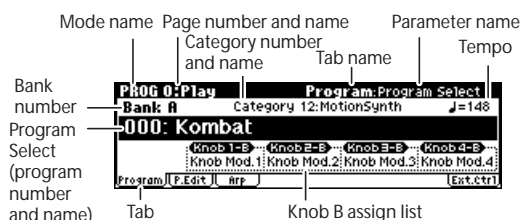

2. Make sure that “Program Select” (program number and name) is selected.

If this is not selected, use the ClickPoint [▲][▼] to highlight the “Program Select” indication.

3. Use the [VALUE] dial etc. to select the program you want to play.

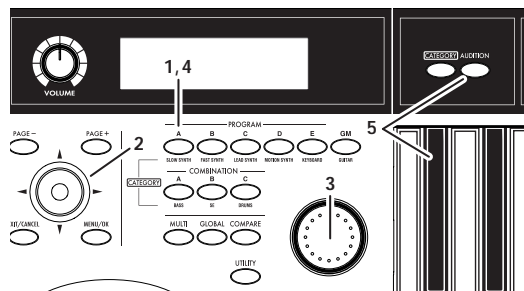

You can use the following methods to select a program.

- Turn the [VALUE] dial.
- Press the center of the ClickPoint to highlight the field, then use [▲][▼] to select a program, and press the center to finalize your selection.
- 4. Press a PROGRAM [A]–[GM] button to switch banks.

When you select a different Bank, the button's LED will light, and the selected bank will appear on the left side of the display.

For example, to select bank B, press the PROGRAM [B] button. The [B] button will light, and the name Bank B will appear in the left of the display.

- Each time you press the [GM] button, the bank will alternate as shown below.

G→g(d)→G→g(d)→G...

## Auditioning the sound

- Play a note on the keyboard to hear the sound you selected.

Alternatively, you can press the [AUDITION] button (the button will light) to turn on the Audition function and the microX will automatically play a riff (phrase) suitable for the selected program.

## Overview: Program Banks

When shipped from the factory, it is loaded with 640 Programs. You can also save any programs that you create.

Programs are organized into six banks as shown in the following table.

### Program banks

Bank	Prog. No.	Explanation
A, B, C, D, E	000...127	for preloaded programs With the factory settings, these banks contain a wide variety of preloaded programs that use the internal PCM ROM multisamples, effects, and arpeggio patterns. 128 programs can be written or rewritten to each bank (for a total of 640).
G	001...128	GM programs These banks contain 128 GM programs and nine GM drum programs that are compatible with the GM sound map. The programs of these banks are read-only.
g(d)	001...128	GM2 drum programs Bank G contains the GM programs. G lets you select 128 programs numbered from 001-128, and g(d) lets you select nine drum programs. You can't write (save) data to these banks.

## Selecting by Category

You can select Programs from within a category, such as keyboard, organ, bass, and drums.

When shipped from the factory, the preloaded Programs are organized into 16 categories.

In the PROG 0: Play page you can select programs by category as follows.

## Using [CATEGORY] and the PROGRAM/COMBINATION buttons to select

- Press the [CATEGORY] button.

The category menu will appear. The categories are displayed in the left side of the screen, and a list of the programs in the selected category are displayed in the right side.

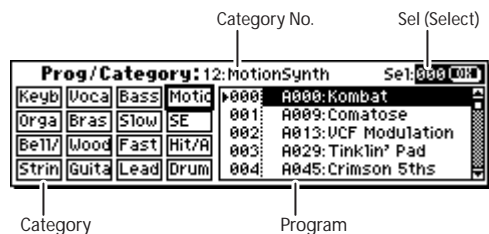

- Press the PROGRAM [A]-[GM] or COMBINATION [A]-[C] button for the desired category.

The category you specify will be selected. A category name is printed below each bank button.

*Note:* This method lets you select up to nine categories.

- You can use the [PAGE+][PAGE-] buttons to step through the categories one by one.
- By using the [VALUE] dial or the ClickPoint [▲][▼] to select programs, you can step through the programs in the same category.
  - Press the [MENU/OK] button to confirm your selection. If you decide not to select a program, press the [EXIT/CANCEL] button.

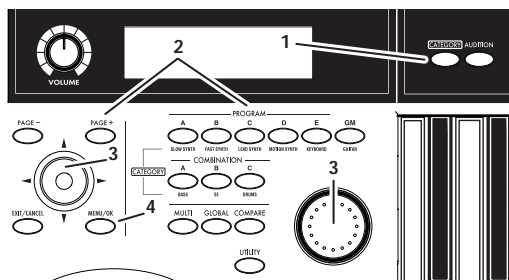

*Note:* You can also switch categories by using the ClickPoint [◀][▶] to select "Category No." in the top line of the category menu and then turning the [VALUE] dial.

## Using a footswitch to select Programs

You can assign a footswitch to step through Programs one by one, either going up (0, 1, 2, 3, etc.) or going down (3, 2, 1 etc.).

This lets you change Programs without using your hands—great for quick Program changes in live performance situations.

To set this up:

1. Connect a foot switch to the rear-panel ASSIGNABLE SWITCH jack.  
Use a simple on/off footswitch, such as the optional KORG PS-1.
2. Press the [GLOBAL] button to enter Global mode.
3. Press the [EXIT] button to access the GLOBAL 0: System page.
4. Press the [PAGE+] button to access the Foot tab.

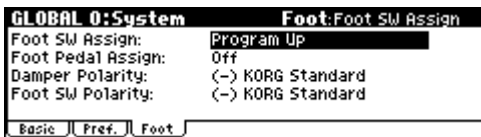

5. Select “Foot SW Assign,” and specify either Program Up or Program Down.  
**Program Up** lets you select the next higher program number each time you press the foot switch.  
**Program Down** lets you select the next lower program number each time you press the foot switch.
6. Set the “Foot SW Polarity” to the polarity of the pedal you’ve connected.

If you’ve connected a separately sold PS-1 pedal switch, choose the (-) KORG Standard setting.

With these settings, you will step through the programs one at a time each time you press the foot switch.

If you want this setting to be remembered even after you turn off the power, be sure to write the changes you made. (p.45)

7. Use the PROGRAM [A]–[GM] buttons to enter PROG 0: Play, and press the foot switch; the program will change.

*Note:* This setting applies to selecting Combinations, as well.

## Using MIDI program change messages to select programs

By sending MIDI program change messages along with MIDI bank select messages to the microX from an external MIDI device (a MIDI sequencer such as a DAW program, or a MIDI controller, etc.), you can select any program in the seven banks.

You can also install the included “microX Plug-In Editor” into your DAW program as a plug-in, and easily select microX programs or combinations from a list within your DAW. For more details, see “Editor/Plug-In Editor Manual” (PDF).

## MIDI channel setting

In order to play the microX via MIDI, the transmitting device (MIDI sequencer or computer) and receiving device (the microX) must be set to the matching MIDI channel. In Program mode, the microX receives data on the global MIDI channel.

1. Make sure that the microX and your external MIDI device or computer are connected correctly.

For details on connections, see p.27.

2. Press the [GLOBAL] button to enter Global mode.
3. Press the [MENU] button to access the PAGE MENU.
4. Use the ClickPoint [◀][▶][▲][▼] to select “MIDI,” and press the center.

The GLOBAL 1: MIDI page will appear.

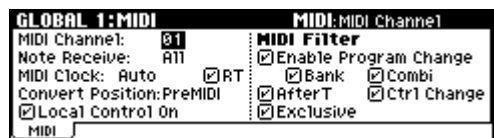

5. Use the ClickPoint [◀][▶][▲][▼] to select “MIDI Channel,” and use the [VALUE] dial to specify the global MIDI channel.

With the default settings, the global MIDI channel “MIDI Channel” is set to 01.

## Selecting programs

To switch programs, send a MIDI program change from your external MIDI device or computer.

To switch banks, send a Bank Select control change message (CC#0: upper byte, CC#32: lower byte). The microX will switch to the program of the specified bank at the time that it receives a program change following the bank select message.

microX Bank #	microX Program #	Bank Select CC#0	Bank Select CC#32	Program #
A	0 – 127	63	0	0 – 127
B	0 – 127	63	1	0 – 127
C	0 – 127	63	2	0 – 127
D	0 – 127	63	3	0 – 127
E	0 – 127	63	4	0 – 127
G	1 – 128	121	0, 1 – 9	0 – 127
	1 – 128: R	56	0	0 – 127
	1 – 128: (XG) R	0	0, 1	0 – 127
	1 – 128: (GS) R	0	0	0 – 127
1		0	0 – 127	
g(d)	1 – 128	120	0	0 – 127
	1 – 128: R	62	0	0 – 127

*Note:* In bank G, program numbers 000 through 127 correspond to 001–128.

*Note:* “R” (Receive) indicates that only reception is supported.

*Note:* Bank select messages will not be transmitted or received if the GLOBAL 1: MIDI page MIDI Filter “Bank” is unchecked.

*Note:* The table above describes the operation with “Bank Map” set to GM. For details on the KORG mapping (see PG p.78).

## Using Controllers

The microX provides realtime controllers such as a joystick and OCTAVE [▼][▲] buttons that let you make your performances more expressive.

These controls let you modify the tone, pitch, volume, effects, etc. in realtime while you play.

For example, a piano sound can be played realistically using only the keyboard, but your performance will be more expressive if you connect a damper pedal. If you’re playing guitar or wind instrument sounds, you can use the joystick to control the pitch or to apply vibrato.

*Note:* In the pages that follow, our explanation will center on the dedicated functionality of each controller. However, you can also use these controllers as sources for “alternate modulation” or “effect dynamic modulation,” giving you a much wider range of possible uses than we describe here. For details on these capabilities, see “Using Alternate Modulation” (see p.51) and PG p.151.

## Keyboard

### Velocity

How hard you play the keyboard affects the expressiveness of the sound. You can adjust the volume level setting so that playing the keyboard softly will produce a soft sound, and playing hard will produce a loud sound. In addition, you can also adjust the brightness of the sound and the envelope settings such as attack rate and release time.

Using Velocity Switch in Combination Play mode and Multi mode, you can play different Programs by changing the keyboard velocity.

- See PROG 6: Ed–Amp1/2, Mod (see p.55, PG p.21) for information on how to change the volume level and envelope using key velocity.
- See PROG 4: Ed–Filter1/2, Basic, Mod.1 (see p.54, PG p.16) for information on how to change the brightness and tonal color of the sound using key velocity.
- See PROG 2: Ed–Pitch, OSC1/2 (see PG p.10) for information on how to control the pitch change using key velocity.

### Note Number

Sounds can be programmed to change in character based on the note being played. As you play higher or lower on the keyboard, the note number can modulate the timbre—such as becoming brighter as you play higher. Envelopes may also become faster or slower; the volume may change; and so on.

## Joystick

You can use the joystick to vary the pitch or adjust the depth of modulation. The actual result will depend on the program, but these controllers are normally used to apply the following effects.

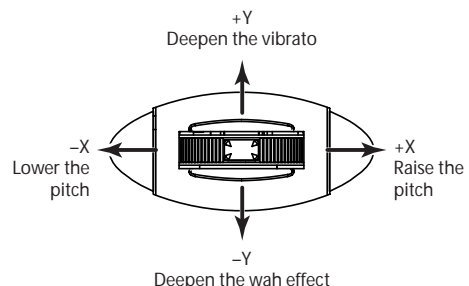

- Joystick movement in the +X/-X axis can adjust the amount of pitch bend  
PROG 2: Ed–Pitch, OSC1 (see p.52, PG p.10)

- Joystick movement in the +X/-X axis can vary the cutoff frequency  
PROG 4: Ed-Filter1/2, Mod.2 (☞PG p.16)
- Joystick movement in the +Y axis can adjust the depth of vibrato  
PROG 2: Ed-Pitch, OSC 1/2 LFO (☞p.52, PG p.11)
- Joystick movement in the -Y axis can adjust the depth of the wah effect  
PROG 4: Ed-Filter1/2, LFO Mod. (☞p.54, PG p.18)
- Joystick movement in the +Y axis can adjust the speed of the LFO  
PROG 3: Ed-LFOs, OSC 1/2 LFO 1/2 (☞PG p.14)

## OCTAVE

These buttons shift the range of pitches assigned to the keyboard in one-octave steps over a range of  $\pm 3$  octaves.

Pressing the [▲] button will raise the pitch in one-octave steps. Pressing the [▼] button will lower the pitch in one-octave steps.

You can press the OCTAVE [▼][▲] buttons simultaneously to recall the written (saved) settings.

### OCTAVE [▼][▲] functions

Press the [▼] button	Keyboard range	LED status	Press the [▲] button
▼	C6 – C8	Rapid blinking	▲
▼	C5 – C7	Slow blinking	▲
▼	C4 – C6	Lit	▲
▼	C3 – C5	Dark	▲
▼	C2 – C4	Lit	▲
▼	C1 – C3	Slow blinking	▲
▼	C0 – C2	Rapid blinking	▲

Press the [▼][▲] buttons simultaneously	Keyboard range	LED status
▼ + ▲	Written value	Corresponds to pitch range

*Note:* With the factory settings, changing the program, combination, or multi set will also recall the OCTAVE [▼][▲] button setting that was written as part of that data. This is because the GLOBAL 0 “OCTAVE Keys [▼/▲]: Use Prog/Combi/Multi’s Octave” setting is checked. If this setting is not checked, changing the program etc. will not affect the OCTAVE [▼][▲] setting until you change the octave yourself. (☞p.88)

## REALTIME CONTROLS [1], [2], [3], [4], [SELECT]

Use the [SELECT] button to select realtime controller mode A/B/C, and use knobs [1]–[4] to control the tone, effects, MIDI control changes, and arpeggiator etc. while you perform.

Specifically, you can use these controllers to edit the filter cutoff frequency, resonance, amp and filter EQ, volume, portamento time, pan, pitch LFO, and master effect send level, etc. You can also use them to modify the arpeggiator tempo, gate, velocity, and length. For more details, see p.43 and p.91.

1. Press the REALTIME CONTROLS [SELECT] button to switch the function of the realtime controllers to A-mode, B-mode, or C-mode.
2. Rotate the desired knob to control the sound, etc.

The REALTIME CONTROLS [1], [2], [3], and [4] knob B-mode functions can be viewed for Program mode in the 0: Play, Program page; for Combination mode in the 0: Play, Combination page; and for Multi mode in the 0: Play, Multi page. (☞p.37)

*Note:* If you turn the [EXT. CONTROLLER] button on (lit), these knobs will be switched to the external control function, and will be disconnected from the internal sound generator. The REALTIME CONTROLS [1]–[4] knobs will transmit MIDI messages (as specified by the external control setup) to your external MIDI equipment.

## Using the pedals for control

### Damper Pedal (Sustain)

The damper pedal is also sometimes called the sustain pedal. It acts like the similarly-named pedal on an acoustic piano; when you hold down the pedal, notes will continue to sustain even when you lift your hands off of the keyboard.

### Damper Switch vs. Half-Damper

You can use either a standard footswitch (such as the Korg PS-1) or a special half-damper pedal (such as the Korg DS-1H) as the Damper. If you use a footswitch, it will work like a normal synthesizer sustain pedal: notes will sustain forever, as long as the pedal is held down.

A half-damper pedal is a special type of continuous foot pedal (normal foot pedals won’t work properly for this application). It offers more subtle control of sustain, which can be especially useful for piano sounds.

The microX will automatically sense when a half-damper is connected to the rear-panel DAMPER jack. For proper operation, you will also need to calibrate the pedal, using the “Half Damper Calibrate” command in the Global page menu. (PG p.77)

### Assignable Foot Switch

This lets you use a simple footswitch, such as the Korg PS-1, as an assignable controller. The footswitch can perform a wide variety of functions, such as:

- Sound and effect modulation
- Portamento on/off
- Program select up or down
- Tap Tempo
- Arpeggiator on/off
- Duplication of many front panel controls, including the modulation Joystick, Real-Time Knobs

Functions other than the above “Sound and effect modulation” will always operate as specified by the GLOBAL 0: System, Foot page, regardless of the currently selected program, combination, or multi set.

For more information, see “Specifying the function of the ASSIGNABLE Switch and ASSIGNABLE Pedal” (p.88).

### Assignable Foot Pedal

This lets you use a continuous controller pedal, such as the Korg EXP-2 foot controller or Korg XVP-10 EXP/VOL pedal, as an assignable controller.

Like the Assignable Foot Switch, described above, the Foot Pedal can be used for many different functions, including:

- Master Volume
- Channel Volume, Pan, or Expression
- Assignable sound modulation, as several different AMS or Dmod sources
- Effects Send level control
- Duplication of many front panel controls, including the modulation Joystick, Real-Time Knobs

Functions above will always operate as specified by the GLOBAL 0: System, Foot page, regardless of the currently selected program, combination, or multi set.

For more information, see “Specifying the function of the ASSIGNABLE Switch and ASSIGNABLE Pedal” (p.88).

---

### External control

You can use the REALTIME CONTROLS [1], [2], [3], and [4] knobs to transmit MIDI messages. This can be used to control a KORG Legacy Collection software synthesizer or DAW program running on your computer, or to control an external MIDI device.

You can assign three control changes to each knob and switch between them using the [SELECT] button, giving you a total of twelve different control changes. These twelve assignments (four knobs x three sets) are one “set,” and the microX provides 64 such sets. (p.111)

### [EXT. CONTROLLER] button

This switches the external function on/off. If this is on, the button will light and the realtime control functions will be disabled.

When this is on, you can use the [SELECT] button to select the MIDI messages assigned to the scene and use the REALTIME CONTROLS [1], [2], [3], and [4] knobs to send messages to your external MIDI device.

When the external function is on, the REALTIME CONTROLS [1], [2], [3], and [4] knobs operate independently, and are not affected by the settings of Program, Combination, or Multi mode.

---

### Sending MIDI information from the various controllers

When you operate a controller of the microX, the corresponding or specified control change will be transmitted via MIDI. Pitch bend messages are transmitted only when you operate the joystick.

In Program mode, these messages are transmitted on the global MIDI channel.

For details on the MIDI messages transmitted when you operate a microX controller, and on the AMS (Alternate Modulation Source) and DMS (Dynamic Modulation Source) corresponding to the MIDI messages, see “MIDI transmission when the X50/microX’s controllers are operated” (PG p.166).



# Simple program editing

You can edit any of the Programs shipped with microX, or you can start with an initialized Program to create sounds from scratch.

On the microX, you can use the eight sliders in the Performance Editor display and the realtime controller knobs and switches of the front panel to make simple changes to a program without having to enter the editing pages that contain the detailed editing parameters.

## Performance Edit

By using the eight sliders of the Performance Editor, you can make overall adjustments to the sound.

When you move a slider, multiple program parameters are adjusted simultaneously, meaning that you can edit multiple parameters by adjusting a single slider.

1. In Program mode (PROG 0: Play page), select the program that you want to edit.
2. Press the [PAGE+] button (or [PAGE-] button) to access the PROG 0: Play, Perform. Edit page.

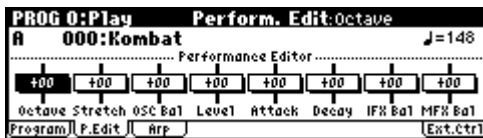

3. Use the ClickPoint [◀][▶][▲][▼] to select the performance editor parameter you want to adjust.
4. Use the [VALUE] dial etc. to adjust the value. (⌘p.20)

**Octave:** Indicates the octave setting.

**Pitch Stretch:** Simultaneously adjusts the transpose and tune settings of the oscillator. This allows you to produce a variety of tonal changes without losing the character of the original sound.

This is particularly effective for acoustic-type programs such as guitar, bass, or piano. Select various programs and try this out.

**OSC Balance:** Adjusts the level balance between oscillators 1 and 2.

*Note:* For programs whose “Mode (Oscillator Mode)” (PROG 1: Ed-Basic, Prog Basic page) setting is **Single**, oscillator 2 will not sound. Only the level of oscillator 1 will change. For a **Drums** program, this performance editor will have no effect.

**Amp Level:** Indicates the amp level. This will adjust the volume of the entire program.

**Attack Time:** Indicates the attack time of the filter EG and amp EG. This will adjust the speed of the attack from note-on.

*Note:* In order to maximize the effect of the Attack Time adjustment, the amp EG Start Level, Attack Level, Start Level Modulation, and Attack Time Modulation parameters are also adjusted.

**Decay Time:** Indicates the decay time and slope time of the filter EG and amp EG.

**IFX Balance:** This simultaneously adjusts the “W/D (Wet/Dry)” balance of all insert effect.

**MFX Balance:** This simultaneously adjusts the Return 1 and 2 parameters of the master effects.

*Note:* Depending on the settings of the program parameters, the result may not be noticeable.

5. If you want to save the modified sound, select the utility menu command “Write Program,” and write the program. (⌘p.45)

⚠ The edited content will be lost if you select another program or turn off the power before saving.

## REALTIME CONTROLS [1], [2], [3], [4], [SELECT]

The REALTIME CONTROLS [1]–[4] knobs can be used to edit parameters such as the filter cutoff frequency, resonance, the amp and filter EGs, volume, portamento time, pan, LFO speed and more. Three different modes - A, B, and C - allow each knob to control one of three separate parameters.

The REALTIME CONTROLS [1]–[4] knobs can transmit MIDI messages (as specified by the external control setup) to your external MIDI equipment. If you turn the [EXT. CONTROLLER] button on (lit), these knobs will be switched to the external control function, and will be disconnected from the internal sound generator. For more about external control, see “External control settings” (⌘p.111).

1. Press the REALTIME CONTROLS [SELECT] button to switch the function of the realtime controllers to A-mode, B-mode, or C-mode. Each time you press the button, A-mode, B-mode or C-mode will be selected alternately, and the corresponding LED will light.

*Note:* If CC#70–79 are assigned to REALTIME CONTROLS A-mode or B-mode, the sound edited by knobs [1]–[4] can be saved by the Program Write operation (p.45).

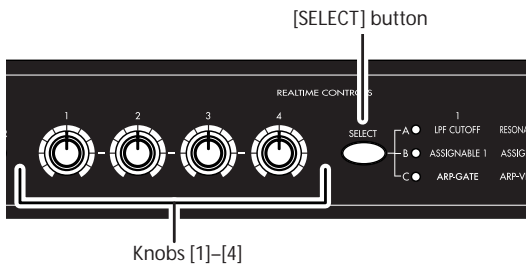

2. Rotate the desired knob to control the sound, etc. See the explanations that follow.

## A-mode controls

In A-mode, knobs [1]–[4] will control/edit the following functions.

*Note:* Placing the knobs in the center (12 o'clock) position will produce the values specified by the program parameters.

### Knob [1]: LPF CUTOFF

Adjust the cutoff frequency of the low pass filter.

When you adjust the cutoff frequency of the filter, the brightness of the sound will change. The effect will depend on the settings of the program parameters, but normally, rotating the knob toward the left will darken the sound, and rotating it toward the right will brighten it.

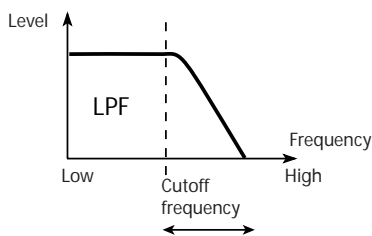

### Knob [2]: RESONANCE/HPF

Adjust the resonance level of a low pass filter or the cutoff frequency of a high pass filter.

The content that is controlled will depend on the filter type specified by the program.

By adjusting the filter resonance level, you can increase or decrease the resonance level to add a unique character to the sound.

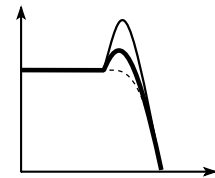

Adjusting the cutoff frequency of the high-pass filter will modify the thickness of the sound from which the low frequency range has been filtered out.

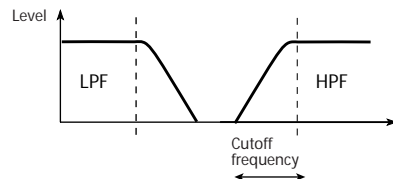

### Knob [3]: EG-INTENSITY

Adjust the filter EG intensity (the depth at which the filter EG is applied).

Rotating the knob will affect the depth of the filter EG. Normally, rotating the knob toward the left will make the filter EG apply less deeply, and rotating it toward the right will make the filter EG apply more deeply. Since the filter EG will operate based on the cutoff frequency of the filter, knobs [1] and [3] will work together to control the tonal changes produced by the filter.

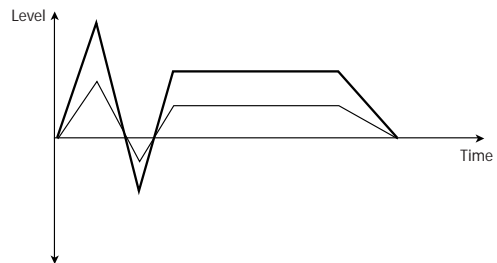

### Knob [4]: EG-RELEASE

Adjust the EG release times of the filter and amp. This will determine the time from note-off until the sound disappears.

When you adjust the knob, the release times of the filter EG and the amp EG will change. Normally, rotating the knob toward the left will shorten the release time, and rotating it toward the right will lengthen the release time.

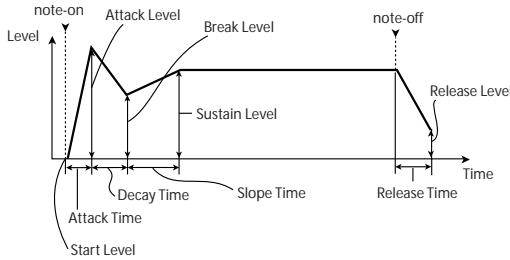

*Note:* If the display indicates “Memory Protected,” the program memory protect is turned on. Go to GLOBAL 0: System, Preference page, and uncheck the Memory Protect “Program” setting. (p.88)

## B-mode controls

You can control parameters such as volume, portamento time, pan or filter and amp EG, pitch LFO, and master effect send levels etc.

The B-mode function settings are made for each individual program, combination, or multi set.

You can specify the B-mode functions separately for each individual program, combination, or multi set.

The B-mode functions of the REALTIME CONTROLS [1], [2], [3], and [4] knobs can be viewed for Program mode in the 0: Play, Program page, for Combination mode in the 0: Play, Combination page, and for Multi mode in the 0: Play, Multi page. (p.37)

Each knob in B-mode can also be used as a source for Alternate Modulation or Effect Dynamic Modulation to control program parameters or effect parameters, allowing you to adjust the sound in a wide range of ways.

## C-mode control

You can control the effect of the arpeggiator in realtime.

For details on operation, see p.91.

## Saving your edits

Once you’ve tweaked the sound to perfection, you’ll want to save your work. To save your edits:

 Be aware that if you modify the sound of a program or write it to a different bank or number, and then use a combination that uses the modified program, the combination will sound different.

1. Press the [UTILITY] button to access the utility menu.
2. Use the ClickPoint to select “Write Program,” and then press the ClickPoint center.

The Write Program dialog box will appear.

3. Optionally, you can also select a new location, or change the Program’s name.
  - If you want to change the bank and number of the writing destination, use the ClickPoint to select the program name located at the right of the “To,” and use the [VALUE] dial to select the desired writing destination.
- If you want to change the name, use the ClickPoint to select the text button (T) and then press the ClickPoint center to open the text edit dialog box.

*Note:* You can’t save in banks G or g(d).

You can give the Program a descriptive name using the on-display keyboard. (p.114)

After entering the name, press [MENU/OK] button.

The text edit window will disappear, returning you to the main Write dialog.

- If you want to specify the category, use the ClickPoint to select “Category,” and use the [VALUE] dial to specify the desired category.

The category you specify here can be used when selecting by category with the [CATEGORY] button.

You can select by Category in the following pages.

- PROG 0: Play page
- COMBI 0: Play, Prog page “Program Select”
- COMBI 1: Ed-Tone Adjust, Prog page
- MULTI 0: Play, Program page.

4. In the Write Program dialog box, press the [MENU/OK] button to write (save) the program.
5. A message will ask you for confirmation. If you are sure you want to write the program, press the [MENU/OK] button once again. The program will be written (saved).

# Detailed Editing with Programs

You can create your own original sounds by editing the factory Programs, or by initializing a Program (Bank E 127: Init. Program) and starting from scratch. You can save these Programs into any bank other than Bank G or g(d), which cannot be modified.

## Before you begin editing

### The three attributes of sound: pitch, tone, and volume

Sound has three basic attributes; pitch, tone, and volume.

To control these attributes, the microX provides “oscillator,” “filter,” and “amp (amplifier)” sections.

The “oscillator” settings vary the pitch, the “filter” settings modify the tone, and the “amp” settings modify the volume.

### The microX’s “oscillator,” “filter,” and “amp”

On the microX, the settings that determine the “pitch” are located in the PROG 1: Ed-Basic and PROG 2: Ed-Pitch pages. In the Ed-Basic page you can specify the waveform (multisample) and the basic pitch of the waveform. In the Ed-Pitch page you can specify how the pitch will follow the keyboard, and make other pitch-related settings.

“Filter” settings are made in the PROG 4: Ed-Filter1 and PROG 5: Ed-Filter2 pages. These settings adjust the tone.

Finally, “Amp” settings are made in the PROG 6: Ed-Amp1/2 pages. These settings adjust the volume, and send the sound to the outputs.

### Program structure and corresponding pages

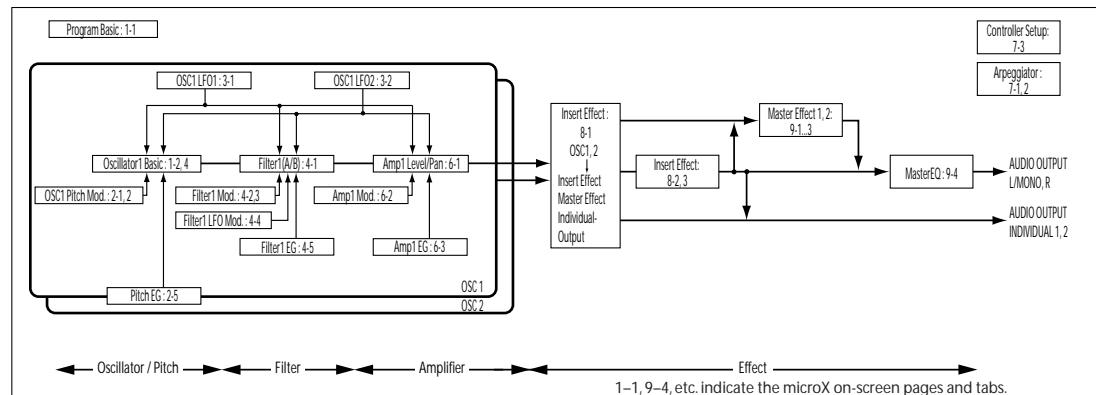

These three sections determine the basic sound of the program.

### EG, LFO, keyboard tracking, AMS, Dmod, controllers

In addition to the sections described above, the microX provides ways in which the sound can be varied according to time, key range, or various types of performance expression. These are controlled by modulators and controllers such as EG (envelope generator), LFO (Low Frequency Oscillator), keyboard tracking, AMS (Alternate Modulation Source), Dmod (Dynamic modulation) and the joystick. You can use these modulators and controllers to apply change to the basic sound of the program.

Take a look at the diagram entitled “Program structure and corresponding pages.” Notice that the audio signal flows in the order of Oscillator/Pitch → Filter → Amp. Also notice how modulators such as EG and LFO can affect these blocks.

As shown in figure, a program consists of OSC 1/2, effects, and the arpeggiator.

### OSC 1/2

Each timbre consists of Oscillator/Pitch, Filter, Amp, EG, and LFO blocks. You can create more complex programs by using two oscillators together in one program using the Layer feature.

*Note:* The Pitch EG is shared by OSC1 and OSC2.

### EFFECTS

The output of OSC 1/2 is sent to the insert effect, the master effects, and the master EQ. The mixer section lets you control the routing, so you can specify where the sound will be sent.

For the one insert effect and the two master effects, you can choose from 89 effect types. The master EQ is a stereo three-band EQ.

## ARPEGGIATOR

A program can use one arpeggiator. You can select an arpeggio pattern, specify the range in which the arpeggio will be generated, and specify the range of notes (keys) and velocities that will trigger the arpeggiator.

## Overview of editing pages

In the PROG 0: Play page you can select and play programs, and use the performance editor or real-time controllers to make simple edits to the sound. You can also adjust the arpeggiator settings.

The other pages let you modify the sound in more detailed ways.

0: Play	<ul style="list-style-type: none"> <li>• Select and play programs.</li> <li>• Use the Performance Editor for easy editing, and to do simple editing of arpeggio patterns.</li> <li>• Select an external control set.</li> </ul>
1: Ed-Basic	<ul style="list-style-type: none"> <li>• Specify the program type as Single, Double, or Drum.</li> <li>• Select multisamples.</li> <li>• Specify Mono or Poly voice assignment.</li> <li>• Select the temperament (e.g., equal temperament).</li> </ul>
2: Ed-Pitch	<ul style="list-style-type: none"> <li>• Pitch settings. Pitch EG settings.</li> </ul>
3: Ed-LFOs	<ul style="list-style-type: none"> <li>• Type and speed settings etc. for the two LFOs provided for each oscillator. (Make settings in the pitch, filter, and amp pages to specify the depth of the LFO settings you make here.)</li> </ul>
4: Ed-Filter1	<ul style="list-style-type: none"> <li>• Filter (tone) settings. Filter EG settings.</li> </ul>
5: Ed-Filter2	
6: Ed-Amp1/2	<ul style="list-style-type: none"> <li>• Settings related to Amp 1/2 (volume), including amp EQ and pan (stereo position).</li> </ul>
7: Ed-Arp/Ctrls	<ul style="list-style-type: none"> <li>• Arpeggiator settings. (Shared with 0: Play parameters. You may edit either.)</li> <li>• Controller settings.</li> </ul>
8: Ed-InsertFX	<ul style="list-style-type: none"> <li>• Select the BUS and master effect send level for the oscillator output.</li> <li>• Insert Effect routing, selection and settings.</li> </ul>
9: Ed-MasterFX	<ul style="list-style-type: none"> <li>• Master Effect selection and settings. Master EQ settings.</li> </ul>

For details on how to access each mode, page, and the utility commands, and how to edit values, see “Basic operations” (p. 19).

## Comparing (original and edited sounds)

When you're in the process of editing a sound, pressing the [COMPARE] button will recall the saved version of the sound, as it was before you started editing. To indicate that you are listening to the saved version, the button's LED will light up.

Pressing [COMPARE] button again returns you to the version you are editing, and the LED will go out again.

If you edit while the COMPARE LED is lit, the button will again go dark and your previous edits will be lost.

## Basic oscillator settings

### Program type setting (single, double, drum kit)

Here you can specify the type of program (whether to use one oscillator, two oscillators, or a drum kit). Use the PROG 1: Ed-Basic, Prog Basic “Oscillator Mode” to specify the program type.



Single Programs have one oscillator, and Double Programs have two oscillators. Each oscillator includes a complete synthesis voice, with velocity-switched Multisamples, dual filters, EGs, LFOs, and so on.

Drums mode is a special variation of Single mode, and uses a Drum Kit (as created in Global mode) instead of Multisamples.

### Polyphony

Polyphony is the number of notes that can be played simultaneously, such as in a chord. The polyphony depends on the program type.

Program type	Polyphony
Single	62
Double	31
Drums	62

### Polyphonic/monophonic playing

The Voice Assign Mode selects whether the Program will play polyphonically (**Poly**) or monophonically (**Mono**).



When this is set to **Poly**, you can play both chords and melody lines. When this is set to **Mono**, only one note will sound even if you play a chord. Normally you'll set this to **Poly**, but **Mono** is useful when playing sounds such as synth basses, synth leads, and other solo instruments. Another important aspect of monophonic playing is Legato triggering. When Legato is on (the box is checked), if a new note on the keyboard is played before the previous note is released, the filter and amplifier

EGs will not re-trigger, so that you can move from note to note in a true legato fashion. If the previous note is released before the next note is played, the note will trigger normally.

Try switching between Poly and Mono, and listen to the results.

## Working with Multisamples

### What is a multisample?

A sample is a digital recording of a particular instrument or waveform (or other natural or artificially processed sound) recorded at a specific pitch. A multisample is a collection of similarly voiced samples, used to create the same type of sound - piano, bass, guitar, strings, organ - across the entire keyboard, as the basis of a program. The oscillators of single and double programs use multisamples. There are 624 multisamples available in this instrument.

You can assign up to two multisamples to each oscillator and switch between them by velocity. This is called “velocity multisample switching.”

### Multisamples and Drum Kits

Multisamples and Drum Kits allow you to play samples in different ways.

- Multisamples lay out one or more samples across the keyboard. For instance, a very simple guitar Multisample might have six samples—one for each string.
- As the name suggests, Drum Kits are optimized for playing drum samples.

### Selecting Multisamples

If you specify a High and Low multisample for an oscillator, either the High or the Low multisample will sound depending on the velocity of the note (i.e., the strength at which you play the keyboard). This function is called **velocity multisample switching**.

*Note:* To make it easier for you to hear the result, set the program type to “Oscillator Mode” Single.

1. Access the PROG 1: Ed-Basic, OSC1 page.
  2. Use the ClickPoint [**◀**][**▶**][**▲**][**▼**] to highlight “High Multisample.”
- Use the [VALUE] dial to make your selection.

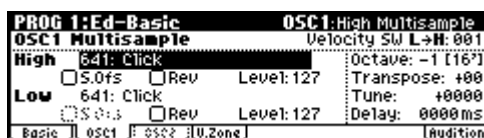

- Alternatively, you can select a multisample by category.

With “High Multisample” highlighted, press the [CATEGORY] button to access the category menu. (p.38)

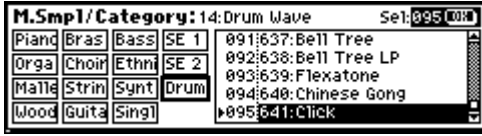

Use the [PAGE+]/[PAGE-] buttons to select a category.

Then use the [VALUE] dial to select a multisample.

Press the [MENU/OK] button to finalize your selection.

- Specify the basic pitch of the oscillator. This is set by the “Octave” parameter.
- In the same way, select a different multisample for “Low Multisample.”

You have now assigned the “High” and “Low” multisamples. Next we’ll set the velocity range.

- Specify a velocity value for “Velocity SW L→H.”

Notes played on the keyboard at a velocity less than the value you specify will sound the **Low** multisample; velocities at or above this velocity value will sound the **High** multisample.

For example if you set “**Velocity SW L→H**” to **100**, playing the keyboard softly will sound the “Low” multisample, and playing strongly will sound the “High” multisample.

- Adjust the “Level” for High and Low multisamples to set their volume balance.

*Note:* If you do not wish to use this function, set the “**Velocity SW L → H**” value to **001**. Only the High multisample will sound.

### Reverse check box

**Reverse** lets you play the selected multisample backwards, without looping. This can produce interesting results for sound effects or other unusual timbres. Normally you will **not check** this.

### Using oscillators 1 and 2 to create a detuned sound

You can use a double program (i.e., a program whose “Oscillator Mode” is Double) to create a detuned sound as follows.

- Make the same multisample and EG settings, etc. for OSC1 and OSC2.

It will be convenient to use the Utility “Copy Oscillator” to make the oscillator settings match each other.

- Specify the playback pitch for OSC1 and OSC2.

The playback pitch can be set independently. By using the same multisample with slightly different “Tune” settings, you can “detune” the oscillators to produce a richer sound. Generally speaking, people hear flat notes as sounding “sour” or out of tune more easily than they do sharp notes. So when detuning two oscillators, it may sound more musical to tune one oscillator up in pitch, and leave the other oscillator close to or just slightly below normal pitch.

### Using velocity to switch between oscillator 1 and 2

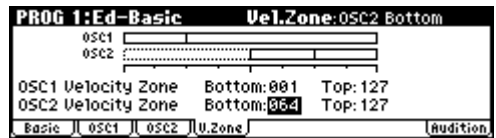

Here you can specify the range of velocities that will sound oscillators 1 and 2.

In the example shown above, the velocity ranges are as follows.

- OSC1 will sound for all velocity values.
- OSC2 will sound only for strongly played notes (64 and above).
- You can use Velocity Multisample Switching in addition to this (“High Multisample, Low Multisample”). For this example, set “OSC1” in “**Velocity SW L→H**” to **32** and “OSC2” to **96**. The settings are shown as vertical lines in the velocity zone display.

In this example, the multisamples will sound over four levels.

**Velocity values 001–031:** sound only the OSC1 Low multisample.

**Velocity values 032–063:** sound only the OSC1 High multisample.

**Velocity values 064–095:** sound the OSC1 High multisample and the OSC2 Low multisample.

**Velocity values 096–127:** sound the OSC1 High multisample and the OSC2 High multisample.

## Copying settings between OSC1 & OSC2

Many of the Program parameters can be set differently for OSC1 and OSC2.

These include all of the parameters on:

- All of the tabs on the Ed-Pitch page, except for the Pitch EG
- All of the tabs on the Ed-Filter page
- All of the tabs on the Ed-Amp page
- All of the tabs on the Ed-LFOs page

You can use the utility menu's Copy Oscillator command to copy these parameters from one Oscillator to another. You can even copy parameters from an Oscillator in a different Program.

This command is useful when you want to set both Oscillators to the same settings, or when you want to duplicate settings you've used before.

## Assigning a drum kit

### What is a drum kit?

If you want to use a drum kit in a program, set the "Oscillator Mode" to Drums. Then choose one of the 40 user drum kits or nine GM-compatible drum kits for the program to use.

A drum program uses a "drum kit" for its oscillator. A drum kit consists of multiple drum instrument samples placed across the keyboard. There are 929 drum instrument samples. (see p.48 "Multi-samples and Drum Kits")

In Global mode you can create or edit a drum kit itself. You can assign up to two drum samples (High and Low) to each note of the keyboard, and switch between these drum samples by velocity. You can also specify the effects and the routing to the audio output jacks. (see p.108 "Editing Drum Kits")

### Selecting a drum kit

1. Access the PROG 1: Ed-Basic, Prog Basic page.
2. Set "Oscillator Mode" to Drums.



3. Access the PROG 1: Ed-Basic, OSC1 page.
4. Use the ClickPoint [◀][▶][▲][▼] to highlight "Drum Kit."

Use the [VALUE] dial to select a drum kit.

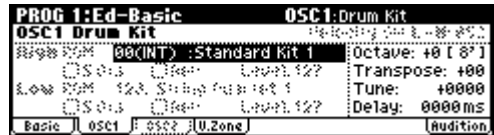

5. Specify the basic pitch of the oscillator. For a drum kit, set "Octave" to +0 [8].

## Using LFOs and Envelopes (EGs)

### Using LFOs

Each Oscillator has two LFOs: LFO1 and LFO2.

You can use these LFOs to modulate many different Program parameters, including:

- Pitch (vibrato): PROG 2: Ed-Pitch, OSC1 LFO "Intensity," and the same parameter of the OSC2 LFO
- Filter (wah effect): PROG 4: Ed-Filter1, LFO Mod. "Intensity to A" and "to B," and the same parameters for PROG 5: Ed-Filter2
- Volume (auto-tremolo): PROG 6: Ed-Amp1/2, Mod, LFO1 Mod. "Intensity," and the same parameters for LFO2 Mod.

In addition to the uses described above, you can use an LFO as a source for Alternate Modulation and Effect Dynamic Modulation to modulate a wide range of parameters. By assigning an LFO to "Pan AMS" (PROG 6: Ed-Amp1/2, Level/Pan) you can create an auto-pan effect.

### Basic LFO settings

*Note:* Depending on the program you've selected, you may be unable to hear the result of the following edits. If so, increase the value of one of the "Intensity" parameters listed above so that you can hear the result.

For example in order to use OSC1 LFO1 to modulate filter 1, you should increase the PROG 4: Ed-Filter1, LFO Mod. LFO1 "Intensity to A" or "Intensity to B" value.

1. Access the PROG 3: Ed-LFOs, OSC1 LFO page.



2. Select the "Waveform" parameter.
3. Use the [VALUE] dial etc. to select the desired LFO waveform.

The display shows a graphic of the waveform.



There are a number of waveforms to choose from. Each are suited to different applications:

**Triangle** and **Sine** are the classic LFO shapes for vibrato, tremolo, panning, and filter wah effects.

**Square** is useful for gated filter and amp effects, and creates a police siren effect when modulating pitch.

The **Guitar** waveform is designed especially for guitar vibrato, since it bends only upwards from the base value.

**Saw** and **Exponential Saw Down** are good for rhythmic filter and amp effects.

**Random 1 (S/H)** creates the classic sample-and-hold effect, which is great for modulating a resonant filter.

4. After looking at the different waveforms, select Triangle.
5. Use the “Frequency” parameter to set the speed of the LFO.
6. Use the “Fade” and “Dly” (Delay) settings to control the way the LFO sounds at the beginning of the note.

For more information on LFOs, see “PROG 3: Ed-LFOs” (PG p.14).

All of these parameters control the way that the LFO itself works. In order for the LFO to actually affect the sound, you can use the dedicated LFO routings on the Filter, Pitch, and Amp pages, or use the LFOs as AMS sources for a wide variety of parameters.

## Frequency Modulation

AMS can be used to vary the LFO speed. This lets you change the LFO speed by operating a controller, or by the EG or Keyboard Track settings. (PG p.14)

## MIDI/Tempo Sync.

If “MIDI/Tempo Sync” is **checked**, the “Frequency” setting will be ignored, and the LFO will synchronize to the system tempo, as set by the TEMPO knob or external MIDI clocks.

This lets you produce vibrato, wah, auto-pan, or tremolo effects that lock to arpeggiator, or external MIDI sequencers.

## EGs (Envelope Generators)

An envelope creates a modulation signal by moving from one level to another over a specified time, and then moving to another level over another period of time, and so on.

Each program includes three EGs, one for Pitch, one for the Filter, and one for the Amp. These produce time-varying changes in pitch, tone, and volume respectively. They can also be used to modulate a number of other Program parameters via AMS.

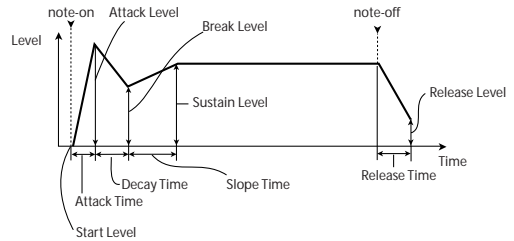

## Using Alternate Modulation

AMS (Alternate Modulation Source) refers to any of the assignable modulation sources in microX, including:

- Built-in physical controllers, such as the Joystick, and Real-Time Knobs
- Incoming MIDI controllers
- Modulators such as the Filter, Pitch, and Amp EGs, or the LFOs

**Intensity** is a parameter that sets the degree (speed, depth, amount etc.) to which AMS will control the modulation.

A number of frequently-used modulation routings, such as using the joystick to vary the pitch, are provided as additional, dedicated routings, separate from AMS.

Note that not all AMS sources may be available for some modulation destinations.

For details on alternate modulation and AMS, see “Alternate Modulation Source (AMS)” (PG p.151).

## Suggestions on using AMS

When making settings for alternate modulation, think of the effect that you wish to produce, what type of modulation will be necessary to produce that effect, and what parameter of the oscillator, filter, or amplifier needs to be controlled.

Next, select a source (AMS) and set the **Intensity**. If you proceed logically in this way, you will achieve the desired effect.

For example, if you want to control a guitar sound so that it approaches feedback when you move the joystick, you might set up the joystick to modulate the filter frequency and resonance.

## Controlling Pitch

Here you can specify how the pitch of the multi-sample selected for the oscillator will change. Pitch EG and LFO settings allow the pitch to varied over time.

*Note:* To specify the basic pitch of the multisample, use the “Octave” parameter in the PROG 1: Ed-Basic, OSC1 or OSC2 page.

### Varying the pitch according to keyboard position (Pitch Slope)

On keyboard instruments such as piano or organ, the pitch will rise as you play toward the right side of the keyboard, and fall as you play toward the left.

You can use the “Pitch Slope” setting to specify how this will occur.

With positive (+) settings, the pitch will rise as you play toward the right side of the keyboard. With negative (-) settings, the pitch will fall as you play toward the right side of the keyboard. Normally you will leave this set to +1.0.

### Modulating the pitch

PROG 2:Ed-Pitch		OSC1 Pitch Slope	
<b>Pitch</b>	Pitch Slope: +1.0	JS(+X): +02	AMS: Off
	Ribbon(#16): +00	JS(-X): -02	Intensity: +00.00
<b>Pitch EG</b>	Intensity: +00.00	AMS: Off	Intensity: +00.00
<b>Portamento</b>	<input checked="" type="checkbox"/> Enable	<input type="checkbox"/> Fingered	Time: 085
osc1   0511f0   osc2   0521f0   EG			

### Pitch bend

The JS (+X) and JS (-X) settings specify the amount of pitch change (in semitones) that will occur when MIDI pitch bend messages are received or when the joystick is moved to left or right. A setting of +12 allows the pitch to be controlled a maximum of one octave upward; a setting of -12 allows the pitch to be controlled a maximum of one octave downward.

“Ribbon (#16)” specifies the amount of pitch change (in units of a semitone) that will occur when CC#16 is received (or when you operate the ribbon controller of a connected TRITON Extreme or similar device).

### Portamento

Portamento makes the pitch change smoothly when you play the next note before releasing the previous note.

The “Time” parameter controls how long it take the pitch to change. As this value is increased, the

pitch will change over a longer time. With a value of 000, there will be no portamento.

### Creating Vibrato

You can use an LFO to create vibrato.

**LFO 1/2 Intensity** sets the depth to which the selected LFO will affect the pitch. With a setting of +12.00, vibrato will produce a maximum of ±1 octave of pitch change.

“JS+Y Int” specifies the amount of vibrato that the LFO will produce when the joystick is pushed away from yourself.

“AMS Intensity” specifies the depth of the vibrato effect created by LFO when you operate an AMS (Alternate Modulation Source). For example, suppose you set “LFO1 AMS” to KnobM1 [+] (Knob Mod1: CC#17), and raise the “AMS Intensity.” If Knob B Assign “Knob 1-B” is set to Knob Mod.1 (CC#17), vibrato will be applied when you turn the microX’s knob [1] or when CC#17 is received.

PROG 2:Ed-Pitch		OSC1 LFO: LFO1 Intensity	
<b>Pitch LFO1/2 Modulation</b>			
<b>LFO1</b>	Intensity: +00.15	AMS: KnobM1 [+]	Intensity: +00.10
	JS+Y Int: +00.00	AMS: MIDI After T	Intensity: +00.00
<b>LFO2</b>	Intensity: -00.05	AMS: MIDI After T	Intensity: +00.00
	JS+Y Int: +00.00	AMS: MIDI After T	Intensity: +00.00
osc1   0511f0   osc2   0521f0   EG			

### Pitch EG

When the **Intensity** value is set to +12.00, the pitch EG specified in the Pitch EG page will produce a maximum of ±1 octave of pitch change.

To realistically simulate the slight change in pitch that occurs when a string is plucked or at the attack of a brass or vocal sound, you can use the EG to create a subtle change in pitch at the attack.

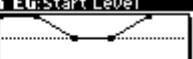
PROG 2:Ed-Pitch		Pitch EG: Start Level	
<b>L</b>	S: +99 A: +99	R: +99	
<b>T</b>	A: +99 D: +99	R: +99	
<b>Level Mod.</b>			
AMS1: Off	I: +00 S: 0 A: 0	Time	AMS: SW 1 #00
AMS2: Off	I: +00 S: 0 A: 0	Mod.	I: +99 A: + D: +
osc1   0511f0   osc2   0521f0   EG			

## Using Filters

The filters allows you to diminish or emphasize specified frequency areas of the sound.

**The tone of the sound will depend significantly on the filter settings.**

microX provides Filter1 for OSC1 and Filter2 for OSC2. For each of these filters, you can select from two types (**Low Pass Resonance or Low Pass & High Pass**). Filter2 can be used if “**Mode (Oscillator Mode)**” is set to **Double**.

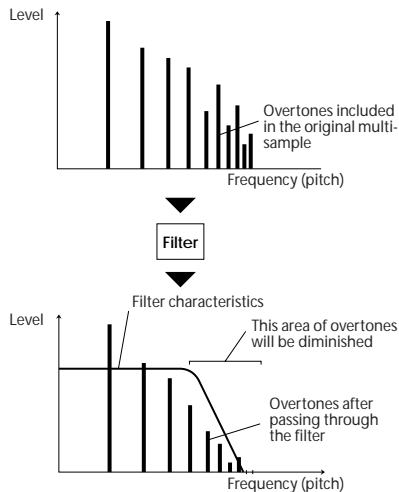

## Filter Types

This selects the parts of the sound which will be affected by the filter, as described below.

### Low pass filter

This is the most common type of filter, which passes the low frequency range and cuts the high frequency range. When the overtones of the high range are cut, a bright sound will become darker (more mellow).

24 dB/oct and 12 dB/oct see the steepness of the cut. **24 dB/oct** means that the gain will decrease 24 dB in one octave (i.e., as the frequency doubles). A **12 dB/oct** filter would decrease the gain 12 dB in one octave. The 24 dB/oct filter produces a steeper cut.

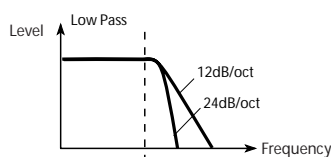

### High pass filter

This type of filter passes the high frequency range and cuts the low frequency range. Use this when you wish to make the sound thinner. However if the cutoff frequency (Frequency) is raised excessively high, the volume will become very low.

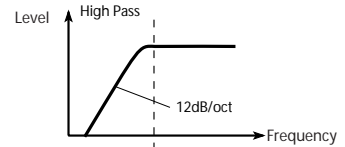

## Resonance

When “**Resonance**” is set to a higher value, the overtones in the region of the cutoff frequency will be boosted as shown in the diagram below, giving a distinctive character to the sound.

When resonance is applied

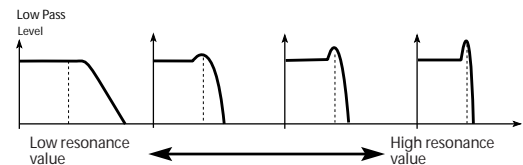

When this is set to 0, there is no emphasis, and frequencies beyond the cutoff will simply diminish smoothly.

At medium settings, the resonance will alter the timbre of the filter, making it sound more nasal, or more extreme. At very high settings, the resonance can be heard as a separate, whistling pitch.

To make the resonance track the keyboard pitch, see “4-2a: Keyboard Track” (PG p. 17).

## Selecting a filter to modify the tone

Here’s how to select a filter type and adjust the “Frequency” (cutoff frequency) and “Resonance” (resonance level).

1. Use “Type” to select a filter type.

**Low Pass Resonance:** This is a 24 dB/octave low pass filter with resonance.

**Low Pass & High Pass:** This is a 12 dB/octave low pass filter and a 12 dB/octave high pass filter connected in series.

2. If you’ve selected Low Pass Resonance as the filter type, you can set the parameters for Filter A.

“Frequency” specifies the cutoff frequency. Overtones above the specified cutoff frequency will be diminished, making the tone more mellow (darker).

“Resonance” specifies the resonance level. This boosts the overtones in the region of the specified “Frequency,” giving the sound a distinctive character.

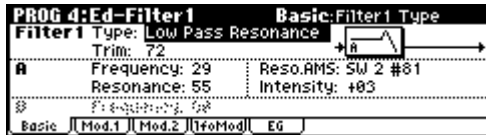

If you’ve selected Low Pass & High Pass as the filter type, you can use the Filter A parameters to adjust the low pass filter and the Filter B parameters to adjust the high pass filter.

Overtones above the Filter A “Frequency” will be diminished, making the sound more mellow (darker).

Overtones below the Filter B “Frequency” will be diminished, decreasing the low-range and making the sound thinner.

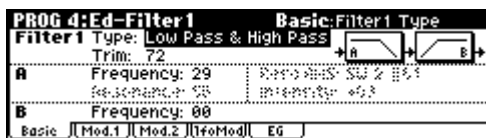

## Modulating the filters

You can modulate the filter cutoff frequency using the Filter EG, the LFOs, keyboard tracking, and other built-in and MIDI controllers. This is a great way to add a rich variety of tonal change to the sound.

### Keyboard Track

Most acoustic instruments get brighter as you play higher pitches. At its most basic, keyboard tracking re-creates this effect by increasing the cutoff frequency of a lowpass filter as you play higher on the keyboard. Usually, some amount of key tracking is necessary in order to make the timbre consistent across the entire range.

- When Ramp “**Low**” is set to a positive (+) **value**, the cutoff frequency will rise as you play lower on the keyboard, making the sound brighter. When set to a negative (-) **value**, the cutoff frequency will fall as you play lower on the keyboard, making the sound darker.
- When Ramp “**High**” is set to a positive (+) **value**, the cutoff frequency will rise as you play higher on the keyboard, making the sound brighter. When set to a negative (-) **value**, the cutoff frequency will fall as you play higher on the keyboard, making the sound darker.

- “**Int. to A**” and “**Int. to B**” adjust the effect that keyboard tracking will have on filters A and B.

For more details, see “4-2a: Keyboard Track” (PG p. 17).

### Filter EG

The Filter EG is a multi-stage envelope, which you can use to modulate the filter (naturally!) as well as other Program parameters. The EG itself is set up on the Filter page; the way that it affects the filters is controlled by the parameters described below, on the Filter Mod page:

The “**Int. to A**” and “**Int. to B**” settings control the basic amount of EG modulation for filter frequencies A and B, respectively, before other modulation.

The “**Vel to A**” and “**Vel to B**” settings let you use velocity to scale the amount of EG modulation.

The “**AMS**” setting selects a AMS modulation source to scale the amount of the Filter EG applied to Filters A and B. The two filters share a single AMS source, with separate intensity settings.

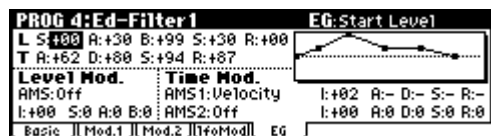
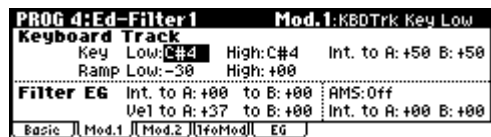

### LFO modulation

You can modulate the filter via LFO1 and LFO2. Among other applications, LFO modulation of the filter can produce the classic “auto-wah” effect. The Ed-Filter1, LFO Mod (or Ed-Filter2) page lets you set up the following parameters separately for each LFO:

“**Intensity to A**” and “**Intensity to B**” specify how much the LFO changes the tone.

“**JS-Y Int. to A**” and “**JS-Y Int. to B**” specify the depth of the wah effect created by the LFO when you move the joystick toward yourself or when CC#2 is received.

The “**AMS**” setting selects a AMS modulation source to scale the amount of the LFO applied to Filters A and B. The two filters share a single AMS source, with separate intensity settings.

For example if you set Knob B Assign “Knob 1-B” to Knob Mod. 1 (CC#17), and set “AMS” to Knob M1#17, you can turn the REALTIME CONTROLS B-mode knob [1] to apply an auto wah effect.

<b>PROG 4:Ed-Filter1</b>		<b>LFO Mod.:LFO1 Int. to A</b>	
<b>Filter LFO1/2 Modulation</b>			
<b>LFO1</b>		Intensity to A: +00 to B: +00 AMS:KnobM1#17	
JS-Y Int. to A: +00 to B: +00		Int. to A: +30 B: +00	
<b>LFO2</b>		Intensity to A: +00 to B: +00 AMS:Off	
JS-Y Int. to A: +10 to B: +00		Int. to A: +00 B: +00	
Basic	Mod.1	Mod.2	TroMod EG

### AMS modulation

In addition to the EG, LFOs, and Key Track, you can use two AMS sources to modulate the filters. For instance, you could use the joystick to change the brightness.

<b>PROG 4:Ed-Filter1</b>		<b>Mod.2:Filter A AMS1</b>	
<b>Filter Modulation</b>			
<b>Filter-A</b>		AMS1: JS X Intensity: +30	
AMS2: KnobM2#19		Intensity: +10	
<b>Filter-B</b>		AMS1: JS X Intensity: +00	
AMS2: MIDI AfterT		Intensity: +00	
Basic	Mod.1	Mod.2	TroMod EG

## Using the Amp section

The Amp section includes controls for volume and pan. You can control the volume using the Amp EG, LFO 1/2, Keyboard Track, and velocity, along with other AMS sources.

Each Oscillator has its own Amp section: Amp1 for OSC1, and Amp2 for OSC2.

Different sounds have characteristic shapes to their volume levels.

For example, the volume of a piano note begins at a high volume the instant you play the note, and then decreases gradually.

The volume of an organ note, on the other hand, remains constant as long as you continue pressing the key.

The volume of a note on a violin or wind instrument can be varied during the note by the musician (i.e., by regulating the amount of pressure on the bow or the force of the breath).

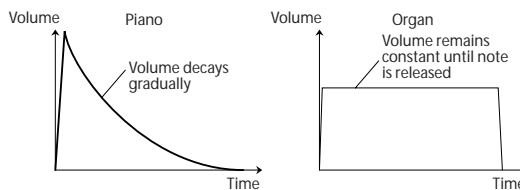

### Setting the basic amp level

The basic volume level is set by the “Amp Level” parameter.

You can then alter this using the modulation sources below:

<b>PROG 6:Ed-Amp1/2</b>		<b>Level/Pan:Amp1 Level</b>	
<b>Amp1</b>		Level: 127	
<b>Pan</b>		Pan: C064 AMS:Off	
Intensity: +00		Intensity: +00	
Amp1	Mod.	Amp2	Mod. EG

### Applying modulation to the amp

<b>PROG 6:Ed-Amp1/2</b>		<b>Mod.:KBOTrk Key Low</b>	
<b>Keyboard Track</b>			
Key Low: C4		High: C4	
Ramp Low: +10		High: -10	
<b>Amp Mod.</b>		Velocity Int: +48 AMS:Pitch EG Int: +22	
<b>LFO1 Mod.</b>		Intensity: +00 AMS:Off Int: +00	
<b>LFO2 Mod.</b>		Intensity: -40 AMS:KnobM1#17 Int: -40	
Amp1	Mod.	Amp2	Mod. EG

### Keyboard Track

This lets you vary the volume relative to the note you play.

For more details, see “Keyboard Track” (p.54).

### Velocity (Amp Modulation)

**Velocity Intensity** is used by most programs to decrease the volume of softly played notes and increase the volume of strongly played notes.

Normally you will set Amp Modulation to positive (+) values. As this setting is increased, there will be greater volume difference between softly played and strongly played notes.

### LFO1/2 Mod.

Specifies how the LFO’s will produce cyclic changes in volume (tremolo effect).

The volume will be affected by the LFO(s) for which you set an LFO1 Mod Intensity, LFO2 Mod Intensity value.

**Intensity** (AMS Intensity) adjusts the depth by which the tremolo effect produced by the LFO will be affected when you assign an AMS (LFO1 AMS, LFO2 AMS).

For example if you set “AMS” (LFO1 or LFO2) to JS-Y #02, you can move the joystick toward yourself or receive CC#2 to apply a tremolo effect.

### Amp EG (Amp Envelope Generator)

The Amp EG lets you control how the volume changes over the course of a note.

<b>PROG 6:Ed-Amp1/2</b>		<b>EG:Start Level</b>	
<b>L S: +99</b>		A: +99 B: +00 S: +00	
<b>T R: +17</b>		D: +99 S: +00 R: +60	
<b>Level Mod.</b>		<b>Time Mod.</b>	
AMS: Off		AMS1: Off	
I: +00 S: 0 A: 0 B: 0		I: +00 A: 0 D: 0 S: 0 R: 0	
AMS2: Off		I: +00 A: 0 D: 0 S: 0 R: 0	
Amp1	Mod.	Amp2	Mod. EG

Every instrument has its own characteristic volume envelope. This is part of what gives each instrument its identifiable character. Conversely, by changing the volume contour—for instance, applying a string-like Amp EG curve to an organ multisample—you can produce interesting and unusual sounds.

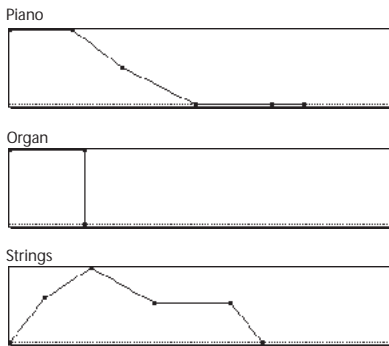

### Adjusting the pan (stereo position)

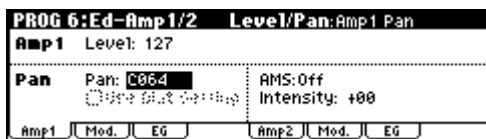

The main “Pan” parameter determines the placement of the sound in the stereo field after the signal has passed through the oscillator, filter, and amp.

Normally you’ll set this to **C064**, so that the sound is centered equally between the left and right speakers.

To create a stereo effect when “Oscillator Mode” is set to **Double**, set the Amp1 “Pan” to L001, and the Amp2 “Pan” R127. This will make OSC1 go to the left speaker, and OSC2 go to the right speaker.

With a setting of **Random**, the pan will change randomly each time you play a note on microX, producing an interesting effect.

### Pan AMS and Intensity

“Intensity” specifies the depth of the pan modulation from the selected AMS source.

If you set **AMS** to **Note Number**, the pan will change according to the keyboard position of each note played.

With a setting of **LFO1** or **2**, the sound will sweep from side to side, creating an auto-pan effect.

### Pan - Use DKit Setting

**Use DKit Setting** applies when “Oscillator Mode” is set to **Drums**.

If this is **checked**, the Program can use a different pan position for each drum sound, as specified by the Drum Kit. If this is **unchecked**, all drum sounds will use the Program’s pan position. The factory presets and GM drum kits use individual pan positions for the different drums, so normally it’s best to leave this checked.

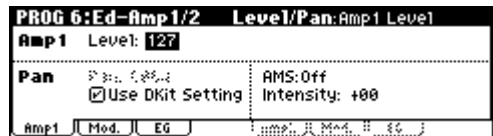

## Effects

Effects are covered in their own section of the manuals, so we won’t go into too much detail here. (p.79)

### Insert Effect

You can make insert effect settings in the PROG 8: Ed-InsertFX page.

The Insert Effect can be assigned to either an individual oscillator or the entire Program. You can use any type of effects, from distortions and compressors to choruses and reverbs.

The Insert Effect can be routed to the main outputs, or to any of the individual outputs. (p.84)

### Master Effects

You can make master effect settings in the PROG 9: Ed-MasterFX page.

There are two Master Effects, which are accessed through Sends 1 and 2. These are best-suited to effects such as reverbs and delays, but you can use them with any type of effect. (p.85)

### Master EQ

You can make master EQ settings in the PROG 9: Ed-MasterFX page.

The master EQ is located immediately before the (MAIN OUTPUT) L/MONO and R outputs. Use it to adjust the overall tone. (p.85)

# Playing and Editing Combinations

## What's a Combination?

Combinations, or “Combis” for short, let you split and layer up to 8 Programs at once.

A Combi is made up of 8 Timbres. Each Timbre has a Program, along with parameters for key and velocity zones, mixer settings, MIDI channel and

controller filtering, and so on.

As with Programs, each Combi has 1 Insert Effect, 2 Master Effects, and a Master EQ, for shaping and transforming the sounds of the individual Timbres. Finally, Combis can use 2 Arpeggio patterns modules at once.

## Playing combinations

### Selecting combinations

There are several different ways to select Combinations. Each one is convenient in a different way:

#### • Selecting combinations from the front panel:

##### Using “Combi Select” to select a program

- Turn the [VALUE] dial.
- Press the center of the ClickPoint to highlight the field, then use [▲][▼] to select a program, and press the center to finalize your selection.
- Use the COMBINATION [A]–[C] buttons to select a combination bank.

##### Selecting combinations by program category

You can select programs by categories such as piano or drums. (p.38)

#### • Selecting combinations by using a foot-switch:

You can change combinations even while both hands are busy playing on the keyboard - convenient for live applications

#### • Selecting combinations by receiving MIDI program changes:

You can switch combinations from an external MIDI sequencer or an external MIDI controller.

See below for details.

### Selecting combinations from the front panel

1. Press a COMBINATION [A]–[C] button. (The button will light.)

You will enter Combination mode, and the bank you specified will be selected. Notice that the upper line of the display indicates “COMBI 0: Play” (mode name, page number and name). The bank number you specified is shown below “COMBI 0: Play.”

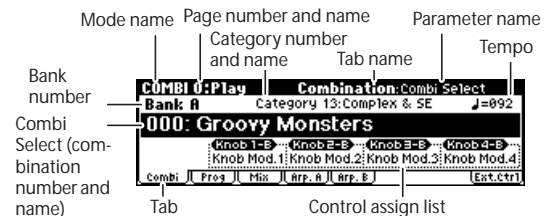

2. Make sure that “Combi Select” (combination number and name) is selected.

If this is not selected, use the ClickPoint [▲][▼] to highlight the “Combi Select” indication.

3. Use the [VALUE] dial etc. to select the combination you want to play.

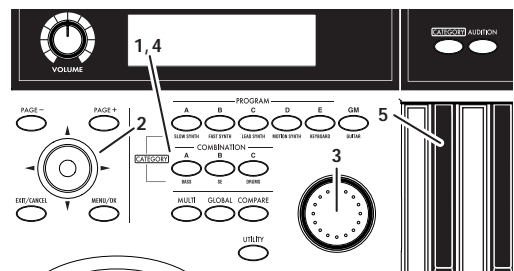

You can use either of the following methods to select a program.

- Turn the [VALUE] dial.

- Press the center of the ClickPoint to highlight the field, then use [▲][▼] to select a program, and press the center to finalize your selection.
4. Press a COMBINATION [A]–[C] button to switch banks.

When you select a different Bank, the button's LED will light, and the selected bank will appear on the left side of the display.

For example, to select bank B, press the COMBINATION [B] button. The [B] button will light, and the name Bank B will appear in the left of the display.

### Auditioning the sound

5. Play a note on the keyboard to hear the sound you selected.

*Note:* You can't use the [AUDITION] button to play a riff (phrase) in Combination mode.

### Overview: Combination Banks

When shipped from the factory, it is loaded with 384 Combinations. You can also save any combinations that you create.

Combinations are organized into three banks as shown in the following table.

#### Combination banks

Bank	Prog. No.	Explanation	
A, B, C	000... 127	for preloaded combination	With the factory settings, these banks contain a wide variety of preloaded combinations that use multiple programs, effects, and arpeggio patterns. 128 programs can be written or rewritten to each bank A–C (for a total of 384). You can't write (save) data in these banks.

### Selecting by Category

You can select Combinations from within a category, such as keyboard, synthesizer, bass, and drums.

When shipped from the factory, the preloaded Combinations are organized into 16 categories.

For details on how to do this, refer to “Using [CATEGORY] and the PROGRAM/COMBINATION buttons to select” (p. 38).

### Using a footswitch to select Combinations

You can assign a footswitch to step through Combinations one by one, either going up (0, 1, 2, 3, etc.) or going down (3, 2, 1 etc.).

This lets you change Combinations without using your hands—great for quick Combination changes in live performance situations.

For details on how to do this, refer to “Using a footswitch to select Programs” (p. 39).

### Using MIDI program changes to select combinations

You can select combinations in the COMBI 0: Play page or switch the programs of timbres by sending MIDI program change messages from your external MIDI device (DAW software or other sequencer, or MIDI controller) to the microX.

If you've installed the included “microX Plug-In Editor” into your DAW program as a plug-in, you can easily select microX programs or combinations from a list within your DAW software. For more details, see “Editor/Plug-In Editor Manual” (PDF).

### Switching combinations via MIDI

The combination will change when the microX receives a program change on a channel that matches the global MIDI channel.

However, this is affected by the GLOBAL 1: MIDI “Combi (Combination Change)” setting. This setting must be checked. If this setting is unchecked, the combination will not change; instead, the program will change for the timbre of the matching channel.

With the factory settings, the global MIDI channel is set to channel 1. If you want to change this setting, see “MIDI channel setting” (p. 39).

### Switching the program of a timbre via MIDI

The MIDI channel of a timbre is specified by the COMBI 2: Ed-Track Param, MIDI “MIDI Channel” setting. When a program change message on a MIDI channel that matched the timbre's channel is received, the program will change for timbres whose “Status” is INT. However, program changes for timbres are affected by the COMBI 3: Ed-MIDI Filter1, -1 page “Program Change” setting.



The “Status” setting is located in the COMBI 2: Ed-Track Param, MIDI page, and the “Program Change” setting is located in the COMBI 3: Ed-MIDI Filter1, -1 page.

The result of receiving a program change on the global MIDI channel will depend on the GLOBAL 1: MIDI “Combi (Combination Change)” setting.

---

## Using Controllers

Just as in Program mode, you can use controllers such as the joystick, OCTAVE [▼][▲] buttons, and REALTIME CONTROLS [1]–[4] to add a broad range of expression to your playing in Combination mode.

These controls let you modify the tone, pitch, volume, effects, etc. in realtime while you play.

For more details, see “Using Controllers” (PG p.59). REALTIME CONTROLS [1], [2], [3], and [4] will also function as external controls.

---

## Sending MIDI information from the various controllers

When you select a combination on microX, a MIDI program change for the selected combination number will be transmitted on the global MIDI channel. At the same time, bank select, program change, and volume (CC#7) messages will be transmitted on the MIDI channel specified for each timbre that is set to “Status” of **EXT** or **EX2**. However, these messages will not be transmitted for timbres that are set to the same MIDI channel as the global MIDI channel. In this case, **EX2** timbres will show the “Program Select” Bank as “-”, and will transmit the bank number that was specified in “Bank (EX2) MSB” and “Bank (EX2) LSB” (2-1a).

MIDI messages transmitted when you operate microX are transmitted on the global MIDI channel. At the same time, timbres whose “Status” is **EXT** or **EX2** will transmit the same messages on their own MIDI channel.

For details on the MIDI messages transmitted when you operate an microX controller, and on the AMS (Alternate Modulation Source) and DMS (Dynamic Modulation Source) corresponding to the MIDI messages, see “MIDI transmission when the X50/microX’s controllers are operated” (PG p.166).

## Simple combination editing

You can edit any of the Combinations shipped with microX, or you can start with an initialized Program to create sounds from scratch.

On the microX, you can use the edit of COMBI 0: Play page and the realtime controller knobs and switches of the front panel to make simple changes to a program without having to enter the editing pages that contain the detailed editing parameters.

## Changing the programs within the Combination

Changing the Program assigned to each timbre (1–8) is a quick way to dramatically alter the sound of the Combination.

*Note:* You can make the following settings from either the COMBI 0: Play page or the 1: Ed–Tone Adjust page.

### Selecting programs from the front panel and LCD

To change the Program assigned to a Timbre:

1. Access the COMBI 0: Play, Prog page.

This page shows information about the programs assigned to Timbres 1–8.



2. Use the ClickPoint to highlight “Program Select,” and use the [VALUE] dial etc. to select a program.

You can use either of the following methods to select a program.

- Turn the [VALUE] dial.
- Press the center of the ClickPoint to highlight the field, then use [▲][▼] to select a program, and press the center to finalize your selection.
- “Selecting by Category” (p. 38)

### Listening to the program sound of just one timbre

Here’s how you can listen to the sound of a single timbre by itself.

1. Press the [UTILITY] button to access the utility menu.



2. Use the ClickPoint [▲][▼] to choose “Solo Selected Timbre,” and press the ClickPoint center.

Now you will hear only the program sound of the currently selected timbre. The lower part of the display will indicate [Solo].



3. To cancel this setting, choose “Solo Selected Timbre” once again and press the ClickPoint center.

## Receiving MIDI changes to switch timbre programs

See “Switching the program of a timbre via MIDI” (p. 58).

*Note:* MIDI program changes only work for Timbres whose Status is set to INT.

## Adjusting a timbre’s pan and volume

### Adjusting the pan (stereo position)

Here’s how to adjust the pan of each timbre.

1. Access the COMBI 0: Play, Mixer page.

This page shows the pan and volume settings for the programs assigned to timbres 1–8.



2. Use the ClickPoint [◀][▶][▲][▼] to highlight the “Pan” of the timbre whose pan setting you want to adjust, and use the [VALUE] dial etc. to adjust the setting.

A setting of **C064** is center, **L001** is far left, and **R127** is far right. With a setting of **RND**, the stereo location will change randomly between left and right each time a note is played.

## Adjusting the volume

Here's how to adjust the volume of each timbre.

1. Access the COMBI 0: Play, Mixer page.
2. Use the ClickPoint [◀][▶][▲][▼] to highlight the "Volume" of the timbre whose volume setting you want to adjust, and use the [VALUE] dial etc. to adjust the setting.

## Adjusting the volume while preserving the volume balance between timbres

1. Press the [UTILITY] button to access the utility menu.



2. Use the ClickPoint [▲][▼] to select "Hold Balance," and press the ClickPoint center.

The upper right of the display will indicate "Hold Bal."



3. When you change the "Volume" value of any timbre, the volume of all timbres will also change to preserve the volume balance at the time you checked the Hold Balance setting.
4. To defeat this setting, press "Hold Balance" once again and press the ClickPoint center.

## REALTIME CONTROLS [1], [2], [3], [4], [SELECT]

Just as in Program mode, you can use the realtime controller [1]–[4] knobs and [SELECT] button in Combination mode to modify sounds and effects, or to control the arpeggiator. See "REALTIME CONTROLS [1], [2], [3], [4], [SELECT]" (p. 43).

The REALTIME CONTROLS [1]–[4] knobs can transmit MIDI messages (as specified by the external control setup) to your external MIDI equipment. If you turn the [EXT. CONTROLLER] button on (lit), these knobs will be switched to the external control function, and will be disconnected from the internal sound generator. For more about external control, see "External control settings" (p. 111).

*Note:* The REALTIME CONTROLS A-mode and B-mode can control timbres of the same channel as the global MIDI channel.

## Saving your edits

Once you've tweaked the sound to perfection, you'll want to save your work. To save your edits:

1. Press the [UTILITY] button to access the utility menu.
2. Use the ClickPoint to select "Write Combination," and then press the ClickPoint center.

The Write Combination dialog box will appear.

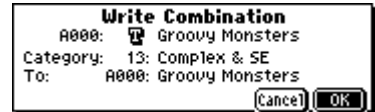

*Note:* If the display indicates "Memory Protected," the combination memory protect is turned on. Go to GLOBAL 0: System, Preference page, and uncheck the Memory Protect "Combination" setting. (p. 88)

3. Optionally, you can also select a new location, or change the Combination's name.
  - If you want to change the bank and number of the writing destination, use the ClickPoint to select the combination name located at the right of the "To," and use the [VALUE] dial to select the desired writing destination.
  - If you want to change the name, use the ClickPoint to select the text button (T) and then press the ClickPoint center to open the text edit dialog box.

You can give the Combination a descriptive name using the on-screen keyboard. (p. 114) After entering the name, press [MENU/OK] button.

The text edit window will disappear, returning you to the main Write dialog.

- If you want to specify the category, use the ClickPoint to select "Category," and use the [VALUE] dial to specify the desired category. The category you specify here can be used when selecting by category with the [CATEGORY] button. (p. 58)
4. In the Write Combination dialog box, press the [MENU/OK] button to write (save) the program.
5. A message will ask you for confirmation. If you are sure you want to write the program, press the [MENU/OK] button once again.

The combination will be written (saved).

# Detailed Editing with Combinations

You can edit any of the preloaded combinations or start with an initialized Combination (Bank C 127: Init. Combination) to create your own original sounds.

You can use the factory Programs to create new Combinations, or use your own custom Programs. You can write (save) these combinations in any bank A–C.

## Before you begin editing

A combination has eight timbres. Each timbre consists of a program with parameters such as keyboard zone, velocity zone, mixer settings, MIDI channel, and filter. See the diagram entitled “Combination structure and corresponding pages.”

## Overview of Combi mode parameters

### Select a program for each timbre

In the COMBI 0: Play, Prog page (or COMBI 1: Ed–Tone Adjust, Prog page), select a program for each timbre.

### Status and MIDI settings

In the COMBI 2: Ed–Track Param, MIDI page, set “Status” to INT for the timbres that you want to play, and set their MIDI channel to the global MIDI channel.

### Layer, split, and velocity switch

In the COMBI 5: Ed–Key Zone, Key page and the 6: Vel Zone, Vel page, specify the range (layer, split, velocity switching, etc.) in which each program will sound.

### Adjust the programs so that they fit within the combination

For each timbre program, specify the poly/mono setting and adjust timbre parameters such as portamento and transpose.

### Effects

The output of each timbre is sent to the insert effect, the master effects, and the master EQ. You can use the mixer section to freely specify how the audio signals will be routed.

There is one insert effect and two master effects, and for each of these you can choose one of 89 effect types. The master EQ is a stereo three-band EQ.

*Note:* The effect settings created and saved with a program in Program mode are not used in Combination mode. Effect settings are made independently for the combination.

### Arpeggiator

A combination can use two arpeggiators (dual polyphonic arpeggiators). You can select the arpeggio pattern, specify the range in which the arpeggio is generated, and specify the region of notes (keys) or velocities that will trigger the arpeggiator.

Combination structure and corresponding pages

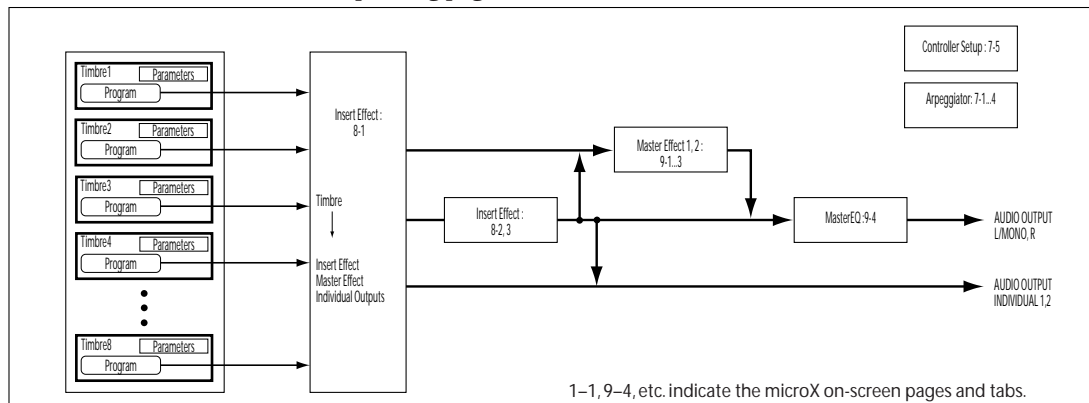

## Overview of editing pages

In the COMBI 0: Play page you can select and play combinations, select the program used by each timbre, adjust the mixing, and adjust the arpeggiator setting.

The other pages let you modify the sound in more detailed ways.

0: Play	<ul style="list-style-type: none"> <li>• Select and play combinations.</li> <li>• Select a program for each timbre, and set status, pan, and level. (Same as the 1: Ed-Tone Adjust parameters; can be edited from either page.)</li> <li>• Select an arpeggio pattern and make settings.</li> <li>• Select an external control set.</li> </ul>
1: Ed-Tone Adjust	<ul style="list-style-type: none"> <li>• Select a program for each timbre, and set status, pan, and level.</li> <li>• Use Tone Adjust to adjust parameters.</li> </ul>
2: Ed-Timbre Param	<ul style="list-style-type: none"> <li>• MIDI, OSC, Pitch, Delay, and Scale settings for each timbre.</li> </ul>
3: Ed-MIDI Filter1	<ul style="list-style-type: none"> <li>• MIDI message transmission/reception filter settings for each timbre.</li> </ul>
4: Ed-MIDI Filter2	
5: Ed-Key Zone	<ul style="list-style-type: none"> <li>• Key zone settings for each timbre.</li> </ul>
6: Ed-Vel Zone	<ul style="list-style-type: none"> <li>• Velocity zone settings for each timbre.</li> </ul>
7: Ed-Arp/Ctrls	<ul style="list-style-type: none"> <li>• Arpeggiator settings. (Same as the 0: Play parameters; can be edited from either page.)</li> <li>• Controller settings.</li> </ul>
8: Ed-InsertFX	<ul style="list-style-type: none"> <li>• BUS and master effect send level settings for each timbre.</li> <li>• Insert Effect routing, selection, and settings.</li> </ul>
9: Ed-MasterFX	<ul style="list-style-type: none"> <li>• Master Effect selection and settings.</li> <li>• Master EQ settings.</li> </ul>

For details on how to access each mode, page, and the utility commands, and how to edit values, see “Basic operations” (p. 19).

## Comparing (original and edited sounds)

When you’re in the process of editing a sound, pressing the [COMPARE] button will recall the saved version of the sound, as it was before you started editing. To indicate that you are listening to the saved version, the button’s LED will light up.

Pressing [COMPARE] button again returns you to the version you are editing, and the LED will go out again.

If you edit while the COMPARE LED is lit, the button will again go dark and your previous edits will be lost.

## Selecting a program for each timbre

You can select a program for each timbre in the COMBI 0: Play, Prog page or in the COMBI 1: Ed-Tone Adjust, Prog page.

For the procedure, see “Changing the programs within the Combination” (p. 60)

## Status and MIDI settings

### “Status” and MIDI channel

#### Status

This controls the status of MIDI and the internal tone generator for each Timbre. Normally, if you’re playing an internal Program, this should be set to **INT**.

If the status is set to **Off**, **EXT**, or **EX2**, that internal sounds will not be played. **Off** simply disables the Timbre entirely. The **EXT** and **EX2** settings allow the Timbre to control an external MIDI device.

#### Bank Select (when status=EX2)

When the **Status** is set to **EX2**, these parameters allow you to transmit MIDI Bank Select messages for changing banks on external MIDI devices.

#### MIDI Channel

Timbres that you wish to play from microX’s keyboard must be set to the global MIDI channel.

Your playing on the keyboard is transmitted on the global MIDI channel, and will sound any timbre that matches this channel. Normally you will set this to **Gch**. When this is set to **Gch**, the MIDI channel of the timbre will always match the global MIDI channel, even if you change the global MIDI channel.

 On some preloaded combinations, Timbres used by arpeggiator may have their MIDI Channels set to something other than **Gch**. These will be timbres that play only when arpeggiator is on—a very useful technique for creating “arpeggiator-utilized” combinations. For more details, see “The arpeggiator in Combination and Multi modes” (p. 95). In particular, note the relationships between arpeggiator assignments and MIDI Channel.

## MIDI filter settings

Here you can specify whether the MIDI data sent and received by timbres 1–8 will be filtered.

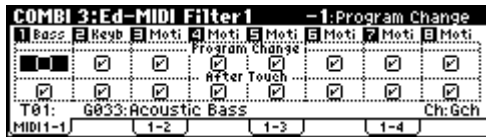

If a check box is checked, the corresponding MIDI data can be sent and received. If “Status” is INT, movements of the microX’s controllers or incoming MIDI data will apply an effect for the program of that timbre. (Effect Dynamic Modulation functionality is not affected by these settings.) If the “Status” is EXT or EX2, movements of the microX’s controllers will transmit MIDI data on the channel of that timbre. MIDI transmit/receive settings for the entire microX are made in “MIDI Filter” (GLOBAL 1).

If a check box is unchecked, the corresponding MIDI data will not be sent or received.

As another example, let’s say that you’ve selected a bass Program for Timbre 1, and a piano Program for Timbre 2, with the goal of creating a bass/piano split. You could make the following settings so that pressing the damper pedal affects only Timbre 2’s piano sound:

1. Access the COMBI 3: Ed-MIDI Filter1, -2 page.
2. Un-check the Damper CC#64 box for Timbre 1.
3. Check the Damper CC#64 box for Timbre 2.

## Layers, Splits, and Velocity switches

Within a Combination, you can use note number and velocity to determine which Timbres will sound.

The Programs assigned to each Timbre can sound in three ways: as part of a **layer**, a **split**, or a **velocity switch**. A Combination can be set to use any one of these methods, or to use two or more of these methods simultaneously.

### Layer

Layers cause two or more Programs to sound simultaneously when a note is played.

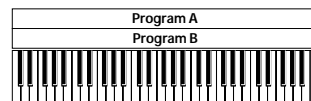

Layer:  
Two or more programs sound simultaneously.

### Split

Splits cause different Programs to sound on different areas of the keyboard.

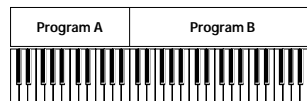

Split:  
Different programs will sound in different areas of the keyboard.

### Velocity Switch

Velocity Switches cause different Programs to sound depending on the velocity (how hard you play the notes).

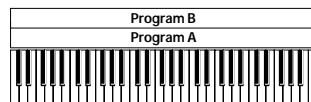

Strong ↑ Keyboard playing dynamics  
Soft ↓  
Velocity Switch:  
Keyboard playing dynamics (velocity) switches between different programs.

On microX, you can use a different Program for each of up to eight Timbres, and combine two or more of the above methods to create even more complex setups.

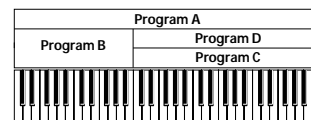

Strong ↑ Keyboard playing dynamics  
Soft ↓  
Example:  
B and C/D are split. In the lower keyboard range, A and B are layered. In the higher keyboard range, C and D are switched by velocity and layered with A.

As an additional possibility, you can set the slope for a key zone or velocity zone so that the volume diminishes gradually. This lets you change a split into a keyboard crossfade, or a velocity switch into a velocity crossfade.

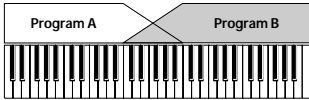

Keyboard X-Fade (keyboard crossfade): As you play from low notes to high notes, the volume of A will fade out, and the volume of B will fade in.

## Creating Key Splits and Layers

Let's create a Combi which combines both splits and layers, like the diagram below:

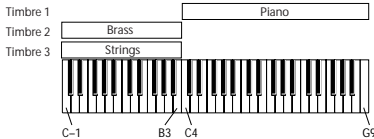

1. Access the COMBI 0: Play, Prog page.
2. Select a piano sound for Timbre 1, a brass sound for Timbre 2, and a strings sound for Timbre 3.
3. Access the COMBI 2: Ed-Timbre Param, MIDI page.
4. For Timbres 1-3, set Status to INT and MIDI Channel to Gch (the Global Channel).
5. Access the COMBI 5: Ed-Key Zone, Key page.
6. Set Timbre 1's Top Key to G9, and its Bottom Key to C4.
7. Set Timbres 2 and 3 to a Top Key of B3, and a Bottom Key of C-1.

The piano program will sound when you play a key above or including C4. The brass program and strings program will sound when you play a key below C4.

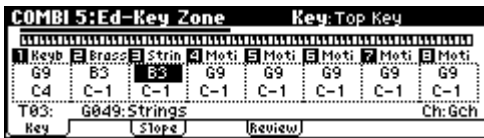

## Key Zone Slope

In addition to "hard" splits, in which the sound changes abruptly, you can use the "Slope" parameters to gradually fade a sound in or out over a range of keys.

We'll assume that you are continuing to edit from the preceding example.

1. Access the COMBI 5: Ed-Key Zone, Slope page.
2. In the example above, you could set the "Bottom Slope" of timbre 1 to 12, and set the "Top Slope" of timbre 2 to 12, so that these two timbres overlap.
3. Access the COMBI 5: Ed-Key Zone, Slope page.
4. Next, if you set the "Bottom Slope" of timbre 1 to 12, and set the "Top Slope" of timbre 2 to 12,

the sound will change gradually instead of changing suddenly.

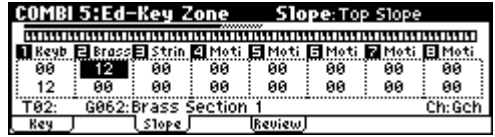

5. The COMBI 5: Ed-Key Zone, Review page shows a graphic indication of the region of keys (or note data) for which timbres 1-8 will play. The region that will sound is shown as a line, and the shaded area indicates the portion occupied by the slope.

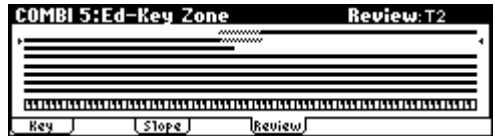

## Creating Velocity Switches

Next, let's create a simple velocity switched Combination, like the diagram below:

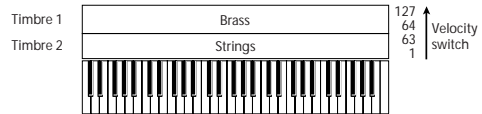

1. Access the COMBI 0: Play, Prog page.
2. Select a brass sound for Timbre 1, and a strings sound for Timbre 2.
3. Access the COMBI 2: Ed-Timbre Param, MIDI page.
4. For Timbres 1-2, set "Status" to INT and MIDI Channel to Gch (the Global Channel).
5. Access the COMBI 6: Ed-Vel Zone, Vel page.
6. Set Timbre 1's Top Velocity to 127, and its Bottom Velocity to 64.
7. Set Timbre 2 to a Top Velocity of 63, and a Bottom Velocity of 1.

The strings program will sound when you play the keyboard softly, and the brass program will sound when you play strongly.

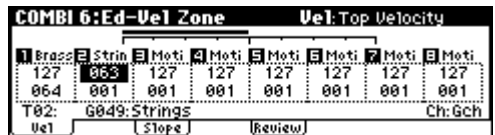

### Velocity Zone Slope

Similar to Key Zone Slopes, as described above, these let you fade in and fade out sounds gradually over a velocity range, instead of a simple hard switch.

We'll assume that you are continuing to edit from the preceding example.

1. Access the COMBI 6: Ed-Vel Zone, Vel page.
2. In the case of the above example, you could set the velocity zones of the two Timbres so that they partially overlap.
3. Access the COMBI 6: Ed-Vel Zone, Slope page.
4. Then, set the "Top Slope" and "Bottom Slope" so that the sound changes gradually, instead of changing suddenly between velocity values of 63 and 64.



5. The COMBI 6: Ed-Vel Zone, Review page shows a graphic indication of the region of velocities for which timbres 1-8 will play. The region that will sound is shown as a line, and the shaded area indicates the portion occupied by the slope.

### Altering Programs to fit within a Combination

You can make various changes to Programs within the context of a particular Combination, to make them fit better with other Programs, or to create particular sonic effects. These changes do not affect the original Programs, or how those Programs sound in other Combinations.

### Specifying how the timbre will sound

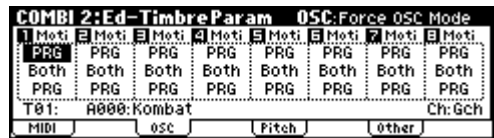

You can make these settings in COMBI 2: Ed-Timbre Param, OSC.

### Force OSC Mode

Normally this should be set to **PRG**, so that the sound will play as set by the original Program.

If you wish to force a polyphonic program to sound monophonically, set this either to **Mono** or **LGT** (Legato). Conversely, set this to **Poly** if you wish to force a monophonic program to play polyphonically.

### OSC Select

Normally, this should be set to **Both**.

If the timbre is using a program whose **Oscillator Mode** is **Double**, and you want only OSC1 or OSC2 (not both) to sound, set this to **OSC1** (only OSC1 will sound) or **OSC2** (only OSC2 will sound).

### Portamento

Normally, this should be set to **PRG**.

If the Program uses portamento, but you'd like to disable this for the current Combination, set this parameter to **Off**.

Conversely, if you want to force the portamento to be on, or just to change the portamento time, set this to a value of **001-127**. The portamento will change to use the newly specified time.



## Adjusting the pitch

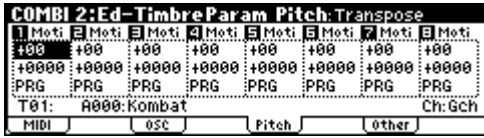

You can make these settings in COMBI 2: Ed-Timbre Param, Pitch.

## Transpose, Detune (BPM Adjust)

These parameters adjust the pitch of the timbre.

- In a layer-type combination, you can set two or more timbres to the same program, and create a richer sound by using “Transpose” to shift their pitch apart by an octave or by using “Detune” to create a slight difference in pitch between the two.
- In split-type combinations, you can use “Transpose” to shift the pitch (in semitone units) of the programs specified for each key zone.
- If you wish to change the playback pitch of a drum program, use “Detune.” If you change the “Transpose” setting, the relationship between notes and drum sounds will change.

## Adjusting the BPM of multisamples

If you’re using a phrase or rhythm loop multisample in the program of a timbre, you can adjust its BPM. You can use the utility menu “Detune BPM Adjust” to call up a new BPM value. This changes the BPM by adjusting the playback pitch. For more details, see “Detune BPM Adjust” (PG p.41).

## Specifying the range of pitch change controlled by the joystick (+X, -X)

This is specified by the “Bend Range.” You can specify the range in semitone units. With the PRG setting, the pitch bend range will be as specified by the program.

## Delay and scale settings



You can make these settings in COMBI 2: Ed-Timbre Param, Other.

## Delay

You can set some Timbres so that they don’t sound immediately at note-on. This can create cool effects, and more dramatic layers.

You can specify the delay for each Timbre either in milliseconds (ms), or in rhythmic values which sync to the system tempo.

If you set the “Delay” to **Key Off**, the Timbre will sound when the note is released.

## Use Program’s Scale

This specifies the scale for each timbre.

If you **check** “Use Program’s Scale,” the scale specified by the program will be used. Timbres for which this is **not checked** will use the Scale setting “Type (Combi scale).”

## Editing Programs with Tone Adjust

Using Tone Adjust, you can make detailed edits to Programs within the context of the Combi. You can assign six parameters to each timbre and adjust them, but you can also re-specify parameters and make further adjustments.

Proceed as follows.

1. Of the COMBI 1: Ed-Tone Adjust, TA1-TA3 pages, access the page that you want to edit.

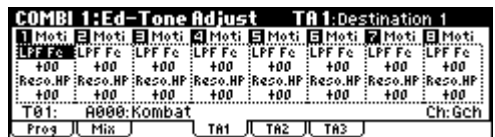

2. For each timbre, use “Destination 1-6” to select the parameter that you want to adjust for the program.
3. Use the [VALUE] dial etc. to adjust the value of the parameter you selected in “Destination 1-6.” The sound will change accordingly.

With the default settings you can control the following parameters.

**LPF Fc:** Adjusts the low pass filter cutoff frequency of program OSC 1/2. This will affect the brightness of the sound.

**Reso.HP:** Adjusts the resonance level of the low pass filter or the cutoff frequency of the high pass filter for program OSC 1/2. The parameter that is controlled will depend on the filter type specified for the program.

**F EG Int:** Adjusts the filter EG intensity (the depth of the filter EG) for program OSC1/2.

**A EG A:** Adjusts the EG attack times of the program OSC 1/2 filter and amp. To maximize the result of this adjustment, the Amp EG sustain level, attack level, start level modulation, and attack time modulation will also be adjusted at the same time.

**A EG D:** Adjusts the EG decay time and slope time of the program OSC 1/2 filter and amp.

**A EG R:** Adjusts the EG release time of the program OSC 1/2 filter and amp.

---

## Effects

Effects are covered in their own section of the manuals, so we won't go into too much detail here. (☞p.79)

---

### Insert Effect

You can make settings for the insert effect in the COMBI 8: Ed-InsertFX page.

The output of each timbre can be sent to the insert effect. You can use any type of effects, from distortions and compressors to choruses and reverbs.

The Insert Effect can be routed to the main outputs, or to any of the individual outputs. (☞p.84)

---

### Master Effects

You can make master effect settings in the COMBI 9: Ed-MasterFX page.

There are two Master Effects, which are accessed through Sends 1 and 2. These are best-suited to effects such as reverbs and delays, but you can use them with any type of effect. (☞p.85)

---

### Master EQ

You can make master EQ settings in the COMBI 9: Ed-MasterFX page.

The master EQ is located immediately before the (MAIN OUTPUT) L/MONO and R outputs. Use it to adjust the overall tone. (☞p.85)

# Using and Editing Multi sets

Multi mode is great when you want the microX to simultaneously play multiple tracks of data from your external MIDI sequencer. This section explains how to use the Multi mode.

You can use the microX as a sixteen-channel multi-timbral sound module. It has sixteen tracks, and you can assign a different sound program to each track, such as track 1 playing the drums, track 2 playing the bass, track 3 playing the piano, and so on.

You can make settings such as volume and pan for each of these tracks. You can also use realtime controllers to vary the sound.

In addition, you can use the arpeggiator and synchronize it to the tempo of your external MIDI sequencer.

The microX can also be used as a master keyboard to control your external MIDI sound modules.

## MIDI considerations

In Multi mode you will normally switch programs and control the volume and pan etc. by sending MIDI messages from your MIDI sequencer or DAW software, but in this section of the manual we'll explain how to make these settings from the microX itself. However, making these settings in the microX does not automatically make these settings a part of the sequence itself.

These settings can be transferred to your MIDI sequencer by sending a data dump from the microX (if your MIDI sequencer can receive exclusive messages) or by using the included "microX Plug-In Editor" software to read this data from the microX. Then you can send these settings from your sequencer back to the microX when needed.

## Selecting a multi set

### Selecting multi sets from the front panel

1. Press a [MULTI] button. (The button will light.)  
You will enter Multi mode. Notice that the upper line of the display indicates "MULTI 0: Play" (mode name, page number and name).

### The "Multi Mode" setting

This setting is located in GLOBAL 0: System, Preference page, "Multi Mode," and you can change it to suit the way in which you're using the microX.

**for Ext-Seq:** Choose this if you're using the microX as a multi-timbral sound module. When you switch multi sets on the microX, program changes and other MIDI messages will not be transmitted even by tracks whose "Status" is EXT or BTH.

**for Master:** Choose this if you're using the microX as a master keyboard. In this case when you switch multi sets on the microX, program changes and other MIDI messages will be transmitted from tracks whose "Status" is EXT or BTH, allowing you to set up your external sound module in this way.

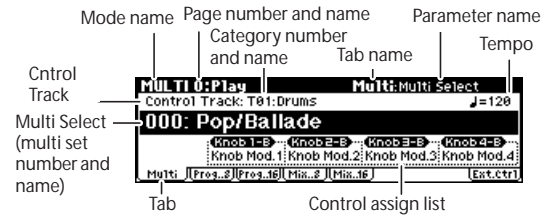

2. Make sure that "Multi Select" (multi set number and name) is selected.
3. Use the [VALUE] dial etc. to select the multi set you want to play.

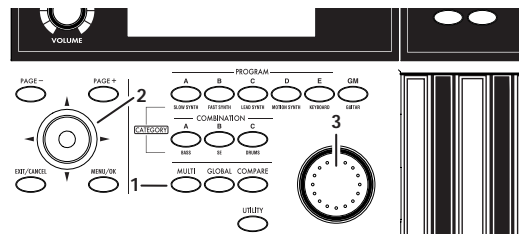

You can use either of the following methods to select a program.

- Turn the [VALUE] dial.
- Press the center of the ClickPoint to highlight the field, then use [▲][▼] to select a multi set, and press the center to finalize your selection.

## Other ways to select a multi set

You can't use a foot switch connected to the ASSIGNABLE SWITCH jack to change multi sets. For details on how to select a multi set via MIDI, see p.77.

## Assigning a program to a track, and setting the volume and pan

### Selecting a track program from the microX

1. Access the MULTI 0: Play, Program page.  
This page shows all 8 Tracks at once, including their Program assignments, volume, pan, play/mute, solo, and more.



2. Use the ClickPoint to highlight "Program Select," and use the [VALUE] dial etc. to select a program.  
You can use either of the following methods to select a program.
  - Turn the [VALUE] dial.
  - Press the center of the ClickPoint to highlight the field, then use [▲][▼] to select a program, and press the center to finalize your selection.
  - "Selecting by Category" (see p.38)

### Checking the sound of a track

#### Playing the microX's keyboard to hear the sound

1. Use the "Control Track" setting to choose the track that will respond to the microX's keyboard.



If "Status" (see p.71 "Status" and MIDI channel") is INT or BTH, you can play the microX's keyboard and operate its controllers to hear the microX's internal tone generator with the settings (program and level etc.) of the track you specified as the "Control Track." Any other tracks that have a matching MIDI channel will also sound at this time. If the "Status" of the track is EXT, EX2, or BTH, the corresponding MIDI messages will be transmitted on the MIDI channel that is specified for that track.

### Receiving MIDI data from an external sequencer to play the microX

By default, the microX's tracks 1 through 16 are set to MIDI channels 1 through 16, with track 1 receiving channel 1, track 2 receiving channel 2, and so on.

1. To hear the track (1) whose "MIDI Channel" setting is 1, transmit performance data (MIDI note-on/off messages) from your external MIDI sequencer on MIDI channel 1.

If the "Status" is INT or BTH, the microX's tone generator will sound. If the "Status" is Off, EXT, or EX2, the microX's tone generator will not sound.

### Silencing a specific track (Mute)

The microX provides a Mute function that lets you temporarily silence the desired track(s) 1-16. For example, you can use this to listen only to the rhythm section while you record a new track. You can also use this function to modify the structure of the song.

1. Access the MULTI 0: Play, Program page.
2. Select the "PLAY/MUTE" and press the ClickPoint center.

Each time you press, the PLAY and MUTE settings will alternate.

If MUTE is selected, this track will not produce sound even if it receives note data from the microX's keyboard or from an external device.



*Note:* The mute setting of each track will not be written (saved).

## Adjusting the pan (stereo position)

Here's how to adjust the pan of each track.

1. Access the MULTI 0: Play, Mixer page.  
This page shows the pan and volume settings for the programs assigned to tracks 1–16.



2. Use the ClickPoint to highlight the “Pan” of the track whose pan setting you want to adjust, and use the [VALUE] dial etc. to adjust the setting.

A setting of **C064** is center, **L001** is far left, and **R127** is far right. With a setting of **RND**, the stereo location will change randomly between left and right each time a note is played.

## Adjusting the volume

Here's how to adjust the volume of each track.

1. Access the MULTI 0: Play, Mixer page.
2. Use the ClickPoint to highlight the “Volume” of the track whose volume setting you want to adjust, and use the [VALUE] dial etc. to adjust the setting.

## “Status” and MIDI channel

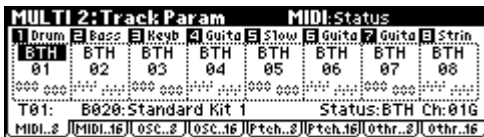

### Status

This specifies the MIDI status of the internal tone generator for each track.

If you want the microX's internal tone generator to sound, choose the INT or BTH setting. These settings let you use your external MIDI sequencer to play the microX as a multi-track sound module. The BTH setting lets you control an external MIDI device at the same time that you play the internal tone generator.

Choose the Off setting for tracks you're not using. With the Off, EXT, or EX2 settings, the internal tone generator will not sound.

With the BTH, EXT, or EX2 settings, you can play an external sound module on the MIDI channel of the “Control Track.”

MIDI data is transmitted and received on the MIDI channel that is specified separately for each track by “MIDI Channel.”

Status	Data from Arp. Operations on the microX		Received data	
	Internal tone generator	MIDI OUT/USB	Internal tone generator	MIDI OUT/USB
INT	●	×	●	—
EXT, EX2	×	●	×	—
BTH	●	●	●	—

For more details, see “Status” (PG p.61).

### Bank select (when Status = EX2)

If the “Status” is EX2, the LSB value and MSB value of the “Bank Select MSB/LSB” will be enabled, and the bank number you specify here will be transmitted via MIDI.

### MIDI channel

This specifies the MIDI channel that the track uses to send and receive note data. If multiple tracks are set to the same MIDI channel, and their “Status” is set to INT, they will all sound and be controlled in the same way when they receive MIDI data.

The “Control Track” setting specifies the track that is played by the microX's keyboard and controlled by its controllers. Data on the “MIDI Channel” of the “Control Track” will play the microX's internal tone generator according its track settings (program, level, etc.) if the track's “Status” is INT or BTH, and will also play any other tracks on the same MIDI channel whose “Status” is INT or BTH. If the “Status” is EXT, EX2, or BTH, these messages will be transmitted on the MIDI channel specified by the track.

### MIDI filter settings

Each MIDI filter item specifies whether the corresponding MIDI message will be transmitted and received. The message can be transmitted and received if the check box is checked. (p.64 “MIDI filter settings”)

## Copying the settings of a combination to a multi set

You can copy the settings of a combination to a multi set. If you have a favorite combination, this function provides a convenient way to copy those sounds to the tracks of a multi set.

*Note:* Set the global MIDI channel (GLOBAL 1: MIDI, “MIDI Channel”) to 01.

1. Select a multi set. (see p.69 “Selecting a multi set”)
2. Choose the “Copy From Combi” utility.

A dialog box will appear.

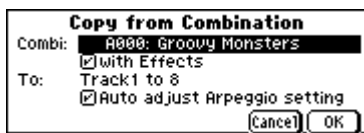

3. Use the “Combi” field to select the combination that you want to copy.
4. If you also want the effect settings of the combination to be copied, check the “With Effects” check box.
5. Specify the tracks of the multi set to which you want the eight timbres of the combination to be copied.

If you want to copy the settings of the combination to tracks 1–8, choose “Track 1 to 8.” If you want to copy them to tracks 9–16, choose “Track 9 to 16.”

6. If you want the sound of the combination including its arpeggiator performance to be recorded on your external MIDI sequencer in order to reproduce the same sounds as when you were recording, you should check the “Auto adjust Arpeggio setting” check box.

This will make adjustments to the MIDI channel and other settings of some tracks, and add tracks as necessary to ensure that the arpeggio performance will be reproduced.

Depending on the settings of the combination, you may need to make additional changes to the track settings.

*Note:* This is available if you’ve selected “Track 1 to 8.” In order to use the “Auto adjust Arpeggio setting” function, the combination you’re copying must have already been written with its [ARP ON/OFF] button turned on.

7. Press the [MENU/OK] button to execute the copy.
8. Set the “Control Track” to 01.

In order to play the sounds and the arpeggiator in the same way as in Combination mode, you must choose a track that is set to the global MIDI channel. Play the keyboard, and you will hear the same sounds as when playing the combination.

9. Begin multi-track recording on your external MIDI sequencer, and operate the microX’s keyboard and controllers.

When you perform multi-track recording, the multiple channels sounded by the arpeggiator will also be recorded at the same time.

10. When you’ve finished performing, stop recording. Play back the recording, and verify that it reproduces the sounds you heard while recording.

## What you can do in Multi mode

A multi set has sixteen tracks. Each track consists of one program, and parameters such as keyboard zone, velocity zone, mixer settings, MIDI channel, and filter settings.

See the illustration “Multi set structure and corresponding pages.”

Multi mode has the following major functions.

- There are 128 multi sets. Each set lets you assign a program to each of the sixteen tracks, and you can combine these programs as splits and layers just as in a combination.
- Each multi set lets you make settings for one stereo insert effect, two master effects, and a stereo master EQ.
- You can use two arpeggiators, and you can synchronize them to your MIDI sequencer.
- By setting the “Status” of a track to INT or BTH, you can play the microX from your external MIDI sequencer as a multi-track sound module. (PG p.55 “Multi Mode”)
- By setting the “Status” of a track to BTH, EXT, or EXT, you can play an external sound module on the MIDI channel of the “Control Track.” (PG p.56 “Multi Mode”)
- You can control the program parameters of a track in realtime using AMS (Alternate Modulation) or control changes. You can also use the MIDI Sync. function to synchronize the LFO speed to the tempo.
- You can use the Dmod (Dynamic Modulation) function to control effect parameters in real-time. You can also use MIDI Sync. to synchronize the LFO speed or delay time to the tempo.
- You can assign a name to the multi set and to each track.

- You can copy the settings of a combination to a multi set.
- The “PLAY/MUTE” setting lets you quickly mute or un-mute a desired track.
- The Tone Adjust function lets you make detailed adjustments to the program used by each track.

## Overview of Multi set parameters

### Select a program for each track

In the MULTI 0: Play, Program page, select a program for each track.

### Status and MIDI settings

In the MULTI 2: Track Param, MIDI page, set “Status” to INT for the tracks that you want to play, and set their MIDI channel to the global MIDI channel.

### Adjust the programs so that they fit within the multi set

For each track program, specify the poly/mono setting and adjust timbre parameters such as portamento and transpose.

### Layer, split, and velocity switch

In the MULTI 5: Key Zone, Key page and the 6: Vel Zone, Vel page, specify the range (layer, split, velocity switching, etc.) in which each program will sound.

### Effects

The output of each track can be sent to the insert effect, the master effects, and the master EQ. You can use the mixer section to freely specify how the audio signals will be routed.

### Multi set structure and corresponding pages

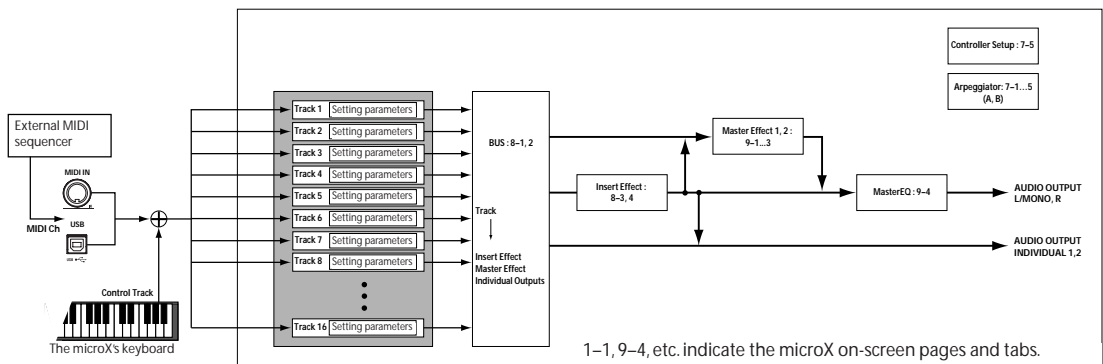

There is one insert effect and two master effects, and for each of these you can choose one of 89 effect types. The master EQ is a stereo three-band EQ.

The effect settings created and saved with a program in Program mode are not used in Multi mode. Effect settings are made independently for the Multi set.

### Arpeggiator

A multi set can use two arpeggiators (dual polyphonic arpeggiators). You can select the arpeggio pattern, specify the range in which the arpeggio is generated, and specify the region of notes (keys) or velocities that will trigger the arpeggiator.

---

### Overview of editing pages

The following pages let you edit a multi set in detail.

0: Play	<ul style="list-style-type: none"><li>• Select a multi set and play the microX's keyboard.</li><li>• Receive and play performance data from an external MIDI sequencer.</li><li>• Select a program for each track, and specify its pan and level.</li><li>• Select an external control set.</li></ul>
1: Tone Adjust	<ul style="list-style-type: none"><li>• Use Tone Adjust to adjust parameters.</li></ul>
2: Track Param	<ul style="list-style-type: none"><li>• MIDI, OSC, Pitch, Delay, and Scale settings for each timbre.</li></ul>
3: MIDI Filter1	<ul style="list-style-type: none"><li>• MIDI message transmission/reception filter settings for each track.</li></ul>
4: MIDI Filter2	
5: Key Zone	<ul style="list-style-type: none"><li>• Key zone settings for each track.</li></ul>
6: Vel Zone	<ul style="list-style-type: none"><li>• Velocity zone settings for each track.</li></ul>
7: Arp/Ctrls	<ul style="list-style-type: none"><li>• Arpeggiator settings.</li><li>• Controller settings.</li></ul>
8: InsertFX	<ul style="list-style-type: none"><li>• BUS and master effect send level settings for each track.</li><li>• Insert Effect routing, selection, and settings.</li></ul>
9: MasterFX	<ul style="list-style-type: none"><li>• Master Effect selection and settings.</li><li>• Master EQ settings.</li></ul>

For details on how to access each mode, page, and the utility commands, and how to edit values, see “Basic operations” (p.19).

---

### Comparing (original and edited sounds)

When you're in the process of editing a sound, pressing the [COMPARE] button will recall the saved version of the sound, as it was before you started editing. To indicate that you are listening to the saved version, the button's LED will light up.

Pressing [COMPARE] button again returns you to the version you are editing, and the LED will go out again.

If you edit while the COMPARE LED is lit, the button will again go dark and your previous edits will be lost.

---

### Using Controllers

Just as in other mode, you can use controllers such as the joystick, OCTAVE [▼][▲] buttons, and REALTIME CONTROLS [1]-[4] to add a broad range of expression to your playing in Combination mode.

These controls let you modify the tone, pitch, volume, effects, etc. in realtime while you play.

REALTIME CONTROLS [1], [2], [3], and [4] will also function as external controls.

---

### Altering Programs to fit within a Multi set

You can make adjustments to the sound of the program for each track, for example by changing the way it plays or by adjusting its pitch or scale.

You can make various changes to Programs within the context of a particular Multi set, to make them fit better with other Programs, or to create particular sonic effects. These changes do not affect the original Programs, or how those Programs sound in other Multi sets. It is the same as for a Combination. For more details, see “Altering Programs to fit within a Combination” (p.66).



## Layers, Splits, and Velocity Switches

You can use keyboard regions and velocity to switch between different tracks in a combination, just as you can in a combination. For more details, see “Layers, Splits, and Velocity switches” (p.64).

## Effects

Effects are covered in their own section of the manuals, so we won’t go into too much detail here. (p.79)

## Insert Effect

You can make settings for the insert effect in the MULTI 8: InsertFX page.

The output of each track can be sent to the insert effect. You can use any type of effects, from distortions and compressors to choruses and reverbs.

The Insert Effect can be routed to the main outputs, or to any of the individual outputs. (p.84)

## Master Effects

You can make master effect settings in the MULTI 9: MasterFX page.

There are two Master Effects, which are accessed through Sends 1 and 2. These are best-suited to effects such as reverbs and delays, but you can use them with any type of effect. (p.85)

## Master EQ

You can make master EQ settings in the MULTI 9: MasterFX page.

The master EQ is located immediately before the (MAIN OUTPUT) L/MONO and R outputs. Use it to adjust the overall tone. (p.85)

## Saving your edits

Once you’ve tweaked the sound to perfection, you’ll want to save your work. To save your edits:

1. Press the [UTILITY] button to access the utility menu.
2. Use the ClickPoint to select “Write Multi,” and then press the ClickPoint center.

The Write Multi dialog box will appear.



*Note:* If the display indicates “Memory Protected,” the multi set memory protect is turned on. Go to GLOBAL 0: System, Preference page, and uncheck the Memory Protect “Multi” setting. (p.88)

3. Optionally, you can also select a new location, or change the Multi set’s name or category.
  - If you want to change the name, use the ClickPoint to select the text button (T) and then press the ClickPoint center to open the text edit dialog box.

You can give the Multi set a descriptive name using the on-screen keyboard. (p.114)

After entering the name, press [MENU/OK] button.

The text edit window will disappear, returning you to the main Write dialog.

4. In the Write Multi dialog box, press the [MENU/OK] button to write (save) the program.
5. A message will ask you for confirmation. If you are sure you want to write the program, press the [MENU/OK] button once again.

The multi will be written (saved).

## Control via MIDI

Multi mode enables the microX to function as a MIDI tone generator that is controlled from the connected computer to play ensemble music consisting of multiple instrument parts. This mode also permits you to use the microX as a GM tone generator.

## Parameters and performance data

A multi set consists of tracks 1–16, parameters such as the multi set name, effect and arpeggiator parameters, and a tempo setting.

You can store 128 of these multi sets in the microX. Tracks 1–16 consist of the following “setting parameters,” and will transmit and receive the “performance data” listed below.

### MIDI tracks 1–16

#### Setup parameters

Bank/Program No.\*, Pan\*, Volume\*, Status, MIDI Channel, Bank Select (When Status=EX2), Force OSC Mode, OSC Select, Portamento\*, Transpose\*\*, Detune\*\*, Bend Range\*\*, OSC On/Off Ctrl, Delay, Use Program's Scale, MIDI Filter, Key Zone, Velocity Zone, Track Name, IFX/Indiv.Out BUS Select, Send1(MFX1)\*, Send2(MFX2)\*

#### Performance data

Note On/Off

Program Change (including Bank Select)

Pitch Bend

After Touch (Poly After)

Control Change

Exclusive Message

#### Tempo\*

\* You can record tempo as performance data by adjusting it while you realtime-record onto an

external MIDI sequencer. By receiving this data, you can change the setting of the multi set during the playback.

\*\* You can use performance data (MIDI RPN data) to change the settings of a multi set during playback.

Other parameters: By editing the settings during realtime recording, you can record the corresponding MIDI exclusive messages as performance data on your external MIDI sequencer. This gives you a way to change the settings of the multi set during playback. (GLOBAL 1: MIDI, MIDI Filter “Exclusive” must be checked.)

- For details on Control Change messages and RPN (PG p.172, 175).
- For details on MIDI System Exclusive messages (PG p.176).

### Default Settings in Multi Mode

The following table shows the default settings for Multi mode that are automatically selected, when GM Initialize is executed, or when the microX receives a GM ON messages (F0 7E 7F 09 01 F7).

	Parameter	Track1–9, 11–16	Track10	
0	Program Select	G001:Acoustic Piano	g001:(d):STANDARD Kit	
	Pan	C064	C064	
	Volume	100	100	
2	Status	–	–	The setting remains unchanged
	Use Program's Scale	–	–	The setting remains unchanged
7	Arpeggiator Assign	–	–	The setting remains unchanged
	Other Arpeggiator parameters	–	–	The setting remains unchanged
8	IFX/Indiv.Out BUS Select	L/R	DKit	
	Send1(MFX1)	0	0	
	Send2(MFX2)	40	40	
	IFX	–	–	The setting remains unchanged
	Pan(CC#8)	–	–	The setting remains unchanged
	BUS Select	–	–	The setting remains unchanged
	Send1	–	–	The setting remains unchanged
	Send2	–	–	The setting remains unchanged
	Other Insert Effect parameters	–	–	The setting remains unchanged
	9	MFX1	–	–
MFX2		–	–	53: Rev Smth. Hall
Return1		–	–	127
Return2		–	–	050
Other Master Effect and Master EQ parameters		–	–	Default settings

---

## Selecting a multi set

You can switch multi sets via MIDI by sending MIDI Song Select messages. A song select message will be transmitted when you switch multi sets. Conversely, you can switch multi sets by receiving a song select message from the source you specify. If the Global “Multi Mode” is set to “for Master,” switching the multi set number will cause each track with a “Status” of EXT, EX2 or BTH to transmit bank select, program change, volume, pan, portamento, send 1 and 2, post-IFX pan, and post-IFX send 1 and 2 messages on the channel specified for that track.

---

## Switching the program assigned to a track via MIDI

- Receiving MIDI program change messages to select programs: (PG p. 39 “Using MIDI program change messages to select programs”)

*Note:* In order to select programs via MIDI program changes, the track’s “Status” must be set to INT.

The MIDI channel of a track is specified by MULTI 2: Track Param, MIDI “MIDI Channel.” When a program change is received on a MIDI channel that matches the channel setting of a track, the program will change if the “Status” of that track is INT. However, program changes for a track will also depend on the “Program Change” setting. The “Status” setting is located in the MULTI 2: Track Param, MIDI page, and the “Program Change” setting is in the MULTI 3: MIDI Filter1, -1 page.

If you’ve installed the included “microX Plug-In Editor” control plug-in into your DAW software, you can conveniently select the microX programs from a list within your DAW. For more details, see “Editor/Plug-In Editor Manual” (PDF).

---

## MIDI control from the microX’s controllers

If the “Status” is INT or BTH, playing the keyboard or operating the controllers on the “Control Track” will play/control the microX’s tone generator with the settings (program, level, etc.) of the selected track, and any other track set to the same MIDI channel will also sound at this time. If the “Status” is EXT, EX2, or BTH, these messages will be transmitted on the MIDI channel specified for that track.

For more about the MIDI messages transmitted when you operate the microX’s controllers, and the AMS (Alternate Modulation Source) and DMS (Dynamic Modulation Source) that correspond to each MIDI message, see “MIDI transmission when the X50/microX’s controllers are operated” (PG p. 166).

---

## Other MIDI control

For details on how the microX operates when transmitting or received control change messages, see “MIDI transmission when the X50/microX’s controllers are operated” (PG p. 166). For more about MIDI in general, see “MIDI applications” (PG p. 171).



# Effects settings

The effect section of the microX provides one **insert effect**, two **master effects**, one **master EQ** (stereo 3-band EQ), and a **mixer** that controls the routing of these components.

## Effects in each mode

### Program mode

In **Program mode**, the **insert effect** can be used as part of the sound-creating process, in the same way that the output sound of the oscillator (OSC) is processed by the filter and amp to create the final sound. Then the **master effects** can be used to apply spatial-type effects such as reverb. The stereo 3-band **master EQ** located immediately before the (MAIN OUTPUT) L/MONO and R outputs is used to make final adjustments in tone. These settings can be made independently for each program.

#### PROG 8: Ed-InsertFX

- Select the BUS and master effect send level for the oscillator output.
- Insert Effect routing, selection and settings.

#### PROG 9: Ed-MasterFX

- Master Effect selection and settings.
- Master EQ settings.

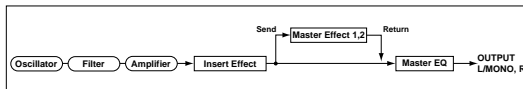

### Combination mode, Multi mode

In **Combination mode**, and **Multi mode**, the **insert effect** can be applied to each timbre/track. The **master effects** are used to apply overall spatial processing, and the **master EQ** is used to make overall adjustments in tone. These settings are made in Combination mode independently for each combination, and in Multi mode for each multi set the entire mode.

#### COMBI 8: Ed-InsertFX

- BUS and master effect send level settings for each timbre.
- Insert Effect routing, selection and settings.

#### COMBI 9: Ed-MasterFX

- Master Effect selection and settings.
- Master EQ settings.

#### MULTI 8: InsertFX

- BUS and master effect send level settings for each track.
- Insert Effect routing, selection and settings.

#### MULTI 9: MasterFX

- Master Effect selection and settings.
- Master EQ settings.

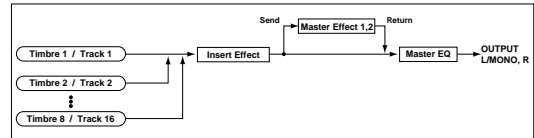

## Effect types

You can choose from 89 types of full-digital effects for each effect. The effects are categorized as follows.

### Categories of the 89 effect types

Effect No.	Effect types
01–15	Filter and dynamics effects, such as EQ and compressor
16–31	Pitch and phase modulation effects, such as chorus and phaser
32–40	Other modulation and pitch-shift effects such as rotary speaker and pitch shifter
41–51	Early reflection and delay effects
52–57	Reverb effects
58–89	Mono and mono-chain effects in which two mono effects are connected in series

Here we will describe some representative effects in each category.

### Filter and dynamics control effects

Equalizers (07: St.Para.4EQ–08: St.Graphic7EQ) divide the frequency range into several bands, and allow you to boost or cut the level of each band. Normally they are used to correct or compensate the sound, but they can also be used to simulate the frequency response that is typical of a particular instrument (such as the resonances of a guitar or string instrument).

Compressors (02: St.Compressor) compress the dynamic range of the input signal. Compression makes the sound punchier and more consistent. This is particularly effective on guitar, piano, or drum sounds.

Limiters (03: St.Limiter–04: Mltband Limit) limit the level of the input signal to a maximum level that you specify.

Exciters (11: St.Exct/Enhcr) give the sound greater clarity and definition. Enhancers sharpen the outline of the sound, bringing it to the front of the mix. By using these appropriately, you can bring out sounds that were unclear or easily lost in the mix.

Distortion (06: OD/HiGain Wah) distorts the sound. This simulates the distorted sound that is typically created on a guitar by making the amplifier distort the sound. It is often used not only on guitar sounds, but also on rock organ sounds.

### Pitch/phase modulation effects

Chorus effects (16: St.Chorus–19: St.Ensemble, 26: St.BiphaseMod) are an effective way to add spaciousness and thickness to any type of sound. These are ideally suited for use with electric pianos, strings, guitars, and so on. In an ensemble, pitch variations between instruments create a rich, slightly warbling sound. Essentially, this gives the impression that a number of musicians are playing together. The chorus effect simulates this. In stereo performance, the stereo image is widened, thus creating a magnificent spatial ambience.

Flanger effects (20: St.Flanger–22: St.Env.Flanger) add unique characteristics to a sound. Although similar to chorus, a flanger uses a shorter delay time and feeds some of the output signal back into the effect, creating a strong swell. Flangers work very well on sounds that contain a lot of harmonics, as well as on distorted guitar sounds.

Phasers (23: St.Phaser–25: St.Env.Phaser) cyclically modulate the phase of the sound. They are similar to the chorus and flanger effects in that both use modulation, but the manner in which the tonal quality changes is different. They are effective with electric piano, guitars, and synth sounds with a reasonable sustain.

### Other modulation and pitch shift effects

Rotary speaker effect (40: Rotary SP) simulates the rotating speaker effect used in organs. It is ideal for use with organ sounds, but it will also create a unique effect with other sounds.

Pitch shifters (38: Pitch Shifter, 39: PitchShift Mod) shift the pitch of the input signal. You can mix the pitch-shifted sound with the original sound to create a chorus effect, or create special effects in which the pitch continues to rise (or fall).

### Early reflection and delay effects

Early reflection effect (41: Early Reflect) produces only the early reflections of a reverb effect. Using just these early reflections, you can add weight or spatial effects to a sound, such as reverberation. Without the reverberation, you can achieve a clean effect sound.

Delays (43: LCR Delay–51: Sequence Dly) create an echo effect by delaying the sound for a fixed length of time. You can also make the delayed sound repeat (feed back).

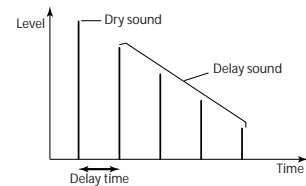

### Reverb effects

Reverb (52: Rev Hall–57: Rev Brt. Room) is an effect that creates the spacious reverberation of sounds played in a hall or room. Reverb simulates the sounds that are reflected from the ceiling and wall.

When you hear music in a concert hall, the sound from the instruments and voices reaches your ear directly, but also reaches your ear after being reflected off the ceiling and walls (and being delayed by a corresponding length of time). In this way, the direct sound (the “dry” sound) is joined by numerous reflections that create the impression of a large acoustical space. The way in which the sound is reflected will depend on the materials of the ceiling and walls, and also on the size and shape of the hall. These factors also affect the way in which the reverberation decays. Different effect types let you simulate a broad range of reverberation, and you can also edit the parameters to make detailed changes to the character of the sound.

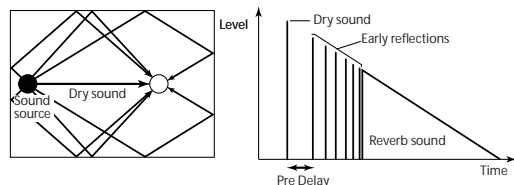

### Effects that combine two mono effects connected in series

These connect two mono effects in series. They include a four-band parametric equalizer connected in series with some other effect (e.g., exciter, chorus, delay), or a compressor connected with another effect (of the types listed above).

# Effect settings for a program

## Routing

The structure of the insert effect, master effects, and master EQ is the same in each mode. However, the routing will determine how the oscillator output of the program is sent to the insert effect and the master effects. As an example, here's how to specify the routing and make effect settings in Program mode.

1. Access the PROG 8: Ed-InsertFX, BUS page.
2. Set "BUS Select (All OSCs)" to specify where the oscillator output will be sent.

**L/R:** The output will be sent to (MAIN OUTPUT) L/MONO and R. (See diagram below)

*Note:* After passing through the master EQ, the sound will be sent to (MAIN OUTPUT) L/MONO and R.

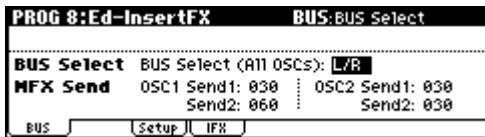

**IFX:** The output will be sent to insert effect IFX. (See diagram below)

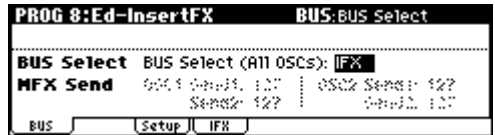

**1, 2, 1/2:** The output will be sent to (INDIVIDUAL OUTPUT) 1 or 2. (See diagram below)

*Note:* It will not be sent to the insert effect, the master effects, or the master EQ.

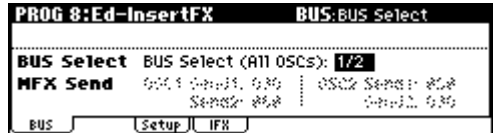

**Off:** The sound will not be sent to (MAIN OUTPUT) L/MONO, R, (INDIVIDUAL OUTPUT) 1 and 2. After passing through the master effects, the sound is sent to the MAIN OUTPUT. Choose this setting if you want to send the sound in series through the master effects at the send level specified by "MFX Send." (See diagram below)

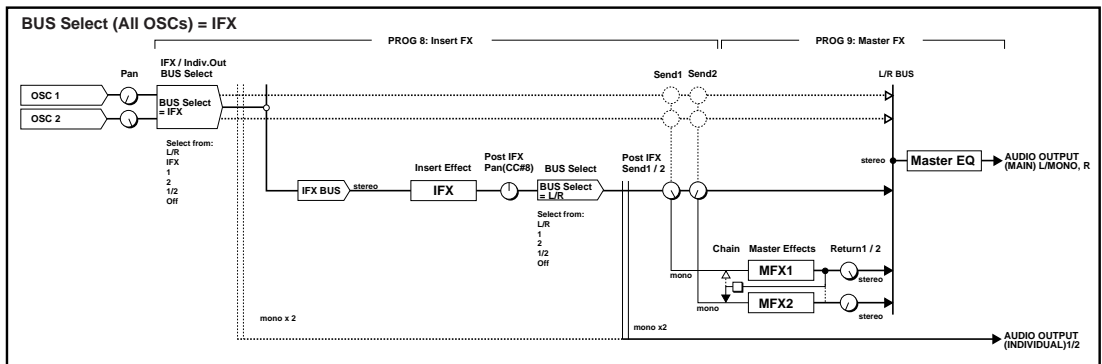
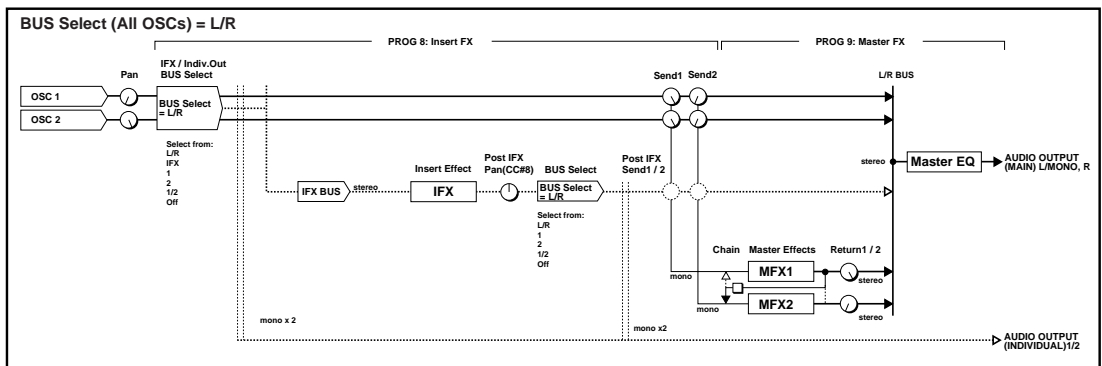
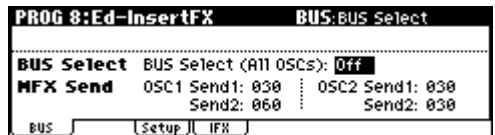

Effect

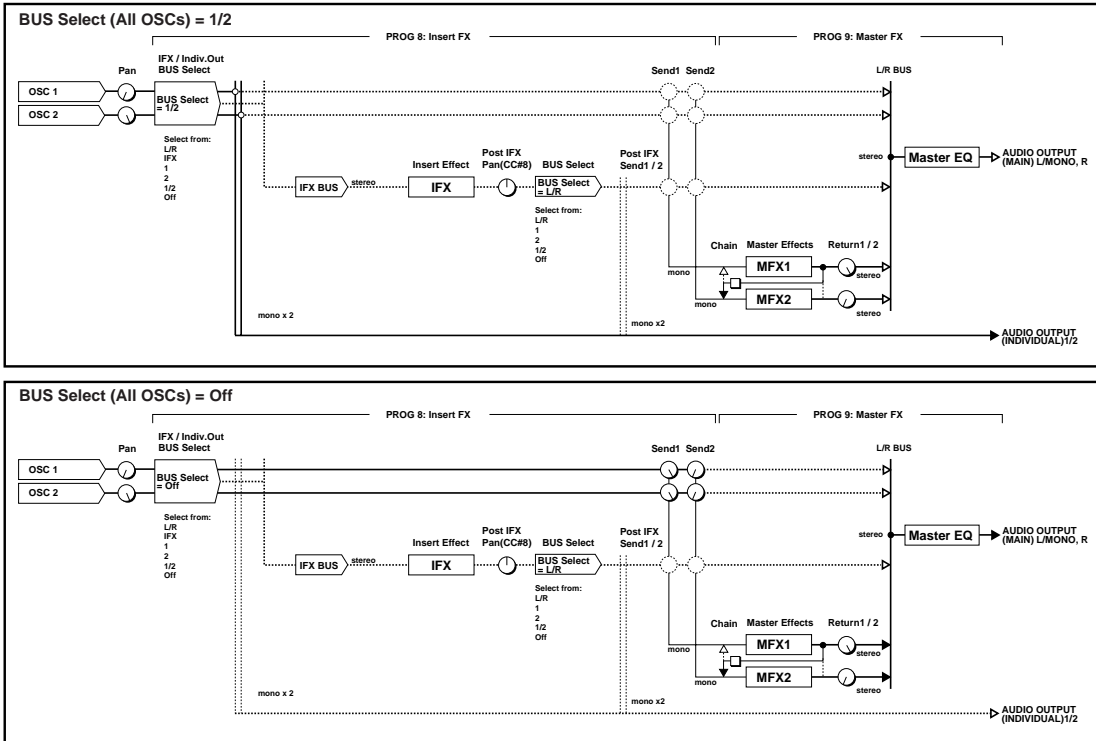

3. “MFX Send” specifies the send level from each oscillator to the master effects.

This is valid only if “BUS Select (All OSCs)” is set to **L/R** or **Off**.

If **IFX** is selected for “BUS Select (All OSCs),” the send level to the master effects is adjusted by the “Send 1 (MFX1)” and “Send 2 (MFX2)” parameters (PROG 8: Ed-InsertFX, Setup page) after the signal has passed through the insert effect.

2. In “Insert Effect,” select the desired insert effect.

You can press the [CATEGORY] button and choose an effect from six categories.

3. In “IFX On/Off,” turn the insert effect on/off.

If this is set to **Off**, the result will be the same as if **00: No Effect** is selected. The input sound will be output without change.

*Note:* You can use the Utility “Copy Insert Effect” to copy effect settings from another program, etc.

4. Set the “Pan (CC#8),” “BUS Select,” “S1 (Send1 (MFX1)),” and “S2 (Send2 (MFX2))” parameters that follow the insert effect.

“**Pan (CC#8)**”: Set the pan. This is valid only if “BUS Select” is set to **L/R**.

“**BUS Select**”: Specify the output destination. Normally you will set this to **L/R**. If you want to output the sound from (INDIVIDUAL OUTPUT) 1 and/or 2, set this to **1**, **2**, or **1/2**.

“**Send1 (MFX1)**,” “**Send2 (MFX2)**”: Set the send level to the master effects. For this example, set these to **127**.

## Selecting an insert effect, and routing after the insert effect

1. Access the PROG 8: Ed-InsertFX, Setup page.

The Setup page displays the state of the routing and the insert effect settings. In this page you can also make “BUS Select” settings. Use the ClickPoint to choose (All OSCs), and use the [VALUE] dial etc. to make a selection.

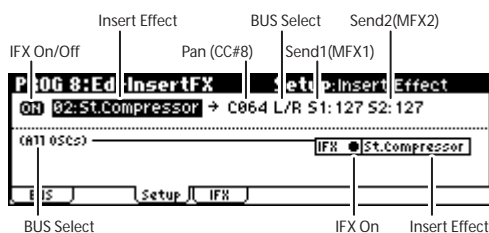



5. Move to the IFX page, and set the parameters of the effect that you selected for the insert effect.

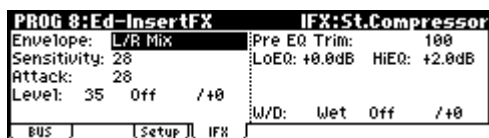

For details on the parameters of each effect, see PG p.104–.

## Selecting master effects, and chain settings

The input level of the master effect is determined by the send level 1 and 2 settings (routing step 3, or insert effect step 4). If send levels 1 and 2 are 0, no master effects will be applied. Send level 1 is for MFX1, and send level 2 is for MFX2.

1. Access the PROG 9: Ed–MasterFX, Setup page.

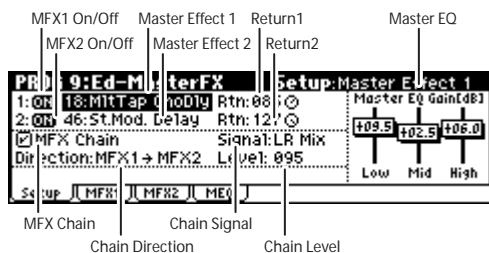

2. In “Master Effect 1” and “Master Effect 2,” select the type of each master effect.  
You can press the [CATEGORY] button and choose an effect from six categories.

*Note:* The input/output of the master effect is mono-in/stereo-out. Even if you select a stereo-input type effect, the input will be monaural.

3. In “MFX1 On/Off” and “MFX2 On/Off,” switch each master effect on/off.  
If this is **Off**, the output of the master effect will be muted.
4. In “Return 1” and “Return 2,” adjust the output level of each master effect.  
For each effect, the **W** value of “W/D” (Wet/Dry) is the effect output level. This is multiplied by the return value (“Rtn”=127 is x1.0) to determine the actual master effect output level.
5. Specify the routing of master effects 1 and 2.  
If the “MFX Chain” check box is checked, MFX1 and MFX2 will be connected in series. The settings described below are valid if this check box is checked.

“Chain Direction” specifies the direction in which MFX1 and MFX2 will be connected.

“Chain Signal” specifies whether the signal sent from one master effect to the other will be stereo, or only L or R.

“Chain Level” specifies the level at which the signal is sent from one master effect to the other master effect.

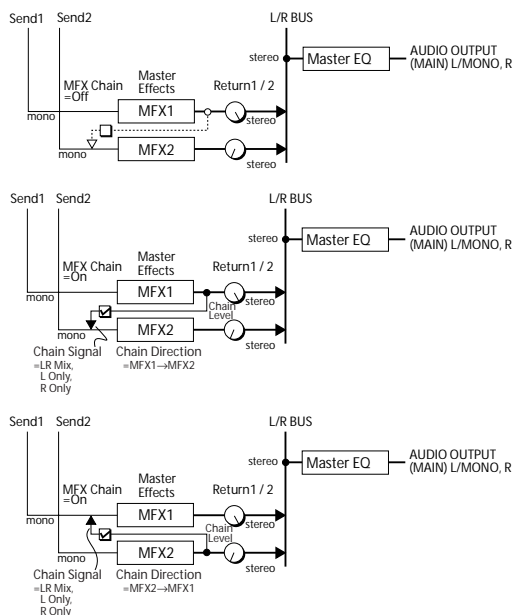

6. Move to the MFX1 or MFX2 page, and set the parameters of the effect that you selected as the master effect.

For details on the parameters of each effect, see PG p.104–.

## Master EQ

1. Use the stereo 3-band master EQ to make final equalizing adjustments immediately before the sound is output from the (MAIN OUTPUT) L/ MONO and R jacks.  
Set the Low, Mid, and High gain in the PROG 9: Ed–MasterFX, Setup page. Low and High are shelving-type, and Mid is a peaking-type adjustment. These settings are linked with the Low, Mid, and High “Gain” settings of the Master EQ page. In addition to these settings, the Master EQ page also lets you specify the center frequency and bandwidth (Mid only) of each band, and make settings for dynamic modulation.

# Effect settings in combination, and Multi

## Routing

In Combination and Multi modes, you can specify the routing of each timbre/track to the insert effect and master effects. These settings are made in the same way in each of these modes. We will be using the example of Combination mode in our explanation here.

1. Access the COMBI 8: Ed-InsertFX, BUS page.

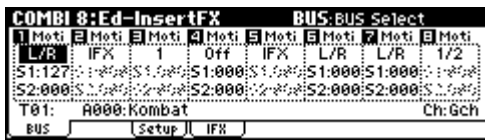

2. In "BUS Select," specify where the output of each timbre will be sent. (See diagram below)

**L/R:** The output will be sent to (MAIN OUTPUT) L/MONO and R.

*Note:* After passing through the master EQ, the sound will be sent to (MAIN OUTPUT) L/MONO and R.

**IFX:** The output will be sent to insert effect IFX.

**1, 2, 1/2:** The output will be sent to (INDIVIDUAL OUTPUT) 1 or 2.

*Note:* It will not be sent to the insert effect, the master effects, or the master EQ.

**Off:** The sound will not be sent to (MAIN OUTPUT) L/MONO, R, (INDIVIDUAL OUTPUT) 1 and 2. After passing through the master effects, the sound is sent to the MAIN

OUTPUT. Choose this setting if you want to send the sound in series through the master effects at the send level specified by "MFX Send." (See diagram below)

3. "S1" (Send1(MFX1)), "S2" (Send2(MFX2)) specifies the send level from each timbre to the master effects.

This can be set only if "BUS Select" is set to L/R or Off.

The actual send level will be the send level of each timbre multiplied by the send level of each oscillator of the program selected for the timbre. If the send level of a program is 0, the actual level will be zero even if the send level setting is raised here.

If IFX is selected for "BUS Select," set the send levels to the master effects by adjusting the "S1 (Send1(MFX1))" and "S2 (Send2(MFX2))" parameters (COMBI 8: Ed-InsertFX, Setup page) located after the signal has passed through the insert effect.

## Selecting an insert effect, and routing after the insert effect

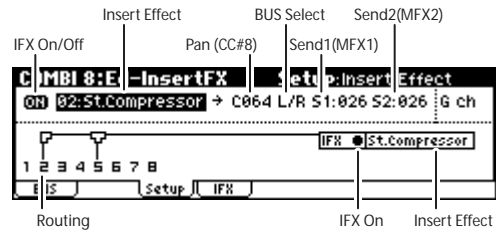

The Setup page displays the state of the routing and insert effect settings.

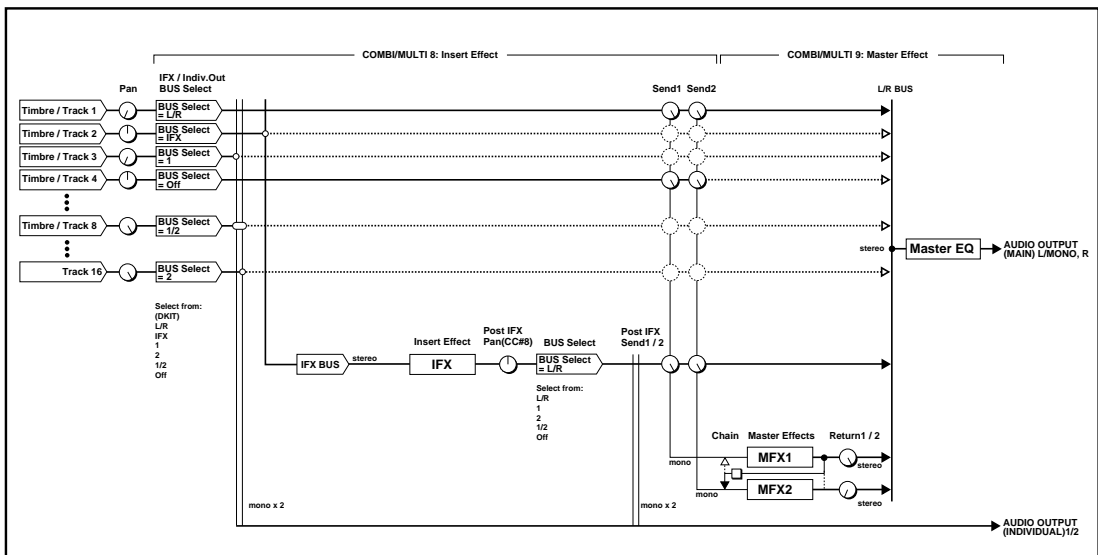

In this example, IFX is used by 2 (timbre 2) and 5 (timbre 5).

In the same way as for a program, you can select the insert effect, turn it on/off, and set the “Pan (CC#8),” “BUS Select,” “S1” (Send 1 (MFX1)), and “S2” (Send2 (MFX2)) parameters that follow the insert effect. (☞p.82)

## Master effects Master EQ

These settings are made in the same way as for programs (☞p.83).

## Specifying the MIDI channel that will control effects

### Insert effect

You can specify the MIDI channel that will control the insert effect dynamic modulation (Dmod) and the “Pan” (CC#8), “Send 1 (MFX1),” and “Send 2 (MFX2)” settings that follow the insert effect.

An asterisk “\*” is shown at the right of Ch01–16 for the channel numbers of timbres that are routed to IFX. If multiple timbres/tracks of different MIDI channels are routed to IFX, set the “Control Channel” to specify the channel you’ll use to control the effect.

For a combination, you will normally use the Gch (global MIDI channel) to control the effect.

For a multi set, you can use any MIDI channel that is convenient.

“All Rt.” stands for All Routed, indicating that you can control the effect using the channel of any timbre/track that is routed.

### Master effects

You can specify the MIDI channel that will control dynamic modulation (Dmod) for the master effects.

For a combination, you will normally use the Gch (global MIDI channel) to control the effects.

For a multi set, you can use any MIDI channel that is convenient.

## Dynamic modulation and BPM/MIDI Sync.

Dynamic modulation (Dmod) is a function that lets you use MIDI messages or the microX’s controllers to control specific effect parameters in realtime.

BPM/MIDI Sync. is another function that controls effect parameters, and is used to synchronize the LFO speed of modulation-type effects or the delay time etc. of delay-type effects to the tempo of the arpeggiator or an external sequencer.

## Using dynamic modulation to control effects in realtime

These examples show how you can use dynamic modulation to control an effect parameter in realtime.

- As described in the procedure for “Effect settings for a program” (☞p.81), set “IFX” to **49: LCR BPM Delay**. Verify that a delay sound is being output.

Then continue on to set the items described below.

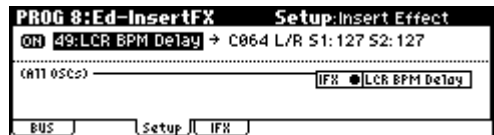

### Moving the joystick to vary the delay level via Dmod

- Access the PROG 8: Ed-InsertFX, IFX page.
- Set “InLvl Mod” to +100.
- Set “Src” to JS+Y#1.

The joystick will control the input level to the effect.

When you set “Src” to JS+Y#1, the level of delayed signal will be set to zero, and will gradually increase as you push up on the joystick.

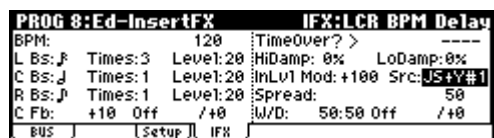

### Pressing a foot switch to vary the feedback level via Dmod

- In the GLOBAL 0: System, Foot page, set “Foot SW Assign” to Foot SW (CC#82).

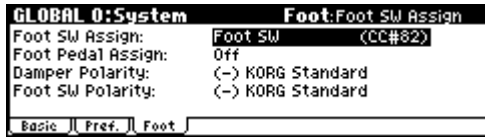

- Return to the PROG 8: Ed-InsertFX, IFX page, and set the C Fb (C Delay Feedback) “(Source)” to SW1 #82.
- Set “(Amount)” to +30.

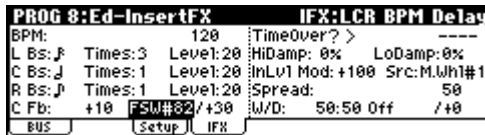

- (Move the joystick up.) Press the foot-switch; the feedback level will increase, and the delay sound will continue for an extended time.  
The “(Amount)” setting determines the feedback level when the foot-switch is pressed. If you set “(Amount)” to **-10** and press the foot-switch, the feedback level will be **0**.

### Using the BPM/MIDI Sync. function to synchronize the delay time to arpeggiator tempo changes.

The BPM/MIDI Sync. function lets you synchronize the delay time to the tempo of the arpeggio.

- In the PROG 8: Ed-InsertFX, IFX page, set “BPM” to MIDI.
- For L, C, and R, set “L/C/R Bs” and “Times” as desired.

For this example, set “L/C/R Bs” to  $\text{♪}$  and “Times” to **1** so that the effect will be easily understandable. The delay time will repeat at an interval of a 8th note.



- Set the realtime controller function to C-mode, and rotate REALTIME CONTROLS knob [4] (“TEMPO”).

(Move the joystick up.) Operate the knob; the delay time will change.

- Turn on the [ARP ON/OFF] button to start the arpeggiator.

Select an arpeggio pattern as desired.

(Move the joystick up.) When you rotate REALTIME CONTROLS knob [4], the delay

time will change in synchronization to any changes you make in the arpeggiator tempo.

- If you rotate the REALTIME CONTROLS knob [4] to change the tempo while the delay is sounding, noise may occur in the delay sound. This is because the delay sound becomes discontinuous, and is not a malfunction.

**MIDI** For some effects, you can synchronize the LFO frequency to the tempo. Set the effect parameters “BPM/MIDI Sync” to **On**, and “BPM” to **MIDI**. For details see PG p.160.

### Saving edited effect settings

Effect parameters that you edit in Program mode are saved when you write the program. Similarly, effect parameters that you edit in Combination mode or Multi mode are saved when you write the combination or multi set. (p.45, 61, 75)

### Bypassing the insert effect or the master effects

Normally, you will switch the effects on/off individually for each program, combination, or multi set. However, you also have the option of bypassing the insert effect or master effects for the entire microX if you don’t want to use them.

For example, this can be useful when you’re using an outboard effect such as reverb, chorus, or compressor to create an effect that you would otherwise create using the microX’s master effects, or when you’re using a plug-in effect on your computer to process the sound of the microX together with other sound sources.

- Press the [GLOBAL] button to enter Global mode.
- Access the GLOBAL 0: System, Basic page.

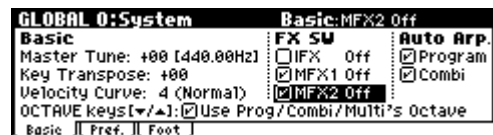

- Check the “IFX Off” check box if you want to bypass the insert effect.  
Check the “MFX1 Off” dialog box if you want to bypass master effect 1, or the “MFX2 Off” dialog box if you want to bypass master effect 2.

# Global Mode

## How Global mode is structured

In Global mode you can make overall settings that apply to the entire microX, such as master tuning, key transpose, effect global switch, global MIDI channel, and system clock.

In addition, you can create user drum kits, arpeggiator, and scales, make settings for the damper pedal and assignable foot switches/pedals, and specify category names for programs and combinations.

### Global mode page structure

0: System	<ul style="list-style-type: none"><li>• Basic settings for the entire microX</li><li>• Controller settings for the pedals etc. connected to the rear panel</li></ul>
1: MIDI	<ul style="list-style-type: none"><li>• MIDI-related settings for the entire microX</li></ul>
2: User Scale	<ul style="list-style-type: none"><li>• User registered scale settings. Specify 16 octave scales, and one all-note scale.</li></ul>
3: Category Name	<ul style="list-style-type: none"><li>• Edit category names for programs and combinations</li></ul>
4: DKit	<ul style="list-style-type: none"><li>• Edit drum kits</li></ul>
5: Arp.Pattern	<ul style="list-style-type: none"><li>• Edit user arpeggio patterns.</li></ul>
6: Ext Control	<ul style="list-style-type: none"><li>• External control settings. Assign CC# to REALTIME CONTROLS knobs</li></ul>

For details on how to access each page, tab or utility command, and how to edit the values, see “Basic operations” (p.19).

 The edits you perform in Global mode will be preserved until you turn off the power is turned off, but will be lost when the power is turned off. Four types of data are handled in Global mode: user drumkit settings (GLOBAL 4), arpeggiator settings (GLOBAL 5), external control settings (GLOBAL 6), and all other global settings (GLOBAL 0–3). You into its own memory area.

 Note that **Compare** can't be used in Global mode.

## System setup 0: System

### Basic Page

GLOBAL 0: System		Basic: MasterTune(Cent)	
Basic	FX SW	IFX Off	Auto Arrp.
Master Tune: +00 [440.00Hz]	<input type="checkbox"/> IFX Off	<input type="checkbox"/> MFX1 Off	<input checked="" type="checkbox"/> Program
Key Transpose: +00	<input type="checkbox"/> MFX2 Off	<input checked="" type="checkbox"/> MFX2 Off	<input checked="" type="checkbox"/> Combi
Velocity Curve: 4 (Normal)	OCTAVE keys[▼/▲]: <input checked="" type="checkbox"/> Use Prog/Combi/Multi's Octave		
Basic   Pref.   Foot			

### Tuning to another instrument/Transposing

“Master Tune” adjusts the overall pitch. Edit this setting when you are playing the microX with other instruments, or when playing along with music on CD or tape. You can adjust the pitch in a range of  $\pm 50$  cents (one semitone = 100 cents). If this is at 0, middle A is tuned to 440 Hz.

“Key Transpose” shifts the pitch in semitone steps. Edit this setting when you want to transpose the sound of the entire microX. You can adjust the transposition in a range of  $\pm 1$  octave.

### Adjusting the way in which velocity will affect the volume or tone

You can adjust the way in which changes in velocity will affect the volume or tone by selecting different velocity curves. Each curve has its own character, so you can select the curve that is appropriate for your own playing dynamics, playing style, and the effect that you wish to obtain. (PG p.76)

“Velocity Curve” selects the velocity curve.

### Bypassing the effects

If the FX SW “IFX Off,” “MFX1 Off,” and “MFX2 Off” boxes are checked, the insert effect, master effect 1, and master effect 2 will respectively be bypassed. This applies to the entire microX regardless of the mode. For example, if you've connected the microX's outputs to an external mixer and are using an external effect processor to apply reverb or chorus to the sound, you can turn off the microX's master effects.

## Linking the arpeggiator to programs and combinations

You can specify whether the arpeggiator settings written to a program or combination will also be selected when you select that program or combination, or whether the arpeggiator settings will remain in their current state when you switch the program or combination.

When the microX is shipped from the factory, the former setting is selected. You can use the latter setting if you want to use the same arpeggiator settings to generate phrases and patterns while you select and try out different programs and combinations.

If the Auto Arp. “Program” or “Combination” boxes are checked, selecting a program or combination respectively will also select the arpeggiator settings that are written in that program or combination.

## OCTAVE

When you switch programs, combinations, or multi sets, you have the option of also recalling the OCTAVE [▼][▲] button setting that is written as part of this data.

If the “OCTAVE Keys [▼/▲]: Use Prog/Combi/Multi’s Octave” box is checked, the OCTAVE [▼][▲] button setting written in the data will be recalled when you select the program etc. If this box is not checked, the OCTAVE [▼][▲] setting will not change when you select the program etc.; the current setting will be maintained until you switch the octave yourself.

## Preference Page

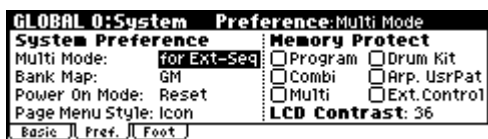

## Recalling the last-selected mode and page at power-on

The state of microX when the power is turned on will depend on the setting of “Power On Mode”.

If “Power On Mode” is set to Reset (factory setting), microX will automatically select the Combination mode 0: Play.

If “Power On Mode” is set to Memorize, microX will power on using the same mode and page that were selected when the power was previously turned off.

## Protecting the memory

If one or more of the “Memory Protect” boxes are checked, operations such as writing, loading etc. will be prohibited for the corresponding type of memory.

If you want to edit and write (save) settings, you’ll need to uncheck this box. In order to load the pre-loaded data, you’ll first need to uncheck the Memory Protect box for the data you want to load.

## Foot Page

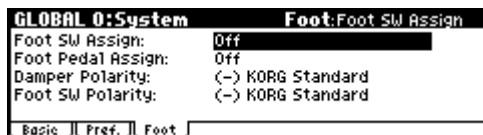

## Specifying the function of the ASSIGNABLE Switch and ASSIGNABLE Pedal

### Assignable Switch

**Foot SW Assign** lets you assign a function to a footswitch, such as the optional Korg PS-1, connected to the rear-panel ASSIGNABLE SWITCH jack.

- This is set by “Foot SW Assign.”

You can choose from the following functions:

- Alternate modulation source
  - Effect dynamic modulation source
  - Switch portamento on/off
  - Control the sostenuto effect
  - Turn the soft pedal effect on/off
  - Arpeggiator on/off
  - Select programs or combinations (up/down)
  - Tap tempo
  - Aftertouch transmission
- The functions of controllers such as the joystick or knobs [1]–[4]. (PG p.164)

## Assignable Pedal

You can specify the function of an assignable pedal, such as the optional VXP-10 EXP/VEL pedal or EXP-2 foot controller, connected to the ASSIGNABLE PEDAL jack.

- This is set by “Foot Pedal Assign.”  
 You can choose from the following functions:  
 Master volume  
 Alternate modulation source  
 Effect dynamic modulation source  
 Portamento pitch change speed  
 Volume  
 The pan following an insert effect  
 Pan  
 Expression  
 Send levels to the master effects  
 Aftertouch transmission  
 Duplicate the function of another controller, such as the joystick or knobs [1]–[4] (≡PG p.165)

*Note:* You can use this as a source for alternate modulation or effect dynamic modulation, and use it to control program parameters or effect parameters. In this case, set “Foot SW Assign” to Foot SW (CC#82), and “Foot Pedal Assign” to Foot Pedal (CC#04).

## MIDI-related settings 1: MIDI

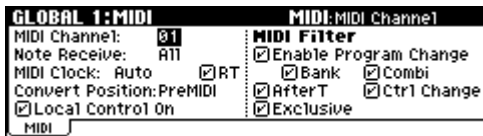

## MIDI Setup, MIDI Filter

Here you can make MIDI-related settings for the entire microX, such as the global MIDI channel and the MIDI clock setting. You can also use the utility commands of this page to transmit MIDI System Exclusive data dumps. (≡PG p.81)

## Creating user scales 2: User Scale

### Creating an original scale, and assigning it to a Program

On the User Scale page, you can create your own original scales. These include sixteen different User Octave Scales, in which the pitch of each note of the octave is repeated for all octaves, and one User All Note Scale, in which the pitch of each of the 128 notes can be specified independently.

By adjusting the pitch of each key in the range of ±99 cents, you can raise or lower it by approximately one semitone relative to the normal pitch.

The user scales you create here can be used by specifying the scale for a program, for each timbre of a combination, or for each track of a Multi set.

You can choose these scales from the following pages.

Mode	Page
Program	1: Ed–Basic, Program Basic
Combination	2: Ed–TimbreParam, Other
Multi	2: Track Param, Other

Here’s how to set the scale type for each track in Multi mode.

1. Create a user octave scale or a user all notes scale.

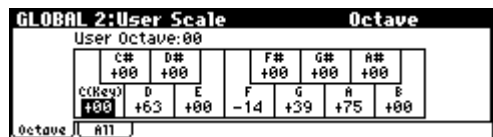

Select a key, and use the VALUE controllers to adjust the pitch. The range of ±99 raises or lowers the pitch approximately one semitone above or below the standard pitch.

*Note:* You can copy one of the preset scales and edit it to create an original scale. To do so, use the “Copy Scale” utility.

2. Press the [MULTI] button to enter Multi mode.
3. Press the [MENU/OK] button, choose “Track Param” from the “PAGE MENU,” and then press the [PAGE+] button to access the 2: Track Param, Other page.



4. If you want the Track to use the scale saved with its individual Program, check the track's "Use Prog's Scale" check box.  
Tracks that are not checked will use the scale specified by Scale "Type" (Multi's Scale).
5. Set "Type" (Multi's Scale) to select the scale for the currently selected song.

---

## Setting category names

### 3: Category Name

---

#### Program, Combination Category

The Category Name pages let you assign names to the Program, and Combination categories. (PG p.86)

---

## Saving the global settings

When you've finished editing in the Global mode, you'll need to write (save) your settings.

 The edits you perform will be lost when the power is turned off, unless you save them.

1. Select one of the GLOBAL 0: System-3: Category Name pages.
2. Press the [UTILITY] button to access the utility menu, and choose "Write Global Setting."
3. To write (save) your settings, press the [MENU/OK] button.

A dialog box will ask you to confirm that you want to write the settings.

4. Press the [MENU/OK] button to write your settings, or press the [EXIT/CANCEL] button if you decide not to write.

The global settings will be written (saved).

---

## Drum kit 4: DKit, Arpeggiator 5: Arp.Pattern, External Control 6: Ext.Control settings

Here you can make drum kit, arpeggiator, and external control settings.

See the corresponding page listed below.

 p.107 "Using Drum Kits"

 p.91 "Arpeggiator settings"

 p.111 "External control settings"



# Arpeggiator settings

The **arpeggiator** is a function that automatically generates arpeggios (playing the notes of the chord individually, with a constant tempo). Most arpeggiators produce an arpeggio when you play a chord on the keyboard.



The chord you play on the keyboard is sounded as an arpeggio (individual notes)

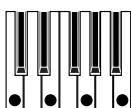

In addition to this, the microX's arpeggiator is a polyphonic arpeggiator that is able to produce a variety of chordal transformations or phrases based on the pitch or timing of the notes you play on the keyboard. These functions let you use the arpeggiator to play a wide range of patterns including drum or bass phrases, and guitar or keyboard backing riffs. It is also effective to use the arpeggiator as part of the sound-creating process when creating subtly-moving pads, synth-sounds, or sound effects.

In Program mode you can use one arpeggiator. In Combination mode and Multi mode, the microX features a Dual Polyphonic Arpeggiator that lets you simultaneously use two arpeggio patterns. You can take advantage of this in many ways, such as applying separate arpeggio patterns to a drum program and a bass program, or using keyboard zones or velocity splits to switch between two arpeggio patterns.

UP, DOWN, ALT1, ALT2, RANDOM	Preset arpeggio patterns
U000–250	With the factory settings, this contains a variety of preloaded user arpeggio patterns. You can create and write your own user arpeggio patterns.

## Arpeggiator features in Program mode

### Using the arpeggiator in Program mode

1. Press one of the PROGRAM [A]–[GM] buttons. (The button will light.)

Program mode is selected. (☞ p.37 “Selecting programs”)

As you select various programs, you will notice that the [ARP ON/OFF] button will light for some programs. Play the keyboard of the microX and the arpeggio will start.

For other programs, you can press the [ARP ON/OFF] button (the button will light) to turn on the arpeggiator. Arpeggios will begin sounding when you play the keyboard.

2. As described in the following sections “Arpeggio controllers” and “Editing arpeggio settings that appear in the display” (☞ p.92), move the controllers or modify the parameters to change the way in which the arpeggios are played.

### Arpeggio controllers

#### Arpeggiator on/off (ARP ON/OFF)

- Each time you press the [ARP ON/OFF] button, the arpeggiator will be switched on/off.

When this is on, the button will light, and playing the keyboard will start the selected arpeggio pattern.

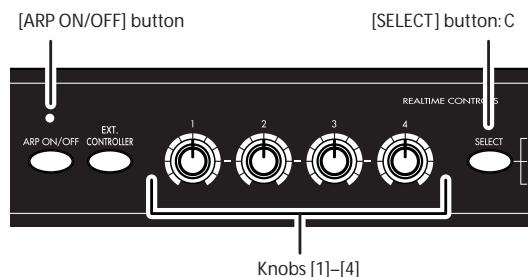

### Adjusting the arpeggiator tempo (TEMPO)

1. Press the REALTIME CONTROLS [SELECT] button to make the right “C” LED light.
2. Rotate the [4] (TEMPO) knob to adjust the tempo. The “♩=” value in the upper right of the display will change.

You can set this in the range of **40–240**. The LED located above the [ARP ON/OFF] button blinks at quarter-note intervals of the timing you specify.

You can also set the timing from within the display. Use the ClickPoint to select “♩=” and turn the [VALUE] dial to specify the tempo. The LED will blink at the specified tempo.

*Note:* You can set the tempo by pressing a separately sold PS-1 foot switch that is connected to the PEDAL jack (when “Foot SW Assign” is set to Tap Tempo).

*Note:* The arpeggio playback speed is affected by the “Reso (Resolution)” setting (0: Play, Arp. Play page, 7: Ed-Arp/Ctrls, Setup page).

**MIDI** If “MIDI Clock” (GLOBAL 1: MIDI) is set to Ext-MIDI or Ext-USB, or set to Auto and MIDI clock messages are being received from an external device, the display will indicate “♩=” EXT. This lets you synchronize the tempo with an external MIDI device. In this case you won’t be able to adjust the tempo on the microX.

### Adjusting the length of the arpeggiated notes (ARP-GATE)

1. Press the REALTIME CONTROLS [SELECT] button to make the right “C” LED light.
2. Rotate the [1] (ARP-GATE) knob to adjust the duration of the arpeggiated notes.

Rotating the knob toward the left will shorten the notes, and rotating it toward the right will lengthen the notes. At the center position (12 o’clock), the note length will be as specified by the program parameter “Gate” (7: Ed-Arp/Ctrls, Setup page).

*Note:* You can control the effect by simultaneously adjusting the REALTIME CONTROLS A-mode [4] (EG-RELEASE) knob.

### Adjusting the level of the arpeggiated notes (ARP-VELOCITY)

1. Press the REALTIME CONTROLS [SELECT] button to make the right “C” LED light.
2. Rotate the [2] (ARP-VELOCITY) knob to adjust the strength (or level) of the arpeggiated notes.

Rotating the knob toward the left will make the notes weaker, and rotating the knob toward the right will make the notes stronger. At the center position (12 o’clock), the velocity will be as specified by the program parameter “Velocity” (7: Ed-Arp/Ctrls, Setup page).

*Note:* You can control the tone effectively by simultaneously adjusting the REALTIME CONTROLS A-mode [1] (LPF CUTOFF), [2] (RESONANCE/HPF), and [3] (EG-INTENSITY) knobs.

### Changing the length of the arpeggio pattern (ARP-LENGTH)

1. Press the REALTIME CONTROLS [SELECT] button to make the right “C” LED light.
2. Turn the [3] (ARP-LENGTH) knob to change the length of the arpeggio pattern.

At the center position (12 o’clock), the length will be the same as the arpeggiator’s “Lgth (Length)” setting (7: Ed-Arp/Ctrls, Setup page). Turn the knob toward the left to shorten the pattern, or toward the right to lengthen the pattern. The arpeggio pattern will play repeatedly for the number of times specified by LENGTH. Changing this value will change the character of the pattern.

*Note:* This has no effect for the preset patterns (UP, DOWN, ALT1, ALT2, RANDOM).

### Saving your settings

The [ARP ON/OFF] button on/off status together with the REALTIME CONTROLS knob and key settings are saved when you write the program, combination, or multi-set.

### Editing arpeggio settings that appear in the display

You can make arpeggiator-related settings in the PROG 0: Play, Arp. Play page or in the PROG 7: Ed-Arp/Ctrls, Setup and Zone pages. The 0: Play, Arp. Play page contains selected parameters (taken from the 7: Ed-Arp/Ctrls, Setup page) that are particularly effective for editing during a performance. However, parameters other than “Swing” can be controlled as described in “Arpeggiator controllers” (p.91).



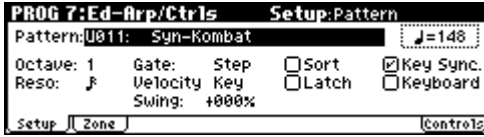

### Editing in the PROG 0: Play, Arp. Play page

- Access the PROG 0: Play, Arp. Play page.

### Selecting an arpeggio pattern (Pattern)

An arpeggio pattern can be selected from preset arpeggio patterns **Preset-0–Preset-4** and user arpeggio patterns **U000–250**. With the factory settings, **U000–250** contain a wide variety of preload user arpeggio patterns.

- Use the ClickPoint to select “Pattern,” and use the [VALUE] dial to select an arpeggio pattern.

The way in which the pattern is played will depend on settings such as “Octave” and “Sort.” **Preset-0–Preset-4** in the following diagrams show how the arpeggio will be played when “Octave” is set to 1, and “Sort” is checked. **Preset-4: RANDOM** is one possibility.

#### Preset-0: UP

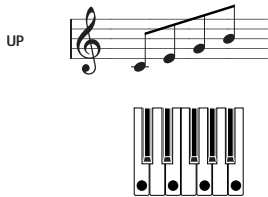

#### Preset-1: DOWN

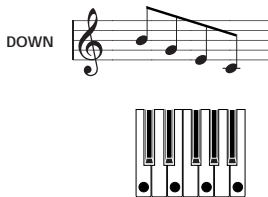

#### Preset-2: ALT1

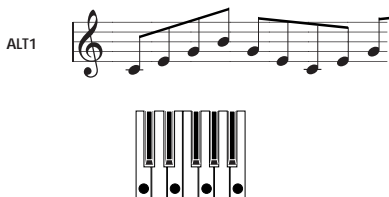

#### Preset-3: ALT2

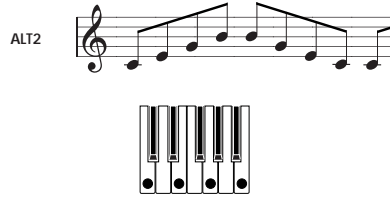

#### Preset-4: RANDOM

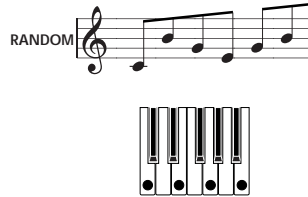

#### U000–U250

With the factory settings, various arpeggio patterns are preloaded. These include a variety of patterns such as drum or bass phrases, or guitar or keyboard backing riffs.

### Changing the timing value of the arpeggiated notes (Resolution)

Use “Reso (Resolution)” to specify the spacing between the arpeggiated notes in a range of ♩–♩.

- Use the ClickPoint to select “Reso,” and then use the [VALUE] dial to specify the spacing between the arpeggiated notes.

### Selecting the octave range of the arpeggiated notes (Octave)

Use “Octave” to specify the octave range in which the arpeggio is produced.

- Use the ClickPoint to select “Octave,” and use the [VALUE] dial to specify the octave range in which the arpeggio is produced.

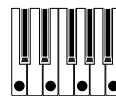
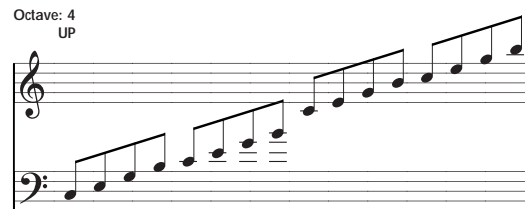

*Note:* If a user arpeggio pattern is selected, the “Octave Motion” setting (GLOBAL 5: Arp.Pattern, Setup page) will affect the way in which the arpeggio is played.

### Selecting the playback order of the arpeggiated notes (Sort)

“Sort” is different than selecting the arpeggiator pattern. “Sort” specifies whether the notes of the arpeggio will be sounded in order of their pitch (regardless of the order in which they were played) or in the order in which you played them.

- Use the ClickPoint to select the “Sort” check box, and press the center.

**Checked:** the arpeggio will sound each note in the order of its pitch, regardless of the order in which you actually played the notes.

**Unchecked:** the arpeggio will sound each note in the order in which you actually played the notes.

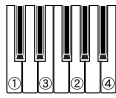
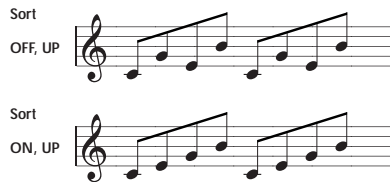

### Letting the arpeggio continue playing even after you take your hand off the keyboard (Latch)

“Latch” specifies whether the arpeggio will continue playing even after you take your hand off the keyboard, or stop playing when you take your hand off the keyboard.

- Use the ClickPoint to select the “Latch” check box, and press the center.

**Checked:** The arpeggio will continue playing even after you remove your hand from the keyboard.

**Unchecked:** The arpeggio will stop playing when you remove your hand from the keyboard.

### Synchronizing the arpeggiator to your keyboard timing or to the tempo (Key Sync.)

“Key Sync.” specifies whether the arpeggio pattern will begin the moment you play the keyboard, or always follow the tempo in synchronization with the MIDI clock.

- Use the ClickPoint to select the “Key Sync.” check box, and press the center.

**Checked:** When you take your hands completely off of the keyboard, the arpeggio pattern will immediately start over from the beginning in sync with the first key you press. This setting is suitable when you want the arpeggio to start from the beginning of the measure as you are playing in realtime.

**Unchecked:** The arpeggio will always be synchronized to the MIDI clock tempo.

### Selecting whether to hear the arpeggiated notes, the notes you physically play on the keyboard, or both. (Keyboard)

- Use the ClickPoint to select the “Keyboard” check box, and press the center.

**Checked:** The notes you play on the keyboard and the notes played by the arpeggiator will both sound.

**Unchecked:** Only the arpeggiated notes will sound.

### Editing in the PROG 7: Ed-Arp/Ctrls, Setup page

See the preceding section for details on parameters that can also be set from the PROG 0: Play, Arp. Play page. Here we will explain the remaining parameters.

- Access the PROG 7: Ed-Arp/Ctrls, Setup page.

### Setting the duration of the arpeggiated notes (Gate)

“Gate” lets you specify the duration (gate time) of the arpeggiated notes. If a user arpeggio pattern is selected, you can set this to **Step**. In this case, the value of the “Gt” setting for each step (GLOBAL 5: Arp.Pattern, Edit page) will be used.

*Note:* This value will be in effect when the REALTIME CONTROLS C-mode [1] (ARP-GATE) knob is in the center position (12 o’clock). Be sure that the knob is in the center position when you make this setting.

### Setting the velocity of the arpeggiated notes (Velocity)

“Velocity” lets you specify the velocity of the arpeggiated notes. If this is set to **Key**, the velocity with which you actually played the note will be used. If a user arpeggio pattern is selected, you can set this to **Step**. In this case, the value of the “Vel(Velocity)” setting for each step (GLOBAL 5: Arp.Pattern, Edit page) will be used.

*Note:* This value will be in effect when the REALTIME CONTROLS C-mode [ARP-VELOCITY] knob is in the center position (12 o'clock). Be sure that the knob is in the center position when you make this setting.

*Note:* When a preload user arpeggio pattern is selected, setting the “Gate” or “Velocity” to **Step** will add a sense of groove to the arpeggio pattern.

### Making the arpeggio pattern “shuffle” (Swing)

“Swing” modifies the timing of the even-numbered arpeggiated notes, letting you give a “shuffle” character to the pattern.

### Editing in the PROG 7: Ed-Arp/Ctrls, Scan-Zone page

- Access the PROG 7: Ed-Arp/Ctrls, ScanZone page.

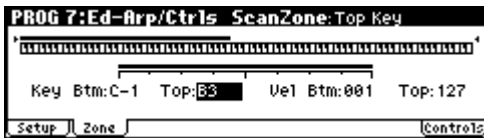

### Specifying the range of notes in which the arpeggiator will operate (Key Btm, Key Top)

“**Key Btm**,” “**Key Top**”: The arpeggiator will operate when you play keys within the specified range. Keys outside of this range can be played in the normal manner, and will not be affected by the arpeggiator on/off.

For example if you set “Pattern” to **Preset-0: UP**, check “Latch,” set “Key Top” to **B3**, and “Key Btm” to **C-1**, playing a note **B3** or lower will trigger the arpeggiator. Since “Latch” is **on**, the arpeggio will continue even after you release the keys. You can use the C4 and higher keys to play conventionally along with the arpeggio sounded by the B3 and lower keys. To change the arpeggio, play keys in the range of B3 and below.

### Specifying the range of velocities in which the arpeggiator will operate (Vel Btm, Vel Top)

“**Vel Btm**,” “**Vel Top**”: The arpeggiator will operate when you play notes with a velocity (playing strength) that is within the specified range. Notes played with a velocity outside this range will be sounded normally, without regard to the arpeggiator on/off.

### Writing (saving) the arpeggiator settings

Arpeggio parameters you edit in Program mode are saved along with the data when you write the program. For details on how to write, see “Saving your edits” (p.45).

### Linking the arpeggiator to a program

You can specify whether the arpeggio settings written in a program will also be selected when you switch to that program, or whether the existing state of the arpeggiator will be maintained. With the factory settings, the former setting is selected. If you want to use the latter setting, check Program in “Auto Arp” (GLOBAL 0: System, Basic page).

## The arpeggiator in Combination and Multi modes

In Combination and Multi mode, the microX provides **dual polyphonic arpeggiator** functionality that lets you use two arpeggio patterns simultaneously. The settings in each of these modes are made in the similar way.

As an example, the following explanation shows how to make settings in Combination mode.

### Using the arpeggiators as you play in Combination mode

1. Press a COMBINATION [A]-[C] button. (The button will light.)

You will enter Combination mode. (p.57 “Selecting combinations”)

As you select various combinations, you will notice that the [ARP ON/OFF] button will light for some combinations. When you play a key on the keyboard, the arpeggiator will start.

For other combinations, you can press the [ARP ON/OFF] button (the button will light) to turn on the arpeggiator.

-  In Combination and Multi set, depending on the arpeggiator A, B settings, the arpeggio may not start when you press the [ARP ON/OFF] button to turn it on. (p.96 “Select the arpeggiator(s) that will run”)
2. As described in “Arpeggio controllers” (p.91) and in “Editing arpeggio settings that appear in the display” (below), operate the controllers or edit the parameters to hear how the arpeggio changes.

*Note:* The [ARP ON/OFF] button and the REALTIME CONTROLS C-mode [1] (ARP-GATE), [2] (ARP-VELOCITY), [3] (ARP-LENGTH), and [4] (TEMPO) knobs are valid for both arpeggiators A and B. Their state will be memorized when the combination is written.

### Editing arpeggio settings that appear in the display

You can make arpeggiator-related settings in the COMBI 0: Play, Arp. Play A and B pages or in the COMBI 7: Ed-Arp/Ctrls page. The 0: Play, Arp. Play A and B pages contain selected parameters (taken from the 7: Ed-Arp/Ctrls, Arp. A and B pages) that are particularly effective for editing during a performance. However, parameters other than “Swing” can be controlled as described in “Arpeggio controllers” (p.91).

With the following exceptions, the display settings in the 0: Play, Arp. Play A and B pages are essentially the same as for a program.

1. Access the COMBI 0: Play, Arp. Play A page, and make settings for arpeggiator A.
2. Access the COMBI 0: Play, Arp. Play B page, and make settings for arpeggiator B.

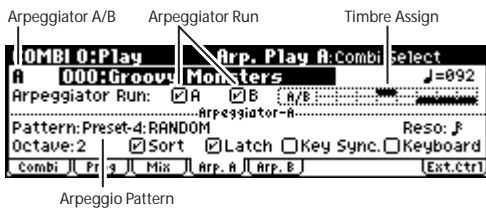

### Select the arpeggiator(s) that will run

Use the “Arpeggiator Run” check boxes to specify the arpeggiator(s) that you want to run. The arpeggiator(s) that are checked here will operate when the [ARP ON/OFF] button is on.

However, the arpeggiator will play a timbre only if the table displayed beside the check boxes assigns arpeggiator A or B to a Timbre 1–8. These settings are made in COMBI 7: Ed-Arp/Ctrls, Setup page “Assign” (p.96).

### Arpeggiator-A, Arpeggiator-B

For each arpeggiator A and B, you can make settings for “Pattern,” “Reso (Resolution),” “Octave,” “Sort,” “Latch,” “Key Sync,” and “Keyboard.” (p.92)

### Checking the structure of a user arpeggio pattern

Let’s see how arpeggiators of the combination is constructed.

1. Select combination C053: Echo Jamm, and look at the Arp. Play A page and Arp. Play B page.



- As you can see from the “Timbre Assign” table in the upper right, arpeggiator A is assigned to timbre 4 and 8, and arpeggiator B is assigned to timbre 2. When you play the keyboard, the **Dr-BigBeats 2** arpeggio pattern will play the program **Drum’n’Bass Kit** of timbre 4. The **Gt-Stab Rhythm** arpeggio pattern will play the program **Funkin’ Guitar** of timbre 2.
- If you uncheck “Arpeggiator Run A” or “Arpeggiator Run B,” the unchecked arpeggiator will stop.

If you check it once again and play the keyboard, the arpeggiator will begin running.

- Look at the COMBI 7: Ed-Arp/Ctrls, Scan Zone page, and you will see that the A keys “Btm” and “Top” are set so that arpeggiator A will operate only for B3 and lower keys, and that the B “Top Key” and “Bottom Key” are set so that arpeggiator B will operate only for C4 and higher keys.

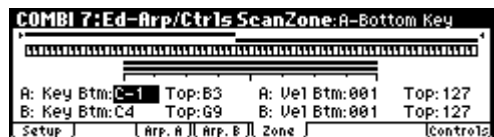

### Dual polyphonic arpeggiator settings

The dual polyphonic arpeggiator functionality lets you do the following things.

- Assign an arpeggiator for each timbre. Choose from Off, (arpeggiator) A, or (arpeggiator) B. step 5
- Independently specify whether A and B will operate. step 6

- Select an arpeggio pattern and set parameters independently for A and B. (step 7)
- Make Scan Zone page settings so that you can use keyboard range or playing velocity to switch between normal playing and arpeggiated playing, or to switch between arpeggiators A and B. (step 8)
- Make settings for timbres that will be silent when the arpeggiator is Off, and will sound only when the arpeggiator is On. (step 10)

### Arpeggiator on/off

Each time you press the [ARP ON/OFF] button, the arpeggiator will be switched on or off. When on, the [ARP ON/OFF] button will light. The selected arpeggio pattern will begin when you play the keyboard. The on/off setting is saved when the combination is written into memory.

*Note:* If “Assign” is **Off** or “Arpeggiator Run” is not **checked**, the arpeggiator will not operate even if this key is on.

### Arpeggiator settings

1. Select COMBI 0: Play, Prog page.  
Select programs for the timbres that you wish to use. For this example, select any desired program for timbres 1–4.
2. Select COMBI 2: Ed–TimbreParam. MIDI page.  
For the timbres that you will be using, set “Status” to INT, and set “MIDI Channel” to Gch or to the global MIDI channel (set in GLOBAL 1: MIDI “MIDI Channel”).  
For this example, set timbres 1–4 to a “Status” of INT, and timbres 5–8 to a “Status” of Off. Set the “MIDI Channel” of timbres 1–4 to Gch.

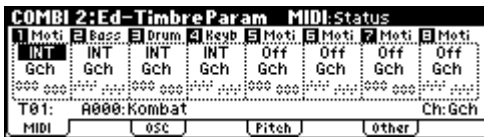

3. Select COMBI 7: Ed–Arp/Ctrls, Setup page.

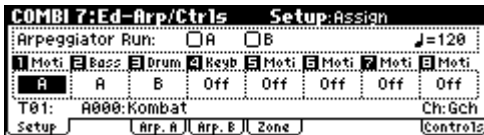

4. Set “J (Temp)” to specify the tempo.  
This is the same as for a program (p.92). However, the tempo is shared by both arpeggiators A and B.
5. Make “Assign” settings.

- Assign arpeggiator A or B to the desired timbres. Each timbre will be played by the arpeggiator that has been assigned to it.
6. Make “Arpeggiator Run” settings.

**Check** the arpeggiator(s) that you want to operate. The arpeggiator(s) checked here will run when the [ARP ON/OFF] button is turned on.

With the settings shown in the display for steps 2 and 3, turning the [ARP ON/OFF] button on will cause arpeggiator A to operate for timbres 1 and 2, and arpeggiator B to operate for timbre 3. When the [ARP ON/OFF] button is turned off, timbres 1–4 will sound as a layer.

If all timbres “Assign” are **Off**, or if neither “Arpeggiator Run” A or B is **checked**, the arpeggiator will not function.

7. In the Arp. A and Arp. B pages, set the parameters for arpeggiators A and B.  
The parameters for A and B are the same as for a program (p.92).

8. In the Scan Zone page, specify the range in which arpeggiators A and B will operate.  
The parameters for A and B are the same as for a program (p.94).

You can use keyboard ranges or playing velocity to operate the arpeggiator, or to switch between arpeggiators A and B. By using the COMBI 5: Ed–Key Zone, Key page and COMBI 6: Ed–Vel Zone, Vel page to set keyboard ranges and velocity ranges in conjunction with each other, you can create even more variations.

9. If you wish to save the edited combination settings in internal memory, turn off memory protect in Global mode, and write the combination.

In the GLOBAL 0: System, Preference page, uncheck the Memory Protect “Combination” check box. (p.88)

10. The “Status,” “MIDI Channel” and “Assign” settings shown in the display of steps 2 and 3 can be made so that certain timbres will sound only when the arpeggiator is On, and will be silent when the arpeggiator is not Off.

### Setting examples

Although this is a somewhat sophisticated editing technique, we will describe the settings of one of the preset combinations as an example.

#### Combination B021: Urban Nature RnB

Select combination **B021: Urban Nature RnB**, and play it.

Before you play, make sure that the global MIDI channel (GLOBAL 1: MIDI “MIDI Channel”) is set to **01**.

- Arpeggiator **A** is assigned to **T** (timbre) **4** and **5**. When you play the keyboard, the arpeggio pattern **Dr-Nature RnB** will sound only the **T4** program **Trance/GarageKit**.
- The arpeggio pattern uses the **Fixed Note** setting, which is appropriate when playing a drum arpeggio. (“Fixed Note” is **checked** in, GLOBAL 5: Arp.Pattern, Setup page.) With this setting, the arpeggio pattern will always play the specified pitches regardless of the note numbers received from the keyboard. (ⓘp.102)
- The A “Key Btm” and “Key Top” (COMBI 7: Ed-Arp/Ctrls, Scan Zone page) are set so that arpeggiator **A** will operate only for notes **B3** and lower.
- Arpeggiator **A** is also assigned to **T5**, but this is so that the **T4** program **Trance/GarageKit** will sound only when the arpeggiator is on.

**Notice the timbre settings for T4 and T5**

	Status	MIDI Channel	Assign
T4	INT	02	A
T5	Off	Gch	A

- If the arpeggiator is off, playing the keyboard will sound the timbre(s) that are set to **Gch** or to the global MIDI channel (in this case, **01**). Since the “MIDI Channel” of **T4** is set to **02**, it will not sound. **T5** is set to **Gch**, but since “Status” is **Off** it will not sound.
- Any MIDI channel that is assigned to a timbre will trigger the arpeggiator. In this case, these will be “MIDI Channel” **02** and **Gch** (global MIDI channel). When the arpeggiator is on, playing the keyboard will trigger arpeggiator **A** which is assigned to **T5 (Gch)**. **T4** will be sounded by arpeggiator **A**. Since the “Status” of **T5** is **Off**, it will not sound.
- Since the “Status” of **T5** is **Off**, it will not sound, regardless of whether the arpeggiator is on or off. It is a dummy timbre that causes **T4** to sound only when the arpeggiator is on.

#### Combination B071: “In The Pocket”

Select and play combination B071: “In The Pocket.”

Before you play, make sure that the global MIDI channel (GLOBAL 1: MIDI “MIDI Channel”) is set to **01**.

- Arpeggiator **A** is assigned to **T7** and **T8**, and arpeggiator **B** is assigned to **T5**. When you play the keyboard, the **T7** program **HipHop Kit** will be sounded by the arpeggio pattern **Dr-In The Pocket**. The **T5** program **Chord Trigger** will be sounded by the arpeggio pattern **Bs-Echo**.
- The B “Key Btm” and “Key Top” (COMBI 7: Ed-Arp/Ctrls, Scan Zone page) are set so that arpeggiators **B** will operate only for the **G3** note and above.
- Arpeggiator **B** is assigned to **T8** as well, but this setting is so that the **T7** program **HipHop Kit** will sound only when the arpeggiator is on. See the preceding section “Combination B021: Urban Nature RnB.”

---

### Writing the arpeggiator settings

Arpeggio parameters you edited in Combination or Multi mode are saved along with the settings when you write the combination or multi set. For the writing procedure, see “Saving your edits” (ⓘp.61) for a combination, or to “Saving your edits” (ⓘp.75) for a multi set.

---

### Linking the arpeggiator to the combination

If you want the arpeggiator settings of a combination to become active when that combination is selected, **check** “Combi” for “Auto Arp” (GLOBAL 0: System, Basic page).



## Creating a user arpeggio pattern

User arpeggio patterns can be created in Global mode.

- When you play the keyboard in Global mode, the instrument will sound in the state of the mode in which you were.
- If you moved from Multi mode to Global mode, playing the keyboard will sound the program and arpeggiator of the track that matches the global MIDI channel (GLOBAL 1).

## Memory structure for the arpeggio patterns

The microX has 251 arpeggio pattern memory areas, divided into preset arpeggio patterns and user arpeggio patterns as follows.

**Preset arpeggio patterns:** There are five patterns; **UP**, **DOWN**, **ALT1**, **ALT2**, and **RANDOM**. The operation of these patterns is fixed, and cannot be edited.

**User arpeggio patterns:** There are 251 patterns - **U000–U250** - which can develop chords or phrases in a wide variety of ways, based on the pitches that you play on the keyboard or the timing at which you play them.

In GLOBAL 5: Arp.Pattern you can modify these user arpeggio patterns, or create a new user arpeggio pattern from an initialized condition. Edited user arpeggio patterns can be written to internal memory areas **U000–U250**.

## Changing the memory protect setting

When you wish to edit a user arpeggio pattern, first turn off memory protect by **unchecking** the Memory Protect “Arp. UsrPat” check box in the GLOBAL 0: System, Preference page.

## Saving and comparing data

- The edits you perform in Global mode will be preserved until you turn off the power is turned off, but will be lost when the power is turned off. Four types of data are handled in Global mode: user drumkit settings (GLOBAL 4), arpeggiator settings (GLOBAL 5), external control settings (GLOBAL 6), and all other global settings (GLOBAL 0–3). You into its own memory area.

- Note that **Compare** can't be used in Global mode. If you want to edit a user drum kit or user arpeggio pattern, you should first use “Copy Drum Kit” or “Copy Arpeggio Pattern” to copy the drum kit or user arpeggio pattern you want to edit into a vacant number, and then edit the copy.

## Caution when the arpeggiator is used by multiple programs or combinations

When you edit a user arpeggio pattern, the changes will have an effect on any Program, Combination, or Multi set that uses this same pattern.

## Initializing an arpeggio pattern

With the factory settings, all of the microX's user arpeggio patterns U000–U250 contain preloaded data.

If you want to create a new arpeggio pattern, choose an appropriate arpeggio pattern and initialize it.

*Note:* Even if you've initialized a pattern, you can reload the factory preset data at any time using the Global mode. (p.113)

1. Press the [GLOBAL] button to enter Global mode, and access the GLOBAL 5: Arp.Pattern, Setup page.
2. Select the arpeggio pattern that you want to initialize.



3. Access the GLOBAL 5: Arp.Pattern, Edit page.
4. Press the [UTILITY] button. From the menu that appears, choose “Initialize Steps” to open the dialog box.



5. If you set “Type” to Empty, the pattern will be initialized to an empty state without any tones. If you select Full, all tones will be occupied. In this example, choose Empty and press the [MENU/OK] button. The pattern will be initialized.

## Editing a user arpeggio pattern in Program mode

If you enter this mode from the Program mode, your editing will apply to the arpeggio pattern specified for the selected program.

1. In Program mode, select a program for which the arpeggio pattern you wish to edit is selected, or a program that you wish to use as a basis for editing the arpeggio pattern.

2. Press the [ARP ON/OFF] button to turn the arpeggiator on (the button will light).

Even if you moved to Global mode from a program in which the arpeggiator was turned off, you can use the [ARP ON/OFF] button to turn it on.

3. Access the GLOBAL 5: Arp.Pattern, Setup page.



4. In "Pattern," select the arpeggio pattern that you wish to edit.

For this example, select an empty user arpeggio pattern.

If a blank pattern is selected, playing the keyboard will not start an arpeggio.

*Note:* Although preset arpeggio patterns **Preset-0-Preset-4** can be selected, they cannot be edited.

5. In "Lgth (Length)," specify the length of the pattern.

After the pattern has played for the length specified, it will return to the beginning. This setting can also be changed during or after editing. For this example, set it to **8**.

6. Make settings for the "♩ (Tempo)," "Reso (Resolution)," "Oct (Octave)," "Sort," "Latch," "K.Sync (Key Sync.)," and "Kbd (Keyboard)" parameters.

*Note:* These are program parameters, but can be set from here as well.

If after moving here from Program mode, you modify these parameters and wish to keep your changes, return to Program mode and write the program. These parameters are not saved by "Write Arpeggio Pattern."

For this example, make the settings shown in the illustration 3.

7. The "Type (Arpeggio Type)," "Octave Motion," and "Fixed Note" parameters specify how the arpeggio will be developed.

These settings can be changed during or after editing.

8. Access the Edit page.

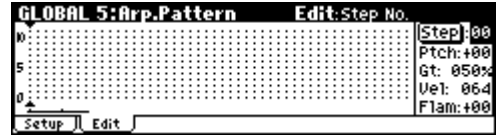

A pattern consists of **Steps** and **Tones**.

- **Step:** A user arpeggio pattern can have a maximum of 48 steps. The arpeggiator will play from the first step, in steps equal to the timing value specified by "Reso (Resolution)." The vertical lines of the grid shown in the center of the display indicate the steps.

Use "Step (Step No.\*)" to select the step. For each step, specify "Ptch (Pitch Offset)," "Gt (Gate)," "Vel (Velocity)" and "Flam."

To change the step, use the ClickPoint to select "Step" (Step No.), and then use the [VALUE] dial to select the desired step. In this page you can use the ClickPoint [◀][▶] to move between steps.

- **Tone:** At each step, a chord consisting of up to 12 tones (Tone No. **00-11**) can be sounded.

The grid of horizontal dotted lines in the center of the display indicate the tones.

When "Step (Step No.\*)" is selected, you can press the center of the ClickPoint to specify the tone.

Use the ClickPoint [▲][▼] to select a tone, and press the center to enter that tone. The tone will switch on/off each time you press the center.

Use the ClickPoint [◀][▶] to move to the next or previous step. Select a step, use [▲][▼] to select a Tone, and then press the center to enter.

Press the [MENU/OK] button when you're finished.

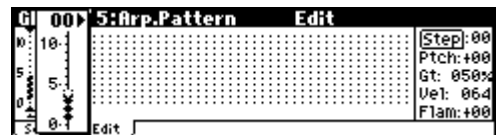

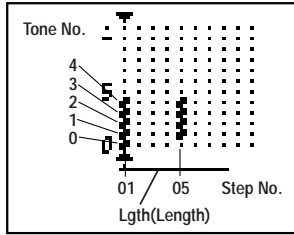

### Creating an example pattern

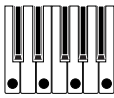

1. Set "Step (Step No.)" to 01, and press the center of the ClickPoint.
2. Select Tone 0, and press the center of the ClickPoint.
3. Use the ClickPoint [▶] to change "Step" to 02, and enter Tone 1.
4. In the same way, change "Step" to 03 and enter Tone 2.
5. Set "Step" to 04 and enter Tone 1.
6. Set "Step" to 05 and enter Tone 3.
7. Set "Step" to 06 and enter Tone 1.
8. Set "Step" to 07 and enter Tone 2.
9. Set "Step" to 08 and enter Tone 1.
10. Press the [MENU/OK] button.

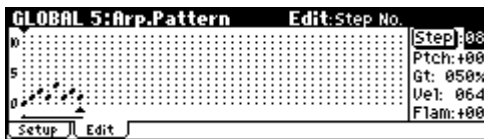

11. When you play the keyboard as shown in the illustration, the arpeggiator will begin playing.  
**Tone 0** corresponds to the pitch of the lowest key of chord you play on the keyboard. (If "Sort" is **unchecked**, it will correspond to the pitch of the first note you play.)
12. For steps 01–08, make settings for "Ptch (Pitch Offset)," "Gt (Gate)," "Vel (Velocity)," and "Flam."

**"Ptch (Pitch Offset)":** This offsets the pitch of the arpeggio note in semitones up or down. You can input the same tone for each step, and change the "Ptch (Pitch Offset)" value for each

to create a melody using a single tone. (☞ "Melody pattern")

**"Gt (Gate)":** Specify the length of the arpeggio note for each step. With a setting of **LGT**, the note will continue sounding either until the next note of the same tone or until the end of the pattern. With a setting of **Off**, the note will not sound.

**"Vel (Velocity)":** Specify the strength of the note. With a setting of **Key**, the note will sound at the strength with which it was actually played.

*Note:* The "Gt (Gate)" and "Vel (Velocity)" settings you make here will be valid if the "Gt (Gate)" and "Vel (Velocity)" parameters (PROG 7: Ed-Arp/Ctrls, Setup page) of the program selected in Program mode are set to **Step**. If these parameters have a setting other than **Step**, the "Gt (Gate)" and "Vel (Velocity)" that were specified for each individual step will be ignored, and all notes of the arpeggio will sound according to the settings in PROG 7: Ed-Arp/Ctrls. Be sure to verify the settings of the program.

*Note:* Before you set "Gt (Gate)," move the REALTIME CONTROLS C-mode [ARP-GATE] knob to the center position (12 o'clock).

*Note:* Before you set "Vel (Velocity)," move the REALTIME CONTROLS C-mode [ARP-VELOCITY] knob to the center position (12 o'clock).



13. To change the user arpeggio pattern name, use the Utility "Rename Arpeggio Pattern" (☞ p.114).
14. If you wish to save the edited user arpeggio pattern to internal memory, be sure to Write the user arpeggio pattern (☞ p.104).  
 If you turn off the power without writing, the edited contents will be lost.
15. If you wish to save the state of the program at the same time, return to Program mode and write the program (☞ p.45).

## Other examples of creating a user arpeggio pattern

### Melody pattern

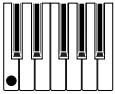

1. Set "Step (Step No.)" to 01, and press the center of the ClickPoint.
2. Select Tone 0, and press the center of the ClickPoint.
3. Use the ClickPoint [▶] to change "Step" to 02, and enter Tone 0.
4. In the same way, change "Step" to 03 and enter Tone 0.
5. Set "Step" to 04 and enter Tone 0.
6. Set "Step" to 05 and enter Tone 0.
7. Set "Step" to 07 and enter Tone 0. (We won't enter a tone in "Step" 06.)
8. Set "Step" to 08 and enter Tone 0.
9. Press the [MENU/OK] button.
10. Use the [VALUE] dial to change "Step (Step No.)" to the appropriate step. Use the ClickPoint to select "Ptch (Pitch Offset)" and make the following settings.

- Set the Step 01 "Ptch (Pitch Offset)" to +00.
- Set the Step 02 "Ptch (Pitch Offset)" to +10.
- Set the Step 03 "Ptch (Pitch Offset)" to +00.
- Set the Step 04 "Ptch (Pitch Offset)" to +00.
- Set the Step 05 "Ptch (Pitch Offset)" to +12.
- Set the Step 07 "Ptch (Pitch Offset)" to +00.
- Set the Step 08 "Ptch (Pitch Offset)" to -02.

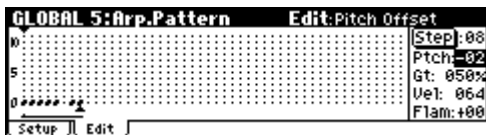

### Chordal pattern

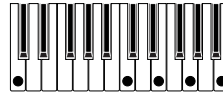

1. Set "Step (Step No.)" to 01, and press the center of the ClickPoint.
2. Select Tone 0, and press the center of the ClickPoint.
3. Use the ClickPoint [▶] to change "Step" to 03, and enter Tones 1, 2, 3, and 4. (We won't enter a tone in Step 02.)
4. In the same way, change "Step" to 04, and enter Tones 1, 2, 3, and 4.
5. Change "Step" to 06, and enter Tones 1, 2, 3, and 4. (We won't enter a tone in Step 05.)
6. "Step" to 08, and enter Tones 1, 2, 3, and 4. (We won't enter a tone in Step 07.)
7. Press the [MENU/OK] button.
8. Use the [VALUE] dial to change "Step (Step No.)" to 01. Use the ClickPoint to select "Gt (Gate)" and change it to LGT.
9. Use the [VALUE] dial to change "Step (Step No.)" to 06. Use the ClickPoint to select "Gt (Gate)" and change it to LGT.

*Note:* To simulate the timing nuances of a strummed guitar chord, select "Flam." In Program mode, select an acoustic guitar program, and choose the user arpeggio pattern that you created here. In the Setup page of PROG 7: Ed-Arp/Ctrl, Setup, set "Gate" to Step.

Then return to the GLOBAL 5: Arp.Pattern, Edit page. For odd-numbered steps, set "Flam" to a positive (+) value. For even-numbered steps, set "Flam" to a negative (-) value.

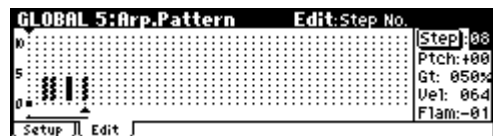

### Drum pattern

You can use the arpeggiator to play a rhythm pattern by using "Fixed Note" with a drum program.

1. Select a drum kit program.

For this example, select preset program B020: Standard Kit 1.

- Select the GLOBAL 5: Arp.Pattern, Setup page, and set the parameters.

Check "Fixed Note." If this is **checked**, tones will always sound at the specified pitch.

If you set "Mode (Fixed Note Mode)" to **Trigger All Tones**, playing a single note will cause all **Tones** to sound. If you set "Mode (Fixed Note Mode)" to **Trigger As Played**, the notes you play will determine how Tones are sounded.

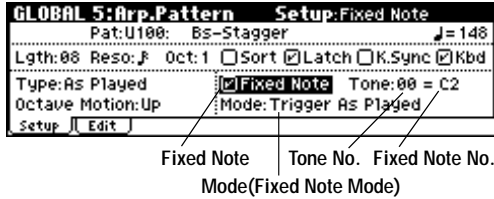

If "Fixed Note" is **checked**, you will be able to set "Tone No." and "Fixed Note No."

Select "Tone No.," and then set "Fixed Note No." to specify the note number that the tone will sound.

Here, set "Tone No." and "Fixed Note No." as follows.

Tone No.	Fixed Note No.
00	C2 (kick)
01	F2 (snare)
02	F#3 (closed hi-hat)
03	A#3 (open hi-hat)

The drumsamples that correspond to each note number will differ depending on the drum kit.

After you've used the keyboard to find the drum sound you want to use, you can enter "Fixed Note No."

- Access the Edit page.

Each **Tone** in the display will be shown as a small circle.

For each horizontal line (**Tone**) in the display, you will specify a drumsample (note number) of the drum kit.

Next we will input a rhythm pattern.

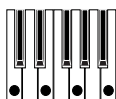
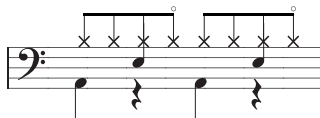

- Input the kick (Tone00).

Set "Step (Step No.)" to 01, and press the center of the ClickPoint. Enter Tone 00. Then set "Step (Step No.)" to 05 and enter Tone 0.

- Input the snare (Tone01).

Set "Step (Step No.)" to 03, and enter Tone 01. Then set "Step (Step No.)" to 07 and enter Tone 01.

- Input the closed hi-hat (Tone02).

Choose "Step (Step No.)" 01, 02, 03, 05, 06, and 07, and enter Tone 02 for each of these steps.

- Input the open hi-hat (Tone03).

Set "Step (Step No.)" to 04, and enter Tone 03. Then set "Step (Step No.)" to 08, and enter Tone 03.

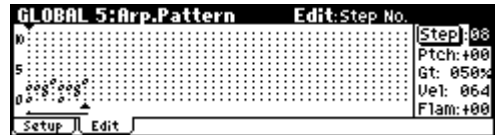

- Press the [MENU/OK] button.

If "Mode (Fixed Note Mode)" is set to **Trigger All Tones**, playing a single note on the keyboard will cause the rhythm pattern to play.

If "Mode (Fixed Note Mode)" is set to **Trigger As Played**, playing a single note on the keyboard will cause only the kick (**Tone00**) to play. Playing two notes on the keyboard will cause only the kick (**Tone00**) and snare (**Tone01**) to play. In this way, the number of keys that you play will be played by the same number of **tones**.

- Set the parameters for each step.

Use "Vel (Velocity)" etc. to add accents to the rhythm pattern.

*Note:* The "Gt (Gate)" and "Vel (Velocity)" settings you make here will be valid if the "Gate" and "Velocity" parameters (PROG 7: Ed-Arp/Ctrl, Setup page) of the program selected in Program mode are set to **Step**.

If these parameters have a setting other than **Step**, the "Gt (Gate)" and "Vel (Velocity)" that were specified for each individual step will be ignored, and all notes of the arpeggio will sound according to the specified gate and velocity.

*Note:* Before you set "Gate," move the REALTIME CONTROLS C-mode [1] (ARP-GATE) knob to the center position (12 o'clock).

*Note:* Before you set "Velocity," move the REALTIME CONTROLS C-mode [2] (ARP-VELOCITY) knob to the center position (12 o'clock).

### Dual polyphonic arpeggiator editing in Combi and Multi modes

Here we will use a combination as an example in our explanation.

The same procedure applies when editing an arpeggio pattern in Multi mode.

If you have entered this mode from the Combination mode, the arpeggio pattern selected by the combination will be affected by your editing.

1. In Combination mode, select a combination that uses the arpeggio pattern you wish to edit. For this example, select a combination to which arpeggiators A and B is assigned.
2. Press the [ARP ON/OFF] button to turn on the arpeggiator (the button will light).

Even if the arpeggiator had been turned off when you moved here, you can use the [ARP ON/OFF] button to turn it on. However, if “Arpeggiator Run” A or B are not checked, and if no timbres have been assigned in “Assign,” then the arpeggiator will not operate.

3. Access the GLOBAL 5: Arp.Pattern, Setup page.

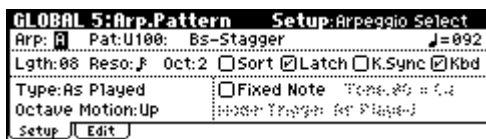

4. If you moved here from Combination mode, use the “Arp (Arpeggio Select)” A and B to select the arpeggiator that you wish to edit. If this is A, your editing will apply to the parameters and user arpeggio pattern of arpeggiator A. If this is B, your editing will apply to the parameters and user arpeggio pattern of arpeggiator B.
5. Switch between arpeggiators A and B, and edit their respective user arpeggio patterns. If you wish to stop one of the arpeggiators, return to Combination mode, and in COMBI 0: Play, select the Arp. A or the Arp. B page and **uncheck** the “Arpeggiator Run” check box.
6. To modify the name of a user arpeggio pattern, use the Utility “Rename Arpeggio Pattern” (p.114).
7. If you wish to save the edited user arpeggio pattern in internal memory, you must write the user arpeggio pattern.

In this case, both user arpeggio patterns will be written simultaneously. If you turn off the power without writing, the edited contents will be lost.

8. If you wish to save the state of the combination at the same time, return to Combination mode and write the combination (p.61).

*Note:* When editing a user arpeggio pattern, pay attention to the global MIDI channel, the channel of each track, and the arpeggiator assignments, and make sure that the arpeggiator you are hearing is the pattern that you wish to edit.

### Assigning a name

We recommend that you assign a name to the arpeggio pattern you create.

You can do this by using the “Rename Arpeggio Pattern” utility. For details on assigning a name, see p.114.

### Saving a user arpeggio

When you’re finished editing, you should save the user arpeggio.

The “Tempo,” “Pattern,” “Octave,” “Resolution,” “Sort,” “Latch,” “Key Sync.,” and “Keyboard” settings of a user arpeggio pattern are parameters that are saved together with the program, combination, or multi set. These parameters are not saved by the Write operation described here. If you want to save these parameters, return to the previous mode and write the data.

*Note:* You’ll need to turn off the memory protect setting for user arpeggio patterns. In the GLOBAL 0: System, Preference page, uncheck the Memory Protect “Arp. UsrPat” box. (p.88)

1. Press the [UTILITY] button to access the utility menu, and choose “Write Arpeggio Patterns.”
2. To write (save) your settings, press the [MENU/OK] button. A dialog box will ask you to confirm that you want to write the arpeggio patterns.
3. Press the [MENU/OK] button to write your settings, or press the [EXIT/CANCEL] button if you decide not to write.

The arpeggio patterns will be written (saved).

---

## Synchronizing the arpeggiator

The note timing of the arpeggiator will differ depending on the state of the arpeggiator “Key Sync.” check box.

If this is **checked**, the arpeggiator will immediately start playing from the beginning from the first note-on you play after all the keys had been previously released.

If this is **unchecked**, the arpeggiator will operate in synchronization with the internal or external MIDI clock.

The paragraphs below explain how synchronization occurs when the “Key Sync.” check box is **unchecked**. (However, synchronization with Song Start and with the MIDI realtime command Start message are exceptions to this.)

---

### Synchronization between arpeggiators A and B

In Combination and Multi mode, two arpeggiators can operate simultaneously. In this case, if you start an arpeggiator (whose “Key Sync.” is **unchecked**) while the other arpeggiator is already running, the arpeggiator you started will synchronize to the “♪ (Tempo)” based on the timing of the already-running arpeggiator.

*Note:* If “Key Sync.” is **checked**, A and B will each operate on their own timing.

---

### Synchronization with an external sequencer in Program, Combination, or Multi modes

#### When the microX is the master

If “♪ (Tempo)” is INT, the arpeggiator will operate based on the timing of the internal MIDI clock.

“♪ (Tempo)” will be INT if GLOBAL 1: MIDI “MIDI Clock” is Internal. The tempo will also be INT if the Auto setting is selected and MIDI clock is not being received from an external device.

#### When the microX is the slave

If “♪ (Tempo)” is EXT, the arpeggiator will synchronize to the MIDI clock and Start messages etc. received from the external MIDI sequencer or similar device.

“♪ (Tempo)” will be EXT if GLOBAL 1: MIDI “MIDI Clock” is Ext-MIDI or Ext-USB. The tempo will also be EXT if the Auto setting is selected and MIDI clock is being received from an external device.

#### Synchronization to external MIDI clock

- The arpeggiator will synchronize to the “♪ (Tempo)” based on the timing of the external MIDI clock.

#### Synchronization to the MIDI Start message

- When the arpeggiator is on and operating, receiving a MIDI Start message will cause the arpeggiator to reset to the beginning of the pattern. (This has no relation to the “Key Sync.” setting.)





# Using Drum Kits

## What is a Drum Kit?

Drum Kits, as the name implies, are optimized for creating drum sounds. Drum Kits are created in Global Mode. They offer a number of special features, such as:

- Each note can play a different sound
- On each note, you can use up to two Drum Samples, with velocity switching
- Each note has separate settings for the most important sound parameters, including volume, filter cutoff and resonance, envelope attack and decay, pitch.
- You can specify the insert effect routing and master effect send level for each note. For example, you can use this to send just the snare to a compressor.

You can use Drum Kits only in Programs whose “Oscillator Mode” is set to “Drums.”

## Drum Kit memory structure

The microX has 49 Drum Kits, divided into Internal, User, and GM (General MIDI) groups as shown below.

You can edit or write into any of the locations except for the GM bank, which cannot be erased.

If you want to start with a GM bank drum kit and edit it, use the “Copy Drum Kit” utility to select a drum kit and copy it to the USER bank.

### Drum Kit banks

Bank	No.	Contents
INT	00...31	Factory Drum Kits
USER	32...39	User (initialized) Drum Kits
GM	40...48	GM2 Drum Kits

## Drum Kit Programs and Oscillator Mode

The PROG 1: Ed-Basic, Prog Basic page “Oscillator Mode” setting specifies whether the oscillator will be a drum kit or a conventional multisample (such as piano or strings).

You can verify this setting in the PROG 2: Ed-Pitch, OSC1 page. If “Oscillator Mode” is set to Single, you’ll be able to specify two multisamples and a velocity switch. If this is set to Double, you’ll be able to make an additional set of settings in the OSC2 page.

If “Oscillator Mode” is set to “Drums,” you’ll be able to make settings for one drum kit. A drum kit does have velocity switch settings, but these settings are made for the drum kit in Global mode, and cannot be edited or saved in Program mode.

## Before you start editing...

### First, select a Drum Program

In Global Mode, you’ll play the kit that you’re editing as if you were playing it from within the Program, Combination, or Multi set which was selected before you entered Global mode.

So, before you enter the GLOBAL 4: DKit pages, it’s best to select a Program which is already set up for drums in Program mode, with the appropriate EG settings, effects, and so on. Choose a drum Program such as “B020: Standard Kit 1.”

If you moved from Multi mode to Global mode, playing the keyboard will sound the program and arpeggiator of the track that matches the global MIDI channel (GLOBAL 1).

### Match the note mapping and key position for the drum kit

In order for the note mappings to match the keyboard, the Oscillator’s **Octave** setting needs to be **+0 [8']**. All Drum Kit Programs should have this setting already. If you’re unsure, you can check this yourself:

1. Access the Program mode PROG 1: Ed-Basic, OSC1 page.
2. Check that the “Octave” parameter (near the top of the page) is set to **+0 [8']**.

With a setting other than **+0 [8']**, the relationship between the keys and the Drum Kit sound map will be incorrect.

### Check the memory protect setting

When you wish to edit a user drum kit, first turn off memory protect by unchecking the Memory Protect “Drum Kit” check box in the GLOBAL 0: System Preference page.

## Saving and comparing data

- The edits you make in Global mode will be lost when the power is turned off, so you need to write (save) your edits if you want to keep these changes. Four types of data are handled in Global mode: user drumkit settings (GLOBAL 4), arpeggiator settings (GLOBAL 5), external control settings (GLOBAL 6), and all other global settings (GLOBAL 0–3). You can save each type of data into its own memory area.
- Note that **Compare** can't be used in Global mode. If you want to edit a user drum kit or user arpeggio pattern, you should first use "Copy Drum Kit" or "Copy Arpeggio Pattern" to copy the drum kit or user arpeggio pattern you want to edit into a vacant number, and then edit the copy.

## Caution when a drum kit is used by more than one program

When you edit a drum kit, your changes will affect all programs that use that same drum kit. If you want to edit one of the preloaded drum kits, it is best to copy the drum kit into a vacant area of the USER bank, and then edit the copy of the drum kit.

## Editing Drum Kits

### Basic Editing

1. Select the Program that you wish to use while editing the Drum Kit.  
For more details, see "First, select a Drum Program" (p. 107).
2. Press the [GLOBAL] button to enter Global mode.
3. Access the GLOBAL 4: DKit, High Sample page.



4. Use the "Drum Kit" parameter, at the top of the screen, to select the Drum Kit that you wish to edit.
5. Use the "Key" parameter to select the note that you wish to edit.  
Use the front panel [VALUE] dial etc. to edit the setting.  
This "Key" selection applies to all three Drum Kit editing tabs.
6. Use the "Assign" check box to specify whether the key will have its own settings, or use the same settings as the next higher note.  
If "Assign" is **checked**, the key will have its own settings. This is the default.  
If "Assign" is **not checked**, the key won't have its own settings. Instead, it will use the same settings as the next higher note—except that the drum samples will be played at a lower pitch. The pitch that sounds will depend on the PROG 2: Ed–Pitch, OSC1 page "Pitch Slope" setting.  
Use this setting when you want only to change the pitch, such as with tom or cymbal sounds.

### Placing drum samples

Here's how to place two drum samples and switch between them using velocity.

1. Access the GLOBAL 4: DKit, High Sample page.
2. Select the High "Drum Sample."  
Press the [CATEGORY] button to view a list of the drum samples organized by category. For

details on how to make a selection, see “Selecting by Category” (p. 38).

3. Select a drum sample name in the list so that it is highlighted.
4. Press the [MENU/OK] button to confirm the selection.
5. Press the [PAGE+] button to access the GLOBAL 4: DKit- Low Sample page.
6. Specify the Low Drumsample as you did in steps 2–4.

Now you have assigned drum samples to the High Drumsample and Low Drumsample. Next, we’ll assign the velocity range for these drum samples.

7. Set the “Velocity SW L→H”.

The Low drum sample will sound when you play a key less strongly than the specified velocity value, and the High drum sample will sound when you play more strongly.

For example if you set “Velocity SW L→H” to 100, the drum sample assigned to “Low” will sound when you play the keyboard softly, and the multisample assigned to “High” will sound when you play strongly.

*Note:* If you don’t want to use this function, set “Velocity SW L→H” to 001. Only the High drum sample will sound.

*Note:* This is the same type of function as velocity multisample switching in a program. (p.49)

## Fine-tuning the sound of each sample

1. If you like, adjust the Levels for the two Drum Samples.  
Set the High and Low “Level” settings to adjust the volume balance.
2. Set the tuning and EG parameters as desired.  
For each Drum Sample, you can control offsets to the Program’s settings for transposition, tuning, and EG attack and decay times.
3. You can adjust the sound or specify reverse playback for each drum sample.  
For each drum sample, set the “FC (Filter Cutoff)” and “Reso (Resonance)” parameters, and specify “S.Ofs” and “Rev (Reverse).” (p.87)
4. Repeat steps 1–3 to set up each key of the Drum Kit.

You can also copy settings from one “Key” to another, using the “Copy Key Setup” utility command.

## Using Exclusive Groups

1. Access the GLOBAL 4: DKit, Voice/Mixer page.
2. Use the Excl Group (Exclusive Groups) to make one drum sound cut off another drum sound - such as closed and open hi-hats.

For example, let’s say that you’ve assigned an open hi-hat and a closed hi-hat to the same exclusive group:

- Play the open hi-hat sound.
- While it’s still ringing, play the closed hi-hat.
- The open hi-hat sound will be cut off—simulating the action of a physical hi-hat.

## Using Hold

The Program **Hold** parameter can be especially useful for drum programs, since it lets the samples ring out naturally regardless of how long you hold down the note. The way that this works depends on settings in both the Program and the Drum Kit, as described below.

To enable **Hold**:

1. Access the PROG 1: Ed-Basic, Prog Basic page.
2. Voice Assign, make sure that the “Hold” check box is checked.  
Once you’ve turned on “Hold” for the Program, the function is controlled on a note-by-note basis according to settings within the Drum Kit.
3. Access the GLOBAL 4: DKit, Voice/Mixer page.

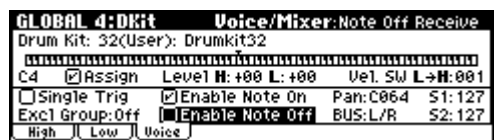

4. For each key, set the Enable Note Off Receive parameter as desired.

If this check box is unchecked, the key will be held. If it is checked, the key will not be held.

If you turn off “Hold” in the Program, no keys will be held - regardless of their “Enable Note Off Receive” setting.

---

### Controlling effects for each key

A drum kit lets you set the insert effect and master effect send for each key.

1. Access the PROG 8: Ed–InsertFX, BUS page.
2. Make sure that the “Use DKit Setting” check box is checked.

When “Use DKit Setting” is checked, the Program will use the “BUS Select” and Effects Send settings for each key of the Drum Kit.

When “Use DKit Setting” is unchecked, the Program will ignore the Drum Kit’s “BUS Select” and Effects Send settings.

3. Access the GLOBAL 4: DKit, Voice/Mixer page.
4. Use the “BUS Select” parameter to send drum sounds through their own Insert effect, or to the individual outputs.

If you like, you can send each note to its own Insert effect, or to the individual audio outputs, in addition to the main L/R outputs.

For example, you might send all snare sounds to **IFX**, and the remaining sounds to **L/R**.

5. Use “Send1(MFX1)” and “Send2(MFX2)” to set the send levels to the master effects.

---

### Setting the pan for each key

To use separate pan settings for each key:

1. Access the PROG 5: Ed–Amp1/2, Level/Pan page.
2. Under Pan, make sure that the “Use DKit Setting” check box is checked.

When “Use DKit Setting” is checked, the Program will use the pan settings for each key of the Drum Kit.

3. Access the GLOBAL 4: DKit, Voice/Mixer page.
4. Use the “Pan” parameter to specify the key’s stereo output position.

---

### Assigning a name

We recommend that you assign a name to the Drum Kit you create.

You can do this by using the “Rename Drum Kit” utility. For details on assigning a name, see p.114.

---

### Saving a drum kit

When you’ve finished editing your drum kit, you can save it.

*Note:* You’ll need to turn off the memory protect setting for drum kits. In the GLOBAL 0: System, Preference page, uncheck the Memory Protect “Drum Kit” check box. (ⓘp.88)

1. Press the [UTILITY] button to access the utility menu, and choose “Write Drum Kits.”
2. Press the [MENU/OK] button to write the drum kit data.

A dialog box will ask you for confirmation.

3. Press the [MENU/OK] button to save, or press the [EXIT/CANCEL] button if you decide not to save.

The drum kit data will be written (saved).

# External control settings

The microX's external control function lets you use the four REALTIME CONTROLS knobs to control an external MIDI device. You can specify the MIDI channel and MIDI control change that each knob will transmit.

One set of control settings consists of twelve such assignments (four knobs × three groups), and there are a total of 64 sets.

With the factory settings, the control sets contain preloaded data. For example, there are setups that let you control soft synthesizers such as the KORG Legacy Collection, and other setups that let you control the level and pan of a DAW (Digital Audio Workstation) program in realtime.

See the “microX External Control Template List” (PDF) for details on the control change (CC#) settings assigned by the preloaded external control templates and the application settings to which they correspond.

## Using external controls

### Selecting external controls

*Note:* Before you continue, adjust your settings so that the microX can send MIDI data to your computer application or MIDI device.

1. Press a PROGRAM [A]–[GM] button. (The button will light.)

We've selected Program mode as an example here, but you are free to select Combination or Multi mode if you wish.

2. Press the [EXT. CONTROLLER] button. (The button will light.)

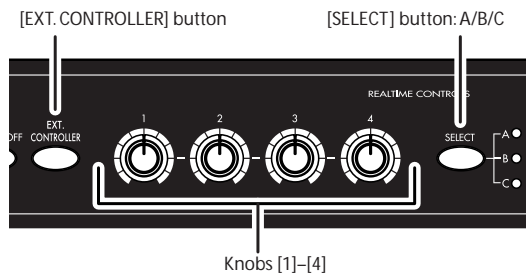

The 0: Play, Ext.Control page will appear.

PROG 0: Play		Ext.Control: Setup Select			
A	000:Kombat	♪=100			
Ext.Control: 00: KLC M1					
A	Gch: CC#008	Gch: CC#071	Gch: CC#074	Gch: CC#079	
B	Gch: CC#073	Gch: CC#075	Gch: CC#072	Gch: CC#091	
C	Gch: CC#007	Gch: Off	Gch: Off	Gch: Off	
Program F.Edit J_Arp J					[Ext.ctrl]

3. Choose “Setup Select,” and select the external control set that you want to use.

The set list is shown in the lower lines. The functions of the currently-enabled knobs are highlighted.

4. Press the [SELECT] button to select the functions (group) that will be controlled by the REALTIME CONTROLS [1]–[4] knobs.

5. When you turn knobs [1]–[4], the assigned MIDI control change (CC#) will be transmitted on the assigned MIDI channel.

*Note:* The microX's keyboard and other controllers will operate as usual.

6. Enter Combination or Multi mode, and operate the knobs.

The External Control function lets you use the REALTIME CONTROLS [1]–[4] knobs as independent controllers in any mode.

If the [EXT. CONTROLLER] button is on, changing programs in Program mode or switching to Combination mode etc. will not affect the control set. This means you can select another sound on the microX without changing the way you're controlling an external MIDI device, or conversely you can change the way you're controlling an external MIDI device without switching sounds on the microX.

## External control setups

You will use Global mode to create external control setups.

- The content that you edit in Global mode is preserved until you turn off the power, but will be lost when the power is turned off. There are four types of data that you manage in Global mode; user drum kit settings (GLOBAL 4), user arpeggio patterns (GLOBAL 5), external control settings (GLOBAL 6), and all other global settings (GLOBAL 0-3). You can write each of these into its own memory area.

### Selecting an external control setup and assigning control changes

1. Press the [GLOBAL] button to enter Global mode.
2. Access the GLOBAL 6: Ext.Control, Knob A page.

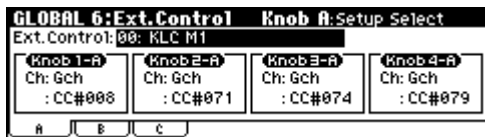

3. Use “Setup Select” to select the external control set that you want to edit.
4. Use Knob 1-A “MIDI Channel” to select the MIDI channel on which you want to transmit the message.

Next, use Knob 1-A “CC Assign” to specify the MIDI control change (CC#) that you want to transmit.

These two settings determine the CC# and MIDI channel of the message that is transmitted when (in Program mode etc.) you select this external control setup, use the [SELECT] button to select group A, and operate knob [1].

5. Next make settings for Knob 2-A through Knob 4-A, and then use the [SELECT] button to select groups B and C, and specify the channel and message transmitted by Knob 1-B–Knob 4-B and Knob 1-C–Knob 4-C.

### Assigning a name

It’s a good idea to name any external control setups that you create so that you can remember its purpose.

Use the “Rename Ext. Control Setup” utility to assign a name. For more details, see page 124.

## Saving an external control setup

When you’ve finished editing, save your external control setup.

*Note:* You’ll need to turn off external control memory protect. In the GLOBAL 0: System, Preference page, uncheck the Memory Protect “Ext. Control” item. (p.88)

1. Press the [UTILITY] button to access the utility menu, and choose “Write Ext. Control Setup.”
2. To write (save) your settings, press the [MENU/OK] button.

A dialog box will ask you to confirm that you want to write the settings.

3. Press the [MENU/OK] button to write your settings, or press the [EXIT/CANCEL] button if you decide not to write your settings.

# Other functions

## Restoring the factory settings (Loading the preloaded data)

If desired, you can restore the microX's programs, combinations, multi sets and Global mode settings to their factory-set state. You can do this by reloading the preloaded data.

⚠ This operation will rewrite any data that had been previously written to the internal memory. If you don't want to lose this data, you should save it using the included "microX Editor/Plug-In Editor"; or save the data using a commercially available data filer.

1. Press the [GLOBAL] button to enter Global mode. (The button will light.)
2. Press the [EXIT] button.  
You will be in the GLOBAL 0: System page.
3. Press the [UTILITY] button to access the Utility menu.
4. Use the ClickPoint [▼] to select "Load Preload Data," and press the center.

A dialog box will appear.



5. Choose "Kind," and use the [VALUE] dial to select the data that you want to load.  
Choose All if you want to restore all settings to the factory-set state. If you execute this with the "All" setting, all programs, combinations, multi sets, drum kits, arpeggio patterns, global settings, and external control sets will be loaded.
  6. Press the [MENU/OK] button.  
A dialog box will ask you to confirm the operation.
  7. Press the [MENU/OK] button once again.  
All preloaded data will be loaded.
- ⚠ If the "Memory Protected" dialog box appears, un-check the memory protect setting, and perform the load operation once again (p.88).

## Loading individual banks or data items

The microX allows you to load individual banks, programs, or combinations. Multi set, drum kits, arpeggio patterns and external controls can also be loaded individually or as a group.

This is convenient when you want to restore just one item from the factory preload data, or when you want to rearrange combinations in a specific order for live performance.

⚠ When rearranging programs, you need to be aware that if you write them to another bank or number, any combination that had used the program formerly occupying the writing destination will sound differently.

For example if you want to load combination A000 into C127, proceed as follows.

1. Access the dialog box as described in steps 1–4, above.



2. Choose "Kind," and use the [VALUE] dial etc. to select Combination.
3. Use the ClickPoint [▼] to move down, and use the [VALUE] dial to select Single.
4. In the same way, select combination A000 as the copy-source.
5. In the same way, select combination C127 as the load-destination ("To").
6. Press the [MENU/OK] button.  
A dialog box will ask you to confirm the operation.
7. Press the [MENU/OK] button once again.  
The data will be loaded, and the preloaded combination A000 will be copied into C127.

## Assigning a name (Rename)

You can modify the name of any program, combination, multi set, category, arpeggio pattern, etc.

The following table shows the items that you can rename, and the corresponding page.

Item to rename	Page
Program name	PROG 0...9 Utility: Write Program
Combination name	COMBI 0...9 Utility: Write Combination
Multi set name	MULTI 0-1 Utility: Rename Track
Track name	MULTI 0...9 Utility: Write Multi
Drum kit name	GLOBAL 4 Utility: Rename Drum Kit
Arpeggio pattern name	GLOBAL 5 Utility: Rename Arpeggio Pattern
External control set name	GLOBAL 5 Utility: Rename Ext. Control Setup
Program category name	GLOBAL 3: TEXT
Combination category name	GLOBAL 3: TEXT

1. Use the ClickPoint to select the text button (T), and press the center to open the text dialog box. See the table above for the appropriate page.

*Note:* In a utility menu command, select the text button (T) in the dialog box that appears.

In GLOBAL 3, select the text button (T) in the page.

The text dialog box will appear:



For example to enter the text shown in the illustration, you would proceed as follows.

2. Use the ClickPoint [◀][▶][▲][▼] to select "Clear."  
All text will be erased from the text box.
3. Enter "A".  
Use the [VALUE] dial to select "A".  
Press the ClickPoint [▶]. The cursor will move.

- You can enter text using just the ClickPoint.  
When you press the ClickPoint center, the square-framed cursor in the text box will change.  
Use the ClickPoint [◀][▶][▲][▼] to select a character. Press the center once again to finalize the selection.  
Use the ClickPoint [▶] to select the next character, and enter it in the same way.
- The function buttons shown in the lower line perform the following operations. Use the ClickPoint [◀][▶][▲][▼] to select a function, and press the center to execute it.

**Clear:** Erase all text.

**Del (Delete):** Delete the character at the cursor location.

**Ins (Insert):** Insert a space at the cursor location.

**Cap. (Capital):** Switch between uppercase and lowercase letters.

4. Enter the remaining characters as described in step 3.
5. Press the [MENU/OK] button.

If you opened the text dialog box from the utility dialog box in step 1, you will return to the previous dialog box. In that dialog box, press the [MENU/OK] button (twice) to execute the Rename operation.

If you opened the text dialog box from the GLOBAL 3 page in step 1, the Rename operation will be executed.



## Assigning functions to REALTIME CONTROLS B-mode knobs [1]–[4]

Here's how you can assign functions to REALTIME CONTROLS B-mode knobs [1]–[4].

The functions of these knobs in B-mode can be separately assigned for each program, combination, and multi set.

You will make these settings in “Knob B Assign” in the following pages.

Mode	Page
Program	PROG 7: Ed–Arp/Ctrls, Controls
Combination	COMBI 7: Ed–Arp/Ctrls, Controls
Multi	MULTI 7: Arp/Ctrls, Controls

- The default assignments for knobs 1–4 are Knob Mod.1 (CC#17), Knob Mod.2 (CC#19), Knob Mod.3 (CC#20), and Knob Mod.4 (CC#21), respectively. For a complete list of the possible assignments, see “Knobs 1...4 B Assign” (PG p.162).

Here's an example of how to set up knob [1] to control a Program's filter and amp EG attack time:

1. Press the [PROG] button to enter Program mode.
2. Access PROG 7: Ed–Arp/Ctrls, Controls.  
Press the [MENU/OK] button, use the ClickPoint to select “Arp/Controls,” and then press the center.
3. Choose Knob 1-B “Knob B Assign,” and use the [VALUE] dial etc. to select F/A Attack (CC#73).
4. Press the REALTIME CONTROLS [SELECT] button to select B-mode, and turn knob [1] to control the EG attack for the filter and amp.

*Note:* If you wish to keep these settings after the power is turned off, you must save the Program, Combination, or Multi set.

## Adjusting the display contrast

You can change the display contrast by adjusting the GLOBAL 0: System, Preference page “LCD Contrast” setting.

*Note:* If you wish to keep these settings after the power is turned off, you must save the Global mode.

## Tap tempo control

A tap tempo control function is available in Program, Combination, and Multi modes.

In each mode while the arpeggiator is playing, you can press the foot switch (when “Foot SW Assign” is set to Tap Tempo (p.88) several times at the desired tempo to control the playback tempo in realtime.

This function is convenient when you want to match the playback tempo of the arpeggiator playback to another beat in real-time.

The Tap tempo feature also provides real-time control over any BPM or tempo based effects.

The following example shows the procedure for using Tap tempo in Program mode.

1. In Program mode, select a drum program.  
You may find it convenient to choose from the Drum category.
2. In the PROG 0: Play, select the Arp. Play page and check the “Latch” check box.
3. Turn on the front panel [ARP ON/OFF] button.
4. Press the foot switch (when “Foot SW Assign” is set to Tap Tempo) several times at the desired tempo. The tempo “♩=” indication in the upper right of the display will change according to the playback tempo.  
When you play the keyboard, the arpeggiator will play a drum pattern at the specified tempo.
5. Lightly press the foot switch on the beat, and slightly shorten the intervals at which you press the button.  
The playback tempo of the drum pattern will speed up slightly.

*Note:* Tap tempo control can be used whenever the [TEMPO] knob can be operated.



# Appendices

## Saving data

### Types of data that can be saved

You can save data in the following ways.

- Write the data into the microX
- Save the data using the included “microX Editor/Plug-In Editor” software
- Send a MIDI data dump to a MIDI data filer or similar device

### Writing data into the microX

#### Data areas that you can write

You can write data into the following data areas. For the procedure, see the page given.

- Programs  
Programs 0–127 in banks A–E [p.45](#)
- Combinations  
Combinations 0–127 in banks A–C [p.61](#)
- Multi sets 000–127 [p.75](#)
- Global settings (pages 0–3) [p.87](#)
- Drum kit 00 (INT)–40 (User) [p.110](#)
- Arpeggio patterns U000–U250 [p.104](#)
- External control sets 00–63 [p.112](#)

You can't write to the following data areas.

- Program banks G: 001–128, g(d): 001–128
- Preset drum kits 40 (GM)–48 (GM)
- Preset arpeggio patterns  
Preset-0 – Preset-4
- Program audition riffs 000–383

When the microX is shipped, the writable areas already contain data. This data is referred to as the “preloaded data.” The preloaded data is also stored inside the microX, and can be reloaded using the “Load Preload Data” operation ([p.113](#)).

The non-writable areas contain preset data. This data cannot be rewritten.

### Modes and pages in which you can write data

You can write the following items of data in the corresponding pages.

Writable items	Page
Programs	PROG 0...9 Utility: Write Program
Combinations	COMBI 0...9 Utility: Write Combination
Multi sets	MULTI 0...9 Utility: Write Multi
Global settings	GLOBAL 0...3 Utility: Write Global Setting
Drum kits	GLOBAL 4 Utility: Write Drum Kits
Arpeggio patterns	GLOBAL 5 Utility: Write Arpeggio Patterns
External control sets	GLOBAL 6 Utility: Write Ext. Control Setups

### MIDI data dump

You can save data by transmitting it as MIDI exclusive data to a connected MIDI data filer, computer, or to a second microX unit. ([PG p.83](#))

The following data can be transmitted via MIDI data dump to an external data filer or similar device.

- Programs, combinations, multi sets, global settings, user drum kits, user arpeggio patterns, external control sets

### Using the “microX Editor/Plug-In Editor” control plug-in software to save data

You can use the “microX Editor/Plug-In Editor” control plug-in to save microX data. For more details, see “Editor/Plug-In Editor Manual” (PDF).

## About the Edit Buffer

### About the memory in Program, Combination, and Multi modes

When you select a program, combination, or multi set in PROG 0: Play, COMBI 0: Play, and MULTI 0: Play, the data of the selected program, combination, or multi set is called into the microX's edit buffer.

When you edit the parameters in pages such as 0: Play, your editing will modify the data in the edit buffer.

If you wish to save this modified data into internal memory, you must perform the Write operation.

When you perform the Write operation, the data in the edit buffer is written to the specified program number, combination number or Multi set number of the specified bank.

If you select another program, combination or Multi set number without writing, the data of the newly selected program, combination or multi set number will be called into the edit buffer, and your changes will be lost.

When you press the [COMPARE] button in these modes, the data in memory (i.e., the written content) is temporarily called into the edit buffer. This lets you compare the settings being edited with the settings prior to editing.

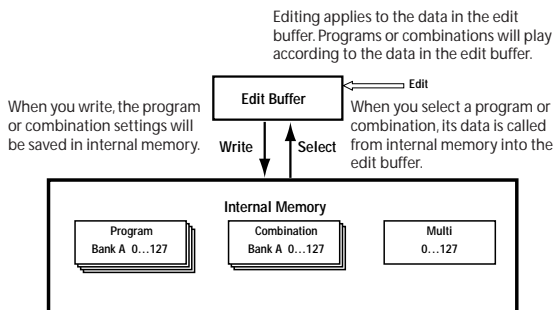

## Memory in Global mode

When the power is turned on, the Global mode data is called from internal memory into the Global mode memory area. Then when you modify the parameters in Global mode, the data in the memory area will be modified. If you wish to save this modified data in the internal memory, you must first Write (save) it.

When you write, the data in the memory area will be written into the global settings, drum kits arpeggio patterns, and external control sets of internal memory.

If you turn off the power without writing, the modified data in the memory area will be lost.

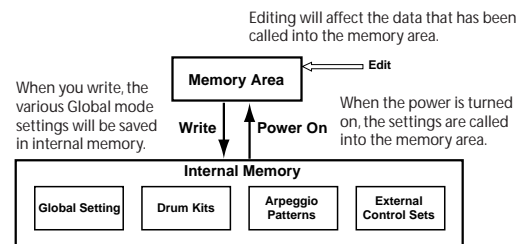

# Troubleshooting

If you experience problems, see the relevant item and take the appropriate measures.

---

## Power supply

### Power does not turn on

- Is the AC adapter connected to an outlet?  
☞p.23
- Is the Power switch turned on?  
→ Turn on the rear panel Power switch. ☞p.23

---

## Display

**The power is turned on, but nothing is shown in the display.  
The microX functions normally when you play the keyboard or perform other operations.**

- Due to changes in the surrounding temperature, the display may on rare occasions be difficult or impossible to read. If this occurs, perform the following procedure.
- 1. While holding down the [EXIT/CANCEL] button, press the [UTILITY] button. The [GLOBAL] button will blink, and the Global mode Update Global Setting dialog box will appear.

 If you are unable to read the display, or if the Update Global Setting dialog box does not appear, check whether the [GLOBAL] button is blinking. If the [GLOBAL] button is lit or dark, the microX may be writing data that was received from an external connected MIDI device, or may be responding to a request for output. If so, make sure that the microX is not writing data from an external connected MIDI device or transmitting data in response to a request, or that any such operation has been completed. Then turn the power of the microX off and on again, and repeat this procedure from step 1.

- 2. Use the [VALUE] dial to adjust the LCD contrast.
- 3. Press the [MENU/OK] button.  
The LCD contrast setting will be memorized.

*Note:* Other global settings will also be memorized at this time.

**The power is turned on, but the display does not display normally, or an error message is displayed. There is no sound when you play the keyboard, and the microX does not function normally.**

- This type of problem may occur if a data writing operation to internal memory was not completed correctly, for example if the power of the microX was turned off while a program or other data was being written. If this occurs, use the following procedure to initialize the microX's internal memory.

1. Turn off the power.
2. Hold down the [ENTER] button and the [0] button, and turn on the power.

The microX will be initialized, and the factory preload data will be written into internal memory. While the data is being written, the display will indicate "Now writing into internal memory."

---

## Audio output

### No sound

- Are connections made correctly to your amp, mixer, or headphones?
- Is your amp or mixer turned on?
- Is Local Control turned on?  
In GLOBAL 1: MIDI, check the "Local Control On" check box. ☞PG p.82
- Is the [VOLUME] knob raised? ☞p.12
- If there is no sound from the INDIVIDUAL OUTPUT 1, 2 jacks, make sure that "BUS Select" or "BUS Select" following the insert effect is set to 1, 2, 1/2. ☞p.81
- If specific tracks in Multi mode do not sound, Make sure that the "PLAY/MUTE" is set to **PLAY**. ☞p.70
- Make sure that the "Status" is INT or BTH. ☞p.71
- Are the "Key Zone" and "Velocity Zone" set so that sound will be produced when you play? ☞p.65

### Notes do not stop

- In PROG 1: Ed-Basic, select the Prog Basic page, make sure that the "Hold" check box is unchecked. ☞PG p.6

- In GLOBAL 0: System, Foot page, make sure that “Damper Polarity” or “Foot SW Polarity” is set correctly. [PG p.80](#)

### Noise or oscillation is heard

- When using the BPM/MIDI Sync. function to control the delay time of an effect, noise may occur in the delay sound. This noise is due to discontinuities in the delay sound, and is not a malfunction.
- Some effects, such as 015: St.AnalogRecd, generate noise intentionally. It is also possible to create oscillation using a filter with resonance. These are not malfunctions.

---

## Programs and Combinations

### Settings for oscillator 2 are not displayed

- Make sure that the PROG 1: Ed-Basic, Prog Basic page “Mode (Oscillator Mode)” parameter is set to **Double**.

### A combination does not play correctly after you load data

- Are the bank/numbers of the programs used by the combination the same as when the combination was created?
- If you have switched program banks, you can use the **Change all bank references** menu command to change the program bank for each timbre of a combination. [PG p.77](#)

---

## Multi set

### When you loaded data, a Multi set does not sound correctly

- Are the bank/number of the programs used by the song the same as when the Multi set was created?

### A combination copied using “Copy From Combi” sounds different than it did in Combination mode

- Did you make the correct settings in the Copy From Combination dialog box? [p.72](#)
- In the Copy From Combination dialog box, check the “Auto adjust Arpeggio setting” box before you execute the copy.

---

## Effects

### Effects are not applied

- Are the Effect Global SW **IFX Off**, **MX1 Off**, or **MX2 Off** (GLOBAL 0: System, Basic page) settings checked? [p.87](#)
- If you are in Combination, and Multi mode, and master effects are not applied when you raise the S1(Send1(MFX1)) or S2(Send2(MFX2)) of the timbre/track, does Rtn1(Return 1) or Rtn2(Return 2) from the master effect need to be raised? [p.83](#)  
Alternatively, has **Send 1** or **Send 2** for each oscillator of the program used by the timbre/track been lowered? [p.84](#)

The actual send level is determined by multiplying the send setting of each oscillator in the program with the send setting of the timbre/track.

---

## Arpeggiator

### Arpeggiator does not start

- Is the [ARP ON/OFF] button turned on (lit)?
- If the arpeggiator does not start for a combination or Multi set, make sure that “Arpeggiator Run” is checked, and that an arpeggiator is selected for “Assign.” [p.96](#)
- Is the GLOBAL 1: MIDI “MIDI Clock” parameter set to **Internal**? [PG p.81](#)

---

## Drum Kits

### The drum sample's pitch does not change

- You have left the “Assign” check box unchecked, and want to play the drum sample at the adjacent right a semitone lower, but the pitch does not change.
- If you have selected a drum program in Program mode, and then want to edit the drum kit in Global mode, go to the PROG 2: Ed-Pitch, OSC1 page and set “Pitch Slope” to +1.0 before you enter Global mode.

---

## Audition

### No sound when the [AUDITION] button is turned on

- The Audition function is available only in Program mode.

- If no sound is played when you turn on the [AUDITION] button in Program mode, make sure that the PROG 1: Ed-Basic, Audition page parameter “Audition Riff” has not been turned Off. [PG p.9](#)

---

## MIDI, USB

### This instrument does not respond to incoming MIDI data

- Are all MIDI cables connected correctly? [p.32, 35](#)
- Is the MIDI data being received on the channel on which it is being transmitted? [PG p.81](#)

### This instrument does not respond correctly to incoming MIDI data

- Are the GLOBAL 1: MIDI page MIDI Filter settings “Enable Program Change,” “Bank,” “Combi,” “Ctrl Change,” “AfterT,” and “Exclusive” each **checked**? [PG p.82](#)
- If you wish to receive MIDI exclusive messages, is the GLOBAL 1: MIDI page MIDI Filter “Exclusive” box checked? [p.33](#)
- Does this instrument support the types of messages that are being sent to it?

### When using USB, sound processing is slow, or the tempo is unstable

- Is the MIDI driver installed for the USB port you’ve connected?
  - The driver must be installed for each USB port you use. If you connect the microX to a USB port other than the port you used when installing the KORG USB-MIDI Driver for Windows XP, you’ll need to reinstall the KORG USB-MIDI Driver.
- Have you made the correct “echo back” setting on your computer and the correct Local Control setting on the microX?

---

## Included CD-ROM

### Can’t install the driver included CD-ROM

- Is the USB cable connected correctly?
- Is the CD-ROM inserted in your CD drive?
  - Make sure that the CD-ROM is inserted correctly.
- Could the lens of your CD drive be dirty?
  - Use a commercially-available lens cleaner to clean the lens.

- Are you attempting to install from a network CD drive?
  - This software cannot be installed from a network-connected CD drive.
- Are you able to use USB?
  - If you are using Windows XP, go to [Control Panel] → [System], and select the [Hardware] tab. In [Device Manager], check the settings for Universal Serial Bus Controller and USB Root Hub.
- Has the microX been detected as an unknown device?
  - If you are using Windows XP, go to [Control Panel] → [System], select the [Hardware] tab, and check [Device Manager]. If the microX has not been detected correctly, it will be displayed in “Other devices” or “Unknown devices.” Reconnect the USB cable; if the microX is again displayed as an “Unknown device,” the computer has failed to detect it correctly. Delete the “Unknown device” entry, and reinstall the driver. [p.28](#)

### Your software does not respond to the microX

- Is the USB cable connected correctly?
- Did you install the driver?
- Has your computer detected the connected microX?
  - If you are using Windows XP, go to Control Panel → “Sounds and Audio Devices Properties” and click the Hardware tab.
  - If you are using Mac OS X, go to Macintosh HD → Application folder → Utility folder → “Audio MIDI Settings,” select the “MIDI Devices” tab, and check that the microX has been detected.
  - Some computers may not recognize the microX because of their hardware configuration.
- Check the microX’s assignments and USB-MIDI port settings.
- The connected device or software may not support the messages you are transmitting. See the owner’s manual of the connected device or software to verify that it responds to the messages you are transmitting.

### Software does not operate correctly

- Does your computer meet the operating requirements of the software?
  - Even if your computer meets the requirements, there may be cases in which the software does not operate correctly because of the computer you are using.

# Specifications and options

## Specifications

Operating temperature	+0 – +40 °C (do not allow condensation)
-----------------------	---

<b>System</b>	HI (Hyper Integrated) Synthesis System			
<b>Keyboard</b>	25 key			
<b>Sound Engine</b>	Synthesis types	HI (Hyper Integrated) Synthesis System		
	Maximum polyphony	Single mode	62 voices (62 oscillators)	
		Double mode	31 voices (62 oscillators)	
	Waveform memory	64 Mbyte PCM ROM ( 642 multisamples, 929 drumsamples)		
	<b>Programs</b>	Oscillator	Single = OSC1 only; Double = OSC1 & OSC2 Two-level velocity switching per oscillator	
		Filters	24 dB/octave LPF with resonance, 12 dB/octave LPF + HPF	
		Modulation	Two envelope generators (Filter & Amp), two LFOs, and two key tracking generators (Filter & Amp) for each voice In addition, pitch EG and alternate modulation (AMS) functions	
	<b>Combinations</b>	Number of timbres, master keyboard functionality	Maximum 8 timbres, key and velocity splits/layers/crossfading, Tone Adjust function allows program settings to be modified, control from external MIDI devices	
	<b>Multi sets</b>	Number of tracks, master keyboard functionality	Maximum 16 tracks, key and velocity splits/layers/crossfading, Tone Adjust function allows program settings to be modified, control from external MIDI devices	
	<b>Drum Kits</b>	Drum sample assignments, two-level velocity switching available		
<b>The number of ... -Combinations -Programs -Multi sets -Drum Kits</b>	User combinations	384 combinations/384 preloaded		
	User programs	640 programs/640 preloaded		
	Multi sets	128 multi sets/16 preloaded		
	User Drum Kits	40 Drum Kits/32 preloaded		
	Preset Programs	128 GM preset programs + nine GM2 preset drum programs		
<b>Effects</b>	Insert Effect	1 insert effect (stereo in/out)		
	Master Effects	2 master effects (mono in/stereo out)		
	Master EQ	1 master EQ (3-band stereo)		
	Effect types	89 effect types (available for insert effects or master effects)		
	Modulation	Effect dynamic modulation function (Dmod)		
<b>Arpeggiators</b>	Dual polyphonic arpeggiators	Program mode: one arpeggiator Combination and Multi modes: two arpeggiators		
	Tempo	40–240		
	Number of arpeggio patterns	5 preset, 251 user/251 preloaded		
	Controllers	ON/OFF, REALTIME CONTROLS C-mode knobs [1]–[4]		
<b>Controllers</b>	JOYSTICK, OCTAVE [▼][▲]			
	REALTIME CONTROLS	KNOBS	[1]–[4]	
		SELECT	A, B, C	
	Arpeggiator	ARP ON/OFF		
External control	64 set (1 set = 12 control			
	REALTIME CONTROLS KNOBS [1]–[4], [SELECT] A, B, C			
<b>User Interface</b>	Display	Graphical user interface: 240 x 64 pixel LCD display		
	Mode	Buttons = [COMBI], [PROG], [GLOBAL], [MULTI]		
	Pages	Buttons = [PAGE+][PAGE-], [EXIT], [MENU]		
	VALUE Controllers	Dial = [VALUE], (ClickPoint)		
	VALUE select	ClickPoint [◀][▶][▲][▼] center, Buttons = [OK], [CANCEL]		
	UTILITY	Button = [UTILITY]		
	BANK	Buttons = PROGRAM [A]–[GM], COMBINATION [A]–[C]		
	TEMPO	Knob = PREALTIME CONTROLS C [4]		
	CATEGORY	Buttons = [CATEGORY], ([CATEGORY], PROGRAM [A]–[GM], COMBINATION [A]–[C])		
Other	Buttons = [COMPARE], [AUDITION], Knob = [VOLUME]			



Audio Outputs				
<b>Analog</b>	MAIN OUTPUTS L/MONO, R	1/4" phone jacks (unbalanced); [VOLUME] slider controls only the MAIN OUT L/ MONO and R jacks		
		Output impedance	1.1kΩ stereo (L/MONO is 550Ω for mono)	
	INDIVIDUAL OUTPUTS 1, 2	Maximum Level	L/MONO, R: +12.0 dBu (INDIVIDUAL OUTPUT) 1, 2: +11.6 dBu	
		Load impedance	100 kΩ or greater	
	Headphones	1/8" mini-stereo phone jack; volume controlled by [VOLUME] slider (linked with MAIN OUTPUT L/Mono)		
		Output Impedance	33Ω	
		Maximum Level	36 mW	
		Load impedance	33Ω	
Control Inputs	DAMPER (half-damper supported)			
	ASSIGNABLE SWITCH, ASSIGNABLE PEDAL			
MIDI	IN, OUT			
USB	USB B			
Power	DC power inlet, switch			
Dimensions (W × D × H)	606 × 226 × 80 (mm)			
Weight	2.4 kg			
Power supply voltage	DC 12V			
Power Consumption	10W			
Accessories	AC adapter, Operation guide, CD-ROM (microX Editor/Plug-In Editor, KORG USB-MIDI driver, Parameter guide, External Control Template)			

## Operating requirements for connection to a computer

### KORG USB-MIDI Driver operating requirements

Windows	Computer	A computer with a USB port, that satisfies the requirements of Microsoft Windows XP
	Operating system	Microsoft Windows XP Home Edition, Professional or x64 Edition (The driver for x64 Edition is a Beta version)
Macintosh	Computer	An Apple Macintosh with a USB port that satisfies the requirements of Mac OS X
	Operating system	Mac OS X version 10.3 or later

### microX Editor/Plug-In Editor operating requirements

Windows	Computer	CPU: Pentium III/1 GHz or better Memory: 256 MB or more Monitor: 1,024 × 768 pixels, 16-bit color or better A computer with a USB port, that satisfies the requirements of Microsoft Windows XP
	Operating system	Microsoft Windows XP Home Edition or Professional, Service Pack 1 or later
Macintosh	Computer	CPU: Apple G4/400 MHz or better Memory: 256 MB or more Monitor: 1,024 × 768 pixels, 32,000 colors or better An Apple Macintosh with a USB port that satisfies the requirements of Mac OS X
	Operating system	Mac OS X version 10.3.9 or later

## Options

Expression/volume pedal:	XVP-10 EXP/VOL pedal
Foot controller:	EXP-2
Foot switch:	PS-1
Damper pedal:	DS-1H
Other:	MIDI cable

\* Appearance and specifications of this product are subject to change without notice. (Feb./06)

**microX: MIDI Implementation Chart**

Function	Transmitted	Recognized	Remarks
Basic Channel Default Changed	1 – 16 1 – 16	1 – 16 1 – 16	Memorized
Mode Memorized Messages Altered	X *****	3 X	
Note Number: True Voice	0 – 120 *****	0 – 127 0 – 127	Arpeggiator data can transmit all note numbers 0–127
Velocity Note On Note Off	○ 9n, V=0 – 127 X	○ 9n, V=0 – 127 X	
Aftertouch Polyphonic (Key) Monophonic (Channel)	X ○	○ ○	Transmitted only as ASSIGNABLE PEDAL, *A ASSIGNABLE SWITCH
Pitch Bend	○	○	*C
Control Change	0, 32	○	Bank Select (MSB, LSB)
	1, 2	○	Joystick (+Y, -Y)
	4, 5, 7, 8, 10	○	Pedal, Portamento Time, Volume, IFX pan, Pan
	11, 12, 13	○	Expression, Effect Control 1/2
	64, 65, 66, 67	○	Damper, Portamento Sw., Sostenuto, Soft
	70 – 79	○	Sound (Realtime Controls 1–4A: 74, 71, 79, 72)
	80, 81, 82, 83	○	Switch 1, 2, Foot Switch, Controller
	93, 91, 92, 94, 95	○	Send 1, 2, Effect ON/OFF (IFX, MFX1, MFX2)
	6, 38	○	Data Entry (MSB, LSB)
	96, 97	X	Data Increment, Decrement
98, 99	○	NRPN (LSB, MSB) *C, *2	

100, 101 0 – 95 0 – 101 120, 121	X ○ ○ X	○ ○ X ○	RPN (LSB, MSB) Realtime Controls knobs 1–4 B-assign *C Ext. Control Data (receive *C) All Sound Off, Reset All Controllers *C
Program Change Variable Range	○ 0 – 127 *****	○ 0 – 127 0 – 127	*P
System Exclusive	○	○	*E*4
System Common Song Position Song Select Tune	X ○ 0 – 127 X	○ ○ 0 – 127 X	Corresponds to Arpeggiator reset *1 *1
System Real Time Clock Command	○ X	○ ○	*1 *1
Aux Messages Local On/Off All Notes Off Active Sense Reset	X X ○ X	○ ○ 123 – 127 ○ X	Corresponds to Arpeggiator control *1

Notes

\*P: \*A: \*C: \*E: Transmitted/received when GLOBAL 1: MIDI Filter (Program Change, After Touch, Control Change, Exclusive) is Enable, respectively.  
 \*1: When GLOBAL 1: MIDI Clock is Internal, transmitted but not received. The opposite for Ext-MIDI or Ext-USB.  
 \*2: LSB,MSB=02,00: Arpeggiator ON/OFF, 0A,00: Arpeggiator Gate control, 0B,00: Arpeggiator Velocity control  
 \*3: LSB,MSB=00,00: Pitch bend range, 01,00: Fine tune, 02,00: Coarse tune  
 \*4: In addition to Korg exclusive messages, Inquiry, GM System On, Master Volume, Master Balance, Master Fine Tune, and Master Coarse Tune are supported.

Mode 1: OMNI ON, POLY      Mode 2: OMNI ON, MONO      ○ : Yes  
 Mode 3: OMNI OFF, POLY      Mode 4: OMNI OFF, MONO      X : No

Consult your local Korg distributor for more information on MIDI IMPLEMENTATION.

# Index

## A

- Alternate modulation 51
- Amp 55
- Amp EG 55
- AMS 51
- ARP ON/OFF 91
- Arpeggiator 91
  - Adjusting the tempo 92
  - Link 88
  - On/Off 91, 97
- Arpeggio pattern 93
  - Initialization 99
  - User arpeggio pattern 99
- ASSIGNABLE PEDAL 27, 89
- ASSIGNABLE SWITCH 26, 88
- Assigning a name 114
- Audio output 25
- AUDITION 38
- Audition function 38

## B

- Bank Select 39, 63, 71
- BPM/MIDI Sync. 86
- Bypass 86

## C

- Category
  - Combination 58
  - Name 90
  - Program 38
- Chain 83
- Check box 15
- ClickPoint 13
- Combination 57
  - Bank 58
  - Category 58
  - Select 57
- Combination mode 57
- Compare 47, 63, 74, 99, 108
- Connection 25
  - Computer 27
- Control Track 70
- Convert Position 33

- Copying the settings of a combination (multi set) 72

## D

- DAMPER jack 26
- Damper pedal 26, 41
- Demo song 8
- Detune 67
- Detuned sound 49
- Dialog 15
- Display 15, 119
  - Contrast 115
- Double Program 48
- Drum Kit 50, 107
  - Bank 107
  - Edit 108
  - Effect send 110
- Drum sample 108
- Drums Program 48
- Dual polyphonic arpeggiator 96, 104
- Dynamic modulation 85

## E

- Edit Buffer 118
- Edit cell 15
- Effect 79
- EG 51
- EG-INTENSITY 44
- EG-RELEASE 44
- Envelope Generator 51
- Exclusive 33
- Exclusive Group 109
- External control 111

## F

- Filter 53
  - EG 54
  - Keyboard Track 54
- Fixed Note Mode 103
- Foot pedal 27, 42
- Foot switch 26, 39, 42

## G

- Global mode 87

## H

- Half-Damper 41
- HI (Hyper Integrated) synthesis system 9
- High pass filter 53

## I

- Insert effect 82, 84
- Install
  - Mac OS X 31
  - Windows XP 28

## J

- Joystick 40, 52, 55, 67, 85

## K

- Key Sync. 94

## L

- Layer 64
- LFO 50
- Load 113
- Local Control 32
- Low pass filter 53
- LPF CUTOFF 44

## M

- Master effect 83
- Master EQ 83
- Master keyboard 33
- Memory Protect 88
- MIDI 14, 35, 75, 89
  - Channel 39, 63
  - Data dump 117
  - Filter 64
  - Program change 39, 58, 77
- MIDI channel that will control effects 85
- MIDI/Tempo Sync. 51

- Mode 17
  - Combination mode 57
  - Global mode 87
  - Multi mode 69
  - Program mode 37
  - Select 19
- Modulation
  - Amp 55
  - Filter 54
  - Pitch 52
- Monophony 48
- Multi mode 69
- Multi Mode (Global) 33
- Multi set 69
- Multisample 48
- Multi-timbre 33
- Mute 70
  
- N**
- Note Number 40
  
- O**
- OCTAVE 41, 88
- Oscillator 48
- Oscillator Mode 48, 107
  
- P**
- Page 15
  - Select 19
- Page menu 16
- Pan
  - Drum Kit 110
  - Program 56
  - Timbre 60
  - Track 71
- Parameter 15
  - Select 20
- Performance Edit 43
- Pitch 52
  - Varying the pitch according to keyboard position 52
- Pitch bend 52
- Pitch EG 52
- Polyphony 48
- Portamento 52, 66
- Power 23, 88
- Power On Mode 88
  
- Program 37
  - Bank 38
  - Category 38
  - Select 37
- Program mode 37
  
- R**
- REALTIME CONTROLS 43
  - B-mode 115
- Rename 114
- Resonance 53
- RESONANCE/HPF 44
- Restoring the factory settings 113
- Reverse 49
- Routing 81, 82, 84
  
- S**
- Save 21, 117
  - Combination 61
  - Drum kit 110
  - External control 112
  - Multi set 75
  - Program 45
  - User arpeggio 104
- Scroll bar 16
- Shuffle 95
- Single Program 48
- Slope 65
- Split 64
- Status 63, 71
- Synchronization 105
- System exclusive 33
  
- T**
- Tab 15, 20
- Tap tempo 115
- TEMPO 92
- Tempo Sync. 51
- Text dialog 114
- Three attributes of sound 46
- Tone Adjust 67
- Transpose 33, 67, 87
- Tremolo 55
- Tuning 87
  
- U**
- USB connector 32
- User arpeggio pattern 99
  - Chord 102
  - Drum 102
  - Edit 100
  - Melody 102
- User Scale 89
  - User All Note Scale 89
  - User Octave Scales 89
- Utility 21
  
- V**
- Value 20
- VALUE controller 20
- Velocity 33, 40, 49, 55, 87
- Velocity Switch 64
- Vibrato 52
- Volume 42
  - Timbre 61
  - Track 71
- Volume balance 61
  
- W**
- Wah 54
- Write 21, 117
  - Combination 61
  - Drum kit 110
  - External control 112
  - Multi set 75
  - Program 45
  - User arpeggio 104

### **IMPORTANT NOTICE TO CONSUMERS**

This product has been manufactured according to strict specifications and voltage requirements that are applicable in the country in which it is intended that this product should be used. If you have purchased this product via the internet, through mail order, and/or via a telephone sale, you must verify that this product is intended to be used in the country in which you reside.

**WARNING:** Use of this product in any country other than that for which it is intended could be dangerous and could invalidate the manufacturer's or distributor's warranty. Please also retain your receipt as proof of purchase otherwise your product may be disqualified from the manufacturer's or distributor's warranty.

**KORG** KORG INC.

4015-2 Yanokuchi, Inagi-city, Tokyo 206-0812 Japan