

MBR

KORG MBR

AI SYNTHESIS MODULE

Quick Guide

Features of the M3R

- Compact, occupying only a single rack space.
- Portable, convenient and versatile; use as an external tone generator for sequencing, or as a tone generator for live performance.
- Volume, pan, and other mixer-like functions allow total musical control.
- Two digital multi-effect units are built in, and each unit can use one of 33 types of effects.
- Combine two or more Programs into a Combination for limitless performance possibilities.
- A comprehensive array of drum sounds are built in, making the M3R a perfect choice for any application from making demo tapes to professional performance.



Try it out

First, make sure that the AC cable is correctly connected. Then, connect the MIDI OUT of a sequencer or MIDI keyboard to the MIDI IN of the M3R. To hear the sound, use a mixer-amp system, or listen through headphones.

① When M3R is the only sound source

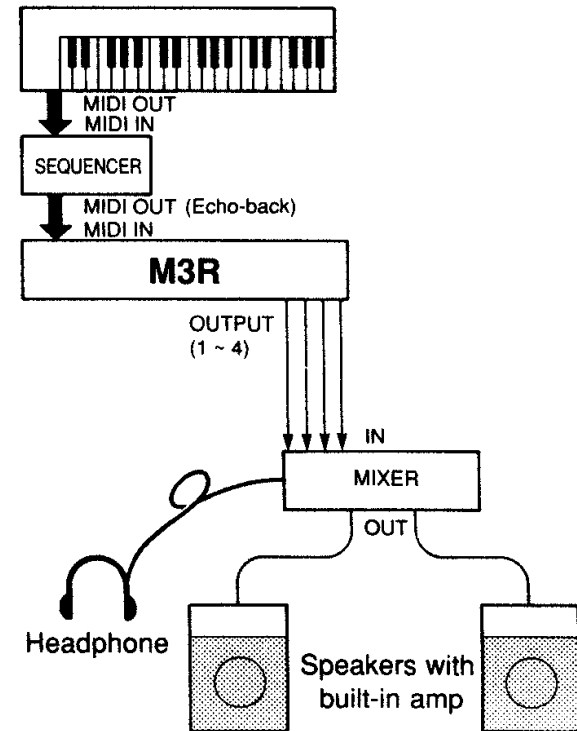

Note: Before you turn the power on, be sure to turn down the volume of your instruments and amp. A sudden loud sound could damage your speaker system.

With the factory settings, the M3R MIDI reception channel (global channel) is set to 1, so make

sure that the MIDI transmission channel of the keyboard or sequencer is also set to 1. To change the MIDI channel settings of the M3R, refer to "Setting the MIDI channel of the M3R" on page 6 of the manual.

② When using an additional sound sources (Rack Mount type)

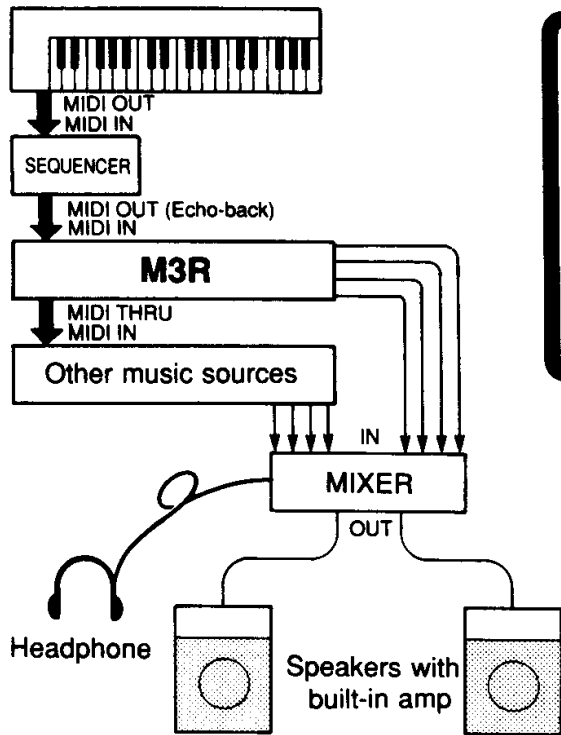

③ When using an additional sound source (Keyboard) I

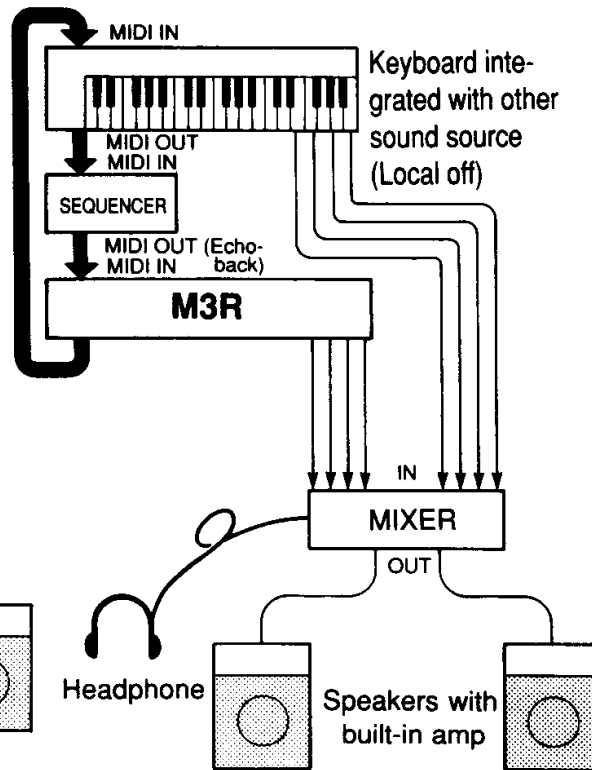

④ When using an additional sound source (Keyboard) II

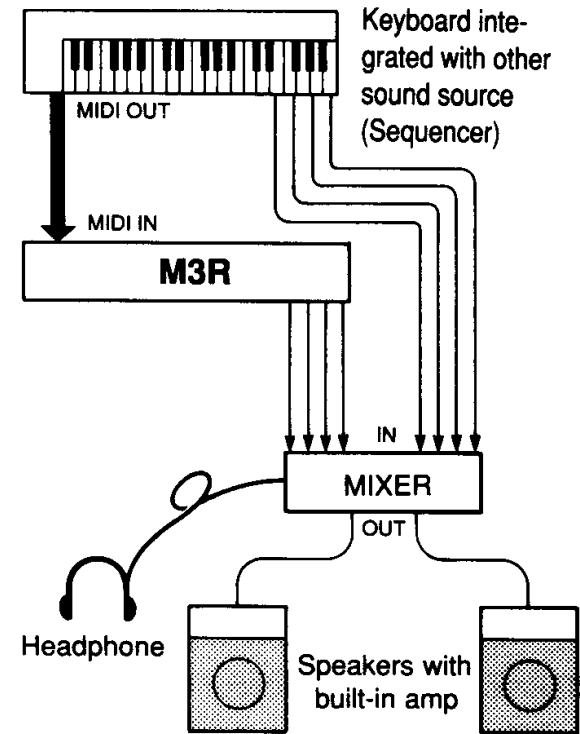

Playing the sounds

Playing a demo performance

The M3R has five built-in demonstration songs. Each song takes advantage of the sounds and functions of the M3R to give you an idea of its possibilities.

1. To hear a demo performance, simultaneously press the PLAY and EDIT keys.

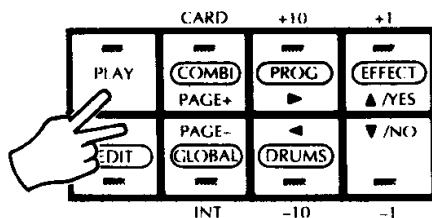

2. Each of the songs are assigned to the five keys other than the PLAY, EDIT, and ∇ /NO keys. Press any one of these keys to start the selected song.

	DEMO 0	DEMO 1	DEMO 2
	DEMO 3	DEMO 4	ENDLSS

3. Pressing ∇ /NO will continuously play all five songs in succession. Press any key to stop playback.
4. Press PLAY or EDIT to return to the previous display.

Note: These songs are in permanent memory (ROM). It is not possible to replace these songs with other data. Remember that modifying the sound data will affect the feeling of the song.

Playing a Combination

The sounds of the M3R are called Combinations. Internal memory contains 100 Combinations, and a card can contain 100 more Combinations. Here's how to select and play a Combination.

1. Press the PLAY key to enter Combination Play mode.

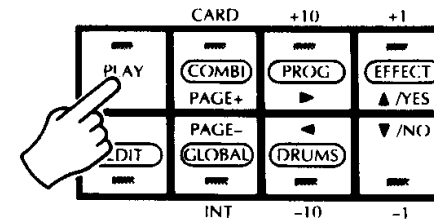

2. Use the +10 / +1 / -10 / -1 keys to select a Combination. The +10 and -10 keys increase or decrease the currently selected Combination number in steps of 10, and the +1 and -1 keys in steps of 1. Combinations in internal memory are numbered from I00 to I99.

PLAY	CARD	+10	+ 1
EDIT	INT	-10	- 1

3. Insert the PROG/DEMO card into the M3R and press CARD to select and play sounds from the card in the same way as from internal memory. Combinations in a card are numbered from C00 to C99.

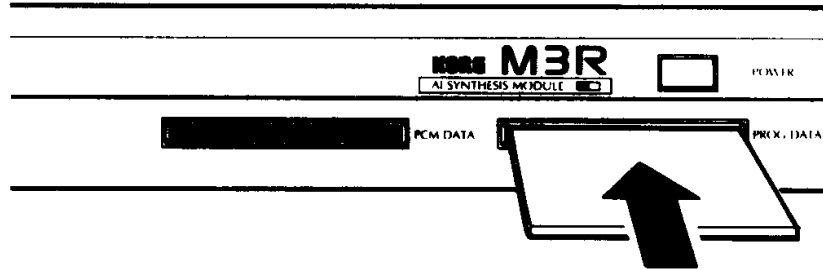

About the M3R's sounds

The sounds of the M3R consist of two levels. The simplest level is the Program, which is a single type of sound. Two or more (or just one) Programs can be combined and played together. This combination of Programs is called a Combination.

COMBINATION

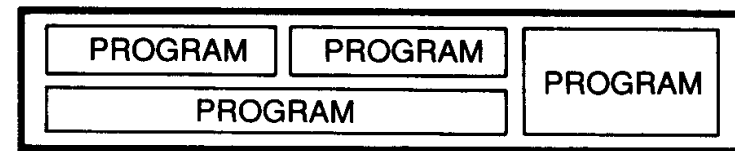

A Program includes various blocks such as the OSC, VDF, VDA and is created by making settings for these blocks and for the pitch EG, VDF EG, VDA EG, Modulation generator, etc.

Programs you create in this way can be combined in five ways (single, layer, split, velocity switch, and multi) to create a Combination.

For example to create a sound by mixing piano and strings, you might use a layer-type Combination to sound a piano Program together with a strings Program.

When creating an entire ensemble by using the M3R as the tone generator for a sequencer, you can use a multi-type Combination and independently control the drums, bass, piano, etc. by setting each instrument (Program) to its own MIDI reception channel.

The basics of M3R sound creation

A setting which affects the sound is called a “parameter”, and modifying its value is known as “editing”. The M3R allows you to create your very own sounds by editing the various parameters.

First we will explain the basic internal organization of the M3R. This will give you an idea of how the M3R produces sound.

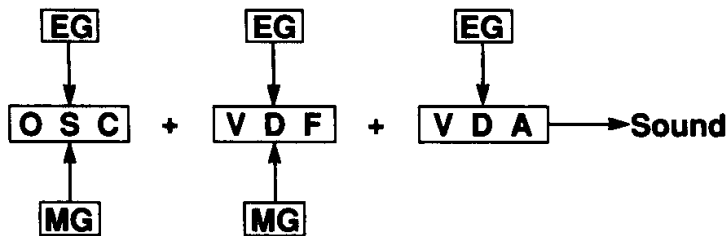

As you can see from the above diagram, the sound-producing process is broadly divided into three blocks. By modifying the parameters that affect each block, you can create a wide variety of sounds. The blocks are labeled OSC (oscillator), VDF (variable digital filter), VDA (variable digital amplifier), EG (envelope generator), and MG (modulation generator).

The first block is the OSC. This determines the basic character of the sound. The EG connected to the OSC is the pitch EG, which dynamically controls the pitch of the sound.

The next block, the VDF, determines the tonal character of the sound produced by the OSC. The VDF filter changes the tone of the OSC sound. For example, vocalizing with your mouth wide open will produce an “aah” type sound. As you gradually close your mouth, the “aah” will change to an “ooh”. The VDF uses digital processing to do approximately the same thing. The EG and MG connected to the VDF determine how the tone changes from the instant the key is pressed to when it is released, or how it cycles through a repeating tonal change.

Finally, the VDA determines the volume. Regardless of the character of a sound, it cannot be heard if its volume is turned down. The VDA causes the volume of a sound to increase when a key is pressed and to decrease when it is released. Adjustments to the VDA will determine how the sound begins and dies away.

These three blocks are the basis of the M3R’s sounds.

The M3R's modes and parameters

The M3R has six "modes". A mode is a group of functions. Grouping the many parameters of the M3R into modes makes it easier to find the parameter you need.

When the power is turned on, the M3R will be in Combination Play mode. The other modes in addition to this are Program Edit mode, Combination Edit mode, Effect mode, Drums mode, and Global mode.

To actually create a sound, you will have to modify different parameters that are located in different pages. In such cases the "page memory" function can remember where you were when you moved to another mode. As you become more familiar with the M3R, you will find that this function saves a lot of time. However to make our explanation simpler, we will turn this function off.

Turning the page memory function off

1. Press the EDIT key. All keys other than the PLAY, EDIT and NO keys will blink.

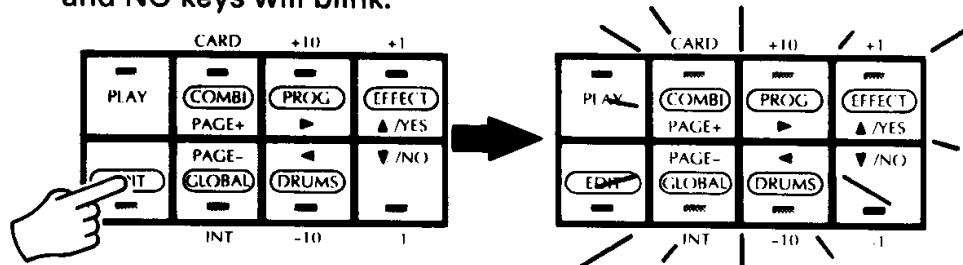

2. Press GLOBAL (PAGE-/INT).

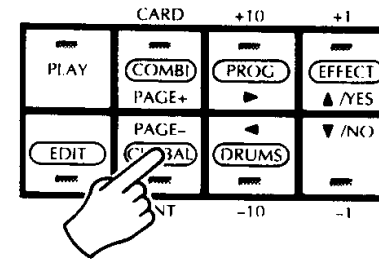

0A TUNE/TRANS
Tune+00 Trans+00

Page 0 of Global mode will appear. The parameters of each mode are grouped in pages. Use the PAGE+ key and PAGE- keys to select pages. The page number is shown in the upper left of the display.

- Press the PAGE+ key three times to select page 3.

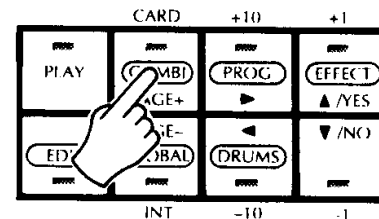

3A PROTECT
PROGRAM: OFF

3. Press the \triangleright key three times to display 3D.

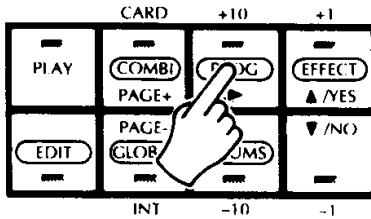

3D PAGE MEMORY ◀
OFF

The OFF display will blink. Blinking data indicates that its value can be changed. Press the \triangle /YES or ∇ /NO keys to make the display alternate between ON and OFF. For now, set the value OFF.

To edit parameters and create your own original sound, you will need to know the meaning of each of the parameters. Here, we will try out various parameters and see how they affect the sound.

To select Program parameters, enter Program Edit mode.

1. Press EDIT. The five keys other than PLAY, EDIT and NO will blink.

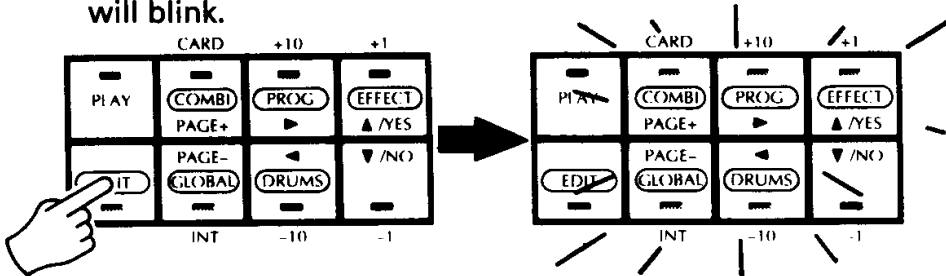

2. Press PROG (\triangleright /+10).

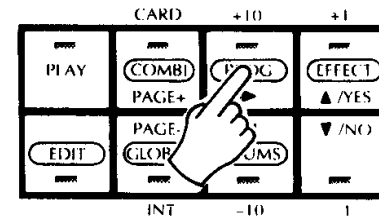

0A PROG SELECT ▶
I06 :Organ 1

This is how you enter Program Edit mode. "I06" indicates Program number 6, which is named "Organ 1". (You can change the name if you want to.) In this display, the Program number blinks alternately with the \triangleright mark, indicating that there is another page 0B to the right side of this display. In this page, use the \triangle /YES and ∇ /NO keys to modify the Program number, and select I06 Organ 1 as shown in this display.

Each page is divided into two to five displays, marked A—E. Use the \triangleleft key and \triangleright key to select these. Page 0 A is now displayed. Press \triangleright to see how the display changes. You will move to the next parameter. if you continue pressing \triangleright , you will move to the end of that page. Press \triangleleft to return.

Using \triangleleft and \triangleright to view parameters or using \triangle /YES or ∇ /NO to modify the data will not affect the internal data.

If you want to keep a Program you especially like, press the ▷ key in page 0A, and use the program writing function of page 0B. The display will be as follows.

OB PROG WRITE ▶
Write→I06 OK?

This function writes a sound you create into M3R internal memory or into a card, so that you can recall it later.

Note: If you execute this writing function, the sound of every Combination that uses this Program will be affected. If you want to preserve the factory settings, save them into a RAM card using the "Save all Program / Combination / Drum data / Global data" function. Or, you can use the "preset data load" function, although this function does not allow you to load individual voices. For details, see the manual sections "Loading from card", "Saving to card", "Formatting a card", "Preset data load" (page 75).

To make this explanation simpler, turn off the effects units using the Global mode function 3C, effect interlock.

1. Press the EDIT key. The five keys other than PLAY, EDIT and NO will blink.
2. Press GLOBAL (PAGE- /INT).

0A TUNE/TRANS ▶
Tune+00 Trans+00

3. Press PAGE+ key three times.

3A PROTECT ▶
PROGRAM: OFF

4. Press ▷ twice.

3C EFFECT ▶
Interlock: OFF

5. If this is ON, press ▽ to turn it OFF.
* If effect interlock is OFF, the headphone output will not include the effect or drum kit sounds assigned to OUT 3 and 4. (Normally 3 and 4 are automatically assigned to 1 and 2.)

Now let's try editing a sound.

OSC

Pages 1 and 2 contain the OSC parameters. Press PAGE+key to select page 1. The display will be as follows.

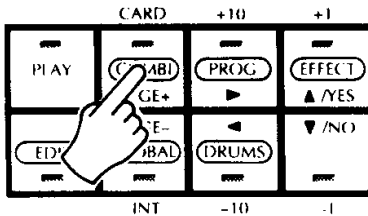

1A OSC M. SOUND ▶
06: Perc. Organ

(If a different display appears, turn the Page Memory function off.) Here we will determine the fundamental character of the sound. Press the Δ /YES or ∇ /NO keys. Various names will appear in the second line of the display. Play the keyboard to hear the sound change. These are the names of PCM sounds built into the M3R.

Next, use Δ /YES and ∇ /NO to select "Perc.Organ" once again, and press \triangleright to move to the next display.

1B OSC ▶
Level 60 OCT16'

The number 60 after LEVEL and the triangular mark in the upper right are blinking. Press \triangleright once again to make the 16' displayed after OCT begin blinking. If you press \triangleright too many times, you will move to the next display, C. If so, press \triangleleft to return to display B.

Use Δ /YES and ∇ /NO to modify the number displayed after OCT, changing the octave over three steps. For this example, leave it at 16'.

Next, press PAGE+key to move to the next page. Page 2 contains the pitch EG parameters. The pitch EG determines how the pitch will change over the time from when the key is pressed to when the key is released and the sound disappears.

2A PITCH EG ▶
SL+00 AT00 AL+00

When this display first appears, the number beside SL will be blinking. Use \triangleleft and \triangleright to make different numbers blink, and use the ∇ and Δ keys to change the value.

Try setting AT (attack time) and AL (attack level) both to values of 30, and press a key. The instant the key is pressed, the pitch will begin rising and then abruptly fall to a steady pitch. Attack time determines the speed at which the pitch will rise, and attack level determines how far the pitch will rise.

SL (start level) determines the pitch level from which the change will begin. Set SL to 30. When you press the

key, the pitch will sound at a higher pitch level than before. Then, at the timing specified by the attack time you set, the pitch will abruptly fall.

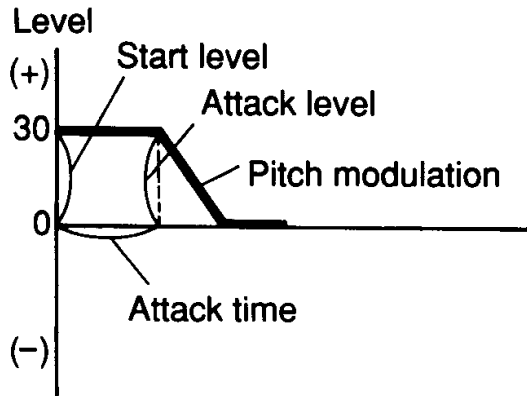

To simulate the slight pitch change that is characteristic of the beginning of brass sounds, set the start level to a negative value and slightly lengthen the attack time. The following display shows an example of this.

```

2A PITCH EG ▶
SL-07 AT16 AL+00
    
```

This adds an interesting nuance to the sound. Now return to page 1, and select some other Multisounds. You will notice that a slight change in pitch at the beginning of each sound makes a big difference in the character of the sound.

For our example, select the Multisound "06:Perc Or-

gan", and set all the pitch EG settings to 00.

The following diagram shows all the parameters of the pitch EG.

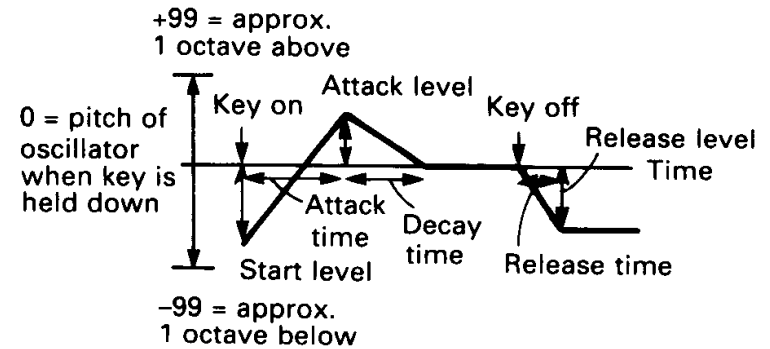

VDF

Pages 3 and 4 contain the VDF parameters. Use the PAGE+ key to select page 3.

```
3A VDF ▶  
Fc61 EGint00
```

Fc indicates the cutoff frequency. As this value is increased the sound will become brighter, and as it is decreased the sound will become darker. For very low settings, you may hear no sound at all. EGint (EG intensity) determines how much the EG (explained later) will affect the value you specified for Fc. Larger settings of EGint will make the sound change more drastically over the time the key is pressed. Use ◀, ▶, ▼ and ▲ to set Fc to 30, and EGint to 50.

```
3A VDF ▶  
Fc30 EGint50
```

The display should look like the above. Press a key, and notice that the sound is a bit darker than before. Changing the EGint setting will not make much difference, since the EG parameters are not set high enough to cause noticeable change. For now, set EGint to 50.

Next we will modify the EG parameters. Use ▶ to get the following display.

```
3B VDF EG ▶  
AT00 AL+00 DT00
```

Set AT to 30 and AL to +80, and press a key. The sound will undergo a two-step change, first becoming gradually brighter and then abruptly darker. If this is difficult to notice, use ◀ to go back to the previous display and increase the EGint setting. The display should appear as follows.

```
3B VDF EG ▶  
AT30 AL+80 DT00
```

The reason for the two-step change is that the decay which follows the attack is too rapid. Try setting DT to about 30, and the change will become slower.

Here is a summary of the parameters of the VDF EG.

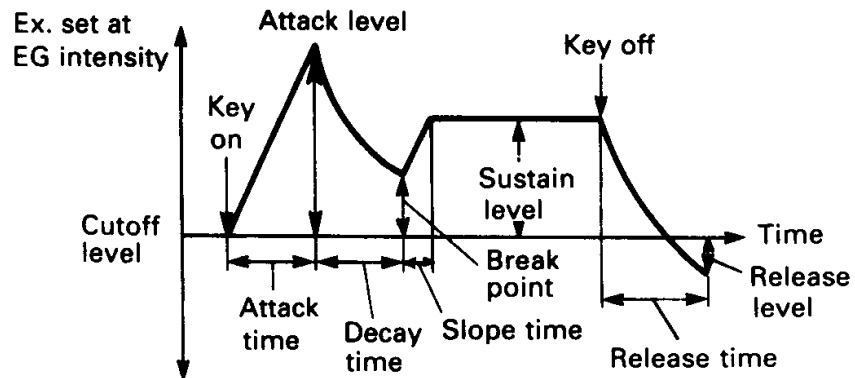

Break point and slope time are parameters which the pitch EG did not have. These parameters allow additional control over the change in sound over time. When the changing level passes the break point level, the slope determined by the decay is interrupted, and moves to the sustain level at the rate determined by the slope time.

When all time changes (timings) are set to 0, the change will be fastest. Settings of 99 will result in the slowest change. Levels can be set to either positive or negative values. For positive settings the sound will become brighter, and for negative settings the sound will become darker.

Page 4 contains parameters for velocity sense and keyboard tracking.

Velocity sense determines how the VDF EG settings we have been looking at will be affected by the force with which a note is played. This allows you to make the sound more musically responsive.

Keyboard tracking determines how the keyboard position (high or low notes) will affect the tone or the EG timing of a voice. This parameter is especially important in simulating acoustic instruments.

VDA

Pages 5 and 6 contain the VDA parameters. Press PAGE+key to select page 5.

```
5A VDA EG ▶
AT00 AL99 DT00
```

The VDA EG determines how the volume will change over the time from when the key is pressed to when it is released. Unlike the VDF EG, the levels of the VDA EG cannot be set to negative values, nor does it have a release level. However, the function of each parameter is the same.

Let's modify some of the parameters to change the sound. Set AT to 30, press ▶ to select the next parameter, and set RT to 30.

```
5C VDA EG ◀
RT30
```

The VDA is simply changing the volume over time, but this has a major effect on the character of the sound.

MG

The EG affects the sound according to a single, fixed “envelope” (shape) which runs from beginning to end for each note and does not repeat. However it is also possible to make the sound change in a continuously repeating pattern, and this is the job of the modulation generator (MG). Page 7 contains the modulation generator parameters.

Using the MG to affect the OSC will result in vibrato. Use the PAGE+key to select page 7B.

```
7B PITCH MG ▶
Int00 K. Sync:OFF
```

Int determines the intensity of the modulation effect. Try setting this to 30. The change in pitch will be so intense that the note will no longer have a definite pitch. For a more natural vibrato effect, set the intensity to about 10. For another important pitch MG parameter, press ◀ to return to page 7A.

```
7A PITCH MG ▶
TRI Frq68 Dly00
```

The Dly parameter determines the delay from when the key is pressed to when the vibrato begins. This is currently set to 00, and vibrato will begin as soon as a key is pressed.

Set this to about 20, and notice the time delay before vibrato begins.

The TRI displayed at the far left stands for “triangle waveform”. Use △ ▽ to select various waveforms and listen to the different results.

The speed of the vibrato is determined by the Frq (frequency) parameter.

Page 8 contains parameters that determine how pressing down on the keyboard after playing a note will affect pitch, VDF or VDA parameters (aftertouch).

Parameters in page 9 determine the function of the pitch bender and modulation wheel (bend / sweep).

When creating a sound, it is important to utilize the interaction between the parameters of each block, and to have a clear idea of how editing each parameter will affect the overall sound. Especially important are the EGs used in each block. Understanding the effect produced by each of the EGs may be difficult since the nuances of timing are dynamically changing, but is one of the major aspects of creating a good sound. Experiment with various parameter settings, and listen to the results for yourself.

Writing a sound into memory

Now that you have edited parameters to make an original sound, here's how to store it in the M3R internal memory or in a memory card. To store, you must first turn off the program memory protect.

1. Press EDIT, and the five keys other than PLAY, EDIT and NO will blink.
2. Press GLOBAL to enter Global mode.
3. Press the PAGE+ key three times to select page 3A.

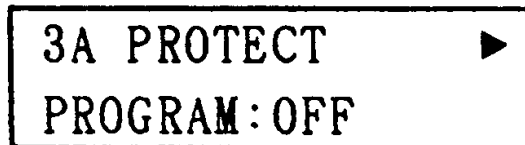

A rectangular display box with a black border. The top line shows "3A PROTECT" followed by a right-pointing arrowhead. The bottom line shows "PROGRAM: OFF".

4. If the area that displays OFF in the above display is set to ALL, it will not be possible to write data into any memory. (This function is provided to help you avoid accidentally erasing important data.) Use the ∇ key to set this to OFF, so that you will be able to write data into internal memory or into a card.

This turns off program memory protect. Next, enter Program Edit mode once again, and execute the program write job of page 0B. This will overwrite the previous data. You may want to save the internal data to a card or an external data storage device before writing. (These functions can be found in Global mode pages 5B and 4A. For details, refer to the manual.)

In this example, we will rename the sound before storing it.

1. Press EDIT, and the five keys other than PLAY, EDIT, and NO will blink.
2. Press PROG to enter Program Edit mode.
3. Press \triangleright to get the 0C display.

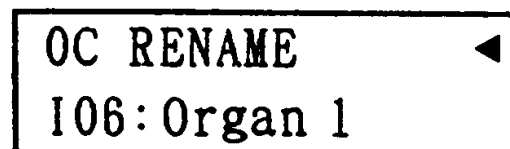

A rectangular display box with a black border. The top line shows "0C RENAME" followed by a left-pointing arrowhead. The bottom line shows "I06: Organ 1".

The first character of the name ("O") should be blinking alternately with the cursor. Pressing the \triangleleft or \triangleright keys will move the cursor, and \triangle /YES or ∇ /NO will modify the selected character. Use these keys to enter a name, and then press \triangleleft to get the 0B display.

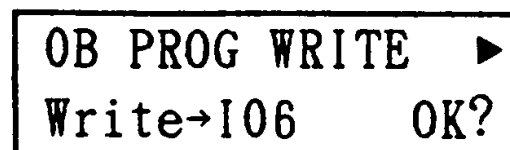

A rectangular display box with a black border. The top line shows "0B PROG WRITE" followed by a right-pointing arrowhead. The bottom line shows "Write to I06" followed by "OK?".

4. The OK? will be blinking. Press \triangleleft and the I06 beside Write will blink. This specifies that the data will be written into internal memory I06. You can use the \triangle ∇ keys to modify this.
5. Press \triangleright to make the OK? blink, and press \triangle /YES to get the following display.



A rectangular display box with a black border. The top line shows "0B PROG WRITE" followed by a right-pointing arrowhead. The bottom line shows "Are You Sure OK?".

Press Δ /YES to write the data into memory.

6. When the data has been correctly written into memory, the following display will appear.

```
OB PROG WRITE  ►  
Completed
```

Press any key to continue to your next operation.

What is a Combination?

As we have already mentioned, the sounds of the M3R are organized in two levels. First is the "Program". Next, one or more Programs are organized into a Combination. There are five ways to combine Programs into a Combination; single, layer, split, velocity switch, and multi. Each Combination uses one of these five combination types.

This may be easier to understand if you imagine a tray which contains several glasses of juice. Each glass represents a Timbre, and there can be up to eight of these. The juice represents a Program; a single type of sound. The arrangement of glasses is the combination type, and the entire tray represents the sound-producing capability of the M3R.

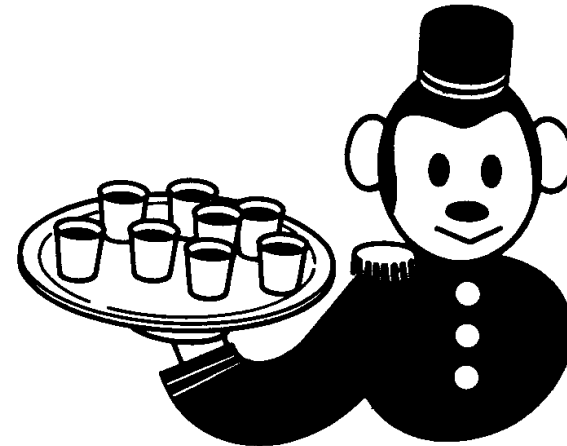

Single

Of the five combination types, this is the simplest. It is a Combination which consists of just a single Program. This combination type allows you to use the largest possible number of simultaneous notes.

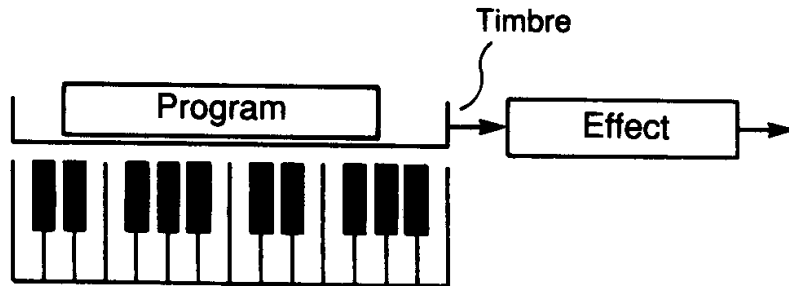

Layer

This combination type will play two Programs for each note.

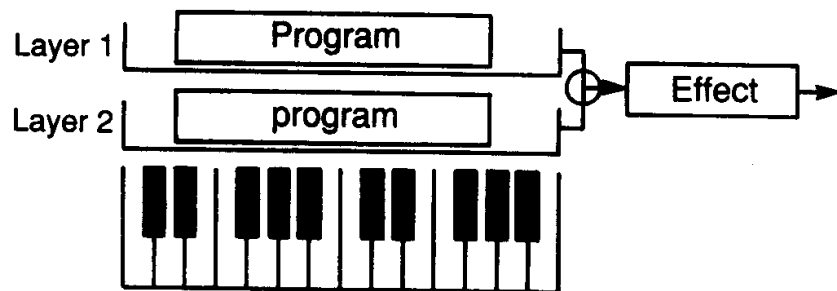

Split

This combination type will play two Programs, each from different areas of the keyboard.

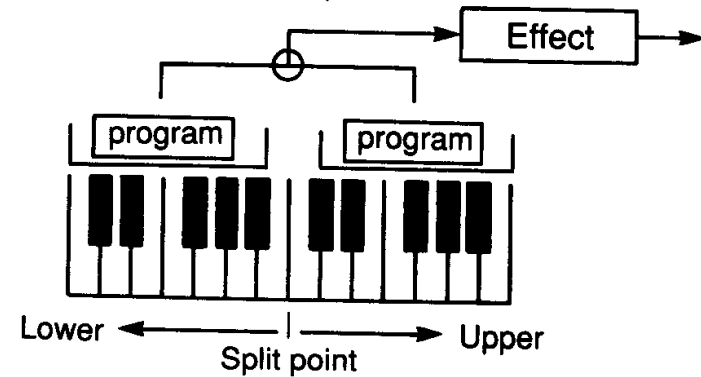

Velocity switch

This combination type plays one of two Programs, depending on how hard you play a note (i.e., key velocity).

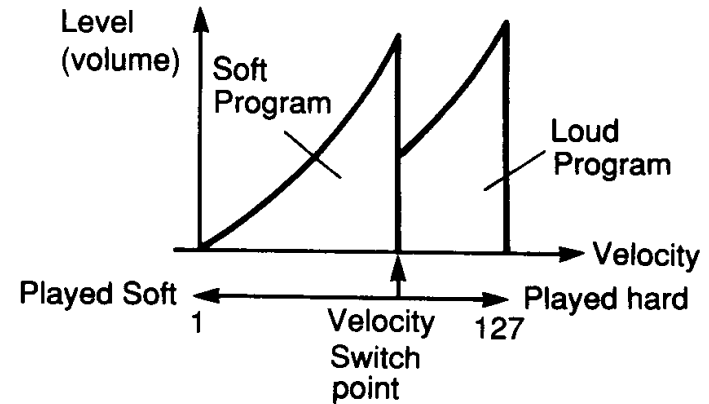

Multi

This combination type can use up to eight Timbres, and allows you to specify a MIDI channel, note range, and velocity range that will be received by each Timbre. This is especially effective when using the M3R with an external sequencer to produce the sound of an entire ensemble.

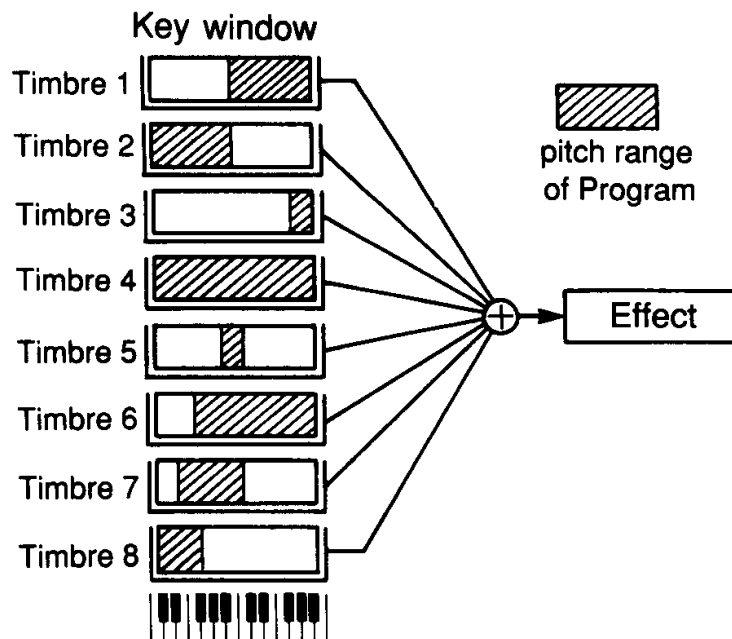

Creating a Combination

Here's how to create a new Combination.

1. Press EDIT, and the five keys other than PLAY, EDIT, and NO will blink.
2. Press COMBI (PAGE+ / CARD).

```
0A COMB SELECT ▶  
100 :Krypton
```

This enters Combination edit mode. The display of 100 indicates that internal Combination number 00 is selected, and that the Combination name is "Krypton". (Of course you can change this as you like.) As shown, the ▶ mark and the Combination number will be blinking alternately, indicating that page 0B also exists.

Use △ /YES and ▽ /NO to specify the number of the Combination you will be creating. In this example, select 100 Krypton as shown in the display.

If you want to keep the Combination you are modifying, press ▶ in page 0B just as you did to write a Program into memory.

```
0B COMB WRITE ▶  
Write>100 OK?
```

We will be explaining the details of this function later.

Note: If you modify parameters and write the modified data into memory, the sound of the Combination will be affected. If you want to keep the sounds of the factory settings, use the "Save all Program / Combination / Drum data / Global data" function to save the data to a RAM card. Or, you can use the "preset data load" function, although this function does not allow you to load individual sounds. For details, see the manual sections "Loading from card", "Saving to card", "Formatting a card", and "Preset data load" (page 75).

Specify the Combination Type

Now we will select the appropriate combination type for the Combination we are creating. Press the PAGE+ key to move to page 1A.

```
1A TYPE SELECT
MULTI      OK?
```

The MULTI display should be blinking. As with other parameters, use the Δ /YES and ∇ /NO keys to select the type. After setting the type, press \triangleright to make the OK? display blink. Now press Δ /YES. Unless you do this, the modified combination type will be restored to its previous setting when you move to another page.

Single

Set the combination type of page 1A to Single.

```
1A TYPE SELECT
SINGLE     OK?
```

Single is the most basic type of Combination. It has the fewest number of parameters — the three parameters of Program number, level, and panpot. This type allows you to play a Program just as it is, using the maximum possible number of simultaneous notes and using the effects units to add character to the sound.

Press the PAGE+ key to move to page 2. The number blinking at the left is the Program number I29 Clicker. This will produce a clicking sound regardless of which key you play. Use the Δ /YES ∇ /NO keys to set the Program number to I06 Organ 1.

```
2A SINGLE
I06:Organ 1
```

Press PAGE+key to move to the next page. Page 3 is where you set level and panpot. Usually, you will set the level so that volumes will remain consistent as you select different Combinations. In this example we will set this to 99.

Panpot determines the output of the sound. The M3R produces sound using a Program, combines these sounds

as a Combination, and finally outputs the sound through the effects units to the four output jacks. Outputs A, B, C, and D do not indicate the final sound outputs, but are the inputs to the two effects devices. You can specify that A, B, C, and D are all used as independent inputs, or turn A and B stereo on and adjust the A:B balance, or specify C+D so that C and D are used in stereo. When using A and B in stereo, the balance of right and left will be displayed. For a setting of 5:5, channels A and B will have the same volume, and the sound will be located in the center of the stereo field. For a setting of 9:1, the sound will be located towards channel A, and for a setting of 1:9, towards channel B. In this example we will set panpot to 5:5.

3A SINGLE
Level=99 Pan=5:5

Layer

Layer is a combination type which plays two Programs when each key is pressed. This does not simply give you two single programs, but allows you to specify a different damper pedal setting for each, and also the tuning of each Program. In this example, we will be trying out a layer Combination which plays two Programs of the same sound but with a slight delay to create a richer sound.

First, we will create a Program with a timing delay. Enter Program Edit mode, and select Program I08 Guitar

1. Next, we will move to page 0B and write this program into memory. Change the Program number to I09, press \triangleright to make the OK? blink, and press \triangle /YES to write the Program into memory. What we have just done is to copy the same Program as I08 into I09. To avoid confusion, refer to page 00 "Writing a Program" and rename the newly copied I09 to "Guitar D".

Next we will delay the timing of the newly copied Program. In page 1E, use \triangle /YES ∇ /NO to edit the OSC delay value. In this example, we will use a setting of 30.

1E OSC
Delay=30

Next, use page 0B to write the Program into memory. We will not change the Program number, but will write it into memory I09 which we are now editing.

This completes our preparations. Now we are ready to create our layered Combination. Move to Combination Edit mode, and in page 1A set the combination type to Layer.

1A TYPE SELECT
LAYER OK?

If you now move to another page, the newly selected combination type will be returned to its previous setting. To prevent this, press \triangle /YES to answer the blinking OK?.

Press the PAGE+ key to select page 2, and use Δ /YES ∇ / NO to select a Program for layer 1. In this example we will select I08 Guitar 1.

2A LAYER 1 \blacktriangleright
I08:Guitar 1

Press \blacktriangleright to move to page 2B which contains the settings for layer 1 volume and panpot.

2B LAYER 1 \blacktriangleright
Level=99 Pan=5:5

In this example, set level to 99 and panpot to 5:5 as shown in the above display.

Next press \blacktriangleright to move to page 2C. Here you can turn the damper pedal on/off for layer 1. When this is set to DIS, the damper pedal will be disabled for layer 1, and will not affect the Program. In this example, set it to ENA so that the damper pedal will function.

2C LAYER 1 \blacktriangleleft
Damper=ENA

Next we will specify the Program for layer 2. Use the page keys to select 3A, and select Program number I09 Guitar D.

3A LAYER 2 \blacktriangleright
I09:E. Guitar D

Press \blacktriangleright to move to the 3B display, and make settings for level 99 and panpot 5:5 as you did for layer 1.

3B LAYER 2 \blacktriangleright
Level=99 Pan=5:5

Layer 1 does not have the pitch interval and detune parameters of Layer 2 (3C).

3C LAYER 2 \blacktriangleright
INT=+00 Tune=+00

Pitch interval and tune are both parameters which specify the pitch of layer 2 in relation to the pitch of layer 1. Pitch interval is in units of a chromatic step, and tune is in units of a cent. For this example, set tune to +10.

3C LAYER 2 \blacktriangleright
INT=+00 Tune=+10

As for layer 1, set the 3D damper setting to ENA.

3D LAYER 2 ◀
Damper=ENA

Play the keyboard, and notice that the sound is richer than when you played the sound as a single-type Combination. Experiment with different settings of page 3C detune, or try setting the interval to +12 (one octave) for additional variations.

Split

Set the page 1A combination type to Split.

1A TYPE SELECT ▶
SPLIT OK?

Next press PAGE+key to select 2A. This parameter specifies which key will divide the two sounds. Notes above this note will play the upper Program, and notes at or below this note will play the lower Program.

2A SPLIT
Point=C4

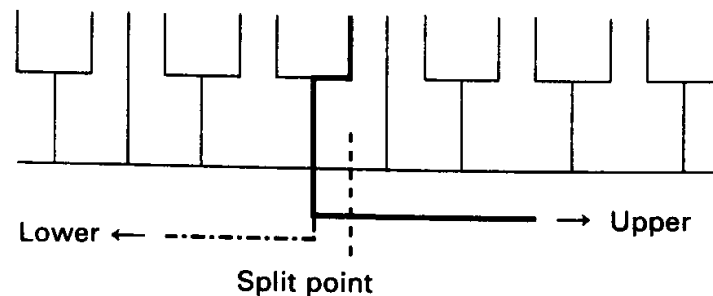

Program number, level, panpot, and damper pedal for the upper and lower Programs are set in pages 3 and 4. If you give the upper Program a damper setting of DIS, only the lower Program will be sustained while you press the damper pedal, for interesting performance possibilities.

Velocity Switch

Set the page 1A combination type to Velocity Switch.

1A TYPE SELECT ▶
VEL. SW OK?

Next press the PAGE+ key to select 2A. Notes played more strongly than the velocity you specify here will play the Loud program, and notes played more softly will play the Soft program.

2A VEL. SW
Point= 060

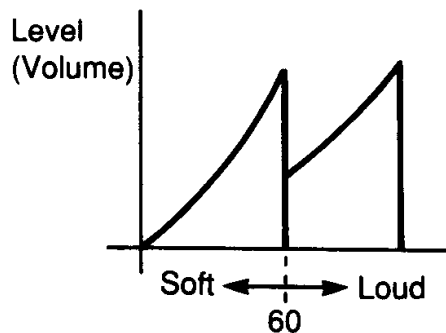

Example:
a velocity switch
point setting of 60

Program number, level, panpot, and damper pedal for the soft and loud Programs are set in pages 3 and 4.

Multi

This combination type is especially useful when controlling the M3R from a sequencer, but can also be used to create complex Combinations that would not be possible using the other combination types.

For example when using a layer-type Combination with different Programs for each layer, incoming program change messages will select the same Program for both layers since they share the same MIDI channel. In such cases, you could use a multi-type Combination, and use the page 8 A—D MIDI parameters to set program change reception Off.

Or if you want to create a velocity switching Combination using two or more velocity switch points, make the appropriate settings for the velocity window parameters of page 6 A—D.

In the same way, you could create a split Combination using two or more split points by making the appropriate settings for the key windows.

For details, refer to the manual.

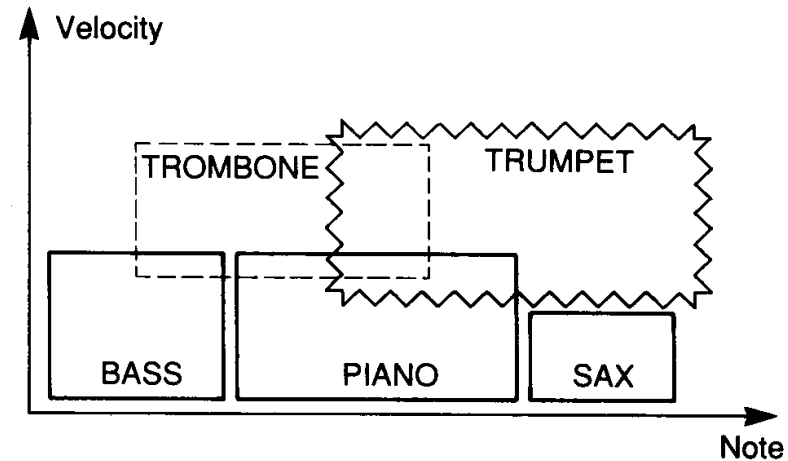

Writing a Combination

In the same way as Programs, a Combination you have created in this way can be written into M3R internal memory or into a card for later use. In order to write data, the combination memory protect must be turned off.

1. As when turning off program memory protect, enter Global mode.
2. Use the PAGE+key and ▷ keys to select display 3B.

```
3B PROTECT ▶  
COMBINATION:OFF
```

3. Use △ ▽ to turn combination memory protect Off. This turns combination memory protect off. Return to Combination Edit mode and use the combination write operation of page 0B. Remember that this operation will replace the Combination that was previously in that memory. You may want to save internal data to a card before writing. (This can be done in Global mode pages 5A and 4A. For details, refer to the M3R manual.)

In our example, let's rename the Combination before writing it into memory.

1. Enter Combination Edit mode.

2. Press ▷ to select the 0C display.

```
0C RENAME ◀  
I00:Krypton
```

The "K" should be blinking alternately with the cursor. Pressing the ◀ or ▷ keys will move this blinking cursor. Use the △ /YES ▽ /NO keys to modify the blinking character, and enter a Combination name. When finished, press ◀ to select the 0B display. The display will blink OK?

```
0B COMB WRITE ▶  
Write→I00 OK?
```

3. Press ◀ and the value beside Write will blink. This specifies the internal memory into which we will write the data. If desired, use the △ ▽ keys to change this.
4. Press ▷ to make OK? blink, and press △ /YES to get the following display.

```
0B COMB WRITE ▶  
Are You Sure OK?
```

Press △ /YES again.

5. When the data has been correctly written into memory, the following display will appear.

OB COMB WRITE ►
Completed

Press any key to continue to your next operation.

Adding effect settings

(1) The Program determines the finished sound including effect settings, (2) the Combination combines several sounds together, and (3) the Effects device adds the finishing touches. The M3R has two built-in stereo digital multi-effects devices.

There are 12 basic types of effect; reverb, early reflection, delay, chorus, flanger, phase shifter, tremolo, equalizer, overdrive, exciter, ensemble, and rotary speaker. Each type of effect has several variations, making a total of 33 types of effect. Detailed parameter settings can be made for each effects unit.

Effect settings are stored as part of each Combination, meaning that two or more single-type Combinations that use the same Program could have different effects settings, and thus sound quite different. Being able to make effect settings for each sound means that you have complete control over the final sound that the listener will hear. These two stereo digital multi-effects devices can produce different effects for left and right channels, meaning that they can also be used as up to four effects devices (monaural).

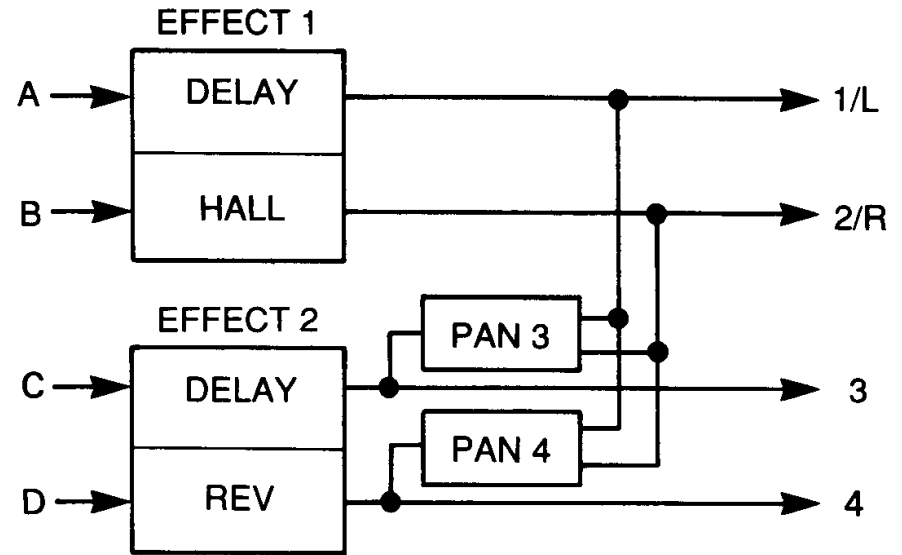

The two effect devices can also be connected in two different ways, providing additional possibilities.

Turning the effect on/off

Now let's hear what these effects actually sound like. To keep things clearer, we will turn one of the two effects devices off. Press the EDIT key, then press the EFFECT key to enter Effect Edit mode. If the effect is OFF as shown in the following display, press \triangleright to make the OFF display blink, and press \triangle /YES to turn it ON.

```
0A EFFECT1=01  ►
Hall           ON
```

Press PAGE+key to select page 4A.

```
4A PLACEMENT  ►
Parallel
```

Use \triangle /YES ∇ /NO to set this to Serial. Next, use the PAGE-key to select page 2.

```
2A EFFECT2=01  ►
Hall           OFF
```

If this is OFF, leave the setting as it is. If it is ON, press \triangleright to make the ON display blink, and press ∇ /NO to turn it OFF.

Reverb

Reverberation depends on many factors, such as wall materials and the size of the room. Reverb simulates the reverberation that naturally occurs in any acoustic environment.

It is necessary to add artificial reverb to simulate the reverberation that is always present when acoustic instruments are played. Reverb can not only simulate natural reverberation, but can also create reverberation which could not exist in nature.

Reverb is divided into six types according to its basic character; hall, ensemble hall, concert hall, room, large room, and live stage. These are essentially classifications of room size, and will affect the length of the reverberation. Select page 0A.

```
0A EFFECT1=01  ►
Hall           ON
```

The number after EFFECT 1= is blinking. Use \triangle ∇ to modify this number. Numbers 1 through 6 are reverb. Reverb has four main parameters; reverb time, high damp, predelay, and early reflection level. Other additional parameters are equalizer and dry / effect balance.

Equalizer settings boost or cut the high or low frequency portions of the reverb to affect its overall character.

Dry / effect balance determines the balance of the unprocessed sound and the reverb. In this example, set this to 50:50 so that you will be able to hear the effect more easily.

Reverb time is the time over which the reverb will decay. Higher settings will result in longer reverb.

High damp determines how the high frequency portion of the reverb will decay. If the walls are covered with a soft material such as curtains, the high frequencies will be absorbed more easily, and decay more quickly. However in a garage, for example, where the walls are made of a hard material such as concrete, the high frequencies will not be absorbed but will continue reverberating. In general, the high frequency content of reverb will be less for distant sounds. Use ◀ ▶ to select parameters, and use △ /YES ▽ /NO to try out different values.

Early reflection

Early reflections are the first acoustic reflections that reach our ears after the direct sound, but before the reflections merge into an unbroken “wash” of reverb. The early reflection effect extracts these first reflections from the rest of the reverberation, and is a very important factor in simulating a natural acoustic environment. There are three variations to this effect, and each allows you to set two main parameters; early reflection time and pre delay.

Early reflection time determines how the early reflections will decay. Use ◀ and ▶ to select parameters, and △ /YES ▽ /NO to try out different values.

This is especially good for adding an effect of gated reverb to percussive sounds such as drums. In particular, early reflection III gives a reverse envelope to the early reflections, resulting in an effect similar to a reversed tape when applied to a sound with a strong attack.

Delay / Chorus / Flanger

These three effects each have two variations. Each effect has its own distinct character, but operates in a similar way. Essentially, they delay the incoming sound and output a mixture of this delayed sound with the direct sound. The time delay and the mixing determine the character of the effect.

<Delay>

This is a simply an echo effect, with two variations; delay and cross delay. The main parameters are left and right delay times, feedback, and high damp.

Feedback determines the number of times which the delay will repeat. Higher settings will cause more repeats. High damp determines how the high frequencies of the repeated sound will decay. Higher settings will cause quicker decay.

The cross delay effect makes the delayed sound alternate from left to right. This will be most effective when heard through headphones.

<Chorus>

The Chorus effect uses a shorter delay time than the delay effect, and no feedback. The specified delay time is modulated, creating a continuous change in pitch. By combining this with the original sound, a feeling of natural spaciousness is created.

The main parameters of this effect are modulation depth, modulation speed, and delay time. Use ◀ and ▶ to select parameters, and △ /YES ▽ /NO to try out different values. By setting modulation depth and speed to high values, you can create unique effects in which the sound will begin to be heard as an unpitched sound.

<Flanger>

The Flanger effect uses an even shorter delay time than the Chorus effect, with feedback. By mixing the delayed sound with the original sound, the two sounds are made to partially cancel, creating an effect of strongly applied filtering. For sufficiently long delay times, feedback determines the number of repeats, but for the short delay times used by the flanger, feedback acts like a resonance control for the filter. Raising the feedback level can make the filter begin oscillating, and cause a feeling of pitch to be given to the sound.

As with chorus, the other main parameters of this effect (in addition to feedback) are modulation depth, modulation speed, and delay time. This effect has a very strong character, but it can be skillfully used to give a sound personality.

Phase shifter

As with chorus and flanger, the phase shifter effect also uses modulation to give a swirling character to the sound, but the effect is less obvious and more refined. This effect is created not by mixing a delayed sound with the original sound, but by mixing in a sound that has had its phase modified.

Phase refers to the point at which a sound waveform begins. Human ears are not able to detect differences in phase, so as long as the sound wave has the same shape and frequency, it is heard as the exact same sound regardless of where the wave began.

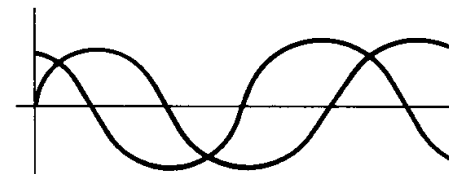

By mixing this with the original sound, a filtering effect results, and we hear the sound as being modulated.

The main parameters for this effect are manual feedback, modulation depth, and modulation speed.

Tremolo

Unlike effects such as delay, chorus, flanger, and phase shifter which directly modify the tonal character of the sound, tremolo cyclically modifies the volume of the sound.

This is often used in stereo to make the sound shift from right to left. The main parameters for this effect are the same as for the modulation-type effects; modulation depth and modulation speed. High settings of these parameters will result in the most extreme effect.

Equalizer

This is a two-band equalizer, with control over high and low frequencies.

Overdrive

This includes two variations; overdrive and distortion.

Each type distorts the sound. Overdrive is the effect made famous by electric guitarists. Distortion is a rougher effect than overdrive.

Either of these effects is useful in thickening single notes, and is effective for solos. When used on chords, the sound will become rather muddy.

Exciter

This effect boosts the high frequencies to make the sound stand out more clearly and give it brilliance. When you feel that your sound somehow lacks sparkle, using this effect can add the necessary presence.

Ensemble

This is a multiple version of the chorus-type effect, and is especially effective when used on strings to add richness and natural spaciousness.

Rotary speaker

This effect simulates the rotary speaker often found on electric organs. In an attempt to add richness and depth to the sound, early electric organ speakers contained a mechanism which used a motor to physically rotate the speaker, producing an effect of vibrato and dispersing the sound more evenly around the room. This soon became an inseparable part of what we consider to be the sound of an electric organ.

As might be expected from its historical development, this effect is especially suited for organ sounds.

Looking inside a Drum Kit

The M3R contains a drum sound generator as well. You can select any 30 of the 45 percussion sounds provided, and freely assign these sounds over the keyboard to create your own Drum Kit. Internal memory can contain four of these Drum Kits. Each sound has its own parameters for level, tune, decay, and pan.

Press EDIT. The five keys other than the PLAY, EDIT, and NO keys will blink. Press DRUMS (< / -10).

```
0A DRUM1 #00 ▶  
---:No Assign
```

* Select a Drum Kit in Program mode before you enter Drums mode. Sometimes, the drum sounds may sound a bit different. If the OUT 3, 4 setting for the effect of the currently selected Combination is OFF, drums panned to C and D will not be heard.

In Drums mode, the page number increased by 1 will correspond to the Drum Kit number. In this example we will edit the Drum Kit which appears first; Drum Kit 1.

The "#00" which is blinking at first is known as the "index".

There are 30 of these indexes, and a sound can be assigned to each index. Use Δ /YES ∇ /NO to move through the indexes. You will see that a different sound is assigned to each index. Here we will select an index of "#08".

```
0A DRUM1 #08 ▶  
08:TOM
```

In this display, the sound "TOM 1" has been assigned. Use \triangleright to make the instrument display blink, and use Δ /YES ∇ /NO to modify the sound assigned to this index. If you specify "—:No Assign", this index will not be used. For our example, use Δ /YES ∇ /NO to select "TOM 1" for this index.

Press \triangleright to select 0B. This contains three parameters; key, tune, and level.

```
0B KEY/TUNE/L ▶  
D3 T+000 L+00
```

When the key specified by "key" is played, the sound assigned to this index will be produced. (If a drum sound has already been assigned below this key, all keys from the following key to the currently assigned key will produce the same sound. The pitch will change in chromatic steps.)

The "Tune" setting modifies the tuning. Use \triangleright to make this value blink, and use Δ /YES ∇ /NO to modify it while continuing to play the specified key. The tuning of the sound will change over a range of ± 1 octave.

Level adjusts the volume. Use \triangleright to make this value blink, and use Δ /YES ∇ /NO to modify the level. For a

setting of +00, the volume will be as specified by the OSC level. (This does not mean that there will be no sound.) Negative settings will decrease the volume below the value specified by the Program.

OC DECAY/PAN ◀
Decay+00 Pan=5:5

OC contains settings for decay, output, and panpot. Decay determines how the sound fades to silence. Low settings of this value will make the sound decay more sharply.

You can specify panpot as A, B, C, or D independently, or use AB as stereo and adjust the A:B balance, or specify C + D to use C and D as stereo.

As with the panpot in Combination Edit mode, the four outputs A, B, C, and D are not the final outputs for the sound, but are the inputs to the effects devices.

Global mode

Global mode contains the parameters which affect the entire M3R. In addition to overall pitch and key transpose, scale selection, and MIDI channel settings, this mode contains functions for transferring data to and from ROM and RAM cards.

Press EDIT, and the five keys other than PLAY, EDIT, and NO will blink. Then press GLOBAL (PAGE-/INT).

0A TUNE/TRANS
Tune+00 Trans+00

The Tune parameter is a fine tuning adjustment for the entire M3R. Use this when you need to tune the M3R with the other instruments in your band. The range is ± 50 in steps of one cent. Since one cent is 1/100th of a chromatic step, this allows you to adjust the pitch up or down as much as a half of a chromatic step.

Key transpose allows you to adjust the overall pitch in chromatic steps, up to 1 octave up or down.

Press the PAGE+ key to get the 1A display. These parameters select the scale (temperament). Unless an acoustic piano is tuned regularly, it gradually drifts out of tune until it begins to sound bad. But on electronic instruments, individual pitches never go out of tune, and never need to be tuned.

However, the M3R allows you to select from five

different tunings; equal temperament, random pitch, pure major, pure minor, and a user-defined scale. These different tunings are especially important when chords are played.

Most keyboard instruments are tuned in equal temperament. When playing in equal temperament, you can freely transpose keys, since chords will sound exactly alike in all keys of equal temperament.

Equal temperament random pitch is the same as equal temperament, but with a slight random pitch variation for each note you play. This is effective when simulating instruments whose pitch has natural instability, such as guitar or brass.

Press the PAGE+ key. This page contains MIDI-related settings.

2A MIDI GLOBAL ►
CH= 1 OVFL:OFF

CH=1 is the setting for the M3R's basic MIDI channel. If your keyboard (or sequencer) is transmitting on a different channel than this, M3R multi-type Combinations will sound only the Programs whose channel matches the channel transmitted by the keyboard.

OVFL is the overflow switch. This is used when two M3Rs are connected via MIDI. Normally you will leave this set Off.

2B and 2C contain MIDI message filter settings.

2B MIDI FILTER ▶
PRG:ENA AFT:ENA

2C MIDI FILTER ◀
CTRL:ENA EX:DIS

Normally, the M3R receives all incoming MIDI messages that it is capable of responding to. These filter settings allow you to specify the types of message that will be ignored. 2B contains the filters for Combination program changes and aftertouch. 2C contains the filters for control change and exclusive messages. A setting of DIS means that the corresponding type of messages will be ignored, and will not be transmitted by the M3R.

CONTENTS

Features of the M3R	2
Try it out	2
Playing the sounds	4
About the M3R's sounds	5
The basics of M3R sound creation	6
The M3R's modes and parameters	7
Now let's try editing a sound	10
Writing a sound into memory	15
What is a Combination?	16
Adding effect settings	26
Looking inside a Drum Kit	31
Global mode	33

KORG[®] KORG INC.

15-12, Shimotakaido 1-chome, Suginami-ku, Tokyo, Japan.

1991 ©KORG INC.

0308 CTH *Printed in Japan*