

# TABLE OF CONTENTS

Front panel .....	2
Rear panel .....	3
<b>INTRODUCTION TO THE KORG M3R .....</b>	<b>4</b>
<b>BASIC OPERATION .....</b>	<b>6</b>
Setup .....	6
How to play combinations (Groups of voices) .....	7
How to play programs (Individual voices) .....	7
How to hear a demo song .....	7
Sound creation procedure .....	8
Modes and key functions .....	10
About the display .....	12
Effect interlock function .....	13
Page memory function .....	13
How the M3R is organized .....	14
Memory in the M3R .....	14
<b>MODES AND FUNCTIONS .....</b>	<b>15</b>
How to read a display page chart .....	15
1. Program edit mode .....	16
2. Combination play mode .....	28
3. Combination edit mode .....	31
4. Effect mode .....	48
5. Drums mode .....	69
6. Global mode .....	73
<b>CONNECTION TO THE RE1 .....</b>	<b>79</b>
Connections .....	79
RE1 operation .....	79
The display .....	80
<b>MIDI EXCLUSIVE .....</b>	<b>86</b>
<b>ERROR MESSAGES .....</b>	<b>96</b>
<b>SPECIFICATIONS AND OPTIONS .....</b>	<b>96</b>
<b>TROUBLESHOOTING .....</b>	<b>97</b>
<b>MIDI Implementation Chart .....</b>	<b>98</b>
Multisound List	
Drum Sound List	

# FRONT PANEL

Page 11 explains the function of each key.

- ① **MASTER VOLUME**
- ② **PHONES jack**  
A set of stereo headphones can be connected here to monitor OUTPUT1/L and 2/R.
- ③ **Display**
- ④ **MODE/MIDI indicators**  
These light when MIDI data is received.
- ⑤ **PLAY key**
- ⑥ **COMBI, CARD, PAGE + key**
- ⑦ **PROG, +10 key, ▷ key**
- ⑧ **EFFECT, +1, △/YES key**
- ⑨ **EDIT key**
- ⑩ **GLOBAL, INT, PAGE key**
- ⑪ **DRUMS, -10, ◀ key**
- ⑫ **-1, ▽/NO key**
- ⑬ **PCM data slot**  
Cards containing PCM (Multisound, Drum sound) data can be inserted here. Do not insert Program cards into this slot.
- ⑭ **PROG/DEMO data slot**  
Cards containing Program data (or into which you will be storing Program data) can be inserted here. Do not insert PCM (Multisound) cards into this slot.
- ⑮ **POWER Switch**

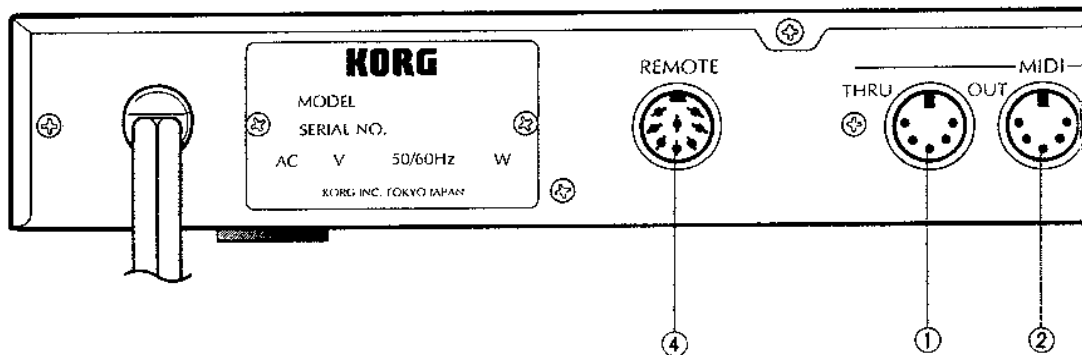
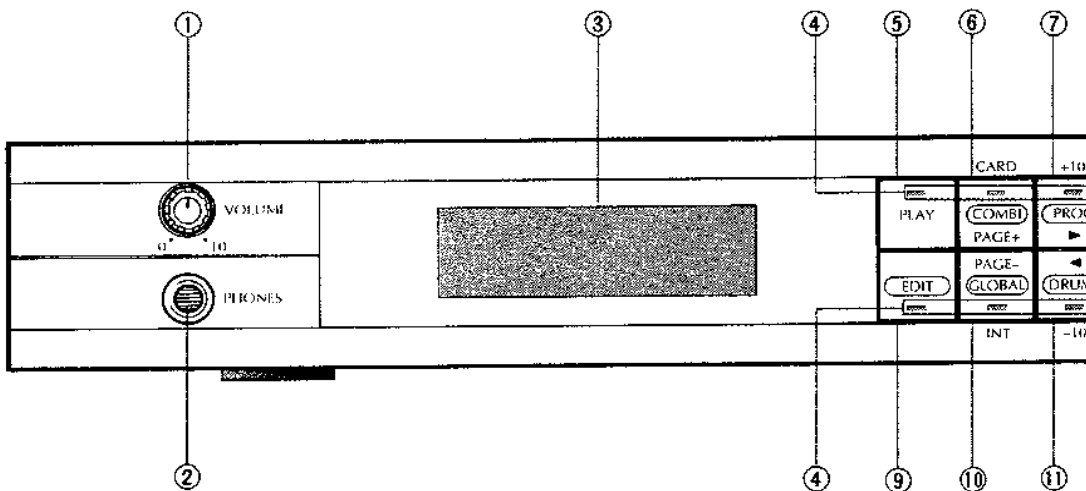

# REAR PANEL

- ① MIDI THRU jack
- ② MIDI OUT jack
- ③ MIDI IN jack
- ④ REMOTE jack

An RE1 remote editor can be connected to this jack.

- ⑤ OUTPUT jacks (1/L, 2/R, 3, 4)

These are the audio outputs of the M3R. Various parameters determine how voices are assigned to each output jack.

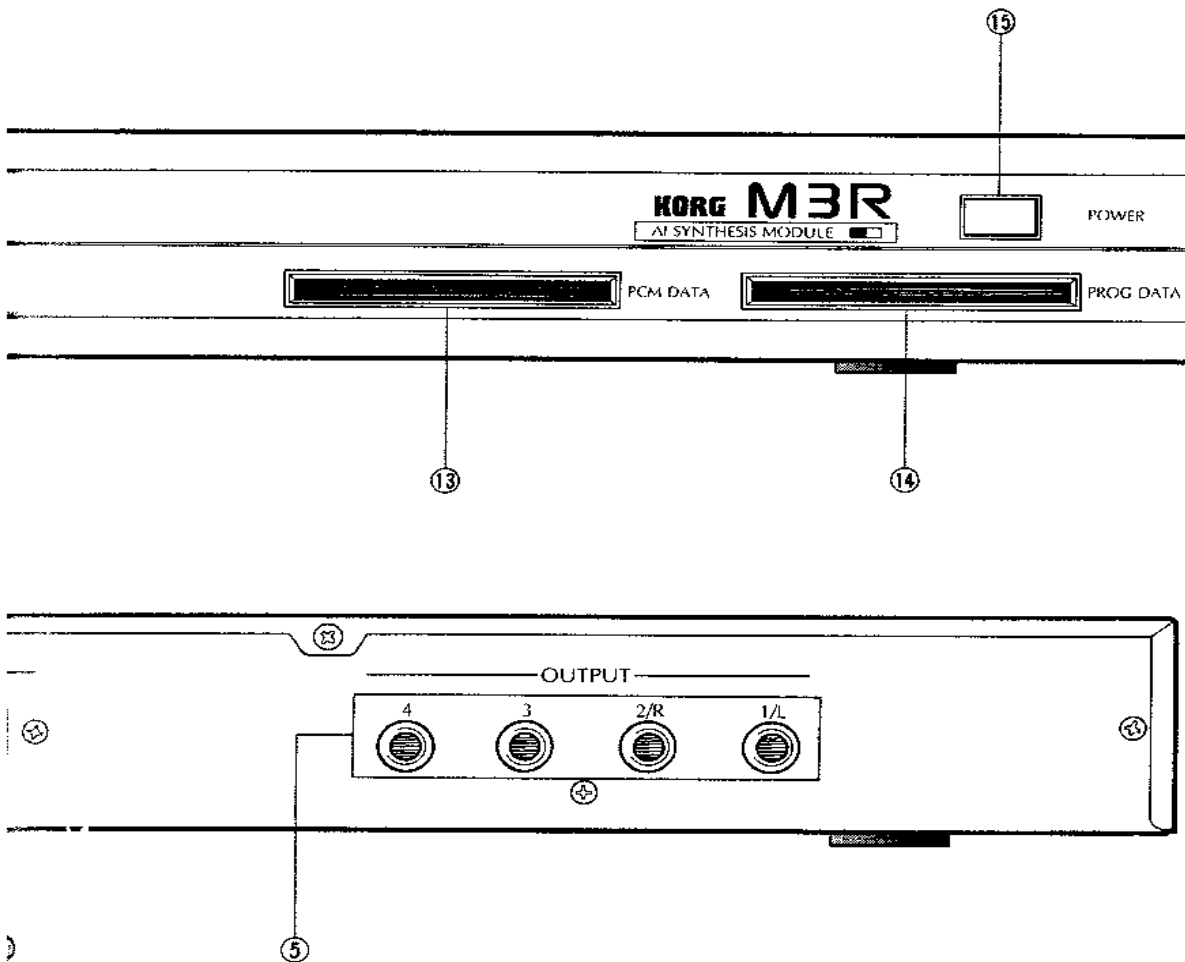

# INTRODUCTION TO THE KORG M3R

The Korg M3R is a module employing the principles of AI Synthesis to give you stunningly clear bright sounds to add to your MIDI system. It is more than just a "synthesizer without a keyboard", since it also provides a full range of percussion sounds and a complete range of digital effects.

## MIDI connections

As the M3R is a rack-mountable module with no controls for playing notes, you will need to connect a MIDI keyboard to the M3R using a MIDI cable from the OUT of the keyboard to the IN of the M3R. If you wish to take full advantage of the multi-timbral capabilities of the M3R, you will need to connect a sequencer as well. The usual way of doing this is:

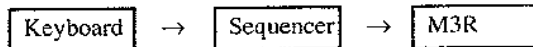

using a "THRU" or "ECHO" function on the sequencer. If you are in doubt, consult your local MIDI guru (usually your music store). The MIDI THRU connection on the back of the M3R is used for "daisy-chaining" other MIDI devices from the M3R, and the MIDI OUT is used for the M3R's "Overflow" function or transmitting System Exclusive messages (don't worry about these just yet).

## Audio connections

There are four audio output connections on the back panel. Any sound produced by the M3R may be assigned to any one of these outputs, A, B, C or D. In addition, a sound may be assigned to any position between A and B, meaning that if these two outputs are connected to two input channels of a mixer, one panned hard left and one panned hard right, the sound may be placed anywhere in the stereo image. As a further option, a sound may be assigned to be output from C and D equally. This flexibility, combined with the integral effects units, greatly reduces the number of input channels required on a mixer.

## Other connections

There is one other connection on the back of the M3R, labelled "REMOTE". This is for the RE1 remote editor, which provides a larger display and more controls than are found on the front panel of the M3R. Though all editing and program selection can be carried out from the front panel of the M3R, there are times when you may not be close enough to the unit to carry out editing operations, or you may feel the need to see

and control more parameters than are visible on the M3R's own display. The RE1, then, while not an essential accessory, is certainly an option you should consider if you intend to do a lot of editing work on the M3R. Note that there are no footswitch or other controller input sockets. This is because the M3R is designed to be controlled remotely from another MIDI device, and all performance controls are transmitted via MIDI from these devices.

The only other connections are a headphone socket on the front panel, by the volume control (which affects both headphone volume and the overall volume of the outputs on the back panel), and two card slots. These can hold Korg memory cards - the PCM DATA slot holding Multisound waveform data on ROM (Read-Only Memory) cards, and the PROG DATA slot holding your own edited data on RAM (you can write to them and read from them) cards. Of course, the M3R has its own internal memory, so these slots do not have to be used - but they are a convenient way of expanding the capabilities of the M3R and storing your work.

## Synthesizer sound production - a little history

In older analog synthesizers, the heart of the sound-generation section was a bank of one or more voltage-controlled oscillators (VCOs) which produced a simple waveform such as a sine wave, sawtooth or square wave. These waveforms were mixed together and fed through a voltage-controlled filter (VCF) which modified the basic sounds produced from the VCOs to produce a richer, less "mechanical" sound. The amount of filter applied to the basic VCO sound was controllable with regard to time using an Envelope Generator (EG), so a note could, for instance, be filtered sharply at the beginning of a note, and less towards the end, producing a "wow" or "wah" effect. The amount of filtering, pitch and volume could also be controlled by a low-frequency oscillator (LFO), sometimes called a modulation generator (MG), (resulting in vibrato, tremolo, and "wah-wah") before the sound was sent through an EG to the voltage-controlled amplifier (VCA). The EG enabled you to vary the attack and decay times, the sustain level and release time of a sound. Some analog synthesizers had more features than this, others may have had slightly fewer, but the principle was the same in all cases.

---

## Synthesizer sound production - up-to-date with the M3R

---

You'll be relieved to know that the M3R uses exactly the same principles as the analog synthesizers described above. Of course, since the M3R uses newer technology, there are bound to be a few differences. Here they are.

Firstly, the "oscillators" in the M3R are called "Multisounds". This is because they are not simple sine-, triangle- or square-wave oscillators, but digitally-recorded and created complex waveforms simulating real acoustic instruments. However, if you feel the need for "vintage" synth sounds, the M3R provides you with Multisounds containing the older sine, sawtooth and square waveforms as well. The pitch is controlled by the note played from the controlling keyboard, as well as by other factors, such as the MG and by an EG.

Next, the filters and amplifiers. Since the M3R has its own microprocessor "brain", capable of controlling digital devices, these filters and amplifiers are digitally-controlled. In the M3R they are called VDFs and VDAs (Variable Digital Filter, Variable Digital Amplifier). These are much more reliable and stable than their voltage-controlled equivalents, while providing the same level of flexibility and sound quality. Both the filters and amplifiers can be controlled by EGs as well as by the note played on the keyboard and by an MG.

Older synthesizers had very few expressive controls available to the player - usually a pitch bend control and a device for increasing the amount of modulation. Only expensive synthesizers featured velocity sensitivity and a very few featured aftertouch. (Velocity sensitivity refers to the speed or force with which a key is initially struck, and aftertouch refers to the pressure exerted on a key after it has been struck.) These controllers, as well as some others which vary from machine to machine are now much more common (microprocessors again!), and the M3R is fully equipped to make use of these to modify the sound as you wish.

In addition to these synthesizer voices (or "Programs"), the M3R can also use special kinds of programs called "Drum Kits". In these programs, Multisounds are not used, but each MIDI note is assigned to a different drum sound (taken from the M3R's internal memory). With a Drum Kit, you cannot alter so many parameters as with other types of program, but you can still customize the sounds to make your own personal settings.

The M3R can play 16 notes at a time (including drums). These do not all have to be the same program, as these are combined into (logically enough) "Combinations". Up to eight different programs may be assigned to a Combination in various ways. It is possible to play one program at a time, two programs together, arrange things so that one program plays when a key is hit softly, and another when the same key is played hard, or so that different programs are played by different parts of the keyboard. Different programs may also be selected on different MIDI channels (multi-timbral capability), which is especially useful for work with a sequencer.

---

## Effects

---

The effects rack of a recording studio used to be a large space filled with bulky, difficult-to-use equipment, which was expensive! Once again, microprocessors have come to the rescue and digital effects which used to be completely out of the price range of smaller studios and individual musicians are now commonplace. The M3R includes two such built-in digital effects units. These effects units can be used as part of a combination to modify the basic program sounds by adding reverb, echo, chorus, flange, delay, etc. There's even a rotary speaker simulation for organ sounds. These effects are not preset types, but allow you as much control as you would expect on a stand-alone digital effects unit.

# BASIC OPERATION

## SETUP

- (1) Make sure that the power of all MIDI devices and other equipment (amps, mixers, etc.) connected to the M3R is turned off. Turn the volume of all equipment completely down.
- (2) Connect the power cable to an AC outlet. Connect the power cables of your other equipment and MIDI devices.
- (3) Turn the M3R power on.
- (4) After turning the power of the other connected devices on, raise the volume of the M3R and other devices to an appropriate volume level. Unless the MIDI channel of the M3R matches the MIDI channel of your other MIDI equipment, there will be no sound when you play the MIDI keyboard. To set MIDI channels, refer to the following section below "Set the MIDI channel to match the keyboard"

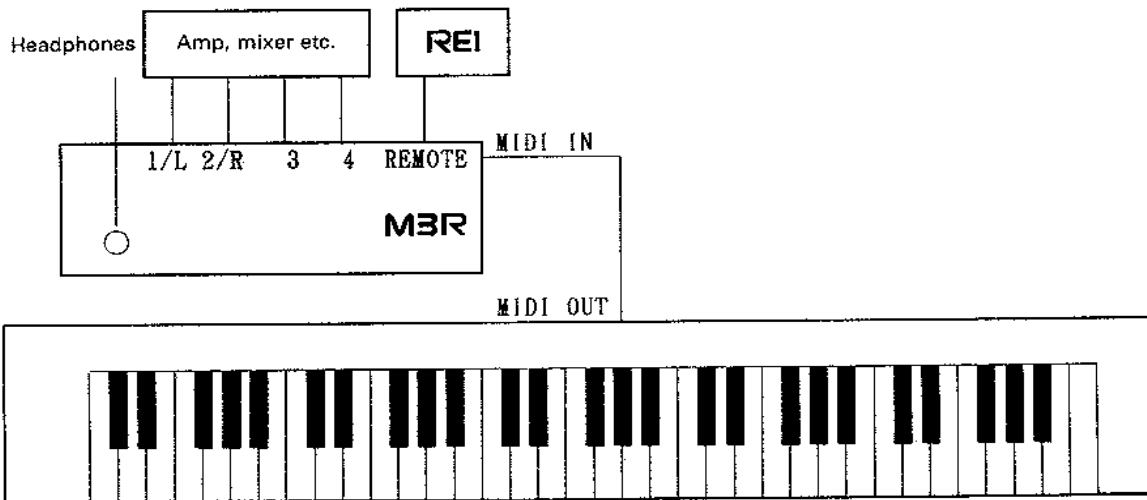

- All notes C-1 – G9 (note numbers 0–127) received at MIDI IN will be sounded. (Some programs may not sound when played in higher ranges.)

Key name	C-1	C0	C1	C2	C3	C4	C5	C6	C7	C8	C9	G9
Note number	0	12	24	36	48	60	72	84	96	108	120	127

### Set the MIDI channel to match the keyboard

- (1) While holding the EDIT key, press the GLOBAL key.
- (2) Press the PAGE + key twice.
- (3) Check that the blinking area is located at "CH= \_ ". If it is at a different location, continue pressing the ◀ key.
- (4) Press △/YES and ▽/NO to select the desired MIDI channel.
  - In combination mode when the Type is Multi, MIDI data of other channels will be received in addition to the channel set here.
  - For some Combinations, there may be no sound even though the GLOBAL MIDI channel matches.

## HOW TO PLAY COMBINATIONS (GROUPS OF VOICES)

- (1) Press the PLAY key. (COMBINATION PLAY mode)

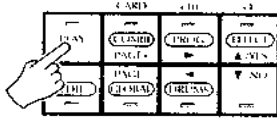

- (2) Use the +10/+1/-10/-1 keys to select the Combination you want to play (00-99).

PLAY	CARD	+10	+1
EDIT	INT	-10	-1

100 Krypton  
 129 174 135 127

- (3) Play the keyboard to hear the selected Combination.  
(When a multi-type Combination is selected, only the sounds which match its MIDI channel will be heard.)

- \* You can insert a PROG/DEMO card and press the CARD (COMBI/PAGE+) key to play card voices.

## HOW TO PLAY PROGRAMS (INDIVIDUAL VOICES)

- (1) Press the EDIT key followed by the COMBI key (COMBINATION EDIT mode)

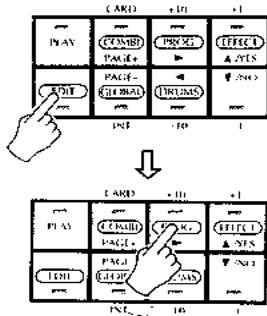

- (2) Press the PAGE+ key so that "1A TYPE SELECT" is displayed at the top of the screen and the cursor is on the Combination Type parameter (either MULTI, VEL.SW, SPLIT, LAYER, or SINGLE is displayed and flashing). If this is not displayed, use the PAGE+ and < and > keys so that this display appears.

- (3) Use the -1/NO key to select SINGLE and then move the cursor to the OK? field using the > key. Confirm by pressing +1/YES. The SINGLE field will begin flashing again.

- (4) Now press the PAGE+ key so that "2A SINGLE" is displayed at the top of the screen, and a voice number (eg "184" is flashing). Use the 1/YES and -1/NO keys to select the Program to be played (00-99).

- \* The effect will not be applied. (When effect interlock is Off.) \* If a PROG/DEMO card is inserted, you can press CARD and select sounds from the card as well.

PLAY	PAGE+	>	1/YES
EDIT	PAGE-	<	-1/NO

- (5) Now play the selected program from your keyboard.

0A PROG SELECT  
 100 :Piano 16'

## HOW TO HEAR A DEMO SONG

- (1) Simultaneously press the PLAY and EDIT keys.



- (2) The memory contains five demo songs, with a song number corresponding to each key. If you press ∇/NO, songs 1-5 will continue playing endlessly. If songs are played individually, playback will stop at the end of the song.

	DEMO 0	DEMO 1	DEMO 2
	DEMO 3	DEMO 4	ENDBLSS

- (3) Press the PLAY or EDIT key to return to the previous display. To exit, press any key.

- If a ROM card containing demo data is inserted into the PROG DATA slot, the demo from that card will play.
- During demo playback, data is not transmitted from display.

SONG0: LadyAmazon

**Note:**

Making changes in sound-related data will affect the playback of the songs.

# SOUND CREATION PROCEDURE

**1** Select a sound to be the basic element of your new sound (use the Oscillator parameter).

- The basic element of a sound is called a Multisound (tone generator waveform).
- An Oscillator (OSC) is the basic sound-source of a synthesizer.

**2** In PROGRAM EDIT mode, modify the Multisound you selected in step 1.

- Use the VDF (Variable Digital Filter) to modify the tone. This can be used to make the tone softer, or to make the tone change over time. For example this could be used to make a sound be bright when first played, become softer as you continue holding the key, and then become bright again when you release the key.
- Use the VDA (Variable Digital Amplifier) to modify volume. This can be used to make the volume change over time. For example, a violin can be made to begin sounding gradually as you continue to hold a key down, and an organ can be made to sound continuously as long as a key is depressed.

- Sounds created in this way are called Programs. The M3R can store 100 Programs (00-99). Programs in internal memory can also be stored on a card.

**3** In COMBINATION EDIT mode, combine the programs you created in step 2.

- In the first page of COMBINATION EDIT mode, select the COMBI NO. to use.
- Next select the COMBINATION TYPE.
- When LAYER is selected, two programs will sound when a single key is pressed.
- When SPLIT is selected, the right and left areas of the keyboard will play different programs.
- When VELOCITY SWITCH is selected different programs will sound depending on how strongly you play.
- When MULTI is selected, up to 8 programs can be freely combined as using Layer, Split, and Velocity Switch. Since a different MIDI channel can be assigned for each timbre (an instrument to which a program is assigned), select MULTI mode when using the M3R as a multi-timbral tone generator for a sequencer.
- When SINGLE is selected, only one program will be played in this combination.

■ Assign the internal drum tone generators to each key in DRUMS mode.

- Pressing a note will play a drum sound.
- This is also where you make settings for pan (the position of the sound in the stereo mix) and pitch.
- An assignment of up to 30 drum sounds is called a Drum Kit.
- A single M3R can remember 4 different drum kits.
- In the same way as for Multisounds, drum kits can be selected as oscillators. This allows you to use PROGRAM EDIT and COMBINATION EDIT to modify the sound of a drum kit.

☆ Example

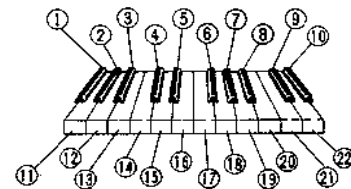

1 BASS DRUM 1	8 HAND CLAPS	15 CLOSED HI HAT
2 SNARE 1	9 HI CONGA (MUTED)	16 PICCOLO SNARE 1
3 HI TOM	10 LO BONGO	17 PICCOLO SNARE 2
4 CLOSED HI HAT	11 BASS DRUM 2	18 CRASH CYMBAL 2
5 OPEN HI HAT	12 SNARE 2	19 RIDE CYMBAL 2
6 CRASH CYMBAL 1	13 MID TOM	20 HI CONGA (OPEN)
7 RIDE CYMBAL 1	14 LO TOM	21 LO CONGA (MUTED)
		22 HI BONGO

☆ Layer/Velocity Switch

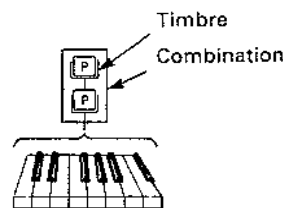

☆ Split

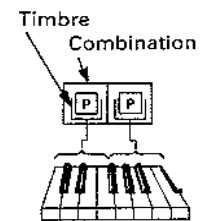

☆ Panning for Layer/Split/Velocity Switch

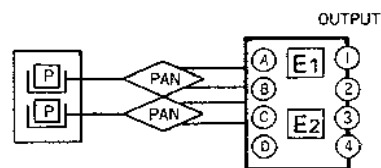



- The result of these settings is called a Combination. The M3R can store 100 Combinations (00–99). Combinations in internal memory can also be stored on a card.
- When the M3R is in COMBINATION PLAY mode, an incoming MIDI program change on the MIDI channel set in GLOBAL MODE will select a new Combination.
- If a Combination consists of timbres that are each receiving a different MIDI channel, incoming MIDI program changes for each Timbre will operate on the assigned MIDI channel.
- By making pan settings for the two effects outputs for each timbre, you can use effects creatively .
- The pan setting here is only the pan to the effect. To pan the sound to outputs 1–4, make settings in EFFECT mode.
- Drum kit pan settings made in DRUMS mode have priority. (These settings cannot be set in COMBINATION EDIT mode.)

☆ Panning for Multi

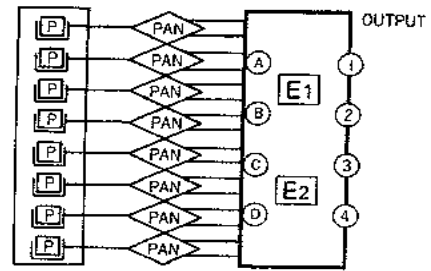

■ Panning (PANPOT)

- This determines the assignments to outputs A—D.
- Adjust the volume balance between A:B over the range of 1:9 to 9:1 ( $A + B = 10$ ).
- For C + D, C and D will be assigned the same volume level.

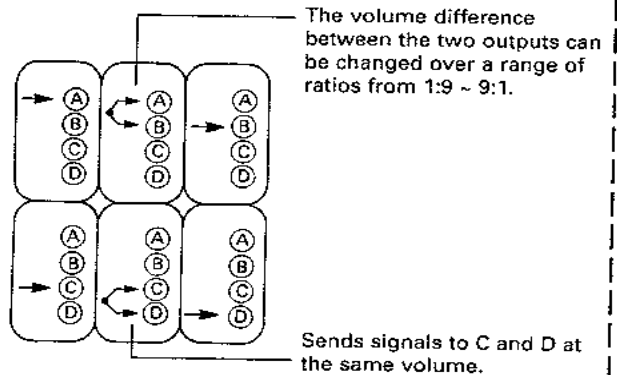

4 Finally, use EFFECT EDIT mode to add an effect to the completed Combination. (One set of effects can be used for each Combination.)

- PAN3 and PAN4 determine panning between EFFECT 1/2.

☆ When parallel is selected

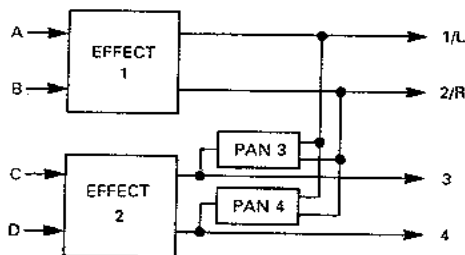

☆ When serial is selected

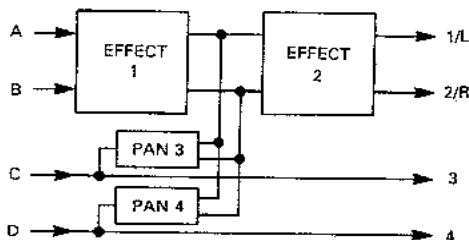

- In GLOBAL mode, you can make settings that determine the overall pitch, transpose, user scale, memory protect, and MIDI settings of the M3R. You can also transmit/receive data, and save/load data to/from a card and format a card.

# MODES AND KEY FUNCTIONS

(1) and (2) indicate the order in which keys should be pressed to enter each mode. The shaded boxes indicate keys whose indicators will light white in that mode.

### PROGRAM EDIT mode

To enter this mode

		②	
①			

Key functions in this mode

PLAY	PAGE+	▷	△/YES
EDIT	PAGE-	◁	▽/NO

### EFFECT mode

To enter this mode

			②
①			

Key functions in this mode

PLAY	PAGE+	▷	△/YES
EDIT	PAGE-	◁	▽/NO

### COMBINATION PLAY mode

To enter this mode

①			

Key functions in this mode

PLAY	CARD	+10	+1
EDIT	INT	-10	-1

### DRUMS mode

To enter this mode

①		②	

Key functions in this mode

PLAY	PAGE+	▷	△/YES
EDIT	PAGE-	◁	▽/NO

### COMBINATION EDIT mode

To enter this mode

	②		
①			

Key functions in this mode

PLAY	PAGE+	▷	△/YES
EDIT	PAGE-	◁	▽/NO

### GLOBAL mode

To enter this mode

①	②		

Key functions in this mode

PLAY	PAGE+	▷	△/YES
EDIT	PAGE-	◁	▽/NO

---

## Note

---

- When entering modes other than COMBINATION PLAY mode, first press the EDIT key (1), and then press the key for that mode (2).
- In all modes entered after pressing the EDIT key (all modes other than COMBINATION PLAY) the keys will function in the same way.

---

## Key functions

---

PLAY	Enter COMBINATION PLAY mode.
EDIT	Press when entering a mode other than combination play.
PAGE +	Move to the next parameter page of each mode.
PAGE -	Move to the previous parameter page of each mode.
▶	Move the cursor to the right.
◀	Move the cursor to the left.
△/YES	Increase the value of the parameter above the cursor, or answer a "OK?" prompt in the display.
▽/NO	Decrease the value of the parameter above the cursor, or answer a "OK?" prompt in the display.
CARD	Press when you want to play card sounds.
INT	Press when you want to play internal sounds.
+10	Increase the combination number by 10.
-10	Decrease the combination number by 10.
+1	Increase the combination number by 1.
-1	Decrease the combination number by 1.

# ABOUT THE DISPLAY

- ◆ The parameters of each mode are divided into pages. Use the PAGE +/- keys to move through the pages.
- ◆ Some pages are divided into 2-5 screens.

Whereas the control panel of older analog synthesizers used to be covered with an intimidating mass of knobs and patch leads, each dedicated to a particular function, the M3R (in common with other modern synthesizers) has only a few controls with a display to tell you what's going on. Of course, each control (key) has more than one function, depending on what you're doing at the time. Here's a brief guide to what each key does in various modes.

When you're playing combinations:

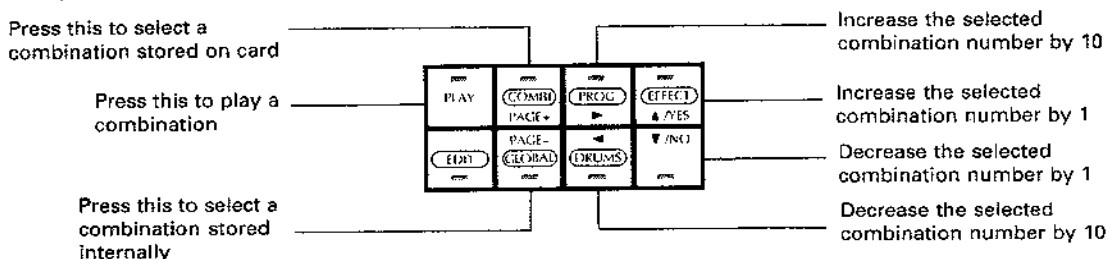

When you want to edit either a combination, a program, the digital effects, a drum kit, or to make changes to the global settings of the M3R, use the keys as follows:

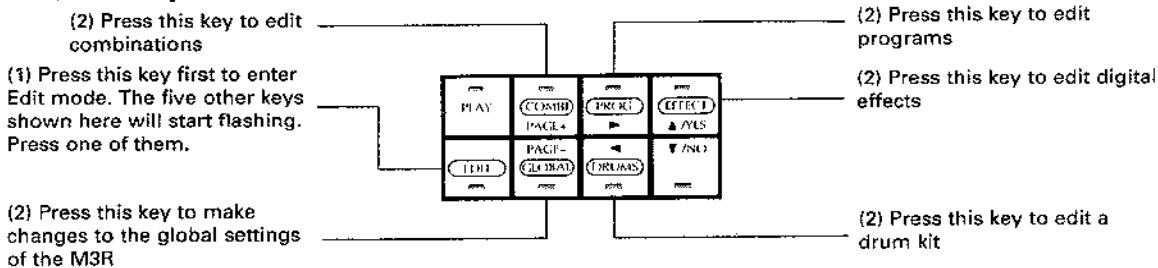

When you have selected what you want to edit, the keys will change function again. When you are editing, the display is not big enough to display all the parameters you may wish to change. For instance, the whole of the page dealing with selecting a Multisound ("Program edit") looks like this:

Sub-page A	Sub-page B	Sub-page C	Sub-page D	Sub-page E
1A OSC M.SOUND	1B OSC	1C OSC	1D OSC	1E OSC
23:Digi.Bell2	Level70 OCT 8'	Type:M.SOUND	Ass:POLY HLD:OFF	Delay=00

Accordingly, the display is divided into pages and "sub-pages". The current page number is displayed as a number in the upper left corner of the screen, thus:

0

and the current sub-page number is displayed as a letter immediately following the page number, thus:

0A

Further sub-pages may follow the current sub-page, and this is indicated by a flashing arrow at the upper right corner of the display:

0A PROG SELECT ▶  
 I21:DigiBell 2

If there are sub-pages which precede the current sub-page, a flashing left-hand arrow is shown at the upper right corner of the display:

0C RENAME ◀  
 I21:DigiBell 2

If there are sub-pages before and after the current sub-page, then the arrow at the upper right corner will flash alternately from a left-hand to a right-hand arrow:

0B PROG WRITE ◀▶  
 Write->I21 OK?

The parameter being edited will blink. Sometimes there will be more than one parameter in a sub-page, so it is necessary to press either the left or right arrow key to move to a different parameter.

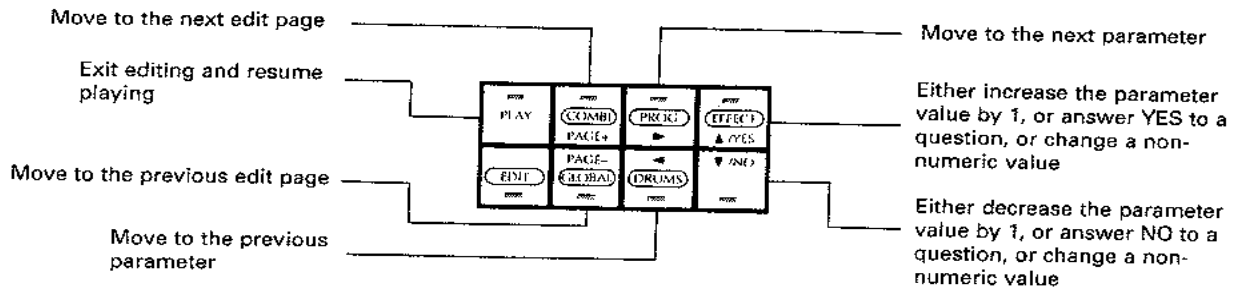

Though the theory may seem a little complex, the practice is easy, and you will soon find yourself pressing the right buttons without too much thought.

- ▷ This key moves the cursor to the right. When the upper line shows ▷ (or when ▷ and ◁ are alternately blinking), and the cursor is at the far right of the display, press this key to display the next screen to the right.
- ◁ This key moves the cursor to the left. When the upper line shows ◁ (or when ▷ and ◁ are alternately blinking), and the cursor is at the far left of the display, press this key to display the next screen to the left.
- △/YES These two keys modify the value (numerical data, etc.) above the cursor. △ increases the value, and ▽ decreases the value. When making a selection such as combination type, the types will change successively.
- ▽/NO When executing operations such as Write, a "YES/NO" display will appear, asking you to confirm. If you really want to execute the operation, press YES. If not, press NO.

## EFFECT INTERLOCK FUNCTION

The effects units built into the M3R can be set for each Combination. They cannot be set independently for each Program or Drum. However, when the Effect Interlock function is On, the Combination effect(s) selected before entering that mode (PROGRAM EDIT, DRUM, etc.) will be applied to the Program or Drum. Use GLOBAL mode [3C] EFFECT INTERLOCK to turn this function On/Off.

For Drum Kit pan settings of C, C+D, D, you will be able to monitor the sound of the Drum Kit by turning the effect placement setting for 3/4 On, and also turn effect interlock On so that you will hear the sound from 1/L, 2/R and the PHONES OUT.

## PAGE MEMORY FUNCTION

- ◆ Even if after editing a parameter in a mode, you move to another mode and then come back again to the parameter you were editing, the M3R allows you to return to the parameter you were editing (before you left the mode). Use GLOBAL mode [3D] PAGE MEMORY to turn this function On/Off. This setting is remembered even when the power is turned off.
  - In modes other than GLOBAL and DRUMS, this function is effective within a single combination/program. If you select another combination/program number when in a different mode, the Page Memory function will no longer work. (However it will be preserved if a Write operation changes the combination/program number.)
  - When editing in COMBINATION EDIT mode or PROGRAM EDIT mode, if you go to another mode and then return, the first screen in the mode will appear. Press the PAGE + key to get back the parameter you were previously editing.
  - In DRUMS mode, you will return to screen A of each page. (The index is memorized.)

# HOW THE M3R IS ORGANIZED

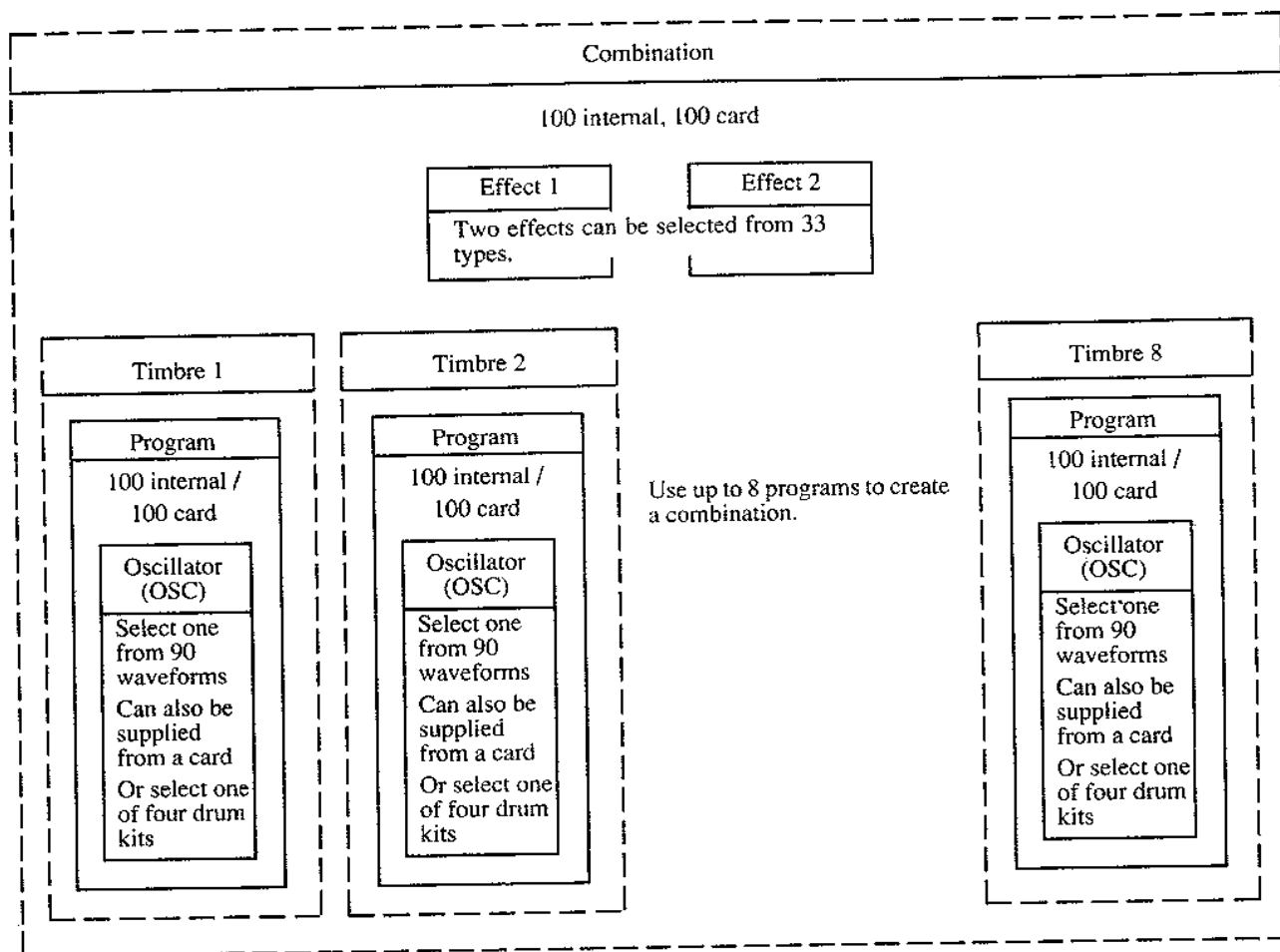

## MEMORY IN THE M3R

### Internal memory

RAM	100 combinations	100 programs	1 global	4 drum kits
ROM	5 demo songs			

### Program card memory

RAM	100 combinations	100 programs	1 global	4 drum kits
ROM	100 combinations	100 programs	1 global	4 drum kits
				demo songs

- ☆PCM cards are not included in this classification.
- ☆Use only Korg MCR-03 RAM cards.
- ☆Use the following functions to write to and read from cards.

	Read	Write
All programs / combinations	GLOBAL mode 5A	GLOBAL mode 5B
1 combination	COMBI PLAY, EDIT. mode 0A	EDIT COMBI mode 0B
1 program	EDIT PROG. mode 0A	EDIT PROG. mode 0B

# MODES AND FUNCTIONS

## HOW TO READ A DISPLAY PAGE CHART

2A—2C OSC PITCH EG (oscillator pitch EG) ———①

2A PITCH EG SL+00 AT00 AL+00	2B PITCH EG DT00 RT00 RL+00	2C P. VEL. SENS EGint+00 EGtm+00	②
---------------------------------	--------------------------------	-------------------------------------	---

2A	SL	Start Level	-99 – +99	Determine how OSC pitch changes over time
	AT	Attack Time	0 – 99	
	AL	Attack Level	-99 – +99	
2B	DT	Decay Time	0 – 99	
	RT	Release Time	0 – 99	
	RL	Release Level	-99 – +99	
2C	EGint	EG Level Vel. Sens.	-99 – +99	Determine how key velocity affects the pitch EG range
	EGtm	EG Time Vel. Sens.	-99 – +99	Determine how key velocity affects the pitch EG speed

③      ④      ⑤      ⑥      ⑦

- ① 2A—2C OSC PITCH EG (oscillator pitch EG) : Indicates that screens A—C of the second page contain parameters affecting the oscillator pitch EG.
- ② The screens of that page
- ③ The screen for each parameter
- ④ Parameter abbreviation shown in the display
- ⑤ Parameter name
- ⑥ Contents or value (number) range of parameter  
As the  $\nabla$ /NO key is pressed, the value shown will approach the minimum (left-hand) value in this column, and as the  $\Delta$ /YES key is pressed, the value shown will increase towards the maximum (right-hand) value.
- ⑦ Description of parameter function

# 1. PROGRAM EDIT MODE

To enter this mode,

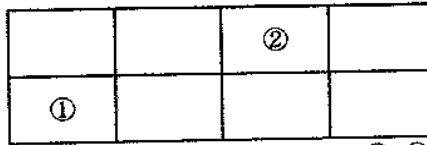

Press the keys in this order; ① ②

Key functions

PLAY	PAGE +	▷	△/YES
EDIT	PAGE -	◁	▽/NO

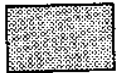
 = Keys whose indicators will light in this mode

- In this mode, you can make settings for sound program parameters (settings for waveform type, filter EG, etc.).
- When you finish editing the program, use [0B] Write Program to write your settings into memory. (If you use [0A]:PROGRAM SELECT to select another program, the program settings you have modified and not stored will be lost.)

## Structure of the M3R's program parameters

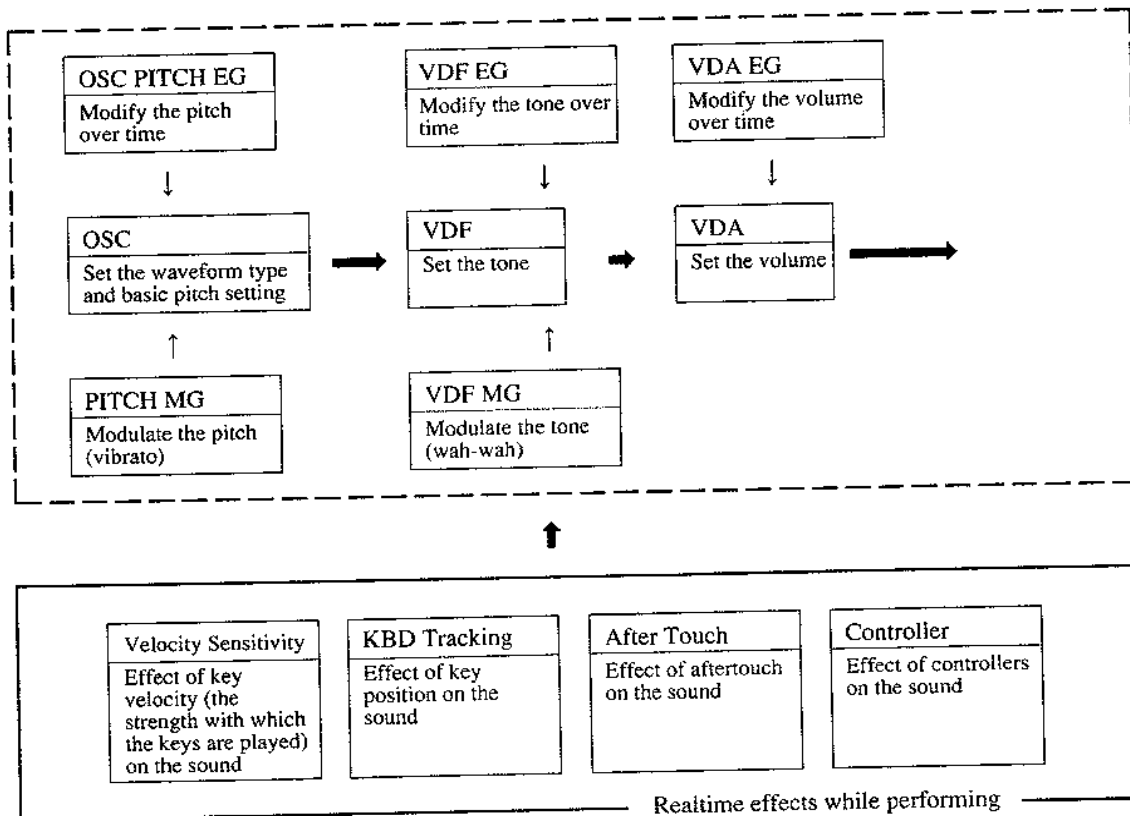



## Functions in Edit Program mode

- When you press the PAGE + or PAGE - keys, the first screen of each page ([□A]) will be selected (however for [0□] pages, [0B] WRITE instead of [0A] PAGE SELECT will be selected when you enter from other pages). Use the ▷ and ◁ keys to select a parameter to edit.

Page		Parameter to be edited	Page reference
0A – 0C	PROG SELECT WRITE/RENAME	Select a program Write or rename a program	18
1A – 1E	OSC	Oscillator waveform, level, octave mode, oscillator type, assign mode, hold Off/On, delay start	18
2A – 2C	OSC PITCH EG	Change in oscillator pitch over time	19
3A – 3D	VDF VDF EG	VDF cutoff, EG intensity Change in VDF cutoff over time	20
4A – 4D	VDF VEL SENS VDF KBD TRK	How key velocity affects VDF How key position affects VDF	21 22
5A – 5C	VDA EG	Change in VDA over time	23
6A – 6D	VDA VEL SENS VDA KBD TRK	How key velocity affects VDA How key position affects VDA	24
7A – 7D	PITCH MG VDF MG	Pitch modulation (vibrato) VDF modulation (wah-wah)	25
8A – 8C	AFTER TOUCH	How aftertouch affects the tone	26
9A – 9C	CONTROLLER	How controllers affect the tone	27

- The total pitch change resulting from pitch bend, pitch EG, pitch modulation, aftertouch, etc. is limited to one octave, (some Multisounds have an even smaller range in certain pitch ranges).
- Tonal changes caused by the VDF parameters, VDF-EG and VDF-MG are limited to the controllable range of the VDF.
- Volume changes caused by oscillator level, VDA and VDA-EG are limited to the controllable range of the VDA.
- When you first enter this mode, the [0A] Program Select display will appear. If the Page Memory function is On, pressing the PAGE+ button will return to the parameter you last selected in this mode before moving to another mode.
- When the Effect Interlock function is Off, no effect will be used in this mode. When it is On, an effect will be used, but will not be written into memory when you execute Program Write.

# EDIT PROGRAM

## 0A — 0C PROG SELECT / WRITE / RENAME

0A PROG SELECT 100 :Piano 16'	0B PROG WRITE Write→100 OK?	0C RENAME 100:Piano 16'
----------------------------------	--------------------------------	----------------------------

0A		Program Select	I00 - I99 C00 - C99	Select a program to edit
0B	Write	Destination Prog. No.	I00 - I99 C00 - C99	Program number to write
	OK?			Execute write
0C		Rename		Rename

▼ These functions write an edited program into internal memory or into a RAM card.

- (1) Use the ◀ ▶ △ /YES ▽ /NO keys to set the program name. (+1/YES and -1/NO step through the character table, and ◀ ▶ are used to position the cursor)
  - You can enter a ten-character name using characters and symbols.
  - If program memory protect is on, you will not be able to write. (Turn off memory protect using GLOBAL mode [3A].)

```
!"#$%&'()*+,-./0123456789:;<=>?
@ABCDEFGHIJKLMNOQRSTUVWXYZ[\]^_
`abcdefghijklmnopqrstuvwxyz{|}~
```

- (2) Select the program number ([0B]) of the program you wish to write to.
  - If a RAM card formatted to COMBI/PROG is inserted, you will also be able to select card memories (C00 — C99) (turn the card protect switch off before writing to a card).
- (3) Move the cursor to "OK?" and press the △ /YES key.
- (4) The display will ask "Are You Sure?", so if you want to write the data into memory, press △ /YES.
  - The program that was previously in that memory number will be overwritten.
  - If you press ▽ /NO, writing will be canceled.
- (5) When writing is completed, the display will show "Completed".
  - ☆ The writing operation in this page can be used to copy a program to another program number.

## 1A — 1E OSC (oscillator)

1A OSC M. SOUND  
00:Piano

1B OSC  
Level 80 OCT16'

1C OSC  
Type:M. SOUND

1D OSC  
Ass:POLY HLD:OFF

1E OSC  
Delay=00

1A		Multisound Drums	(Multisound) 00-89 Drumkit1 - Drumkit4 DrumkitC1 - DrumkitC4	Select an OSC multisound (waveform) Select a drum kit (when OSC is set to DRUMS)
1B	Level	OSC Level	0-99	Oscillator volume
	OCT	Octave	16' 8' 4'	Octave setting of oscillator One octave below standard pitch Standard pitch One octave above standard pitch
1C	Type	OSC Type	M.SOUND DRUMS	Type of tone generator Multisound type Drum kit type
1D	Ass	Assign	POLY MONO	Maximum number of voices sounded Play polyphonically up to maximum number of notes Play monophonically
	HLD	Hold	OFF/ON	Hold sound even after key is released
1E	Delay	Delay Start	0-99	Delay from when key is pressed to when oscillator is sounded

▼ When M.SOUND is selected for [1C] OSC Type, select the oscillator type in [1A] Multisound (the back cover has a list of multisounds).

- Each multisound has an upper pitch limit, and playing notes above this limit will produce no sound.
- If an optional PCM card is inserted into the PCM slot, multisounds can be selected from the card as well. If you continue pressing the  $\Delta$  /YES key after "I89", card multisounds beginning with 'C' will be displayed.

☆ **About PCM cards**

Only insert and remove PCM cards when no sound is being produced.

- Multisounds with a name including "NT" will produce the same pitch, regardless of which key is pressed.

▼ When DRUMS is selected for OSC Type, select from Drumkit 1-4 and Drumkit C1-C4 (when a PROG card is inserted).

- In DRUMS mode you can assign drum sounds to a drum kit (Drumkit 1-4).

▼ OSC Level (oscillator level) sets the volume level of the oscillator. 99 is maximum.

- For some voices, setting the oscillator level to the maximum value will result in distorted sound when chords are played. In such case, lower the oscillator level.

▼ Octave sets the basic pitch of the oscillator in steps of an octave.

▼ OSC Type (oscillator type) selects the type of sound source for the program you are creating.

- After changing the OSC Type setting, make settings for [1A] OSC multisound (drum kit) once again.
- This mode allows you to use a drum kit consisting of a set of drum sounds as the sound source.

▼ Assign determines whether this program will be used for chords or for monophonic playing.

▼ If Hold is ON, sound will continue even after a key is released (just as though you had continued pressing the key). This is useful mainly for drum kit sounds.

- If you turn Hold ON for a sustained sound, the sound will continue indefinitely.

▼ Delay Start is the time delay (0-99) from when the key is pressed to when the oscillator begins sounding (if you don't want a delay, set this to 0).

## 2A — 2C OSC PITCH EG (oscillator pitch EG)

2A PITCH EG SL+00 AT00 AL+00	2B PITCH EG DT00 RT00 RL+00	2C P. VEL. SENS EGint+00 EGtm+00
---------------------------------	--------------------------------	-------------------------------------

2A	SL	Start Level	-99 - +99	These parameters affect the Shape of the OSC Pitch EG 
	AT	Attack Time	0 - 99	
	AL	Attack Level	-99 - +99	
2B	DT	Decay Time	0 - 99	
	RT	Release Time	0 - 99	
	RL	Release Level	-99 - +99	
2C	EGint	EG Level Vel. Sens.	-99 - +99	How key velocity affects EG level
	EGtm	EG Time Vel. Sens.	-99 - +99	How key velocity affects EG time

\* An EG (envelope generator) affects the sound over time. For example, a pitch EG controls the change in pitch over time.

▼ This determines the change in oscillator pitch over time.  
 • If the EG levels are reversed (+ and -), the EG shape will be inverted.

▼ When EG Level Vel. Sens. (EG level velocity sensitivity) is set to a positive "+" value, the pitch change will increase as you play more strongly (when set to negative "-" values, the opposite will be the case). However the pitch change produced by the EG is limited to  $\pm 1$  octave.  
 • For positive "+" settings:

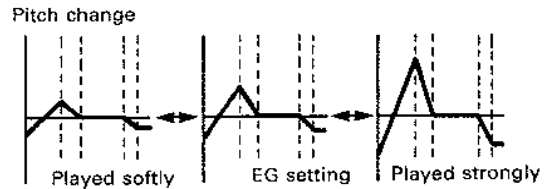

▼ When EG Time Vel. Sens. (EG time velocity sensitivity) is set to a positive "+" value, the time will be shorter as you play more strongly. (When set to negative "-" values, the opposite will be the case.)  
 • For positive "+" settings:

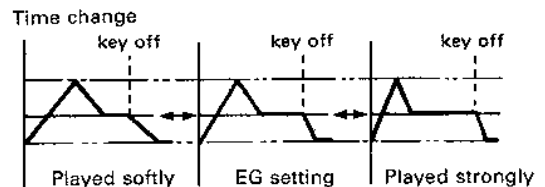

### 3A — 3D VDF / VDF EG

3A VDF Fc38 EGint49	3B VDF EG AT00 AL+94 DT94	3C VDF EG BP+01 ST80 SL+00	3D VDF EG RT99 RL+99
------------------------	------------------------------	-------------------------------	-------------------------

3A	Fc	Cutoff	0 – 99	VDF cutoff (adjusts the brightness of the tone)
	EGint	EG Intensity	0 – 99	
	AT	Attack Time	0 – 99	These parameters affect the shape of the VDF EG.
3B	AL	Attack Level	-99 – +99	
	DT	Decay Time	0 – 99	
3C	BP	Break Point	-99 – +99	
	ST	Slope Time	0 – 99	
	SL	Sustain Level	-99 – +99	
3D	RT	Release Time	0 – 99	
	RL	Release Level	-99 – +99	

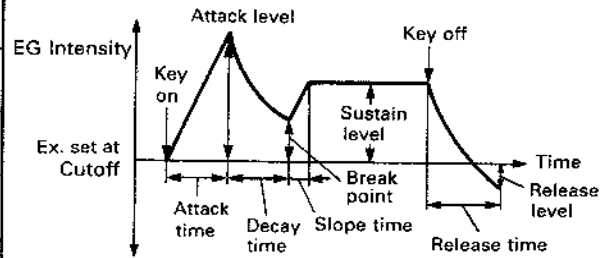

The VDF (Variable Digital Filter) regulates the tone by decreasing (cutting off) the overtones of the high frequency range.

- ▼ Cutoff sets the cutoff frequency of the VDF. Lower settings will result in a softer tone.
- ▼ EG Intensity determines the amount of change (cutoff) produced by the VDF EG explained in the following item. A setting of 99 allows the cutoff EG to have maximum effect.

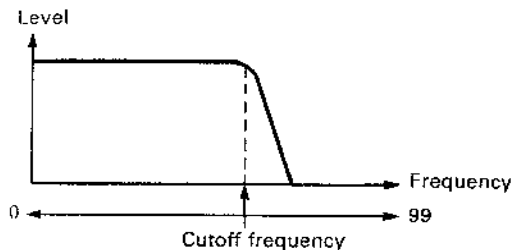

- \* The VDF EG determines the change over time of the VDF cutoff.
  - If the EG levels are reversed (+ and -), the EG shape will be inverted.
  - All EG levels are adjusted equally by the VDF EG intensity.

#### 4A — 4D VDF VEL SENS / KBD TRACK (VDF velocity sensitivity / keyboard tracking)

4A VDF V. SENS  
EGint+84 EGtm03

4B VDF V. SENS  
ATO DT+ STO RTO

4C VDF K. TRK  
F#3 F-58 EGtm00

4D VDF K. TRK  
ATO DTO STO RTO

4A	EGint	EG Intensity	-99 - +99	How key velocity affects VDF EG intensity
	EGtm	EG Time	0 - 99	How key velocity affects VDF EG time
4B	AT	Attack Time	-, 0, +	The EG time velocity sensitivity setting can be applied to each of these parameters (Attack Time, etc.) in a different way; negative (-), positive (+), or not applied (0).
	DT	Decay Time	-, 0, +	
	ST	Slope Time	-, 0, +	
	RT	Release Time	-, 0, +	
4C		Center Key	C-1 - G9	The key which will be the center of VDF keyboard tracking (the $\pm 0$ key)
	F	Cutoff	-99 - +99	How key position affects VDF cutoff (brightness)
	EGtm	EG Time	0 - 99	How key position affects VDF EG speed
4D	AT	Attack Time	-, 0, +	The EG time keyboard tracking setting can be applied to each of these parameters (Attack Time, etc.) in a different way; negative (-), positive (+), or not applied (0).
	DT	Decay Time	-, 0, +	
	ST	Slope Time	-, 0, +	
	RT	Release Time	-, 0, +	

▼ EG Intensity (EG intensity velocity sensitivity) determines the effect which key velocity will have on the tone.

- For positive "+" settings, stronger playing will increase the effect of the VDF EG on the cutoff.
- For negative "-" settings, stronger playing will decrease the effect of the VDF EG on the cutoff. The setting for EG Intensity is the standard value (0).
- When set to a positive value:

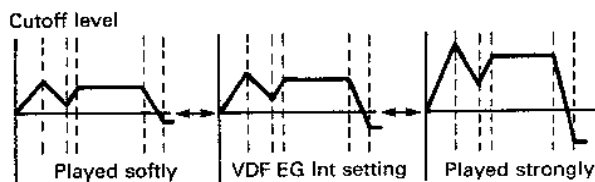

▼ EG Time (EG time velocity sensitivity) determines the effect which key velocity will have on the VDF EG speed. For positive "+" settings, stronger playing will shorten the time of the EG (Attack / Decay / Slope / Release Time). (Negative "-" settings will have the opposite effect.)

- When all are set to a positive "+" value:

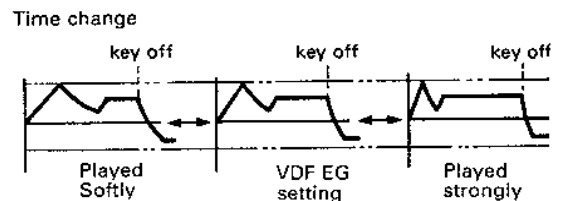

☆ For most acoustic instruments, softer notes have fewer high-frequency components. To simulate this, set a low cutoff for the VDF, and set positive values for all parameters for VDF EG sustain levels, VDF EG intensity, and VDF EG intensity velocity sensitivity.

☆ VDF keyboard tracking determines how key position (the number of the played key) will affect the VDF cutoff and the various times of the EG.

▼ Center Key sets the central key (the key for which cutoff/EG time does not change) for VDF keyboard tracking.

▼ Positive "+" settings of Cutoff will result in a brighter sound as higher notes are played. Negative "-" settings will have the opposite effect. As the setting approaches -99 or +99, the effect will become greater. For a setting of 0, the change in cutoff will be equal to the change in pitch.

• A setting of -50 results in a horizontal curve (key position will have no effect on the VDF).

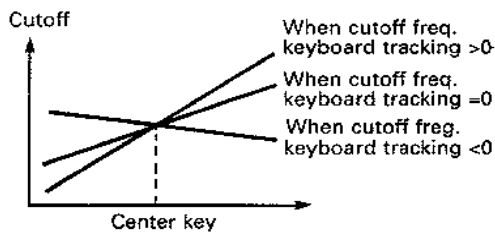

▼ For positive "+" settings of EG Time (EG time keyboard tracking), notes higher than the center key will have an increasingly shorter VDF EG time (Attack / Decay / Slope / Release Time). Negative "-" settings will have the opposite effect.

Time change

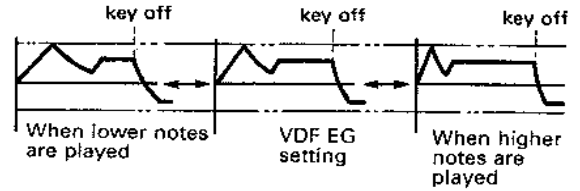

### 5A — 5C VDA EG

5A VDA EG AT00 AL75 DT22	5B VDA EG BP99 ST93 SL00	5C VDA EG RT28
-----------------------------	-----------------------------	-------------------

5A	AT	Attack Time	0 - 99	<p>VDA volume change over time</p> <p>The graph shows Volume on the vertical axis and time on the horizontal axis. Key events are marked: Key on, Attack level, Key off. Time intervals are marked: Attack time, Slope time, Decay time, Release time. Levels are marked: Sustain level, Break point.</p>
	AL	Attack Level	0 - 99	
	DT	Decay Time	0 - 99	
5B	BP	Break Point	0 - 99	
	ST	Slope Time	0 - 99	
	SL	Sustain Level	0 - 99	
5C	RT	Release Time	0 - 99	

\* The VDA (variable digital amplifier) changes the volume of the waveform over time.

▼ The VDA EG determines how the volume changes over time.

## 6A — 6D VDA VEL SENS / KBD TRK (VDA velocity sensitivity / keyboard tracking)

6A VDA V. SENS Amp+76 EGtm00	6B VDA V. SENS AT0 DT0 ST0 RT0	6C VDA K. TRK F#4 A+00 EGtm00	6D VDA K. TRK ATO DTO STO RT0
---------------------------------	-----------------------------------	----------------------------------	----------------------------------

6A	Amp	Amplitude	-99 - +99	How key velocity affects VDA EG intensity
	EGtm	EG Time	0 - 99	How key velocity affects VDA EG time
6B	AT	Attack Time	-, 0, +	The EG time velocity sensitivity setting can be applied to each of these parameters (Attack Time, etc.) in a different way; negative (-), positive (+), or not applied (0).
	DT	Decay Time	-, 0, +	
	ST	Slope Time	-, 0, +	
	RT	Release Time	-, 0, +	
6C		Center Key	C-1 - G9	The center key for VDA keyboard tracking ( $\pm 0$ key)
	A	Amplitude (amplitude keyboard tracking)	-99 - +99	How key position affects VDA volume change
	EGtm	EG Time (EG time keyboard tracking)	0 - 99	How key position affects VDA EG speed
6D	AT	Attack Time	-, 0, +	The EG time keyboard tracking setting can be applied to each of these parameters (Attack Time, etc.) in a different way; negative (-), positive (+), or not applied (0).
	DT	Decay Time	-, 0, +	
	ST	Slope Time	-, 0, +	
	RT	Release Time	-, 0, +	

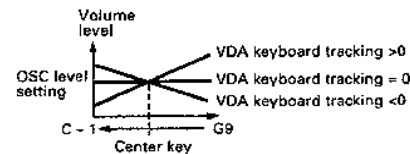

▼ Amplitude (amplitude velocity sensitivity) determines how the key velocity will affect the volume. Positive “+” settings will result in a louder volume as you play more strongly. Negative “-” settings will result in a softer volume as you play more strongly. As the setting approaches -99 or +99, key velocity will have a greater effect on the volume.

▼ EG Time (EG time velocity sensitivity) determines how the key velocity will affect the speed of the VDA EG. Positive “+” settings will result in a shorter VDA EG time (Attack / Decay / Slope / Release Time) as you play more strongly. Negative “-” settings will result in a longer VDA EG time as you play more strongly.

• When all are set to a positive “+” value:

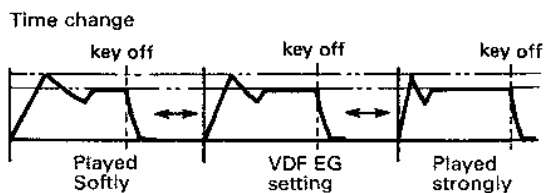

☆ For sounds such as strings, setting a positive “+” attack time will result in a sharp attack for strongly played notes, and a slow attack for softly played notes.

\* VDA keyboard tracking determines how the key position will affect the VDA volume and the various times of the EG.

▼ Center Key sets the central key (the key for which volume / EG time does not change) for VDA keyboard tracking.

▼ Positive “+” settings of Amplitude will result in a louder volume for higher notes. Negative “-” settings will result in a softer volume for higher notes.

• The volume resulting from the keyboard tracking setting will remain in the range of 0-99 (the maximum value of OSC level).

▼ Positive “+” settings of EG Time (EG time keyboard tracking) will result in an increasingly shorter VDA EG time (Attack / Decay / Slope / Release Time) for notes above the center key. Negative “-” settings will result in the opposite effect.

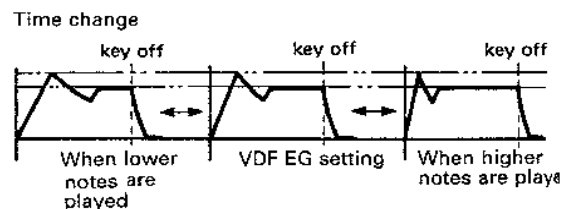







## 7A — 7D PITCH MG / VDF MG (pitch modulation / VDF modulation)

7A PITCH MG  
TRI Frq64 Dly00

7B PITCH MG  
Int00 K.Sync:OFF



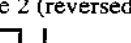

7C VDF MG  
TRI Frq64 Dly00

7D VDF MG  
Int00 K.Sync:OFF

7A		Waveform	TRI SAW ↑ SAW ↓ SQR	Select the modulation waveform Triangle wave  Sawtooth wave 1  Sawtooth wave 2 (reversed polarity)  Square wave 
	Frq	Frequency	0 - 99	The speed of the modulation effect
	Dly	Delay	0 - 99	The delay from when the note is played to when the modulation begins
7B	Int	Intensity	0 - 99	The intensity of the modulation effect
	K.Sync	Key Sync	OFF ON	Modulation affects each note in the same way
7C		Waveform	The same as for 7A	
	Frq	Frequency		
	Dly	Delay		
7D	Int	Intensity	The same as for 7B	
	K.Sync	Key Sync		

\* Pitch MG (pitch modulation) periodically changes (adds vibrato to) the pitch.

▼ Waveform selects the modulation waveform (shape of change).

- TRI  Triangle wave (most frequently used)
- SAW ↑  Sawtooth wave 1
- SAW ↓  Sawtooth wave 2 (reversed polarity)
- SQR  Square wave

▼ Frequency determines the speed of the modulation. 99 is the fastest.

• When triangle wave modulation is selected:

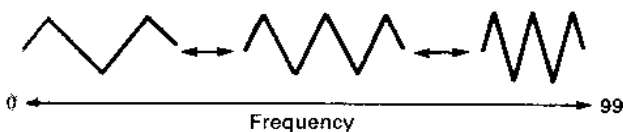

▼ Delay is the time from when the note is played to when the modulation begins.

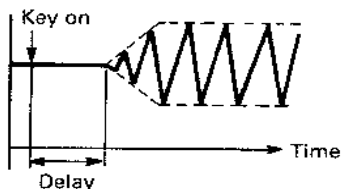

▼ Intensity is the depth of modulation

• When triangle wave modulation is selected:



▼ When Key Sync is set ON, the modulation waveform will begin again as each note is played.

• Key Sync ON

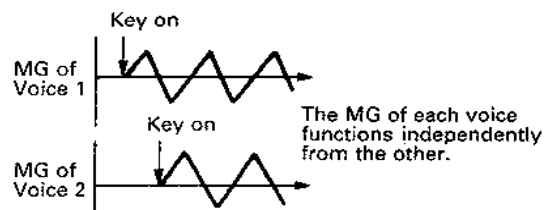

• Key Sync OFF

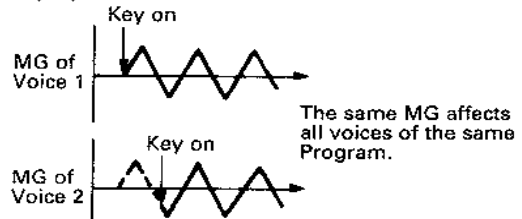

\* VDF MG (VDF modulation) periodically modulates the cutoff frequency (wah-wah effect).

• Details are the same as for [7A] — [7B] Pitch MG.

• If the VDF MG waveform is SQR, there will no effect when the VDF cutoff is raised.

## 8A — 8C AFTERTOUCH

8A AFTER TOUCH Pitch+00 P.MG00	8B AFTER TOUCH Fc+00 VDF.MG00	8C AFTER TOUCH Amp+00
-----------------------------------	----------------------------------	--------------------------

8A	Pitch	PITCH	-12 – +12	How aftertouch affects pitch (within $\pm 1$ octave)
	P.MG	Pitch MG	0 – 99	How aftertouch affects pitch modulation
8B	Fc	VDF Cutoff	-99 – +99	How aftertouch affects cutoff (tone)
	VDF.MG	VDF MG	0 – 99	How aftertouch affects VDF modulation
8C	Amp	VDA Amplitude	-99 – +99	How aftertouch affects volume

\* Aftertouch allows you to modify the sound by pressing down on the keyboard after playing a note.

▼ Pitch determines the amount and direction in which aftertouch will affect pitch, over a range of -12 to +12 ( $\pm 1$  octave in semitone steps).

▼ Higher settings of Pitch MG (pitch modulation) will result in a greater pitch MG effect as you press harder on the keyboard. At a setting of 0, aftertouch will have no effect.

☆ The settings of [7A] [7B] Pitch MG (pitch MG waveform and key sync) will be used.

▼ Positive "+" settings of VDF Cutoff will make the cutoff value increase (the sound becomes brighter) as you press harder on the keyboard. Negative "-" settings will have the opposite effect.

▼ Higher settings of VDF MG (VDF modulation) will result in a greater VDF MG effect as you press harder on the keyboard. At a setting of 0, aftertouch will have no effect.

☆ The settings of [7C] [7D] VDF MG will be used.

▼ Positive "+" settings of VDA Amplitude will result in an increased volume as you press harder on the keyboard. Negative "-" settings will have the opposite effect.

## 9A — 9C CONTROLLER BEND/SWEEP

9A BEND/SWEEP  
P. Bend+02 VDF+00

9B PITCH CTRL  
MGint05 MGfreq0

9C VDF CTRL  
MGint10 MGfreq0

9A	P.Bend	Pitch Bend	-12 – +12	Maximum amount of pitch change
	VDF	VDF Sweep Intensity	-99 – +99	How pitch bend affects VDF cutoff
9B	MGint	Pitch MG Intensity	-99 – +99	How controllers affect the pitch modulation intensity
	MGfreq	Pitch MG Frequency	0 – 3	How controllers affect the pitch modulation frequency
9C	MGint	VDF MG Intensity	0 – 99	How controllers affect the VDF modulation intensity
	MGfreq	VDF MG Frequency	0 – 3	How controllers affect the VDF modulation frequency

\* These functions determine how the joysticks, modulation wheels, etc. of external MIDI keyboards will affect the sound of the M3R. The M3R receives pitch bender messages to control pitch bend and VDF sweep, control change 1 to control pitch modulation, and control change 2 to control VDF modulation.

• When the M3R is connected to an M1, DS-8, DSS1, etc., left/right movement of the joystick will control pitch bend, upward movement will control pitch modulation, and downward movement will control VDF modulation.

▼ Pitch Bend determines the range in semitones over which pitch can be changed by a pitch bend wheel or other controller. For the maximum setting of 12, the range of pitch change will be 1 octave.

▼ VDF Sweep Intensity determines how the pitch bender will affect VDF cutoff.

▼ Higher settings of Pitch MG Intensity will make a joystick etc. have a greater effect on pitch modulation.

▼ Pitch MG Frequency determines how a joystick etc. will affect the speed of pitch modulation.

☆ At a setting of 0, the speed that was set in [7A] will be used. For settings of 1–3, the joystick etc. will increase the speed that was set in [7A].

☆ The settings of [7A] [7B] Pitch MG will determine the pitch modulation waveform and key sync.

▼ Higher settings of VDF MG Intensity will make a joystick etc. have a greater effect on VDF modulation intensity.

▼ VDF MG Frequency determines how a joystick etc. will affect the speed of VDF MG.

☆ The settings of [7C] [7D] VDF MG will determine the waveform and key sync of the VDF MG.

## 2. COMBINATION PLAY MODE

To enter this mode

①			

①=press this key

Key functions

PLAY	CARD	+10	+1
EDIT	INT	-10	-1

= Keys whose indicators light when in this mode

In this mode, you can select and play a Combination (a combination of two or more programs). Combinations can be selected using the +10, +1, -1, and -10 keys or by MIDI program changes.

- When "INT" is selected, combinations will be selected from internal memory, and when "CARD" is selected, from a card.
- When selecting a combination via MIDI, use GLOBAL mode [2A] to set the MIDI channel of the M3R to match the channel of the transmitting device, and set [2B] to activate the function.
- ☆ In multi mode, program changes are received independently by each timbre on its own MIDI channel, but when a program change is received on the global MIDI channel, it will change Combinations.
- ☆ There is no restriction on the number of simultaneous notes that can be produced by an individual Program. (Notes will be produced until the total number of oscillators used by all voices reaches 16.)
- The display in COMBINATION mode will differ according to the type of each combination.

The page memory function can be used when the RE1 is connected (when On).

## SINGLE

COMBINATION NO.

COMBINATION NAME

101 GrandPiano

		Combination	I00 - I99 C00 - C99	Select a combination
--	--	-------------	------------------------	----------------------

## LAYER

COMBINATION NO.

COMBINATION NAME

103 String Pad  
P1:137 P2:136

LAYER 2 PROGRAM

LAYER 1 PROGRAM

		Combination	I00 - I99 C00 - C99	Select a combination
--	--	-------------	------------------------	----------------------

## SPLIT

COMBINATION NO.

COMBINATION NAME

C01 Combi 001  
Low:C02 Up:C98

UPPER PROGRAM

LOWER PROGRAM

		Combination	I00 - I99 C00 - C99	Select a combination
--	--	-------------	------------------------	----------------------

## VELOCITY SW

COMBINATION NO.

COMBINATION NAME

C02 Combi 002  
Soft:102 Loud:197

LOUD PROGRAM

SOFT PROGRAM

		Combination	I00 - I99 C00 - C99	Select a combination
--	--	-------------	------------------------	----------------------

## MULTI

COMBINATION NO.

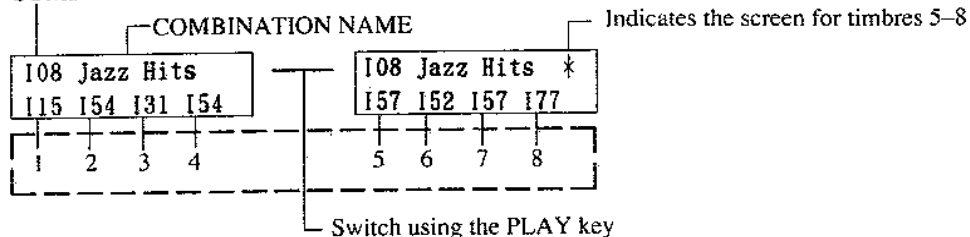

	Combination	I00 - I99 C00 - C99	Select a combination
--	-------------	------------------------	----------------------

When MIDI data is received by timbres 1 - 8, the corresponding front panel LED for each timbre will blink on. (The keys correspond to timbres 1 - 8 as shown in the diagram at right.) Keys whose LED is already lit to indicate the selected mode will blink off.

T1	T2	T3	T4
T5	T6	T7	T8

- When in Single mode, T1 will light. When in Layer, Split, or Vel.SW modes T1 and T2 will light (or go out) simultaneously.
- When receiving exclusive data, the LEDs currently on (for mode indication) will go off.

### 3. COMBINATION EDIT MODE

To enter this mode

	②		
①			

① ② = press this key

Key functions

PLAY	PAGE+	▷	△/YES
EDIT	PAGE-	◁	▽/NO

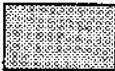
 = Keys whose indicators light when in this mode

In this mode you can create a Combination of two or more programs.

There are five types of M3R Combinations; SINGLE, LAYER, SPLIT, VELOCITY SPLIT, and MULTI. Each Combination consists of 1—8 timbres. Each timbre consists of a program, and performance and output parameters (pan, level, MIDI channel, etc.). Each Combination also has a set of effect parameters which affect the entire combination.

- Use [0A] COMB SELECT to select the combination to edit.
- When you have finished editing a Combination, use [0B] Combination Write to write the data into memory. (If you use [0A] to select another Combination before writing your edited settings into memory, your edits will be lost.)
- If a memory card containing program data is inserted into the front panel slot, you will be able to select programs from the card. (When using a Combination which uses card programs, be sure that the appropriate card is inserted. If a card is not inserted, there will be no sound when the card number is selected. If an inserted card is removed, the internal program of the same number will be used instead.)

Parameters will differ according to the type of combination, so the following explanation is divided by combination type. Refer to the explanation for the selected type of combination.

## About combination types

### Single

This combination type consists of a single program.

- ☆ If you write an unmodified program into memory as a single combination, you will be able to change sounds without having to switch between program and combination modes.

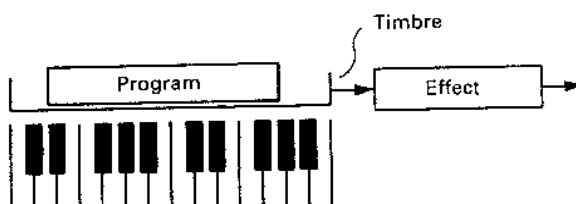

### Layer

This combination type allows you to play two timbres mixed together.

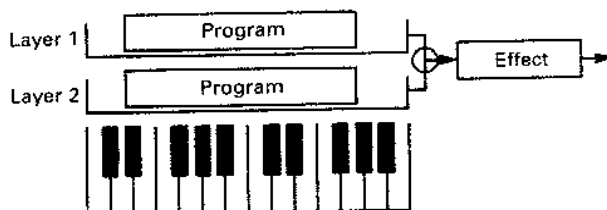

### Split

This combination type allows you to play two timbres from different ranges of the keyboard.

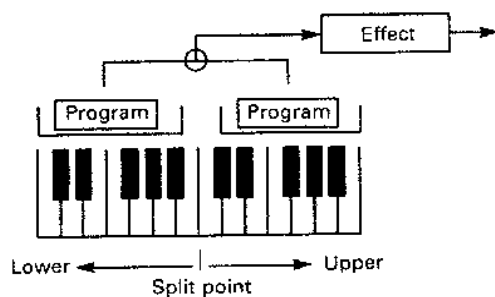



## Velocity switch

This combination type allows you to select between two timbres by the force of your playing (key velocity).

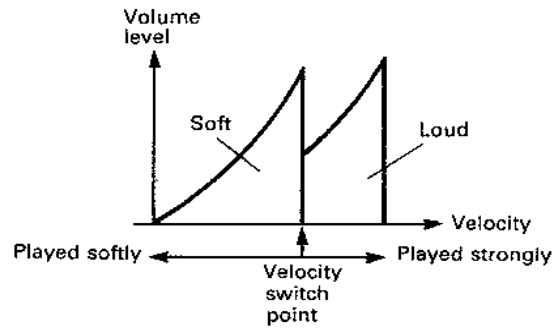

## Multi

A multi combination allows you to use up to 8 timbres, each with its own independent program, MIDI channel, keyboard range, and velocity range. This allows you to use the M3R as a multi-timbral tone generator, or to create complex split and layering effects that would not be possible with other combination types.

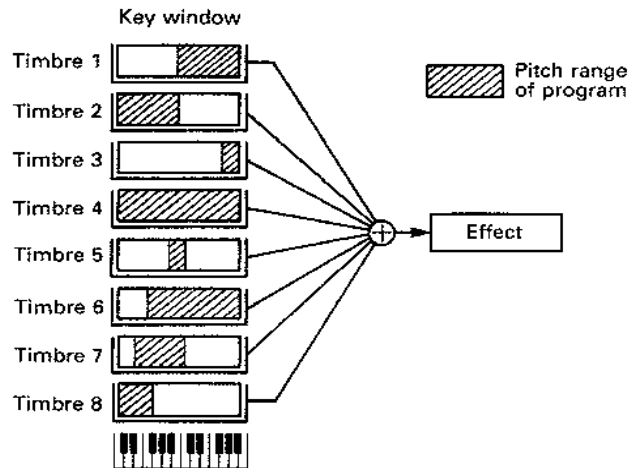

## Functions common to all combination types

- When you first enter COMBINATION EDIT mode, the [0A] COMBINATION SELECT page will appear. Pressing the PAGE+ button when the Page Memory function is on will jump to the parameter last selected in this mode before moving to another mode. Use the PAGE + and PAGE – keys to select the page that contains the parameters you want to edit (However if you enter page 0 [] from another page, 0B Comb Write will be selected instead of 0A Comb Select.)
- The functions of page 2 and later pages will differ according to the Combination type. Refer to the explanation for the appropriate Combination type.
- Effect settings can be made in EFFECT EDIT mode, and stored for each Combination number.

Page		Parameter to edit	Page reference
0A – 0C	COMBINATION SELECT WRITE/RENAME	Select a Combination Write / rename a combination	34
1A	TYPE SELECT	Select a combination type	35

### 0A — 0C SELECT / WRITE / RENAME

0A COMB SELECT 100 :Krypton	0B COMB WRITE Write→100 OK?	0C RENAME 100:Krypton
--------------------------------	--------------------------------	--------------------------

0A		COMBINATION SELECT	100 – 199 C00 – C99	Select a combination
0B		Destination Prog. No.	100 – 199 C00 – C99	Combination number to write
	[OK?]			Execute writing
0C				Rename

▼ This function is used to write an edited Combination into internal memory or into a RAM card.

- Writing is not possible if combination memory protect is “ON”. Turn memory protect off in GLOBAL mode [3B].

(1) In [0C], use the ▷, ◁, △/YES, and ▽/NO keys to enter a combination name.

- You may assign a 10-character name using characters and symbols.

(2) In [0B], select the combination number for the writing destination.

- If a RAM card formatted to COMBI/PROG is inserted, you will also be able to select card memories (C00 – C99). Before writing data into a card, turn the card protect switch to “OFF”.

(3) Move the cursor to “OK?” and press △/YES.

(4) The display will ask “Are You Sure?”, so if you want to write the data into memory, press △/YES again.

- The Combination data previously in that memory will be lost.
- If you press ▽/NO, writing will be canceled.

(5) When writing ends, the display will show “Write Completed”.

☆ Use this writing function when copying a Combination to another combination number.

## 1A TYPE SELECT

1A TYPE SELECT  
MULTI OK?

1A		TYPE SELECT	SINGLE LAYER SPLIT VEL. SW MULTI	Select a combination type Single Layer Split Velocity switch Multi
	OK?	[OK?]		Confirm selection

▼ Use TYPE SELECT to select the type of combination.

- Select a new type, move the cursor to "OK?" and press  $\Delta$ /YES, and the specified combination type will be selected. If you move to another page without pressing  $\Delta$ /YES, your choice will be canceled.

## SINGLE type functions

Page		Parameter to edit	Page reference
1A	PROGRAM	Program number	35
1A	LEVEL/PANPOT	Level / pan (output destination)	35

## A PROGRAM

1A SINGLE  
100: Piano 16'

1A		Program	I00 – I99 C00 – C99	Select a program number
----	--	---------	------------------------	-------------------------

## A LEVEL / PANPOT

1A SINGLE  
Level=99 Pan=5:5

1A	Level	Level	0 – 99	Level (volume) setting
	Pan	Panpot	A, 9:1 – 1:9, B, C, C+D, D	Output destination setting

▼ Level determines the volume. For a setting of 99 the volume will be the full volume as set by the Program parameter. A setting of 0 completely mutes the Program.

▼ Panpot determines the output destination. Select from A, A:B (9:1 to 1:9), B, C, C+D, and D.

- When a drum kit program is selected, the display will indicate "SND", and the pan settings of DRUMS mode will be used (This setting cannot be made here.)

## LAYER type functions

Page		Parameter to edit	Page reference
2A – 2C	LAYER1 PROG/LEVEL/ PANPOT/DAMPER FILTER	Layer 1 program number, output level, pan (output destination), and damper	36
3A – 3D	LAYER2 PROG /LEVEL/ PANPOT / INTERVAL / DETUNE / DAMPER FILTER	Layer 2 program number, output level, pan (output destination), and damper	37

### 2A — 2C LAYER1 PROGRAM / LEVEL / PANPOT / DAMPER FILTER

2A LAYER 1 137:Analog 1	2B LAYER 1 Level=99 Pan=5 :5	2C LAYER 1 Damper=ENA
----------------------------	---------------------------------	--------------------------

2A		Layer 1 Program	I00 – I99 C00 – C99	Layer 1 program number
2B	Level	Layer 1 Level	0 – 99	Layer 1 level adjustment
	Pan	Layer 1 Panpot	A, 9:1 – 1:9, B, C, C+D, D	Layer 1 output destination
2C	Damper	Layer 1 Damper Filter	DIS/ENA (Disable/Enable)	Layer 1 damper disable/enable

- ▼ Layer 1 Program sets the program number for layer 1.
- ▼ Layer 1 Level sets the volume for layer 1. For a setting of 99 the volume will be the full volume as set by the Program parameter. A setting of 0 completely mutes the program.
- ▼ Layer 1 Panpot determines the output destination of layer 1. Select from A, A:B (9:1 to 1:9), B, C, C+D, and D.
  - When a drum kit program is selected, the display will indicate “SND”, and the pan settings of DRUMS mode will be used. (This setting cannot be made here.)
- ▼ When Layer 1 Damper Filter is set to “DIS” (disable) the damper pedal will not affect the sound of layer 1.

**3A — 3D LAYER2 PROGRAM / LEVEL / PANPOT / INTERVAL / DETUNE / DAMPER FILTER**

3A LAYER 2  
136: Strings

3B LAYER 2  
Level=42 Pan=C+D

3C LAYER 2  
INT=-12 Tune=+00

3D LAYER 2  
Damper=ENA

3A		Layer 2 Program	100 – 199 C00 – C99	Layer 2 program number
3B	Level	Layer 2 Level	0 – 99	Layer 2 level adjustment
	Pan	Layer 2 Panpot	A, 9:1 – 1:9, B, C, C + D, D	Layer 2 output destination
3C	INT	Layer 2 Interval	-24 – +24	Pitch difference between layer 1 and layer 2 (semitones steps)
	Tune	Layer 2 Detune	-50 – +50	Pitch difference between layer 1 and layer 2 (1 cent steps)
3D	Damper	Layer 2 Damper Filter	DIS / ENA	Layer 2 damper disable/enable

- ▼ Layer 2 Program sets the program number for layer 2.
- ▼ Layer 2 Level sets the volume for layer 2. For a setting of 99 the volume will be the full volume as set by the Program parameter. A setting of 0 completely mutes the program.
- ▼ Layer 2 Panpot determines the output destination of layer 2. Details are the same as for Layer 1 Panpot.
- ▼ Layer 2 Interval is the pitch difference of layer 2 relative to layer 1 in semitones ( $\pm 2$  octaves).
- ▼ Layer 2 Detune is the pitch difference of layer 2 relative to layer 1 in steps of 1 cent ( $\pm 50$  cents). (100 cents is a semitone, and 1200 cents is one octave.)
- ▼ Layer 2 Damper Filter has the same effect as explained for Layer 1 Damper Filter.

## SPLIT type functions

Page		Editing parameter	Page reference
2A	SPLIT POINT	Split point	38
3A – 3C	LOWER PROG / LEVEL / PANPOT / DAMPER FILTER	Lower program number, output level, pan (output destination), and damper	38
4A – 4C	UPPER PROG / LEVEL / PANPOT / DAMPER FILTER	Upper program number, output level, pan (output destination), and damper	39

### 2A SPLIT POINT

2A SPLIT  
Point=C4

2A	SP	Split Point	C#-1 – G9	Split point setting
----	----	-------------	-----------	---------------------

▼ The Split Point determines the key which separates the two programs.

### 3A — 3C LOWER PROGRAM / LEVEL / PANPOT / DAMPER FILTER

3A LOWER  
100:Piano 16'

3B LOWER  
Level=99 Pan=5:5

3C LOWER  
Damper=ENA

3A		Lower Program	100 – 199 C00 – C99	The Program which will sound below the split point
3B	Level	Lower Level	0 – 99	Lower program level adjustment
	Pan	Lower Panpot	A, 9:1–1:9, B, C, C+D, D	Lower program output destination
3C	Damper	Lower Damper Filter	DIS/ENA	Lower program damper disable/enable

▼ Lower Program selects the program which will sound when a key lower than the split point is played.

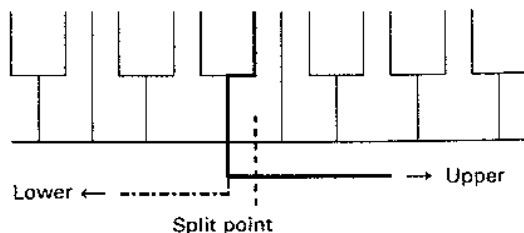

• The split point will be the lowest note of the upper side.

▼ Lower Level sets the level (volume) of the lower program. For a setting of 99 the volume will be the full volume as set by the Program parameter.

▼ Lower Panpot determines the output destination of the lower program. Select from A, A:B (9:1 to 1:9), B, C, C+D, and D.

• When a drum kit program is selected, the display will indicate "SND", and the pan settings of DRUM mode will be used. (This setting cannot be made here.)

▼ When Lower Damper Filter is set to "DIS" (disable), the damper pedal will not affect the lower program.

#### 4A — 4C UPPER PROGRAM / LEVEL / PANPOT / DAMPER FILTER

4A UPPER  
101:E. Piano 1

4B UPPER  
Level=99 Pan=5:5

4C UPPER  
Damper=ENA

4A		Upper Program	I00 – I99 C00 – C99	The Program which will sound above (or at) the split point
4B	Level	Upper Level	0 – 99	Upper program level adjustment
	Pan	Upper Panpot	A, 9:1–1:9, B, C, C+D, D	Upper program output destination
4C	Damper	Upper Damper Filter	DIS/ENA	Upper program damper disable/enable

▼ Upper Program selects the program which will sound when a key above (or at) the split point is played.

▼ Upper Level sets the level (volume) of the upper program. Details are the same as for Lower Level.

▼ Upper Panpot determines the output destination of the upper program. Details are the same as for Lower Panpot.

▼ Upper Damper Filter: details are the same as for Lower Damper Filter.

## Velocity Switch type functions

Page		Editing parameter	Page reference
2A	VELOCITY SW POINT	Velocity switch point	40
3A – 3C	SOFT PROG / LEVEL / PANPOT / DAMPER FILTER	Number, output level, output destination (pan), and damper for soft program.	40
4A – 4C	LOUD PROG / LEVEL / PANPOT / DAMPER FILTER	Number, output level, output destination (pan), and damper for loud program.	41

### 2A VELOCITY SWITCH POINT

2A VEL. SW  
Point=063

2A	Point	Vel. SW Point	2 – 127	Velocity value of velocity switch
----	-------	---------------	---------	-----------------------------------

- ▼ Vel. SW Point determines the velocity value which separates the two programs.

Example: a velocity switch point setting of 60

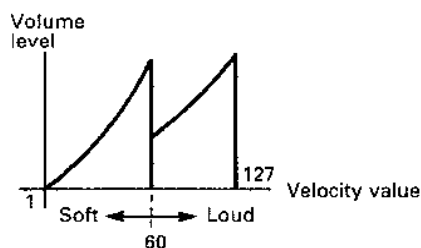

### 3A — 3C SOFT PROGRAM / LEVEL / PANPOT / DAMPER FILTER

3A SOFT  
100:Piano 16'

3B SOFT  
Level=99 Pan=5:5

3C SOFT  
Damper=ENA

3A		Soft Program	100 – 199 C00 – C99	The Program which will sound for notes played softer than the velocity switch point
3B	Level	Soft Level	0 – 99	Level adjustment of soft program
	Pan	Soft Panpot	A, 9:1 – 1:9, B, C, C+D, D	Output destination of soft program
3C	Damper	Soft Damper Filter	DIS/ENA	Disable/enable damper pedal for soft program

- ▼ Soft Program selects the program which will sound when the velocity value is less than (played softer than) the velocity switch point.
- ▼ Soft Level determines the level (volume) of the soft program. For a setting of 99 the volume will be the full volume as set by the Program parameter.
- ▼ Soft Panpot determines the output destination of the soft program. Select from A, A:B (9:1 to 1:9), B, C, C+D, and D.
  - When a drum kit program is selected, the display will indicate “SND”, and the pan settings of DRUMS mode will be used. (This setting cannot be made here.)
- ▼ When Soft Damper Filter is set to “DIS” (disable), the damper pedal will not affect the soft program.



#### 4A — 4C LOUD PROGRAM / LEVEL / PANPOT / DAMPER FILTER

4A LOUD 101:E. Piano 1	4B LOUD Level=99 Pan=5:5	4C LOUD Damper=ENA
---------------------------	-----------------------------	-----------------------

4A		Loud Program	100 – 199 C00 – C99	The Program which will sound for notes played stronger than the velocity switch point
4B	Level	Loud Level	0 – 99	Level adjustment of loud program
	Pan	Loud Panpot	A, 9:1 – 1:9, B, C, C+D, D	Output destination of loud program
4C	Damper	Loud Damper Filter	DIS/ENA	Disable/enable damper pedal for loud program

- ▼ Loud Program selects the program which will sound when the velocity value is greater (played more strongly) than the velocity switch point.
- ▼ Loud Level determines the level (volume) of the loud program. Details are the same as for Soft Level.
- ▼ Loud Panpot determines the output destination of the loud program. Details are the same as for Soft Panpot.
- ▼ Loud Damper Filter: details are the same as for Soft Damper Filter.

## Multi type functions

Page		Parameter to edit	Page reference
2A – 2B	PROGRAM SELECT	Program assigned to each timbre Level / pan (output destination)	42
3A – 3B	OUTPUT LEVEL	Output level of each timbre	43
4A – 4B	MIDI-CH	MIDI reception channel of each timbre	43
5A – 5D	KEY WINDOW TOP KEY WINDOW BOTTOM	Top key of each timbre's range Bottom key of each timbre's range	44
6A – 6D	VEL WINDOW TOP VEL WINDOW BOTTOM	Top velocity value of each timbre's velocity switch Bottom velocity value of each timbre's velocity switch	45
7A – 7D	KEY TRANSPOSE DETUNE	Key Transpose setting of each timbre Detune setting of each timbre	45
8A – 8D	MIDI PROG CHG DAMPER FILTER AFTER TOUCH CONTROL CHANGE	Program change receive filter for each timbre Damper receive filter for each timbre Aftertouch receive filter for each timbre Control change receive filter for each timbre	46
9A – 9B	PANPOT	Output destination of each timbre	47

### 2A — 2B PROGRAM SELECT

2A PROGRAM 1-4 OFF OFF OFF OFF	2B PROGRAM 5-8 OFF OFF OFF OFF
-----------------------------------	-----------------------------------

2A		Timbre 1 Program	OFF / 100 – 199, C00 – C99	Program selection for each timbre
		Timbre 2 Program	OFF / 100 – 199, C00 – C99	
		Timbre 3 Program	OFF / 100 – 199, C00 – C99	
		Timbre 4 Program	OFF / 100 – 199, C00 – C99	
2B		Timbre 5 Program	OFF / 100 – 199, C00 – C99	
		Timbre 6 Program	OFF / 100 – 199, C00 – C99	
		Timbre 7 Program	OFF / 100 – 199, C00 – C99	
		Timbre 8 Program	OFF / 100 – 199, C00 – C99	

▼ Select the Program used by each Timbre. Timbres set to "OFF" will not sound.

### 3A — 3B OUTPUT LEVEL

3A LEVEL 1-4	3B LEVEL 5-8
99 99 99 99	99 99 99 99

3A	Timbre 1 Level	0 – 99	Output level adjustment for each timbre
	Timbre 2 Level	0 – 99	
	Timbre 3 Level	0 – 99	
	Timbre 4 Level	0 – 99	
3B	Timbre 5 Level	0 – 99	
	Timbre 6 Level	0 – 99	
	Timbre 7 Level	0 – 99	
	Timbre 8 Level	0 – 99	

▼ OUTPUT LEVEL adjusts the output level of each timbre. At a setting of 99, the timbre will be at the full volume set by the program parameter. At a setting of 0, that timbre will not sound.

### 4A — 4B MIDI-CH (MIDI channel)

4A MIDI CH 1-4	4B MIDI CH 5-8
1G 1G 1G 1G	1G 1G 1G 1G

4A	Timbre 1 Channel	1 – 16	MIDI receive channel of each timbre
	Timbre 2 Channel	1 – 16	
	Timbre 3 Channel	1 – 16	
	Timbre 4 Channel	1 – 16	
4B	Timbre 5 Channel	1 – 16	
	Timbre 6 Channel	1 – 16	
	Timbre 7 Channel	1 – 16	
	Timbre 8 Channel	1 – 16	

▼ This determines the MIDI receive channel of each timbre. By setting a different MIDI receive channel for each timbre, multi-channel MIDI data received at MIDI IN can make the M3R play up to 8 sounds independently.

- MIDI program change, pitch bend, aftertouch, and control data will be received on the MIDI channel specified for each timbre. (It is also possible to set [8A] – [8D] so that these messages are not received.)

- When the reception channel specified for the timbre is the same as the global channel (the MIDI channel set in GLOBAL mode that controls the entire M3R), a “G” will be displayed after the channel number.
- Programs will be changed according to the MIDI channel set for each timbre, but when a program change arrives on the global channel, it will select a new combination. If you don’t want MIDI program change messages to select a new combination, set the global channel to a MIDI channel not used by a timbre.

## 5A — 5D KEY WINDOW TOP / BOTTOM

5A KW TOP 1-4  
G9 G9 G9 G9

5B KW TOP 5-8  
G9 G9 G9 G9

5C KW BTM 1-4  
C-1 C-1 C-1 C-1

5D KW BTM 5-8  
C-1 C-1 C-1 C-1

5A	Timbre 1 Top	C-1 - G9	Top key of the range sounded by each timbre
	Timbre 2 Top	C-1 - G9	
	Timbre 3 Top	C-1 - G9	
	Timbre 4 Top	C-1 - G9	
5B	Timbre 5 Top	C-1 - G9	
	Timbre 6 Top	C-1 - G9	
	Timbre 7 Top	C-1 - G9	
	Timbre 8 Top	C-1 - G9	
5C	Timbre 1 Bottom	C-1 - G9	Bottom key of the range sounded by each timbre
	Timbre 2 Bottom	C-1 - G9	
	Timbre 3 Bottom	C-1 - G9	
	Timbre 4 Bottom	C-1 - G9	
5D	Timbre 5 Bottom	C-1 - G9	
	Timbre 6 Bottom	C-1 - G9	
	Timbre 7 Bottom	C-1 - G9	
	Timbre 8 Bottom	C-1 - G9	

▼ Key Window determines the key area (key window) for which a timbre will sound. Notes outside this area will not be sounded by this timbre. This allows you to create a program which will sound different timbres for different areas of the keyboard.

- It is not possible to set a top key lower than the bottom key for a particular timbre. (If you set the top key lower than the bottom key, the bottom key will be adjusted to equal the top key, and vice versa.)

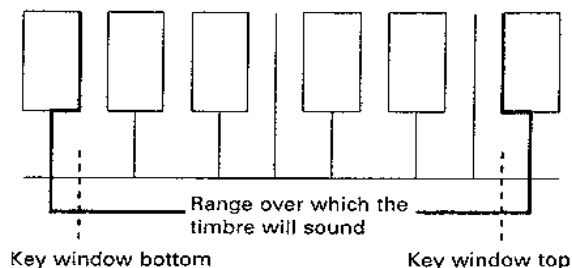

## 6A — 6D VEL WINDOW TOP / VEL WINDOW BOTTOM

6A VW TOP 1-4  
127 127 127 127

6B VW TOP 5-8  
127 127 127 127

6C VW BTM 1-4  
001 001 001 001

6D VW BTM 5-8  
001 001 001 001

6A	Timbre 1 Top	1 - 127	Top value of velocity range sounded by each timbre
	Timbre 2 Top	1 - 127	
	Timbre 3 Top	1 - 127	
	Timbre 4 Top	1 - 127	
6B	Timbre 5 Top	1 - 127	
	Timbre 6 Top	1 - 127	
	Timbre 7 Top	1 - 127	
	Timbre 8 Top	1 - 127	
6C	Timbre 1 Bottom	1 - 127	Bottom value of velocity range sounded by each timbre
	Timbre 2 Bottom	1 - 127	
	Timbre 3 Bottom	1 - 127	
	Timbre 4 Bottom	1 - 127	
6D	Timbre 5 Bottom	1 - 127	
	Timbre 6 Bottom	1 - 127	
	Timbre 7 Bottom	1 - 127	
	Timbre 8 Bottom	1 - 127	

- ▼ Velocity Window determines the velocity (playing strength) range for which a timbre will sound. This allows you to create a program which will sound different timbres for notes played with differing velocities.
  - It is not possible to set a top value lower than the bottom value.

- Example : velocity window bottom = 25, velocity window top = 100

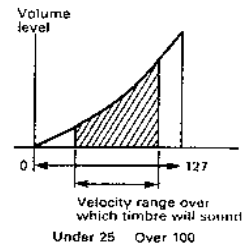

## 7A — 7D KEY TRANSPOSE / DETUNE

7A TRANS 1-4  
+00 +00 +00 +00

7B TRANS 5-8  
+00 +00 +00 +00

7C DETUNE 1-4  
+00 +00 +00 +00

7D DETUNE 5-8  
+00 +00 +00 +00

7A	Timbre 1 Transpose	-24 - +24	Transpose setting of each timbre in semitones ( $\pm 2$ octaves)
	Timbre 2 Transpose	-24 - +24	
	Timbre 3 Transpose	-24 - +24	
	Timbre 4 Transpose	-24 - +24	
7B	Timbre 5 Transpose	-24 - +24	
	Timbre 6 Transpose	-24 - +24	
	Timbre 7 Transpose	-24 - +24	
	Timbre 8 Transpose	-24 - +24	
7C	Timbre 1 Detune	-50 - +50	Detune setting of each timbre in 1 cent steps ( $\pm 50$ cents)
	Timbre 2 Detune	-50 - +50	
	Timbre 3 Detune	-50 - +50	
	Timbre 4 Detune	-50 - +50	
7D	Timbre 5 Detune	-50 - +50	
	Timbre 6 Detune	-50 - +50	
	Timbre 7 Detune	-50 - +50	
	Timbre 8 Detune	-50 - +50	

- Transpose adjusts the pitch of each timbre in semitones over a range of -24 to +24 (12 is one octave).

- ▼ Detune adjusts the pitch of each timbre in fine steps of one cent, over a range of -50 to +50 (100 cents is a semitone).

## 8A — 8D MIDI FILTER

8A PROG CHANGE E E E E E E E E	8B DAMPER E E E E E E E E	8C AFTER TOUCH E E E E E E E E	8D CONTROL CHG E E E E E E E E
-----------------------------------	------------------------------	-----------------------------------	-----------------------------------

8A	Timbre 1 Prog change	D/E	Determine whether or not each timbre will receive MIDI program changes ("D" disables reception)
	Timbre 2 Prog change	D/E	
	Timbre 3 Prog change	D/E	
	Timbre 4 Prog change	D/E	
	Timbre 5 Prog change	D/E	
	Timbre 6 Prog change	D/E	
	Timbre 7 Prog change	D/E	
	Timbre 8 Prog change	D/E	
8B	Timbre 1 Damper	D/E	Determine whether or not each timbre will receive MIDI damper pedal ("D" disables reception)
	Timbre 2 Damper	D/E	
	Timbre 3 Damper	D/E	
	Timbre 4 Damper	D/E	
	Timbre 5 Damper	D/E	
	Timbre 6 Damper	D/E	
	Timbre 7 Damper	D/E	
	Timbre 8 Damper	D/E	
8C	Timbre 1 After Touch	D/E	Determine whether or not each timbre will receive MIDI aftertouch ("D" disables reception)
	Timbre 2 After Touch	D/E	
	Timbre 3 After Touch	D/E	
	Timbre 4 After Touch	D/E	
	Timbre 5 After Touch	D/E	
	Timbre 6 After Touch	D/E	
	Timbre 7 After Touch	D/E	
	Timbre 8 After Touch	D/E	
8D	Timbre 1 Control CHG	D/E	Determine whether or not each timbre will receive MIDI control changes ("D" disables reception)
	Timbre 2 Control CHG	D/E	
	Timbre 3 Control CHG	D/E	
	Timbre 4 Control CHG	D/E	
	Timbre 5 Control CHG	D/E	
	Timbre 6 Control CHG	D/E	
	Timbre 7 Control CHG	D/E	
	Timbre 8 Control CHG	D/E	

▼ Timbres whose MIDI Prog Change is set to "D" will not switch programs when a MIDI program change is received.

- If a program change is received on the global channel, the Combination will change regardless of this setting.

▼ Timbres whose Damper is set to "D" will not be affected by the damper pedal.

▼ Timbres whose Aftertouch is set to "D" will not be affected by aftertouch.

▼ Timbres whose Control Change is set to "D" will not be affected by control changes (bender, pitch modulation, VDF modulation, volume).

## 9A — 9B PANPOT

9A PANPOT 1-4  
 5:5 5:5 5:5

9B PANPOT 5-8  
 5:5 5:5 5:5 5:5

9A	Timbre 1 Panpot	A, 9:1-1:9, B, C, C+D, D	Output destination for each timbre
	Timbre 2 Panpot	A, 9:1-1:9, B, C, C+D, D	
	Timbre 3 Panpot	A, 9:1-1:9, B, C, C+D, D	
	Timbre 4 Panpot	A, 9:1-1:9, B, C, C+D, D	
	Timbre 5 Panpot	A, 9:1-1:9, B, C, C+D, D	
	Timbre 6 Panpot	A, 9:1-1:9, B, C, C+D, D	
	Timbre 7 Panpot	A, 9:1-1:9, B, C, C+D, D	
	Timbre 8 Panpot	A, 9:1-1:9, B, C, C+D, D	

- ▼ Panpot assigns the output of each timbre to outputs A – D. Select the output for each timbre from A, A:B (9:1 – 1:9), B, C, C+D, D.

- If a drum kit program is assigned, the display will show “SND”, and the pan settings of DRUMS mode will be used. (This setting cannot be made here.)

## 4. EFFECT MODE

To enter this mode

			②
①			

①②=press the keys in this order.

Key functions

PLAY	PAGE+	▷	△/YES
EDIT	PAGE-	◁	▽/NO

= Keys whose indicators light when in this mode

The M3R has two built-in digital effects devices, each with two outputs. Each effects device can produce effects such as reverb, delay, chorus, flanger, phase shifter, distortion, exciter, etc. Individual parameters can also be adjusted for each effect.

Effect settings can also be made for each combination.

- Since each combination has its own effect settings, effects settings will change when you select a different combination.

- It is also possible to make settings so that a different effect is used only by a specific sound in a combination or drum kit program.

The effects section consists of four inputs (A, B, C, D), and outputs (1/L, 2/R, 3, 4), with two effects and two panpots. The two effects can be placed in series or in parallel. Signals are converted from digital to analog only after passing through the effects section.

- If the GLOBAL mode Page Memory function is On, the parameter you last selected before exiting this mode will automatically appear.
- In this mode, you will always hear the sound with the effect applied, even if the GLOBAL mode Effect Interlock function is Off.

### Effect placement

#### Serial placement

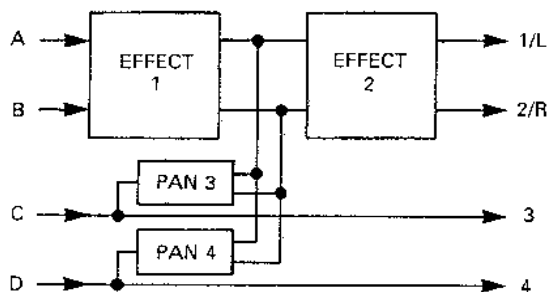

When the two effects are placed in series, inputs A and B will be processed through effect 1 and effect 2, and sent from outputs 1/L and 2/R. Outputs 3 and 4 carry the unmodified signal from C and D. The output signals 3 and 4 can also be assigned to the two inputs of effect 2.

- ☆ It is possible to use inputs C and D so that only specified programs are processed through effect 1, while all programs are processed through effect 2.



## Parallel placement

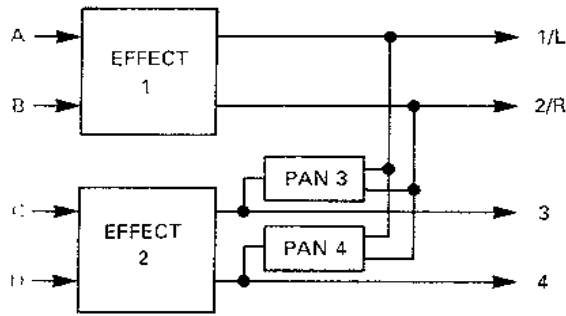

When the two effects are placed in parallel, inputs A, B and C, D will be processed through different effects, and sent from outputs 1/L, 2/R and 3, 4. The outputs 3, 4 can also be mixed into the outputs 1/L, 2/R.

There are two types of effect; stereo effects (1–25) and dual effects in which each channel has a different effect (26–33).

The input to A–D is determined by the pan settings in COMBINATION EDIT mode. However if a drum kit is used, the settings made in DRUMS mode will have priority.

Output 3 pan and output 4 pan can be used in the following ways;

- When different sounds are input at C and D, output 3 pan and output 4 pan can mix these sounds into the stereo output.
- When effects are placed in parallel and stereo-type effects are selected for effects 1/2, by sending output 3 to L and output 4 to R, you can get a stereo mix of effects 1 and 2.
- If an external mixer or effects device is connected, you can set output 3 pan and output 4 pan to “OFF”, and use outputs 3/4 as separate outputs.

## OC EFFECT 1

EFFECT1=01 OFF	0B Hall DRY:EFF=60:40	0C Delay DRY:EFF=60:40
-------------------	--------------------------	---------------------------

EFFECT TYPE	01 – 33 34:No Effect	Select the type of effect No effect is used
SWITCH	OFF / ON	Effect ON/OFF
DRY:EFF Balance	DRY, 99:1 – 1:99, EFF	The output balance of the direct sound and processed sound.
DRY:EFF Balance	DRY, 99:1 – 1:99, EFF	The output balance of the direct sound and the processed sound (used for types 26 and above)

A) select the type of effect.

When you select the effect type, the effect parameters will be set to their initial setting (see page 67).

Dual-type effect #24 Symphonic Ensemble or #25 Dual Speaker has been selected for one of the two effect devices, there will be some effect types which cannot be selected for the other effects device.

Effect number of “-” will be displayed for such effect types. If these effect types are already selected for one effects device, effect types 24 and 25 cannot be selected for the other effects device. (See page 67.)

▼ When you select a combination, settings will be set to match the effect parameter settings of that combination.

☆ For effects other than Reverb (01–06), Early Reflection (07–09), Overdrive (21, 22), and Ensemble (24), the equalizer settings (LOW EQ and HIGH EQ) will be effective even when the effect switch is “OFF”.

To turn off an effect including its equalizer settings (for example while editing a sound), select “34:No Effect” as the effect type.

## 1A – 1C EFFECT 1 PARAMETERS

- These set the parameters for effect 1.
  - Parameter details will differ according to the parameter type. Refer to the explanation of parameter types

- These settings will be initialized whenever the effect type of effect 1 is changed.

## 2A — 2C EFFECT 2

- ▼ Select the effect type for effect 2.
  - Details are the same as [0A] – [0C] EFFECT 1.

## 3A – 3C EFFECT 2 PARAMETERS

- ▼ These set the parameters for effect 2.
  - Details are the same as for [1A] – [1D] EFFECT 1 PARAMETERS.

## 4A – 4B EFFECT PLACEMENT

4A PLACEMENT Serial	4B EFF2 PANPOT 3= L 4= R
------------------------	-----------------------------

4A		Effect Placement	Parallel Serial	Select effect placement: Effects placed in parallel Effects placed in series
4B	3	Out3 Panpot	OFF, R; 01:99 – 99:01, L	Output 3 pan is not used (OFF), output 3 pan setting (L:R)
	4	Out4 Panpot	OFF, R; 01:99 – 99:01, L	Output 4 pan is not used (OFF), output 4 pan setting (L:R)

- ▼ These parameters determine how the two effects devices are placed, and the pan setting of outputs 3 and 4.

Parameters 1A — 1D, 3A — 3D will differ according to the effect type. Refer to the explanation for the selected type of effect. The displays show the initial settings for each type of effect.

## Reverb group

These effects simulate reverberation, adding ambience to a sound.

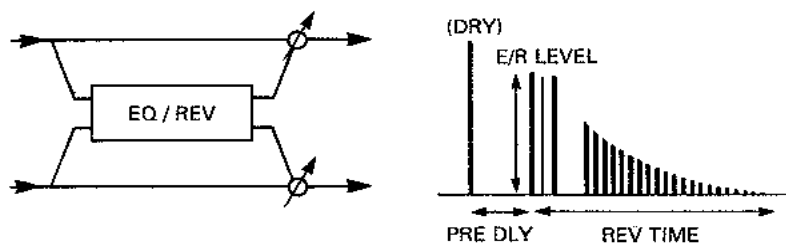

### 1. HALL

The effect of a natural-sounding hall.

### 2. ENSEMBLE HALL

Hall-type reverb suitable for an ensemble of string or brass sounds.

### 3. CONCERT HALL

The ambience of a fairly large hall, with emphasis on the early reflections.

### 4. ROOM

The ambience of a fairly small room.

### 5. LARGE ROOM

Room-type reverb with emphasis on the sound density. Setting a REVERB TIME of 0.5 seconds will produce a gated-type effect.

### 6. LIVE STAGE

The reverberation characteristic of a fairly large room.

1A Hall  
Time: 3.5s H.Dmp40

1B Hall  
P.Dly055ms E/R46

1C Hall  
EQ: L-05dB H+00dB

1A	Time	Reverb Time	0.2 – 9.9 [sec] (HALL-type) 0.2 – 4.9 [sec] (ROOM-type)	Time required for reverberation to decay
	H.Dmp	High Damp	0 – 99 [%]	Higher settings will result in more rapid high-frequency damping
1B	P.Dly	Pre-delay	0 – 200 [ms]	Time delay between the direct sound and the first reverberant sound
	E/R	Early Ref	0 – 99	Level of early reflections
1C	EQ.L	EQ Low	-12 – +12 [dB]	Low frequency cut or boost
	H	EQ High	-12 – +12 [dB]	High frequency cut or boost

## Early Reflection group

Early reflections are the acoustic reflections that precede the reverberant “wash”, and are an important psychoacoustic cue in determining the shape and size of the reverberant space. Adjusting the E/R time lets you achieve a wide range of effects, such as thickening the sound, or adding echo-like reflections.

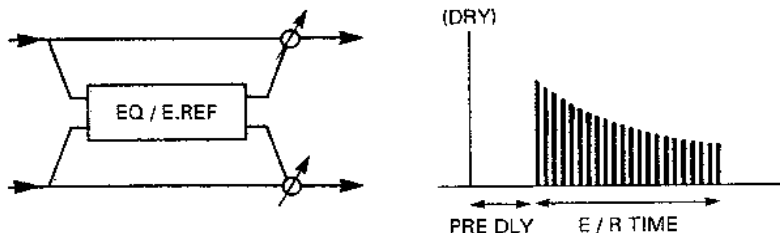

### 7. EARLY REFLECTION I

This is effective for strengthening the low frequency range, or as a general- purpose gating effect for drums.

### 8. EARLY REFLECTION II

The early reflection time affects the level in a different way than E/R I, and provides an effect useful on various sounds.

### 9. EARLY REFLECTION III

This has an early reflection envelope that is the reverse of E/R I and E/R II. When used on sounds with a pronounced attack, such as cymbals, it provides a reverse effect.

1A Early Ref I  
Time 170ms D030ms

1B Early Ref I  
EQ. L+00dB H+00dB

1A 3A	Time	E/R Time	100 – 800 [mS]	Early reflection time
	D	Pre Delay	2 – 200 [mS]	Time delay between the direct sound and the first early reflection
1B 3B	EQ.L	EQ Low	-12 – +12 [dB]	Low frequency cut or boost
	H	EQ High	-12 – +12 [dB]	High frequency cut or boost

## Delay group

These effects can be given independent delay times for L and R outputs, for a stereo delay. The high damp setting can be used to damp the high frequencies, creating a more natural simulation of actual acoustic decay.

### 10. STEREO DELAY

This stereo effect consists of two delays. Parameters other than delay time are common to both delays.

### 11. CROSS DELAY

A stereo delay in which the delayed signal of each delay crosses over and is fed back to the other delay.

#### • STEREO DELAY

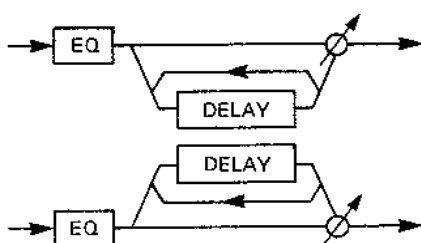

#### • CROSS DELAY

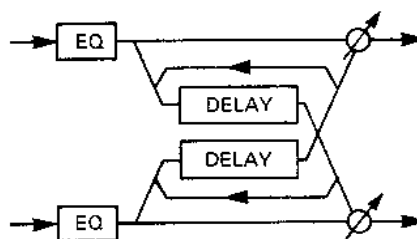

1A Stereo DLY  
DT L250ms R280ms

1B Stereo DLY  
FB+50 H.Dmp10

1C Stereo DLY  
EQ. L+00dB H+00dB

1A 3A	DT L	Delay Time Left	0 – 500 [mS]	Delay between direct and processed sound of the left channel (input A or C)
	R	Delay Time Right	0 – 500 [mS]	Delay between direct and processed sound of the right channel (input B or D)
1B 3B	FB	Feedback	-99 – +99 [%]	Amount of feedback (negative settings produce inverted phase)
	H.Dmp	High Damp	0 – 99 [%]	Higher settings result in more rapid high frequency damping
1C 3C	EQ.L	EQ Low	-12 – +12 [dB]	Low frequency cut or boost
	H	EQ High	-12 – +12 [dB]	High frequency cut or boost

## Chorus group

These stereo effects combine two chorus circuits, to provide natural spaciousness and depth for piano, strings, brass, or any other sound.

### 12. STEREO CHORUS I

Modulation is applied to two chorus units so that they are in reversed phase, resulting in an effect of swirling stereo movement.

### 13. STEREO CHORUS II

Modulation of the same phase is applied to the two chorus circuits.

• STEREO CHORUS I

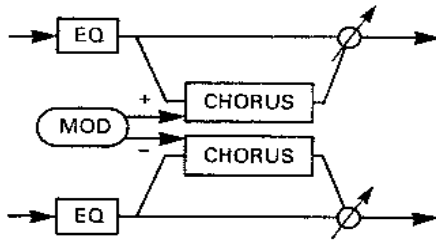

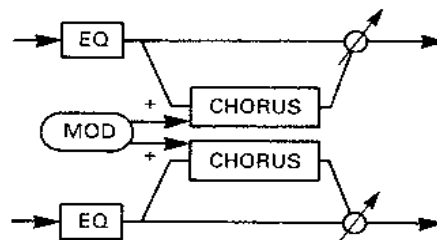

• STEREO CHORUS II



1A Chorus 1  
Mod60 0.30Hz TRI

1B Chorus 1  
Time010ms

1C Chorus 1  
EQ. L+00dB H+00dB

1A 3A	Mod	Mod Depth	0 – 99	Modulation depth
		Mod Speed	0.03 – 30[Hz]	Modulation speed (frequency)
		Mod Waveform	SIN TRI	Modulation waveform Sine wave  Triangle wave 
1B 3B	Time	Delay Time	0 – 200[mS]	Delay between direct sound and processed sound
1C 3C	EQ.L	EQ Low	-12 – +12[dB]	Low frequency cut or boost
	H	EQ High	-12 – +12[dB]	High frequency cut or boost

## Flanger group

This adds feedback to the chorus effect. When used on sounds that have many harmonics, such as cymbals, it adds a swirling sound with a feeling of pitched tone color.

### 14. STEREO FLANGER

This stereo effect uses two flanging circuits, modulated to be in opposite phase for a swirling stereo movement.

### 15. CROSS FLANGER

This is an effect which is used to cross-feed the feedback of two flanger blocks to each other.

#### • STEREO FLANGER

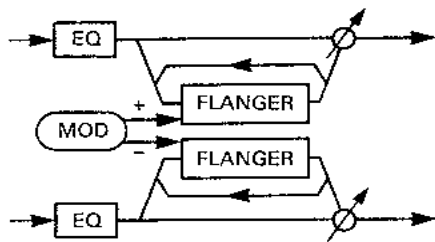

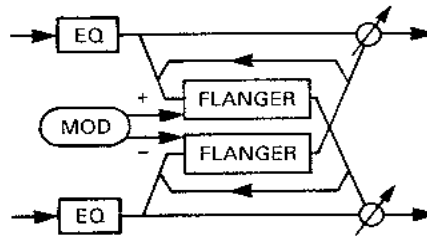

#### • CROSS FLANGER



1A Flanger  
Mod70 0.18Hz SIN

1B Flanger  
Time00ms FB-75

1C Flanger  
EQ.L+00dB H+00dB

1A	Mod	Mod Depth	0 - 99	Depth of flanging effect
		Mod Speed	0.03 - 30[Hz]	Modulation speed (frequency)
		Mod Waveform	SIN TRI	Modulation waveform Sine wave  Triangle wave 
1B	Time	Delay Time	0 - 50[mS]	Delay between direct sound and processed sound
	FB	Feedback	-99 - +99[%]	Amount of feedback (negative settings produce inverted phase)
1C	EQ.L	EQ Low	-12 - +12[dB]	Low frequency cut or boost
	H	EQ High	-12 - +12[dB]	High frequency cut or boost

## Phase Shifter group

In contrast to the chorus and flanger, which modulate the time delay to create a swirling effect, a phaser modulates the phase of the input signal to produce an effect differing from chorus or flanging. It is especially effective when used on electric piano or guitar sounds.

### 16. PHASER I

This stereo effect uses two phaser circuits, modulated in opposite phase to produce a swirling effect of stereo movement.

### 17. PHASER II

The two phaser circuits are modulated in phase.

- PHASER I

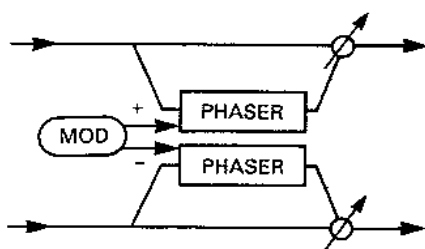

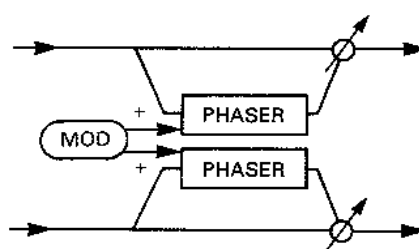

- PHASER II



1A Phaser 1  
Manual 199 FB-75

1B Phaser 1  
Mod 60 0.69Hz SIN

1A 3A	Manual	Manual	0 - 99	Center frequency affected by the phase shift
	FB	Feedback	-99 - +99[%]	Amount of feedback (negative settings produce inverted phase)
1B 3B	Mod	Mod Depth	0 - 99	Depth of phase shift effect
		Mod Speed	0.03 - 30[Hz]	Modulation speed (frequency)
		Mod-Waveform	SIN TRI	Modulation waveform Sine wave  Triangle wave 



## Tremolo group

This effect periodically varies the volume.

### 18. STEREO TREMOLO I

This stereo effect uses two tremolo circuits, modulated in reverse phase to produce an effect of stereo panning.

### 19. STEREO TREMOLO II

In contrast to the above Stereo Tremolo I, this effect modulates the two tremolo circuits in phase.

• STEREO TREMOLO I

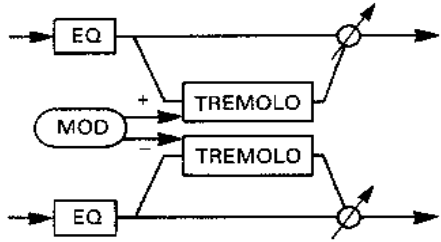

• STEREO TREMOLO II

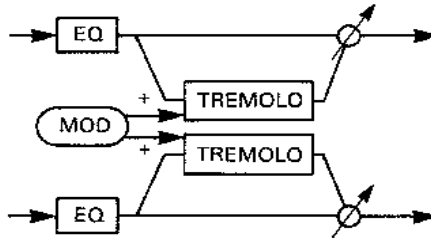

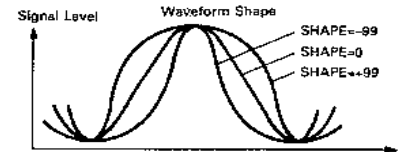

• Shape



1A Tremolo 1  
Mod80 1.59Hz SIN

1B Tremolo 1  
Shape+99

1C Tremolo 1  
EQ.L+00dB H+00dB

1A 3A	Mod	Mod Depth	0 - 99	Depth of tremolo effect
		Mod Speed	0.03 - 30[Hz]	Modulation speed (frequency)
		Mod Waveform	SIN TRI	Modulation waveform Sine wave  Triangle wave 
1B 3B	Shape	Shape	-99 - +99	Modify the shape of the modulation waveform
1C 3C	EQ.L	EQ Low	-12 - +12[dB]	Low frequency cut or boost
	H	EQ High	-12 - +12[dB]	High frequency cut or boost

## Equalizer group

### 20. EQUALIZER

This is a two-band equalizer with adjustable cutoff frequency and gain for high and low bands.

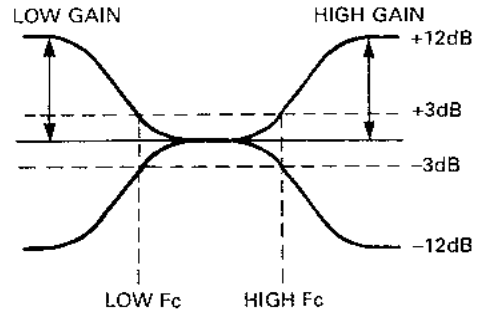
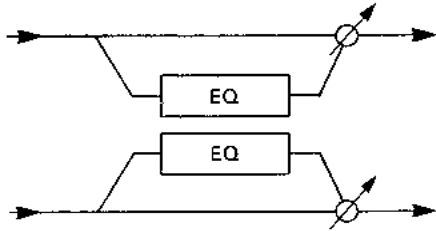

1A Equalizer	1B Equalizer
Low+00dB 500Hz	High+00dB 2KHz

1A 3A	Low	Low Gain	-12 - +12[dB]	Cut or boost for low frequency band
		Low Fc	250/500/1K[Hz]	Cutoff frequency for low frequency band
1B 3B	High	High Gain	-12 - +12[dB]	Cut or boost for high frequency band
		High Fc	1K/2K/4K[Hz]	Cutoff frequency for high frequency band

## Overdrive group

### 21. OVER DRIVE

This effect simulates the overdrive often used by electric guitars. It is especially effective when playing guitar-like lines and solos, or rock organ sounds.

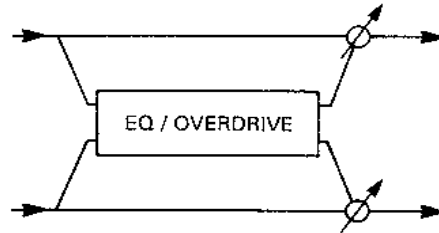

1A Over Drive  
Drive080 Lev015

1B Over Drive  
EQ. L+00dB H+00dB

1A 3A	Drive	Drive	0 – 100	Overdrive of input signal
	Lev	Level	0 – 100	Output level of processed sound
1B 3B	EQ.L	EQ Low	-12 – +12[dB]	Low frequency range cut or boost
	H	EQ High	-12 – +12[dB]	High frequency range cut or boost

### 22. DISTORTION

This has a more distorted sound than overdrive, and simulates a fuzz-type distortion device. It is especially effective for solos.

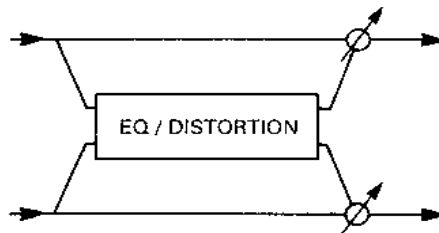

1A Distortion  
Dist080 Lev020

1B Distortion  
EQ. Low+00dB

1A 3A	Dist	Distortion	0 – 100	Distortion of input signal
	Lev	Level	0 – 100	Output level of processed sound
1B 3B	EQ.Low	EQ Low	-12 – +12[dB]	Low frequency range cut or boost

**Exciter group**

**23. EXCITER**

This effect increases the clarity of the sound, gives it greater definition and presence, and helps bring the sound to the forefront.

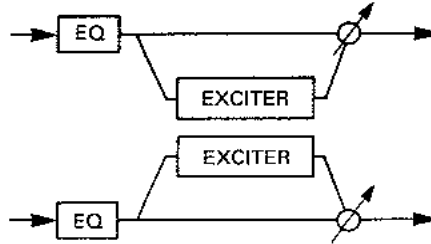

1A Exciter  
Blend+99 Point05

1B Exciter  
EQ.L+00dB H+00dB

1A 3A	Blend	Blend	-99 - +99	Depth of the exciter effect
	Point	Emphatic Point	1 - 10	Center frequency to which exciter effect is applied
1B 3B	EQ.L	EQ Low	-12 - +12[dB]	Low frequency range cut or boost
	H	EQ High	-12 - +12[dB]	High frequency range cut or boost

**Ensemble group**

**24. SYMPHONIC ENSEMBLE**

This effect uses multi-level chorusing, and is especially effective for string ensemble sounds.

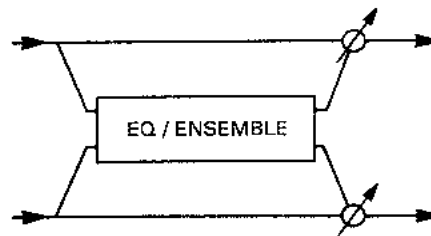

1A Sympho Ens  
Mod80

1B Sympho Ens  
EQ.L+00dB H+00dB

1A 3A	Mod	Mod Depth	0 - 99	Depth of the ensemble effect
1B 3B	EQ.L	EQ Low	-12 - +12[dB]	Low frequency cut or boost
	H	EQ High	-12 - +12[dB]	High frequency cut or boost

## Rotary effect group

### 25. ROTARY SPEAKER

This simulates the effect of a rotary speaker often used with electric organs, and is very effective when used on organ sounds. The rotational speed of the speaker can be controlled using a MIDI control change (Bn.50.dd).

- \* In this case the control change acts as a switch (dd= 0-3Fh:slow, 40h-7Fh:fast), and the speed has no relation to how fast the MIDI data changes. (Even if you advance the pedal slowly, this will not affect how the speed changes.)
- \* The volume pedal control for the **M1/MIR** rotary effect is not transmitted via MIDI.

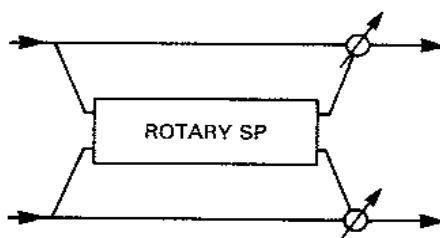

1A Rotary SP  
Mod62 FAST

1B Rotary SP  
Ratio+05

1A 3A	Mod	Mod Depth	0 - 99	Depth of the effect
		Speed	Slow/Fast	Rotation speed of the low frequency speaker
1B 3B	Ratio	Speed Ratio	-20 - +20	Ratio of the high frequency speaker rotation speed in relation to the low frequency speaker rotation speed

## Combination type effect group

Effect types 26 through 33 are combinations in which two different effects are available on one effect generator. This allows you to use each of effects 1/2 as two independent effects.

- **Example:** Parallel placement with 26: DELAY/HALL selected for effect 1, and 31: DELAY/FLANGER selected for effect 2.

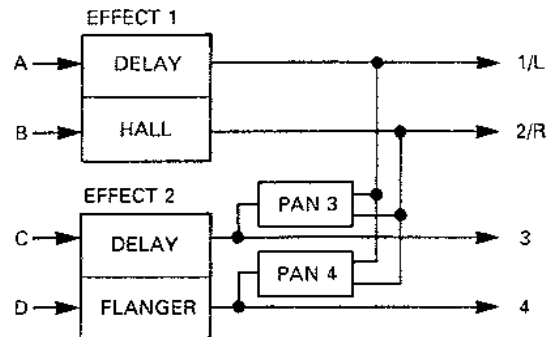

- Consult the explanations for 1 to 19 for details of each effect.
- Effect balance is set by [0B] for the (L) effect and by [0C] for the (R) effect.
- Parameters [1A], [1B] ([3A], [3B]) apply to the (L) effect. Parameters [1C], [1D] ([3C], [3D]) apply to the (R) effect.

### 26. DELAY / HALL

1A Delay(L) Time250ms FB+50	1B Delay(L) H. Dmp10	1C Hall(R) Time3.5s H. Dmp40	1D Hall(R) P. Dly055ms
--------------------------------	-------------------------	---------------------------------	---------------------------

#### DELAY

1A 3A	Time	Delay Time	0 – 500 [mS]	Time between direct sound and delayed sound
	FB	Feedback	-99 – +99 [%]	Amount of feedback (negative settings produce inverted phase)
1B 3B	H.Dmp	High Damp	-0 – +99 [%]	Higher settings make the high frequencies decay faster

#### HALL

1C 3C	Time	Reverb Time	0.2 – 9.9 [sec]	Time required for reverb to decay
	H.Dmp	High Damp	0 – 99 [%]	Higher settings make the high frequencies decay faster
1D 3D	P.Dly	Pre Delay	0 – 150 [mS]	Time delay between direct sound and reverberant sound

## 27. DELAY / ROOM

1A Delay(L)  
Time250ms FB+50

1B Delay(L)  
H. Dmp10

1C Room(R)  
Time1.5s H. Dmp30

1D Room(R)  
P. Dly030ms

### DELAY

1A 3A	Time	Delay Time	0 - 500 [mS]	Time between direct sound and delayed sound
	FB	Feedback	-99 - +99 [%]	Amount of feedback (negative settings produce inverted phase)
1B 3B	H.Dmp	High Damp	0 - 99 [%]	Higher settings make the high frequencies decay faster

### ROOM

1C 3C	Time	Reverb Time	0.2 - 4.9 [sec]	Time required for reverb to decay
	H.Dmp	High Damp	0 - 99 [%]	Higher settings make the high frequencies decay faster
1D 3D	P.Dly	Pre Delay	0 - 150 [mS]	Time delay between direct sound and reverberant sound

## 28. DELAY / EARLY REFLECTION

1A Delay(L)  
Time250ms FB+50

1B Delay(L)  
H. Dmp10

1C E. Ref(R)  
Time200ms D030ms

### DELAY

1A 3A	Time	Delay Time	0 - 500 [mS]	Time between direct sound and delayed sound
	FB	Feedback	-99 - +99 [%]	Amount of feedback (negative settings produce inverted phase)
1B 3B	H.Dmp	High Damp	0 - 99 [%]	Higher settings make the high frequencies decay faster

### EARLY REFLECTION

1C 3C	Time	E/R Time	100 - 400 [mS]	Early reflection time
	D	Pre Delay	0 - 100 [mS]	Time delay between direct sound and early reflections

## 29. DELAY / DELAY

1A Delay(L)  
Time250ms FB+50

1B Delay(L)  
H. Dmp10

1C Delay(R)  
Time250ms FB+50

1D Delay(R)  
H. Dmp10

### DELAY

1A 3A	Time	Delay Time	0 – 500 [mS]	Time between direct sound and delayed sound
	FB	Feedback	-99 – +99 [%]	Amount of feedback (negative settings produce inverted phase)
1B 3B	H.Dmp	High Damp	0 – 99 [%]	Higher settings make the high frequencies decay faster

### DELAY

1C 3C	Time	Delay Time	0 – 500 [mS]	Time between direct sound and delayed sound
	FB	Feedback	-99 – +99 [%]	Amount of feedback (negative settings produce inverted phase)
1D 3D	H.Dmp	High Damp	0 – 99 [%]	Higher settings make the high frequencies decay faster

## 30. DELAY / CHORUS

1A Delay(L)  
Time250ms FB+50

1B Delay(L)  
H. Dmp10



1C Chorus(R)  
Mod60 0.30Hz

1D Chorus(R)  
TRI

### DELAY

1A 3A	Time	Delay Time	0 – 500 [mS]	Time between direct sound and delayed sound
	FB	Feedback	-99 – +99 [%]	Amount of feedback (negative settings produce inverted phase)
1B 3B	H.Dmp	High Damp	0 – 99 [%]	Higher settings make the high frequencies decay faster

### CHORUS

1C 3C	Mod	Mod Depth	0 – 99	Depth of chorus effect
		Mod Speed	0.03 – 30 [Hz]	Modulation speed (frequency)
1D 3D		Mod Waveform	SIN TRI	Waveform selection Sine wave  Triangle wave 



### 31. DELAY / FLANGER

1A Delay(L)  
Time250ms FB+50

1B Delay(L)  
H. Dmp10

1C Flanger(R)  
Mod70 0.18Hz

1D Flanger(R)  
FB-75

#### DELAY

1A 3A	Time	Delay Time	0 - 500 [mS]	Time between direct sound and delayed sound
	FB	Feedback	-99 - +99 [%]	Amount of feedback (negative settings produce inverted phase)
1B 3B	H.Dmp	High Damp	0 - 99 [%]	Higher settings make the high frequencies decay faster

#### FLANGER

1C 3C	Mod	Mod Depth	0 - 99	Depth of flanging effect
		Mod Speed	0.03 - 30 [Hz]	Modulation speed (frequency)
1D 3D	FB	Feedback	-99 - +99 [%]	Amount of feedback (negative settings produce inverted phase)

### 32. DELAY / PHASER

1A Delay(L)  
Time250ms FB+50

1B Delay(L)  
H. Dmp10

1C Phaser(R)  
Mod60 0.69Hz

1D Phaser(R)  
FB-75

#### DELAY

1A 3A	Time	Delay Time	0 - 500 [mS]	Time between direct sound and delayed sound
	FB	Feedback	-99 - +99 [%]	Amount of feedback (negative settings produce inverted phase)
1B 3B	H.Dmp	High Damp	0 - 99 [%]	Higher settings make the high frequencies decay faster

#### PHASER

1C 3C	Mod	Mod Depth	0 - 99	Depth of phase shift effect
		Mod Speed	0.03 - 30 [Hz]	Modulation speed (frequency)
1D 3D	FB	Feedback	-99 - +99 [%]	Amount of feedback (negative settings produce inverted phase)

### 33. DELAY / TREMOLO

1A Delay(L)  
Time250ms FB+50

1B Delay(L)  
H.Dmp10

1C Tremolo(R)  
Mod80 1: 59Hz

1D Tremolo(R)  
Shape+00

#### DELAY

1A 3A	Time	Delay Time	0 - 500 [mS]	Time between direct sound and delayed sound
	FB	Feedback	-99 - +99 [%]	Amount of feedback (negative settings produce inverted phase)
1B 3B	H.Dmp	High Damp	0 - 99 [%]	Higher settings make the high frequencies decay faster

#### TREMOLO

1C 3C	Mod	Mod Depth	0 - 99	Depth of tremolo effect
		Mod Speed	0.03 - 30 [Hz]	Modulation speed (frequency)
1D 3D	Shape	Shape	-99 - +99 [%]	Change in shape of modulating wave (sine wave)

## EFFECT PARAMETERS DEFAULT VALUES CHART

NO	EFFECT	OB	OC	1A/3A	▷	▷	◁	1B/3B	▷
		D:E		REVERB TIME	HIGH DAMP			PRE DELAY	
01	HALL	60:40		3.5S	40%			55mS	
02	ENSEMBLE HALL	60:40		2.8S	40%			30mS	
03	CONCERT HALL	60:40		3.8S	40%			120mS	
04	ROOM	40:60		0.5S	10%			22mS	
05	LARGE ROOM	60:40		1.5S	30%			30mS	
06	LIVE STAGE	60:40		2.0S	20%			20mS	
		D:E		E/R TIME	PRE DELAY			EQ LOW	
07	EARLY REF 1	60:40		170mS	30mS			0dB	
08	EARLY REF 2	60:40		200mS	20mS			0dB	
09	EARLY REF 3	60:40		190mS	10mS			0dB	
		D:E		DELAY TIME L	DELAY TIME R			FEEDBACK	
10	STEREO DELAY	70:30		250mS	260mS			+50%	
11	CROSS DELAY	70:30		180mS	360mS			+80%	
		D:E		MOD DEPTH	SPEED		WAVEFORM	DELAY TIME	
12	STEREO CHO 1 *	60:40		60	0.30Hz		TRI	10mS	
13	STEREO CHO 2 *	60:40		20	2.40Hz		SIN	5mS	
		D:E		MOD DEPTH	SPEED		WAVEFORM	DELAY TIME	
14	STEREO FLNG *	40:60		70	0.18Hz		SIN	0mS	
15	CROSS FLNG *	25:75		37	0.21Hz		SIN	25mS	
		D:E		MANUAL	FEEDBACK			MOD DEPTH	
16	PHASER 1 *	25:75		99	-75%			60	
17	PHASER 2 *	60:40		99	+87%			69	
		D:E		MOD DEPTH	SPEED		WAVEFORM	SHAPE	
18	STEREO TREM 1 *	EFF		80	1.59Hz		SIN	+99	
19	STEREO TREM 2 *	EFF		63	4.00Hz		TRI	0	
		D:E		LOW GAIN	LOW FC			HIGH GAIN	
20	EQUALIZER	EFF		0dB	500Hz			0dB	
		D:E		DRIVE	LEVEL			EQ LOW	
21	OVER DRIVE	EFF		80	15			0dB	
		D:E		DISTORTION	LEVEL			EQ LOW	
22	DISTORTION	EFF		80	20			0dB	
		D:E		BLEND	EMPHATIC			EQ LOW	
23	EXCITER	EFF		+99	5			0dB	
		D:E		MOD DEPTH				EQ LOW	
24	SYMPHONIC ENS *	50:50		80				0dB	
		D:E		MOD DEPTH	SPPED			SPEED RATIO	
25	ROTARY SP *	EFF		62	FAST			+5	
		D:E	D:E	DELAY TIME	FEEDBACK			HIGH DAMP	
26	DELAY/HALL	70:30	60:40	250mS	+50%			10%	
27	DELAY/ROOM	70:30	60:40	250mS	+50%			10%	
		D:E	D:E	DELAY TIME	FEEDBACK			HIGH DAMP	
28	DELAY/E. REF	70:30	60:40	250mS	+50%			10%	
		D:E	D:E	DELAY TIME	FEEDBACK			HIGH DAMP	
29	DELAY/DELAY	70:30	70:30	250mS	+50%			10%	
		D:E	D:E	DELAY TIME	FEEDBACK			HIGH DAMP	
30	DELAY/CHORUS *	70:30	60:40	250mS	+50%			10%	
		D:E	D:E	DELAY TIME	FEEDBACK			HIGH DAMP	
31	DELAY/FLANGER *	70:30	40:60	250mS	+50%			10%	
		D:E	D:E	DELAY TIME	FEEDBACK			HIGH DAMP	
32	DELAY/PHASER *	70:30	25:75	250mS	+50%			10%	
		D:E	D:E	DELAY TIME	FEEDBACK			HIGH DAMP	
33	DELAY/TREMOLO *	70:30	EFF	250mS	+50%			10%	

When using an effect marked with an asterick (\*) for one of the effects, neither #24 SYMPHONIC ENS nor #25 ROTARY SPEAKER can be selected for the other one

▷		◁	IC/3C	▷	◁	1D/3D	◁	NO	NOTES
E/R LEVEL			EQ LOW	EQ HIGH					
46			-5dB	0dB				01	
46			-3dB	0dB				02	
46			0dB	-2dB				03	
76			+1dB	0dB				04	
76			+2dB	+4dB				05	
60			+3dB	0dB				06	
EQ HIGH									
	0dB							07	
	0dB							08	
	0dB							09	
HIGH DAMP			EQ LOW	EQ HIGH					
10%			0dB	0dB				10	
10%			0dB	0dB				11	
			EQ LOW	EQ HIGH					
			0dB	0dB				12	*
			0dB	0dB				13	*
FEEDBACK			EQ LOW	EQ HIGH					
-75%			0dB	0dB				14	*
+80%			0dB	0dB				15	*
SPEED		WAVEFORM							
0.69Hz	SIN							16	*
0.57Hz	TRI							17	*
			EQ LOW	EQ HIGH					
			0dB	0dB				18	*
			0dB	0dB				19	*
HIGH FC									
	2KHz							20	
EQ HIGH									
	0dB							21	
								22	
EQ HIGH									
	0dB							23	
EQ HIGH									
	0dB							24	*
								25	*
			REVERB TIME	HIGH DAMP		PRE DELAY			
			3.5S	40%		55mS		26	
			1.5S	30%		30mS		27	
			E/R TIME			PRE DELAY			
			200mS			30mS		28	
			DELAY TIME	FEEDBACK		HIGH DAMP			
			260mS	+50%		10%		29	
			MOD DEPTH	SPEED		WAVEFORM			
			60	0.30Hz		TRI		30	*
			MOD DEPTH	SPEED		FEEDBACK			
			70	0.18Hz		-75%		31	*
			MOD DEPTH	SPEED		FEEDBACK			
			60	0.69Hz		-75%		32	*
			MOD DEPTH	SPEED		SHAPE			
			80	1.59Hz		0		33	*

## 5. DRUMS MODE

To enter this mode

①		②	

press the keys in this order ① ②

Key functions

PLAY	PAGE +	▷	△/YES
EDIT	PAGE -	◀	▽/NO

= Keys whose indicators light when in this mode

In this mode you will make settings for drum kits 1 – 4. To make settings for drum kits C1 – C4 (PROG card), you must first use GLOBAL mode [5A] to load the data from card into internal memory. The sound you will hear in this mode is determined by the settings of the program last selected in Program Edit mode. Before you enter this mode, use Program Edit mode to select the program which uses the Drum Kit you want to edit. If you enter this mode when an ordinary program is selected, the drum sounds may be somewhat unnatural.

- Settings made in this mode will be remembered even when the power is turned off. There is no need to write them into memory.

### Functions in DRUMS mode

- When you first enter DRUMS mode, [0A] DRUM KIT 1 will be selected if the Page Memory function is Off. If the Page Memory function is On, you will jump to the parameter that was selected when you last exited this mode. Use the PAGE + and PAGE - keys to select the drum kit you wish to edit.
- If the Effect Interlock function is Off, the effect will not be heard in this mode. If On, the effect will be heard. If pan has been set to C, C+D, or D, and effect interlock is On, there will be no sound from 1/L, 2/R, or the PHONES OUT unless the effect placement setting for output 3/4 has been turned On.

Page	DRUM KIT	Editing parameter	Page reference
0A – 0C	DRUM KIT1	Index, instrument, key, tune, level, decay, and pan for drum kit 1	70
1A – 1C	DRUM KIT2	Index, instrument, key, tune, level, decay, and pan for drum kit 2	71
2A – 2C	DRUM KIT3	Index, instrument, key, tune, level, decay, and pan for drum kit 3	71
3A – 3C	DRUM KIT4	Index, instrument, key, tune, level, decay, and pan for drum kit 4	71

# DRUMS

## 0A — 0C DRUM KIT 1

0A DRUM1 #00 08:Tom	0B KEY/TUNE/L C0 T+000 L+00	0C DECAY/PAN Decay+00 Pan= A
------------------------	--------------------------------	---------------------------------

0A	#	Index	0 - 29	Drum index to edit
		Inst	---, 01-45	Select drum sound
0B		Key	C0 - G8	Key assigned to drum sound
	T	Tune	-120 - +120	Pitch adjustment within $\pm 1$ octave
	L	Level	-99 - +99	Level adjustment for each sound
0C	Decay	Decay	-99 - +99	Decay time adjustment for each sound
	Pan	Pan	A, 9:1 - 1:9, B, C, C + D, D	Output selection

\* This is where you edit the drum kit used as a sound source by a drum-type Program. Up to 30 types of drum index can be assigned to each of 4 drum kits (1-4). (An index is a reference number for each drum or percussion sound in a drum kit.)

▼ Index: This is where you select the drum index to edit.

- An index for which no drum sound is assigned will be indicated by the display "No Assign". (When assigning a new sound, select an index which displays "No Assign".)

▼ Inst is where you select the drum sound used by that index. (The back cover has a list of the drum sounds.)

- If an optional PCM card containing drum sounds has been inserted, card sounds can also be selected using the  $\Delta$ /YES and  $\nabla$ /NO keys. (When playing programs which use PCM card drum sounds, be sure that the appropriate card is inserted.)
- Select "No Assign" for each index which you don't need to assign, and set key ([0B]) to an unused key.

▼ Key determines the key (C0-G8) assigned to that index. (The note name for an octave setting of 8' will be displayed.)

- You will not be able to select keys which have already been assigned to another index.
- Keys which have not been assigned to an index are automatically assigned to the index of the following key. (However the pitch will change according to the scale.)
- By using more than one index, you can assign a single sound to be played by more than one key at the same pitch.

Example:

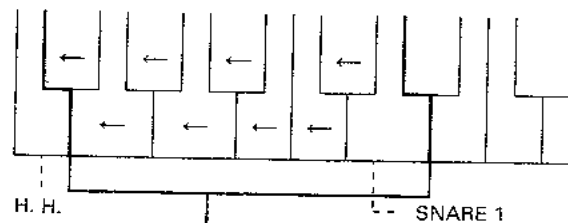

These notes will play SNARE 1 (at different pitches)

- ▼ Tune, Level, and Decay are parameters which determine the pitch, volume, and VDA decay time for each drum index.
  - When the corresponding program parameter is modified, the volume etc. of the entire drum kit will be affected.
  - Other program parameters will also affect the entire drum kit.
- ▼ Tune adjusts the pitch of an assigned key over a range of -120 - +120 (in steps of 10 cents,  $\pm 1$  octave).

- ▼ Level is an adjustment relative to the oscillator level setting in PROGRAM mode, over a range of -99 – +99.
- ▼ Decay is an adjustment relative to the VDA EG decay setting in PROGRAM mode, over a range of -99 – +99.

- ▼ Pan specifies the output; A, A:B (9:1 – 1:9), B, C, C+D, D.
- \* When effect inter lock is Off, you will not be able to monitor C, C+D, or D through headphones.

### **[A – 3C DRUM KIT 2-4**

Details are the same as for [0A] – [0C] DRUM KIT 1.

**M3R PRELOAD DRUM KITS (IN ORDER OF KEYS)**

\* ... PAN:C+D see P.70

**Drum Kit 1**

Key Index: Inst

C2 00 : 01 Kick 1  
 D2 01 : 02 Kick 2  
 E2 02 : 03 Kick 3 \*  
 F#2 03 : 04 Snare 1 \*  
 G#2 04 : 05 Snare 2  
 A#2 05 : 06 Snare 3  
 B2 06 : 07 Side Stick  
 C3 07 : 08 Tom  
 D3 08 : 08 Tom  
 E3 09 : 08 Tom

Key Index: Inst

F3 10 : 11 Closed HH2 \*  
 G3 11 : 12 Open HH2 \*  
 A3 12 : 12 Open HH2 \*  
 B3 13 : 21 Ride  
 C4 14 : 13 Crash  
 D4 15 : 14 Conga 1  
 E4 16 : 15 Conga 2  
 F4 17 : 15 Conga 2  
 G4 18 : 16 Timbales  
 A4 20 : 17 Cowbell

Key Index: Inst

B4 23 : 18 Claps  
 F#5 21 : 22 Rap  
 G#5 22 : 23 Whip  
 C5 24 : 19 Tambourine  
 D5 25 : 34 Perc. WaveH \*  
 E5 26 : 34 Perc. WaveH \*  
 B5 27 : 35 Lore 1  
 C6 28 : 38 Pole  
 D6 29 : 37 Wind Bells  
 C7 19 : 20 E. Tom

**Drum Kit 2**

Key Index: Inst

C2 00 : 01 Kick 1  
 D2 01 : 03 Kick 3  
 F2 02 : 06 Snare 3  
 E2 03 : 05 Snare 2 \*  
 G2 04 : 20 E. Tom  
 A2 05 : 20 E. Tom  
 B2 06 : 20 E. Tom  
 C3 07 : 09 Closed HH1 \*  
 D3 08 : 10 Open HH1 \*  
 E3 09 : 10 Open HH1 \*

Key Index: Inst

F3 10 : 13 Crash  
 G3 11 : 13 Crash  
 A3 12 : 21 Ride  
 B3 13 : 17 Cowbell  
 D4 14 : 14 Conga 1  
 E4 15 : 15 Conga 2  
 F4 16 : 15 Conga 2  
 C4 17 : 14 Conga 1  
 G4 18 : 19 Tambourine \*  
 A4 19 : 31 Vibe Hit

Key Index: Inst

B4 20 : 31 Vibe Hit  
 C5 21 : 30 Clicker 2  
 D5 22 : 28 Gamelan 2  
 E5 23 : 28 Gamelan 2  
 G5 24 : 43 Spectrum3H  
 B5 25 : 42 Spectrum3L  
 C6 26 : 18 Claps  
 D6 27 : 09 Closed HH1  
 E6 28 : 10 Open HH1  
 G8 29 : 35 Lore 1

**Drum Kit 3**

Key Index: Inst

C2 00 : 03 Kick 3  
 D2 01 : 03 Kick 3 \*  
 E2 02 : 01 Kick 1  
 F2 03 : 14 Conga 1  
 G2 04 : 04 Snare 1 \*  
 A2 05 : 04 Snare 1 \*  
 B2 06 : 05 Snare 2 \*  
 C3 07 : 09 Closed HH1 \*  
 D3 08 : 10 Open HH1 \*  
 E3 09 : 10 Open HH1 \*

Key Index: Inst

F3 10 : 13 Crash  
 G3 11 : 21 Ride  
 A#3 12 : 21 Ride  
 B3 13 : 21 Ride \*  
 C4 14 : 14 Conga 1  
 D4 15 : 15 Conga 2  
 E4 16 : 19 Tambourine \*  
 F4 17 : 23 Whip \*  
 G4 18 : 37 Wind Bells  
 A#4 19 : 20 E. Tom

Key Index: Inst

B4 20 : 20 E. Tom  
 C5 21 : 42 Spectrum3L  
 E5 22 : 43 Spectrum3H \*  
 F5 23 : 33 Perc. WaveL  
 G5 24 : 33 Perc. WaveL  
 C6 25 : 45 Spectrum4H  
 F#6 26 : 43 Spectrum3H  
 G6 27 : 44 Spectrum4L  
 A#6 28 : 07 Side Stick \*  
 G8 29 : 10 Open HH1

**Drum Kit 4**

Key Index: Inst

D0 12 : -- No Assign  
 D#0 13 : -- No Assign  
 E0 14 : -- No Assign  
 F0 15 : -- No Assign  
 F#0 16 : -- No Assign  
 G0 17 : -- No Assign  
 G#0 18 : -- No Assign  
 A0 19 : -- No Assign  
 A#0 20 : -- No Assign  
 B0 21 : -- No Assign

Key Index: Inst

C1 22 : -- No Assign  
 C#1 23 : -- No Assign  
 D1 24 : -- No Assign  
 D#1 25 : -- No Assign  
 E1 26 : -- No Assign  
 F1 27 : -- No Assign  
 F#1 28 : -- No Assign  
 G1 29 : -- No Assign  
 D2 02 : 17 Cowbell  
 G#2 03 : 42 Spectrum3L

Key Index: Inst

F3 00 : 14 Conga 1  
 D4 01 : 15 Conga 2  
 C5 04 : 17 Cowbell  
 F#5 05 : 16 Timbales  
 C6 06 : 45 Spectrum4H  
 F6 07 : 34 Perc. WaveH  
 A#6 08 : 25 Bell Ring  
 D#7 09 : 30 Clicker 2  
 G7 11 : 25 Bell Ring  
 C8 10 : 38 Pole



## 6. GLOBAL MODE

To enter this mode

①	②		

①②=press this key in this order.

Key functions

PLAY	PAGE +	▷	△ / YES
EDIT	PAGE -	◁	▽ / NO

= Keys whose indicators light when in this mode

In global mode you can make settings for parameters which affect the entire M3R (overall tunings and MIDI settings).

- With the exception of some MIDI parameters, the settings made in this mode are remembered even when the power is turned off. There is no need to write them into memory.

### Functions in GLOBAL mode

- If the Page Memory function is On when you enter GLOBAL mode, you will jump to the parameter that was selected when you last exited GLOBAL mode. If the Page Memory function is OFF, [0A] MASTER TUNE will be selected. Use the PAGE + and PAGE - keys to select the page that contains the parameters you wish to edit.

Page		Editing parameter	Page reference
0A	MASTER TUNE/ KEY TRANSPOSE	Overall pitch adjustment Overall transpose	74
1A - 1B 1B - 1E	SCALE TYPE (USER SCALE)	Select type of scale (equal tempered, just, etc.) (User scale settings)	75
2A - 2C	MIDI GLOBAL/ FILTERING	Settings for MIDI global channel, MIDI overflow Transmission/reception switch for various MIDI messages	76
3A - 3B	MEMORY PROTECT	Protection ON/OFF for writing into parameter memory	76
3C	EFFECT INTERLOCK	Effect Interlock function setting	
3D	PAGE MEMORY	Page Memory function setting	
4A	MIDI DATA DUMP	Transmit various parameters as a MIDI system exclusive message	77
5A - 5D	LOAD FROM CARD/ SAVE TO CARD/ FORMAT CARD PRESET DATA LOAD	Load preset data	78

## GLOBAL

### 0A MASTER TUNE / KEY TRANSPOSE

0A TUNE/TRANS  
Tune+00 Trans+00

0A	Tune	Master Tune	-50 - +50	Overall tuning of the M3R (steps of 1 cent)
	Trans	Key Transpose	-12 - +12	Overall transposition of the M3R (chromatic steps)

▼ Master Tune adjusts the tuning of the entire M3R over a range of  $\pm 50$  cents. Use this when tuning the M3R to other instruments.

▼ Key Transpose adjusts the pitch of the entire M3R over a range of  $\pm 1$  octave, in chromatic steps. This can be used to play songs of a difficult key signature in an easier key.

- When the GLOBAL mode setting 2A overflow is "ON", note on/off messages sent from MIDI OUT will be transposed to match this setting.

## 1A — 1E SCALE TYPE

1A SCALE TYPE Equal Temp	1B Pure Major Key=C	1B User Scale C+00 C#+00 D+00	1C User Scale D#+00 E+00 F+00	1D User Scale F#+00 G+00 G#+00	1E User Scale A+00 A#+00 B+00
-----------------------------	------------------------	----------------------------------	----------------------------------	-----------------------------------	----------------------------------

1A		Equal Temp		Equal temperament
		Equal Temp 2		Equal temperament with a randomized pitch for each note
		Pure Major		Just intonation for the major scale
		Pure Minor		Just intonation for the minor scale
		User Scale		A scale of pitches set by the user
1B	Key	Key	C-B	Tonic for the just intonation scale

1B	C	C	-50 - +50	User scale, specified as pitch deviation (in cents) from equal temperament for each note
	C#	C#	-50 - +50	
1C	D	D	-50 - +50	
	D#	D#	-50 - +50	
	E	E	-50 - +50	
1D	F	F	-50 - +50	
	F#	F#	-50 - +50	
	G	G	-50 - +50	
1E	G#	G#	-50 - +50	
	A	A	-50 - +50	
	A#	A#	-50 - +50	
	B	B	-50 - +50	

\* This is where you select a scale (temperament). The specified scale type will apply to all voices.

▼ Equal Temp.: This temperament is widely used in keyboard instruments, since chords will sound the same at any transposition.

▼ Equal Temp.2: Each time you play a note, the pitch will randomly deviate from equal temperament. This is useful when simulating instruments that have a somewhat unstable pitch.

▼ Pure Major: Just intonation temperaments are designed so that chords played in the key of the tonic will sound good. Select a tonic of C-B in [1B].

▼ Pure Minor: Select a tonic of C-B in [1B].

▼ User scale: For each note of the equal tempered scale, you can specify an offset of  $\pm 50$  cents to create your own scale. This can be used to play unique temperaments other than the preset temperaments. Use [1B] - [1E] to specify the scale degree.

- Even if [0A] key transpose is used, the "Pure Major, Pure Minor, User Scale" settings will define the pitch which is actually sounded.

Example: If the User Scale defines C as +10 and Transpose is set to +1, when a MIDI note of C arrives, C# will be sounded, and when a MIDI note of B arrives, C+10 cents will be sounded.

## 2A — 2C MIDI GLOBAL / FILTER

2A MIDI GLOBAL CH= 1 OVFL:OFF	2B MIDI FILTER PRG:ENA AFT:ENA	2C MIDI FILTER CTRL:ENA EX:DIS
----------------------------------	-----------------------------------	-----------------------------------

2A	CH	Channel	1 – 16	Channel on which musical data will be received
	OVFL	Overflow	OFF/ON	MIDI overflow switch
2B	PRG	Combination/Program Change Filter	DIS/ENA	When "DIS" is selected, the corresponding type of MIDI data will neither be transmitted nor received.
	AFT	After Touch Filter	DIS/ENA	
2C	CTRL	Control Change Filter	DIS/ENA	
	EX	Exclusive Filter	DIS/ENA	

▼ Channel determines the MIDI transmission/reception channel.

- In COMBINATION mode when type is set to Multi, MIDI data arriving on channels other than the channel specified here may be received.

▼ When Overflow is set "ON", incoming MIDI data which exceeds the maximum simultaneous note capacity will be re-transmitted from MIDI OUT. If you have connected another M3R to MIDI OUT, this allows you to increase the simultaneous note capacity.

- Be sure that both M3Rs are set to the same program/combination.
- If MIDI OUT is connected to a device other than another M3R, set this "OFF".
- When the power is turned on, this setting will be "OFF".
- When this setting is On, data received at MIDI IN (program change, aftertouch, control change, etc.) will always be transmitted from MIDI OUT.

\* [2B] – [2C] allow you to disable (filter) reception and transmission of specified types of MIDI data.

▼ When Combination / Program Change is set to "DIS", combination (program) changes will neither be transmitted nor received.

▼ When Control Change is set to "DIS", control change messages (damper, modulation 1 and 2, pitch bender, volume, rotary speaker speed) will neither be transmitted nor received.

▼ When After Touch is set to "DIS", aftertouch data will not be received.

▼ When Exclusive is set to "DIS", system exclusive messages for parameter changes or data will neither be transmitted nor received.

☆ System exclusive parameter changes are used by personal computer voice editing programs.

When two M3Rs are connected and Exclusive is set to "ENA", you can simultaneously edit the voice data of both units.

- When the M3R is connected to other types of MIDI devices, set this to "DIS".

## 3A — 3D MEMORY PROTECT /EFFECT INTERLOCK / PAGE MEMORY

3A PROTECT PROGRAM:OFF	3B. PROTECT COMBINATION:OFF	3C EFFECT Interlock:OFF	3D PAGE MEMORY OFF
---------------------------	--------------------------------	----------------------------	-----------------------

3A	PROGRAM	Program	OFF/INT/CARD/ ALL	Memory protect (write protection) for internal and card programs
3B	COMBINATION	Combination	OFF/INT/CARD/ ALL	Memory protect (write protection) for internal and card combinations
3C	INTERLOCK	EFFECT Interlock	OFF/ON	Enables/disables Effect Interlock (see below)
3D		Page Memory	OFF/ON	Enables/disables Page Memory (see below)

- \* These settings prohibit writing data into internal memory or RAM card.
- ▼ “INT” prohibits writing data into internal memory. “CARD” prohibits writing data into a RAM card. “ALL” prohibits both.
  - The protect switch on the upper part of a RAM card also lets you prohibit writing.
- ▼ When Effect Interlock is On, the last selected effect will be applied in all modes. When Off, the effect will not be heard in PROG EDIT and DRUMS modes. When this is Off, a drum sound whose pan has been set to C, C+D, or D will not be heard through headphones.
- ▼ When Page Memory is On, the Page Memory function

will operate. When entering a mode, this function allows you to automatically jump to the page (parameter) that was last selected when you exited that mode. However in COMBI EDIT and PROG EDIT modes, the [0A] SELECT page for COMBI or PROG will appear first, and pressing the PAGE+ button will jump to the previously selected parameter. The page memory will be cleared if you use [0A] to change the COMBI or PROG number. This also applies to Combination Play mode parameters when the RE1 is connected.

## 4A MIDI DATA DUMP

4A MIDI DUMP
PROGRAM      OK?

4A		PROGRAM	Transmit all program parameters
		COMBINATION	Transmit all combination parameters
		GLOBAL	Transmit global parameters ([0A] — [1E])
		DRUM KIT	Transmit all drum data
		ALL DATA	Transmit all program/combination/global/drum parameters
	OK?	[OK?]	Execute dump

- ▼ Internal data parameters can be transmitted (dumped) via MIDI.

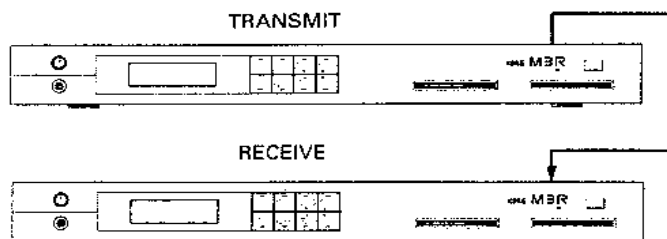

- When this page is selected, MIDI data dumps can be transmitted and received regardless of the MIDI exclusive filtering setting.
- In order for data to be received, the MIDI global channel must match that of the transmitting device, and memory protect must be turned “OFF”. No other special measures are necessary when receiving data.
- \* PROGRAM transmits all program parameters. Transmission time is 2.7 seconds.
- \* COMBINATION transmits all combination data. Transmission time is 4.5 seconds.
- \* GLOBAL DATA transmits global parameters ([0A] — [1E], [3C]). Transmission time is nearly instantaneous.

- \* DRUMKIT transmits all drum data. Transmission time is nearly instantaneous.

- \* ALL DATA transmits program parameters, combination parameters, drum data, and global parameters at once. Transmission time is 7.7 seconds.
  - Move the cursor to “OK” and press the  $\Delta$  /YES key, and the data dump will be executed.

- ☆ MIDI devices such as the SQD-8 which can save exclusive data allow you to store voice data using an external device.

Data type	Length of exclusive message
Program (100)	approximately 8.6 Kbytes
Combination (100)	approximately 14.4 Kbytes
Global data	31 bytes
Drum data	approximately 1.0 Kbyte
All data	approximately 24.0 Kbytes

- ☆ For details of the exclusive message data format, see the end of this manual. You may also refer to the separate volume MIDI MINI TEXT.

## 5A LOAD FROM CARD / SAVE TO CARD / FORMAT CARD / PRESET DATA LOAD

5A LOAD CARD Load OK?	5B SAVE Save to CARD OK?	5C FORMAT Format CARD OK?	5D PRESET DATA LOAD OK?
--------------------------	-----------------------------	------------------------------	----------------------------

5A	LOAD FROM CARD	Load all program / combination / drum data / global data from card
	[OK]	Execute loading
5B	SAVE TO CARD	Save all program / combination / drum data / global data to card
	[OK]	Execute saving
5C	FORMAT CARD	Format a RAM card
	[OK]	Execute formatting
5D	PRESET DATA LOAD	Load the preset data (program/combination/drum data)
	[OK?]	Execute formatting (initialization)

- ▼ **LOAD FROM CARD** loads (writes) data saved in a ROM card or RAM card into internal memory.

The previous data in internal memory will be lost when you load, so be sure to save the internal memory data to another card first.

- Loading will not be possible if memory protect is set. (Use [3A] [3B] to defeat memory protect.)
- Move the cursor to "OK" and press  $\Delta$  /YES to execute loading.
- ☆ Programs C00 – C99 specified by combination parameters will be replaced with I00 – I99 when they are loaded from card into internal memory.
- ☆ The demo performance data in a card cannot be loaded into memory.

- ▼ **SAVE TO CARD** saves (writes) data from internal memory to a RAM card.

- Before saving data into a new card, you must first format (initialize) it using the steps explained in the following section [5C].
- Saving will not be possible if the card memory protect is set. (Use [3A] [3B] to defeat memory protect.)

- The protect slider located on the upper part of the card must be set to "OFF".

When you save data into a card, the previous data in the card will be lost. To avoid accidentally losing important card data, leave the card protect switch on.

- Move the cursor to "OK?" and press  $\Delta$  /YES to execute saving.
- ☆ Programs I00 – I99 specified by combination parameters will be replaced with C00 – C99 when they are saved from internal memory to a card.

- ▼ **FORMATCARD** determines the format of a RAM card, and initializes it to accept data.

- ☆ When purchasing a card, specify the Korg Memory Card RAM (256K Bits) "MCR-03".
- Newly purchased RAM cards must be formatted before they can be used to save or write data.

Formatting a card which already contains data will erase all the data in the card. To avoid accidentally losing important card data, leave the card protect switch on.

- Move the cursor to "OK?" and press  $\Delta$  /YES to execute formatting.

- ▼ **PRESET DATA LOAD** will load the preset data (factory settings) from internal ROM into the internal memory.

- Move the cursor to "OK?", and if you are sure you want to load the preset data, press  $\Delta$  /YES. The preset data will overwrite the data previously in internal memory. (Be sure to save your important data to a card before using this function.)

# CONNECTION TO THE RE1

Connecting the separately sold RE1 Remote Editor will speed up editing and other operations.

## CONNECTIONS

First, turn off the power of the M3R.

- (1) Using the cable included with the RE1, connect the M3R rear panel REMOTE jack and the RE1 REMOTE jack.
- (2) Turn the M3R power on. Power will be applied to the RE1 at the same time and the RE1 will be able to control the M3R.

Note:

While the RE1 is connected, the R3R will display "Remote Control from RE1" and none of its switches will function. The LEDs of each key will function only as MIDI indicators, and will not indicate the mode. (When Exclusive Data is received, the "PLAY" LED will illuminate.)

## RE1 OPERATION

### ◆ Function key operations

Affix the RE1 stickers included with the M3R.

The function key corresponding to each mode will light (except for Demo Play). Please affix the accessory reel to the M3R.

M3R	RE1
COMBINATION PLAY MODE	F1
COMBINATION EDIT MODE	F2
EFFECT MODE	F3
GLOBAL MODE	F4
DRUMS MODE	F5
DEMO PLAY	F6
	F1 + F2

### ◆ To select combinations

- (1) Use function key 1 (F1, 2) to select COMBINATION PLAY mode.  
(in COMBINATION PLAY mode)
- (2) Use the 0 - 9 and the UP/DOWN keys to select the COMBINATION NO. Press any key to stop playback.
  - If a Program card is inserted into the M3R, you will also be able to use the CARD key to select combinations from a card (C00—C99).

### ◆ To hear the demo songs

- (1) Simultaneously press function keys 1 and 2 (F1, 2) and you will enter demo play mode.
- (2) When you press a key 0—4, the corresponding demo song will begin playing. If you press key 5, all the demo songs will play back successively. Press any key to stop playback.
- (3) When you press function key 1 or 2 (F1, 2) once again, you will exit demo play mode.

# THE DISPLAY

The cursor printed here indicates the parameter which will flash on the display.

## COMBINATION PLAY mode

- In this mode you can select and play Combinations. You can also edit the Program numbers used by each Combination, and adjust the output levels in realtime. (However those changes will not be written, so if you want to keep your edits, enter Combination Edit mode and write them into memory.)
- Even while editing the program number or the output level, you can press the F1 key to return to the same condition as when you first selected that combination
- Displays will differ depending on the combination type

### SINGLE

COMBI 101	GrandPiano	100: Piano 1B	Level: 99	[A]	[B]	[C]	[D]	[E]	[F]	[G]	[H]
-----------	------------	---------------	-----------	-----	-----	-----	-----	-----	-----	-----	-----

Key and slider A will select programs. (Keys and sliders B and C will have the same effect.)  
Key and slider D will adjust the output level. (Keys and sliders E—H will have the same effect.)

### LAYER

COMBI 103	String Pad	137: AnaLog 1	199	138: Strings	142	[A]	[B]	[C]	[D]	[E]	[F]	[G]	[H]
-----------	------------	---------------	-----	--------------	-----	-----	-----	-----	-----	-----	-----	-----	-----

Layer 1 or layer 2 program will blink  
Key and slider A will select the program of layer 1. (B and C will have the same effect.)  
Key and slider D will adjust the level of layer 1.  
Key and slider E will select the program of layer 2. (F and G will have the same effect.)  
Key and slider H will adjust the level of layer 2

### SPLIT

COMBI C01	Combi 002	121: DigitalBell 2	SP=C4	125: Kalimba	[A]	[B]	[C]	[D]	[E]	[F]	[G]	[H]
-----------	-----------	--------------------	-------	--------------	-----	-----	-----	-----	-----	-----	-----	-----

Upper or lower program will blink  
Key and slider A will select the program of the lower layer. (B and C will have the same effect.)  
Key and slider D will adjust the split point. (E will have the same effect.)  
Key and slider F will select the program of the upper layer. (G and H will have the same effect.)

### VELOCITY SWITCH

COMBI C03	Combi 003	134: Voices	VP=083	145: BWS Voice	[A]	[B]	[C]	[D]	[E]	[F]	[G]	[H]
-----------	-----------	-------------	--------	----------------	-----	-----	-----	-----	-----	-----	-----	-----

Soft or loud program will blink  
Key and slider A will select the program of the soft layer. (B and C will have the same effect.)  
Key and slider D will adjust the velocity switch point. (E will have the same effect.)  
Key and slider F will select the program of the loud layer. (G and H will have the same effect.)

◆ MULTI

COMBI 100 Krypton  
 120 174 135 127 OFF OFF OFF OFF  
 [A] [B] [C] [D] [E] [F] [G] [H]

PROGRAM NAME  
 Keys and sliders A—H will select the programs for timbres 1—8.

COMBI 100 Krypton  
 15 30 71 50 99 99 99 99  
 [A] [B] [C] [D] [E] [F] [G] [H]

PROGRAM NAME FOR WHICH LEVEL IS BEING SET

When you press the PAGE+ keys, the output level of each timbre will be displayed. Use the keys and sliders to adjust the output levels.

Modes other than COMBINATION PLAY

- (1) Use the function keys to select the mode to edit.
- (2) Use the 0—9 and PAGE+ keys to select the page to edit.
- (3) Use keys and sliders A—H and the UP/DOWN keys to select and edit parameters.
  - Keys 0—9 will directly select pages. Pages such as "X—X" can be selected as follows:  
 Example: To select "5—1", press the 5 key and then the PAGE+ key once.

■ COMBINATION EDIT mode (F2)

PAGE

0 COMBINATION SELECT/RENAME/WRITE  
 0 A ~ 0 C

COMBI 100 Krypton Select Combi  
 SELECT:100 [( ) ] [WRITE]: 100  
 [A] [B] [C] [D] [E] [F] [G] [H]

• Use A (or B) in this section. A—H in parentheses following a key indicates that these keys will have the same operation.) to select the combination number to edit.

• Use the C, D keys to move the cursor to the character to modify, and use sliders C—B or the UP/DOWN keys to modify the character.

• Press the F key to get the "Are You Sure?" display. If you want to write the new setting into memory, press the G key (YES). Otherwise, press the H key (NO). After executing writing, press a key A—H to return to the previous display.

1 COMBINATION TYPE SELECT

COMBI 100 TYPE SELECT  
 MULTIE [SELECT]  
 [A] [B] [C] [D] [E] [F] [G] [H]

When you press the UP/DOWN keys or move a slider, A—H, the display will show [SELECT] above G and H. Use A—F to select the combination type, and press the G key (SELECT) to finalize your selection.

2 PROGRAM/LEVEL/PANPOT

SINGLE  
 PROGRAM/LEVEL/PANPOT [Combi Name]  
 COMBI 101 GrandPiano  
 100: Piano 16 Level: 99 Pan: 5.5  
 [A] [B] [C] [D] [E] [F] [G] [H]

Pages 2 and later will differ according to the combination type.

2	<p>LAYER</p> <p>LAYER 142 PROGRAM/LEVEL [Combi Type]                  COMBI 103 LAYER [Layer 1 Program]                  137 Analog 1 199 138 Strings 142                  [A] [B] [C] [D] [E] [F] [G] [H]</p> <p>LAYER 142 PANPOT/DAMP/ FILTER/ INTERVAL/DETUNE                  COMBI 108 LAYER [Layer 1 PANPOT]                  5.5 ENA C-D ENA 1-12 D-00                  [A] [B] [C] [D] [E] [F] [G] [H]</p>	2 A, 2 B 3 A, 3 B
3	<p>SPLIT</p> <p>SPLIT POINT, LOWER &amp; UPPER PROGRAM                  COMBI 100 SPLIT [Lower Program]                  100: Prog 001 SP: C4 [01: Prog 002]                  [A] [B] [C] [D] [E] [F] [G] [H]</p> <p>LOWER &amp; UPPER LEVEL/PAN/DAMP/ FILTER                  COMBI 100 SPLIT [Lower Level]                  199 5.5 ENA 199 5.5 ENA                  [A] [B] [C] [D] [E] [F] [G] [H]</p>	2 A, 3 A 4 A
2	<p>VELOCITY SWITCH</p> <p>VELOCITY SW POINT, SOFT &amp; LOUD PROGRAM                  COMBI 100 VEL SW [Soft Program]                  102: Prog 003 VP: 063 [03: Prog 004]                  [A] [B] [C] [D] [E] [F] [G] [H]</p> <p>SOFT &amp; LOUD LEVEL/PAN/DAMP/ FILTER                  COMBI 100 VEL SW [Soft Level]                  199 5.5 ENA 199 5.5 ENA                  [A] [B] [C] [D] [E] [F] [G] [H]</p>	2 A, 3 A 4 A
3	<p>MULTI (A—H correspond to timbres 1—8)</p> <p>PROGRAM SELECT                  COMBI 100 PROGRAM SELECT TI=Clicker                  129 174 135 127 OFF OFF OFF OFF                  [A] [B] [C] [D] [E] [F] [G] [H]</p> <p>OUTPUT LEVEL                  COMBI 100 OUTPUT LEVEL TI=Clicker                  15 30 71 50 99 99 99 99                  [A] [B] [C] [D] [E] [F] [G] [H]</p> <p>MIDI CHANNEL                  COMBI 100 MIDI CH TI=Clicker                  16 16 16 16 16 16 16 16                  [A] [B] [C] [D] [E] [F] [G] [H]</p>	2 A, 2 B 3 A, 3 B
4	<p>COMBI 100 Krypton</p> <p>PROGRAM NAME                  Keys and sliders A—H will select the programs for timbres 1—8.</p>	4 A, 4 B



5	5 A, 5 B	9	9 A, 9 B
KEY WINDOW TOP		PANPOT	
COMBI 100 KEY WINDOW TOP TI=Clicker G9 G8 G9 G9 G9 G9 G9 G8		COMBI 100 PANPOT TI=Clicker 5:5 C+D 5:5 C1D 5:5 5:5 5:5 5:5	
KEY WINDOW BOTTOM			
COMBI 100 X WINDOW BOTTOM TI=Clicker C1 C1 C1 C1 C1 C1 C1 C1			
6	6 A, 6 B	0	0 A ~ 0 C
VELOCITY WINDOW TOP		PROGRAM SELECT/RENAME/WRITE	
COMBI 100 VEL WINDOW TOP TI=Clicker 127 127 127 127 127 127 127		PROG 100 Piano 16 Select Program SELECT:100 [(F) F] [RE] TE] - 100 Use A (B) to select the program number to edit. Use the C, D keys to move the cursor to the character you wish to modify, and use sliders C→E or the UP/DOWN keys to modify the character. Press the F key to get the "Are You Sure?" display. If you want to write the new setting into memory, press the G key (YES). Otherwise press the H key (NO). After executing, writing, press a key A→H to return to the previous display.	
VELOCITY WINDOW BOTTOM			
COMBI 100 Y WINDOW BOTTOM TI=Clicker 001 001 001 001 001 001 001			
7	7 A, 7 B	0 - 1	1 C, 1 D
KEY TRANSPOSE		OSC TYPE/ASSIGN/HOLD	
COMBI 100 TRANSPOSE TI=Clicker +12 +00 -12 +00 +00 +00 +00 +00		PROG 100 OSC BASIC OSC Type K-SOUND POLY Hold:OFF MULTISOUND/OSC LEVEL/OCTAVE/DELAY START PROG 100 M-SOUND Multisound 00:Piano 180 16 Delay=00	
DETUNE			
COMBI 100 DETUNE TI=Clicker +00 +00 +00 +00 +00 +00 +00			
8	8 A	2	2 A ~ 2 C
MIDI PROGRAM CHANGE FILTER		PITCH EG	
COMBI 100 MIDI PROG CHG TI=Clicker ENA ENA ENA ENA ENA ENA		PROG 100 PITCH EG Start Level S100 AT00 A+00 DT00 RT00 R+00 L+00 T+00	
DAMPER FILTER			
COMBI 100 DAMPER TI=Clicker ENA ENA ENA ENA ENA ENA		VDF CUTOFF/EG INTENSITY PROG 100 VDF Cutoff=38 EG Intensity=49	
8 - 2	8 C	4	3 B ~ 3 D
AFTER TOUCH FILTER		VDF EG	
COMBI 100 AFTER TOUCH TI=Clicker ENA ENA ENA ENA ENA ENA		PROG 100 VDF EG Attack Time AT00 A+94 DT94 B101 ST80 S+00 RT98 R+99	
8 - 3	8 D	5	4 A, 4 B
CONTROL CHANGE FILTER		VDF VELOCITY SENSE	
COMBI 100 CONTROL CHANGE TI=Clicker ENA ENA ENA ENA ENA ENA		PROG 100 VDF YDL SENS EG Intensity EG Int=184 EG Line=03 AT0 DT1 ST0 RT0	

5 -- 1	VDF KEYBOARD TRACK	4 C, 4 D
	PROG 100 VDF KBD TRK Center Key F#3 F-58 Egtime=00 ATO DTO STO RTO <input type="checkbox"/> <input type="checkbox"/> <input type="checkbox"/> <input type="checkbox"/> <input type="checkbox"/> <input type="checkbox"/> <input type="checkbox"/> <input type="checkbox"/> <input type="checkbox"/> <input type="checkbox"/> <input type="checkbox"/> <input type="checkbox"/> <input type="checkbox"/> <input type="checkbox"/> <input type="checkbox"/> <input type="checkbox"/>	
6	VDA EG	5 A ~ 5 C
	PROG 100 VDA EG Attack Time A100 AL75 DT22 BP99 ST63 SL00 RT28 <input type="checkbox"/> <input type="checkbox"/> <input type="checkbox"/> <input type="checkbox"/> <input type="checkbox"/> <input type="checkbox"/> <input type="checkbox"/> <input type="checkbox"/> <input type="checkbox"/> <input type="checkbox"/> <input type="checkbox"/> <input type="checkbox"/> <input type="checkbox"/> <input type="checkbox"/> <input type="checkbox"/> <input type="checkbox"/>	
7	VDA VELOCITY SENSE	6 A, 6 B
	PROG 100 VDA VBL SENS Amplitude A176 Egtime=00 ATO DTO STO RTO <input type="checkbox"/> <input type="checkbox"/> <input type="checkbox"/> <input type="checkbox"/> <input type="checkbox"/> <input type="checkbox"/> <input type="checkbox"/> <input type="checkbox"/> <input type="checkbox"/> <input type="checkbox"/> <input type="checkbox"/> <input type="checkbox"/> <input type="checkbox"/> <input type="checkbox"/> <input type="checkbox"/> <input type="checkbox"/>	
7 -- 1	VDA KEYBOARD TRACK	6 C, 6 D
	PROG 100 VDA KBD TRK Center Key F#4 A+00 Egtime=00 ATO DTO STO RTO <input type="checkbox"/> <input type="checkbox"/> <input type="checkbox"/> <input type="checkbox"/> <input type="checkbox"/> <input type="checkbox"/> <input type="checkbox"/> <input type="checkbox"/> <input type="checkbox"/> <input type="checkbox"/> <input type="checkbox"/> <input type="checkbox"/> <input type="checkbox"/> <input type="checkbox"/> <input type="checkbox"/> <input type="checkbox"/>	
8	PITCH MG	7 A, 7 B
	PROG 100 PITCH MG Waveform TRIANGLE F64 D00 I00 K.Sync:OFF <input type="checkbox"/> <input type="checkbox"/> <input type="checkbox"/> <input type="checkbox"/> <input type="checkbox"/> <input type="checkbox"/> <input type="checkbox"/> <input type="checkbox"/> <input type="checkbox"/> <input type="checkbox"/> <input type="checkbox"/> <input type="checkbox"/> <input type="checkbox"/> <input type="checkbox"/> <input type="checkbox"/> <input type="checkbox"/>	
8 -- 1	VDF MG	7 C, 7 D
	PROG 100 VDF MG Waveform TRIANGLE F84 D00 I00 K.Sync:OFF <input type="checkbox"/> <input type="checkbox"/> <input type="checkbox"/> <input type="checkbox"/> <input type="checkbox"/> <input type="checkbox"/> <input type="checkbox"/> <input type="checkbox"/> <input type="checkbox"/> <input type="checkbox"/> <input type="checkbox"/> <input type="checkbox"/> <input type="checkbox"/> <input type="checkbox"/> <input type="checkbox"/> <input type="checkbox"/>	
9	AFTER TOUCH	8 A, 8 C
	PROG 100 AFTER TOUCH Pitch P100 P#00 F#00 F#00 Amp+00 <input type="checkbox"/> <input type="checkbox"/> <input type="checkbox"/> <input type="checkbox"/> <input type="checkbox"/> <input type="checkbox"/> <input type="checkbox"/> <input type="checkbox"/> <input type="checkbox"/> <input type="checkbox"/> <input type="checkbox"/> <input type="checkbox"/> <input type="checkbox"/> <input type="checkbox"/> <input type="checkbox"/> <input type="checkbox"/>	
9 -- 1	CONTROL CHANGE	9 A ~ 9 C
	PROG 100 CONTROL CHANGE Pitch Bend P+02 F+00 P05 M#0 F10 M#0 <input type="checkbox"/> <input type="checkbox"/> <input type="checkbox"/> <input type="checkbox"/> <input type="checkbox"/> <input type="checkbox"/> <input type="checkbox"/> <input type="checkbox"/> <input type="checkbox"/> <input type="checkbox"/> <input type="checkbox"/> <input type="checkbox"/> <input type="checkbox"/> <input type="checkbox"/> <input type="checkbox"/> <input type="checkbox"/>	

<b>EFFECT mode (F4)</b> PAGE		<b>MER</b> 0 A ~ 0 C
0	EFFECT 1 Select EFFECT 1 01: Hall OFF <input type="checkbox"/> <input type="checkbox"/> <input type="checkbox"/> <input type="checkbox"/> <input type="checkbox"/> <input type="checkbox"/> <input type="checkbox"/> <input type="checkbox"/> <input type="checkbox"/> <input type="checkbox"/> <input type="checkbox"/> <input type="checkbox"/> <input type="checkbox"/> <input type="checkbox"/> <input type="checkbox"/> <input type="checkbox"/>	Use A~E to select an effect, and F to H to turn it OFF/ON.
1	EFFECT Parameter This will differ depending on the effect you selected in PAGE 0, EFFECT 1. (See the following item.)	1 A ~ 1 D
2	EFFECT 2 Select EFFECT 2 02: Ensemble Hall ON <input type="checkbox"/> <input type="checkbox"/> <input type="checkbox"/> <input type="checkbox"/> <input type="checkbox"/> <input type="checkbox"/> <input type="checkbox"/> <input type="checkbox"/> <input type="checkbox"/> <input type="checkbox"/> <input type="checkbox"/> <input type="checkbox"/> <input type="checkbox"/> <input type="checkbox"/> <input type="checkbox"/> <input type="checkbox"/>	2 A ~ 2 C
3	EFFECT Parameter This will differ depending on the effect you selected in PAGE 2, EFFECT 2. (See the following item.)	3 A ~ 3 D
4	PLACEMENT/OUT 384 PANPOT EFFECT PLACEMENT Parallel 3= OFF 4= OFF <input type="checkbox"/> <input type="checkbox"/> <input type="checkbox"/> <input type="checkbox"/> <input type="checkbox"/> <input type="checkbox"/> <input type="checkbox"/> <input type="checkbox"/> <input type="checkbox"/> <input type="checkbox"/> <input type="checkbox"/> <input type="checkbox"/> <input type="checkbox"/> <input type="checkbox"/> <input type="checkbox"/> <input type="checkbox"/>	4 A, 4 B
1, 3	EFFECT Parameter Use PAGE 0/2 to select the effect type <b>REVERB</b> 1. HALL EFFECT 1 Hall Reverb Time [s] 3.5 D055 E46 HD40 L-05 H+00 60:40 <input type="checkbox"/> <input type="checkbox"/> <input type="checkbox"/> <input type="checkbox"/> <input type="checkbox"/> <input type="checkbox"/> <input type="checkbox"/> <input type="checkbox"/> <input type="checkbox"/> <input type="checkbox"/> <input type="checkbox"/> <input type="checkbox"/> <input type="checkbox"/> <input type="checkbox"/> <input type="checkbox"/> <input type="checkbox"/>	(common to 1-6) A: Reverb Time B: Pre Delay C: Early Reflection Level D: High Damp E: ----- F: Equalizer Low G: Equalizer High H: Effect Balance
	2. ENSEMBLE HALL EFFECT 1 Ensemble HL Reverb Time [s] 2.8 D030 E46 HD40 L-08 H+00 60:40 <input type="checkbox"/> <input type="checkbox"/> <input type="checkbox"/> <input type="checkbox"/> <input type="checkbox"/> <input type="checkbox"/> <input type="checkbox"/> <input type="checkbox"/> <input type="checkbox"/> <input type="checkbox"/> <input type="checkbox"/> <input type="checkbox"/> <input type="checkbox"/> <input type="checkbox"/> <input type="checkbox"/> <input type="checkbox"/>	
	3. CONCERT HALL EFFECT 1 Concert HL Reverb Time [s] 3.8 D120 E46 HD40 L+00 H-02 60:40 <input type="checkbox"/> <input type="checkbox"/> <input type="checkbox"/> <input type="checkbox"/> <input type="checkbox"/> <input type="checkbox"/> <input type="checkbox"/> <input type="checkbox"/> <input type="checkbox"/> <input type="checkbox"/> <input type="checkbox"/> <input type="checkbox"/> <input type="checkbox"/> <input type="checkbox"/> <input type="checkbox"/> <input type="checkbox"/>	
	4. ROOM EFFECT 1 Room Reverb Time [s] 0.5 D022 E76 HD10 L+01 H100 40:60 <input type="checkbox"/> <input type="checkbox"/> <input type="checkbox"/> <input type="checkbox"/> <input type="checkbox"/> <input type="checkbox"/> <input type="checkbox"/> <input type="checkbox"/> <input type="checkbox"/> <input type="checkbox"/> <input type="checkbox"/> <input type="checkbox"/> <input type="checkbox"/> <input type="checkbox"/> <input type="checkbox"/> <input type="checkbox"/>	
	5. LARGE ROOM EFFECT 1 Large Room Reverb Time [s] 1.5 D030 E76 HD30 L+02 H+04 60:40 <input type="checkbox"/> <input type="checkbox"/> <input type="checkbox"/> <input type="checkbox"/> <input type="checkbox"/> <input type="checkbox"/> <input type="checkbox"/> <input type="checkbox"/> <input type="checkbox"/> <input type="checkbox"/> <input type="checkbox"/> <input type="checkbox"/> <input type="checkbox"/> <input type="checkbox"/> <input type="checkbox"/> <input type="checkbox"/>	

9. LIVE STAGE

EFFECT 1 Live Stage Reverb Time [s]  
 2.0 D020 E60 HD20 L+00 H+00 60:40  
 A  B  C  D  E  F  G  H

7. EARLY REFLECTION

(common to 7-9)

EFFECT 1 Early Ref 1 E/R Time [ms]  
 Time170 D030 L+00 H+00 60:40  
 A  B  C  D  E  F  G  H

8. EARLY REFLECTION 2

EFFECT 1 Early Ref 2 E/R Time [ms]  
 Time200 D020 L+00 H+00 60:40  
 A  B  C  D  E  F  G  H

9. EARLY REFLECTION 3

EFFECT 1 Early Ref 3 E/R Time [ms]  
 Time190 D010 L+00 H+00 60:40  
 A  B  C  D  E  F  G  H

DELAY

10. STEREO DELAY

(common to 10, 11)

EFFECT 1 Stereo DLY Time L [ms]  
 L250 R260 F+50 HD10 L+00 H+00 70:30  
 A  B  C  D  E  F  G  H

11. CROSS DELAY

EFFECT 1 Cross Delay Time L [ms]  
 L180 R360 F+80 HD10 L+00 H+00 70:30  
 A  B  C  D  E  F  G  H

CHORUS

12. STEREO CHORUS 1

(common to 12, 13)

EFFECT 1 Chorus 1 Mod Depth  
 M60 S0.30 D010 TRI L+00 H+00 60:40  
 A  B  C  D  E  F  G  H

13. STEREO CHORUS 2

EFFECT 1 Chorus 2 Mod Depth  
 M20 S2.40 D005 SIN L+00 H+00 60:40  
 A  B  C  D  E  F  G  H

FLANGER

14. STEREO FLANGER

(common to 14, 15)

EFFECT 1 Flanger Mod Depth  
 M70 S0.18 D00 F-75 SIN L+00 H+00 40:60  
 A  B  C  D  E  F  G  H

15. CROSS FLANGER

E: Modulation Waveform  
 F: Equalizer Low  
 G: Equalizer High  
 H: Effect Balance

EFFECT 1 X-Flanger Mod Depth  
 M37 S0.21 D25 F+80 SIN L+00 H+00 25:75  
 A  B  C  D  E  F  G  H

PHASER

16. PHASER 1

(common to 16, 17)

A: Manual  
 B: Modulation Speed  
 C: Modulation Depth  
 D: Feedback  
 E: Modulation Waveform  
 F: -----  
 G: -----  
 H: Effect Balance

EFFECT 1 Phaser 1 Manual 25:75  
 M89 S0.69 M60 F-75 SIN  
 A  B  C  D  E  F  G  H

17. PHASER 2

EFFECT 1 Phaser 2 Manual 60:40  
 M89 S0.57 M69 F+87 TRI  
 A  B  C  D  E  F  G  H

TREMOLO

18. STEREO TREMOLO 1

(common to 18, 19)

A: Modulation Depth  
 B: Modulation Speed  
 C: Modulation Waveform  
 D: Shape  
 E: -----  
 F: Equalizer Low  
 G: Equalizer High  
 H: Effect Balance

EFFECT 1 Tremolo 1 Mod Depth  
 M80 S1.59 SIN S+89 L+00 H+00 EFF  
 A  B  C  D  E  F  G  H

19. STEREO TREMOLO 2

EFFECT 1 Tremolo 2 Mod Depth  
 M63 S04.0 TRI S+00 L+00 H+00 EFF  
 A  B  C  D  E  F  G  H

EQUALIZER

20. EQUALIZER

A: Low Gain  
 B: -----  
 C: Low Frequency  
 D: -----  
 E: High Gain  
 F: High Frequency  
 G: -----  
 H: Effect Balance

EFFECT 1 Equalizer Low Gain [dB]  
 Low+00 500 High+00 2K EFF  
 A  B  C  D  E  F  G  H

OVER DRIVE

21. OVER DRIVE

A: Drive  
 B: Level  
 C: -----  
 D: -----  
 E: -----  
 F: Equalizer Low  
 G: Equalizer High  
 H: Effect Balance

EFFECT 1 Over Drive Drive  
 D080 L015 L+00 H+00 EFF  
 A  B  C  D  E  F  G  H

22. DISTORTION

EFFECT 1 Distortion Distortion  
 D080 L020 L+00 H+00 EFF  
 A  B  C  D  E  F  G  H

D:-----  
 E:-----  
 F: Equalizer Low  
 G:-----  
 H: Effect Balance

**EXCITER**  
 23. EXCITER

A: Blend  
 B:-----  
 C: Enphatic Point  
 D:-----  
 E:-----  
 F: Equalizer Low  
 G: Equalizer High  
 H: Effect Balance

EFFECT 1	Exciter	Blend	Delay Time [ms]
B499	EP05	L:100	H:400
[A]	[B]	[C]	[D]

**ENSEMBLE**

24. SYMPHONIC ENSEMBLE

A: Modulation Depth  
 B:-----  
 C:-----  
 D:-----  
 E:-----  
 F: Equalizer Low  
 G: Equalizer High  
 H: Effect Balance

EFFECT 1	Sympho Ens	Mod Depth	Delay Time [ms]
M60		L:100	H:50
[A]	[B]	[C]	[D]

**ROTARY SPEAKER**

25. ROTARY SPEAKER

A: Modulation Depth  
 B: Speed  
 C: Speed Ratio  
 D:-----  
 E:-----  
 F:-----  
 G:-----  
 H: Effect Balance

EFFECT 1	Rotary SP	Mod Depth	Eff
M62	FAST	R:105	
[A]	[B]	[C]	[D]

**EFFECT COMBINATION**

26. DELAY/HALL

A: Delay Time  
 B: Feedback  
 C: High Damp  
 D: Effect Balance  
 E: Reverb Time  
 F: Pre delay  
 G: High Damp  
 H: Effect Balance

EFFECT 1	Delay/Hall	Delay Time [ms]
D250	F:150	H:10
[A]	[B]	[C]

27. DELAY/ROOM

A: Delay Time  
 B: Feedback  
 C: High Damp  
 D: Effect Balance  
 E: Reverb Time  
 F: Pre delay  
 G: High Damp  
 H: Effect Balance

EFFECT 1	Delay/Room	Delay Time [ms]
D250	F:50	H:10
[A]	[B]	[C]

28. DELAY/EARLY REFLECTION

A: Delay Time  
 B: Feedback  
 C: High Damp  
 D: Effect Balance  
 E: Early Reflection  
 F: Pre delay  
 G:-----  
 H: Effect Balance

EFFECT 1	Delay/Ref	Delay Time [ms]
D250	F:50	H:10
[A]	[B]	[C]

29. DELAY/DELAY

A: Delay Time  
 B: Feedback  
 C: High Damp  
 D: Effect Balance  
 E: Delay Time  
 F: Feedback  
 G: High Damp  
 H: Effect Balance

EFFECT 1	Delay/Delay	Time L [ms]
250	F:50	H:10
[A]	[B]	[C]

30. DELAY/CHORUS

A: Delay Time  
 B: Feedback  
 C: High Damp  
 D: Effect Balance  
 E: Modulation Depth  
 F: Modulation Speed  
 G: Modulation Waveform  
 H: Effect Balance

EFFECT 1	DLV/Chorus	Delay Time [ms]
D250	F:150	H:10
[A]	[B]	[C]

31. DELAY/FLANGER

A: Delay Time  
 B: Feedback  
 C: High Damp  
 D: Effect Balance  
 E: Modulation Depth  
 F: Modulation Speed  
 G: Feedback  
 H: Effect Balance

EFFECT 1	DLV/Flanger	Delay Time [ms]
D250	F:150	H:10
[A]	[B]	[C]

4	MEMORY PROTECT	3 A, 3 B
4-1	EFFECT INTERLOCK	3 C
4-2	PAGE MEMORY	3 D
5	MIDI DATA DUMP	4 A
6	LOAD FROM CARD	5 A
7	SAVE TO CARD	5 B
8	FORMAT CARD	5 C
9	PRESET DATA LOAD	5 D

After executing in pages 5-9, press a key A-H to return to the previous display.

32. DELAY/PHASER	<p>A: Delay Time B: Feedback C: High Damp D: Effect Balance E: Modulation Depth F: Modulation Speed G: Feedback H: Effect Balance</p> <p>DELAY PHASER</p>
33. DELAY/TREMOLO	<p>A: Delay Time B: Feedback C: High Damp D: Effect Balance E: Modulation Depth F: Modulation Speed G: Shape H: Effect Balance</p> <p>DELAY TREMOLO</p>

0	GLOBAL mode (F5)	MERPAGE 0 A
1	MASTER TUNE/KEY TRANSPOSE	1 A, 1 B
1-1	SCALE TYPE	1 B~1 E
2	MIDI GLOBAL	2 A
3	MIDI FILTERING	2 B, 2 C

DRUMS mode (F6)

PAGE 0

MER 0 A~0 C

(common to 1~4)  
 A: Index  
 B: Instrument  
 C: Key  
 D: Tune  
 E: Level  
 F: Decay  
 G: Pan  
 H: -----

DRUM KIT 1  
 DRUM KIT1 Kick 1  
 #00 01 C2 +000 L+00 D-12 Pan=5:5

DRUM KIT 2  
 DRUM KIT2 Kick 1  
 #00 01 C2 +000 L+00 D-58 Pan=5:5

DRUM KIT 3  
 DRUM KIT3 Kick 3  
 #00 03 C2 -010 L+00 D+00 Pan=5:5

DRUM KIT 4  
 DRUM KIT4 Conga 1  
 #00 14 F3 -028 L+00 D+00 Pan=5:5

DEMO mode

PAGE

MER

SONGO-Lady Amazon

M3R MIDI IMPLEMENTATION

1. TRANSMITTED DATA ( DEMO PLAYING DATA in not transmitted)

1-1 CHANNEL MESSAGES

Status	Second	Third	Description	ENA
1000 nnnn	0kkk kkkk	0100 0000	Note Off	0
1001 nnnn	0kkk kkkk	0vvv vvvv	Note On vvv vvvv=1~127	0
1011 nnnn	0000 0001	0vvv vvvv	Pitch Modulation	CO
1011 nnnn	0000 0010	0vvv vvvv	VDF Modulation	CO
1011 gggg	0000 0110	0vvv vvvv	Data Entry (MSB) ( R.Editor Slider ) *1	ER
1011 nnnn	0000 0111	0vvv vvvv	Volume	CO
1011 gggg	0010 0110	0vvv vvvv	Data Entry (LSB) ( R.Editor Slider ) *1	ER
1011 nnnn	0100 0000	00vv vvvv	Damper Off	CO
1011 nnnn	0100 0000	01vv vvvv	Damper On	CO
1011 gggg	0101 0000	00vv vvvv	Rotary SP Effect Speed Slow	CO
1011 gggg	0101 0000	01vv vvvv	Rotary SP Effect Speed Fast	CO
1011 gggg	0110 0000	0000 0000	Data Increment ( Δ/YES Switch ) *1	E
1011 gggg	0110 0001	0000 0000	Data Decrement ( ▽/NO Switch ) *1	E
1100 nnnn	0ppp pppp	-----	Program Change (Program or Combi)	P
1101 nnnn	0vvv vvvv	-----	Channel Pressure	CO
1110 nnnn	0bbb bbbb	0bbb bbbb	Bender Change	CO

nnnn : MIDI Channel No. (0~15) Usually Global Channel. When using MIDI Overflow, each MIDI channel  
 gggg : MIDI Channel No. (0~15) Always Global Channel.

ENA = A : Always Enabled

P : Enabled when Program Change ENA

0 : Enabled when Overflow is On

C : Enabled when Control Change ENA

E : Enabled when Exclusive ENA

R : Enabled when Remote Editor is connected

CO : C AND 0

EO : E AND 0

ER : E AND R

\*1 : Except GLOBAL DEMO Mode

1-2 SYSTEM REALTIME MESSAGES

Status	Description
1111 1110	Active Sensing

2-1 CHANNEL MESSAGES

Status	Second	Third	Description	ENA
1000 nnnn	0Rkk kkkk	0xxx xxxx	Note Off	A
1001 nnnn	0Ekk kkkk	0000 0000	Note Off	A
1001 nnnn	0kkk kkkk	0vvv vvvv	Note On vvv vvvv=1~127	A
1011 nnnn	0000 0001	0vvv vvvv	Pitch Modulation	C
1011 nnnn	0000 0010	0vvv vvvv	VDF Modulation	C
1011 gggg	0000 0110	0vvv vvvv	Data Entry (MSB)	E
1011 nnnn	0000 0111	0vvv vvvv	Volume	C
1011 gggg	0010 0110	0vvv vvvv	Data Entry (LSB)	E
1011 nnnn	0100 0000	00xx xxxx	Damper Off	C
1011 nnnn	0100 0000	01xx xxxx	Damper On	C
1011 gggg	0101 0000	00xx xxxx	Rotary Effect Speed Slow	C
1011 gggg	0101 0000	01xx xxxx	Rotary Effect Speed Fast	C
1011 gggg	0110 0000	0000 0000	DATA Increment	E
1011 gggg	0110 0001	0000 0000	DATA Decrement	E
1011 gggg	0110 0100	0000 0001	RPC Parameter No.(LSB) (M.Tune) *3	E
1011 gggg	0110 0101	0000 0000	RPC Parameter No.(MSB) (M.Tune) *3	E
1011 nnnn	0111 1011	0000 0000	All Notes Off	A
1011 nnnn	0111 110x	0000 0000	(All Notes Off)	A
1011 nnnn	0111 1110	0000 nnnn	(All Notes Off) n nnnn=0~10	A
1011 nnnn	0111 1111	0000 0000	(All Notes Off)	A
1100 gggg	0ppp pppp	-----	Combination, Program Change	P
1100 nnnn	0ppp pppp	-----	Program Change	P
1101 nnnn	0vvv vvvv	-----	Channel Pressure	C
1110 nnnn	0bbb bbbb	0bbb bbbb	Bender Change	C

nnnn : MIDI Channel No. (0~15) Usually Global Channel. In MULTI Mode, MIDI channel for each.  
 gggg : MIDI Channel No. (0~15) Global Channel only.  
 x : Don't care

- ENA ..... Same as TRANSMITTED DATA
- \*2 : Except in GLOBAL( Active at MASTER TUNE ), DEMO Mode
- \*3 : After a received message has been processed (While Exclusive On),  
 Transmits Exclusive Message[DATA LOAD COMPLETED]or[DATA LOAD ERROR]
- \*4 : Usually selects a Combination. When in PROGRAM EDIT Mode, selects a Program.

1-4 SYSTEM EXCLUSIVE MESSAGES ( Both Transmitted and Received )

Byte (hex)	Description
1111 0000 (F0)	EXCLUSIVE STATUS
0111 1110 (7E)	NON REALTIME MESSAGE
0000 **** (0*)	MIDI GLOBAL CHANNEL ( DEVICE ID )
0000 0110 (06)	INQUIRY MESSAGE
0000 0010 (02)	IDENTITY REPLY
0100 0010 (42)	KORG ID
0010 0100 (24)	*3R ID
0000 0000 (00)	( MANUFACTURERS ID )
0000 0000 (00)	( FAMILY CODE(LSB) )
0000 0000 (00)	( MEMBER CODE(LSB) )
0000 0000 (00)	( - - (MSB) )
0*** **** (**)	( ROM No. 1~ )
0000 0000 (00)	( Minor Ver.(LSB) )
0*** **** (**)	( - - (MSB) )
0000 0000 (00)	( SOFT VER. 1~ )
0*** **** (**)	( Major Ver.(LSB) )
0000 0000 (00)	( - - (MSB) )
1111 0111 (F7)	END OF EXCLUSIVE

Transmitted when an INQUIRY MESSAGE REQUEST is received.

- 1st Byte = 1111 0000 (F0) : Exclusive Status
- 2nd Byte = 0100 0010 (42) : KORG ID
- 3rd Byte = 0011 nnnn (3g) : Format ID g:Global ch
- 4th Byte = 0010 0100 (24) : MGR ID
- 5th Byte = 0fff ffff (ff) : Function Code
- 6th Byte = 0ddd dddd (dd) : Data
- .....
- Last Byte = 1111 0111 (F7) : End of Exclusive ..... 80X

Func	Description	R	C	D	E
42	MODE DATA	○	○	○	○
47	DRUMS SOUND(PCB CARD) NAME	○	○	○	○
45	MULTISOUND(PCB CARD) NAME	○	○	○	○
4E	MODE CHANGE	○	○	○	○
41	PARAMETER CHANGE	○	○	○	○
40	PROGRAM PARAMETER DUMP	○	○	○	○
4C	ALL PROGRAM PARAMETER DUMP	○	○	○	○
48	COMBINATION PARAMETER DUMP	○	○	○	○
4D	ALL COMBINATION PARAMETER DUMP	○	○	○	○
31	GLOBAL DATA DUMP	○	○	○	○
52	DRUMS DATA DUMP	○	○	○	○
50	ALL DATA(GLB. DRUM, CHG. PRO) DUMP	○	○	○	○
26	RECEIVED MESSAGE FORMAT ERROR	○	○	○	○
23	DATA LOAD COMPLETED	○	○	○	○
24	DATA LOAD ERROR	○	○	○	○
21	WRITE COMPLETED	○	○	○	○
22	WRITE ERROR	○	○	○	○

- R : Request Message is received
- C : Mode or No. is changed by SW
- D : Data dump by SW
- E : EV Message is received
- ( does not respond to Exclusive On, Off )

2-2 SYSTEM REALTIME MESSAGES

Status	Description
1111 1110	Active Sensing

2-3 UNIVERSAL SYSTEM EXCLUSIVE MESSAGE (DEVICE INQUIRY REQUEST)

Byte	Description
1111 0000 (F0)	EXCLUSIVE STATUS
0111 1110 (7E)	NOM REALTIME MESSAGE
0*** *** (**) (Device ID) #5	MIDI CHANNEL
0000 0110 (05)	INQUIRY MESSAGE
0000 0001 (01)	INQUIRY REQUEST
1111 0111 (F7)	END OF EXCLUSIVE

\*5 = 0~F : Received on the Global Channel  
 \* 7F : Received on any Channel

2-4 SYSTEM EXCLUSIVE MESSAGES

Function Code List

Func	Description	G	C	P	No.
12	MODE REQUEST	○	○	○	42
1F	DRUMS SOUND(PCM CARD) NAME DUMP REQUEST	○	○	○	47
16	MULTISOUND(PCM CARD) NAME DUMP REQUEST	○	○	○	45
10	PROGRAM PARAMETER DUMP REQUEST	○	○	○	40
1C	ALL PROGRAM PARAMETER DUMP REQUEST	◎	○	○	4C
19	COMBINATION PARAMETER DUMP REQUEST	◎	○	○	49
1D	ALL COMBINATION PARAMETER DUMP REQUEST	◎	○	○	4D
0E	GLOBAL DATA DUMP REQUEST	◎	○	○	51
0D	DRUMS DATA DUMP REQUEST	◎	○	○	52
0F	ALL DATA(GLOBAL, DRUM, COMB, PROG)DUMP REQUEST	◎	○	○	50
11	PROGRAM WRITE REQUEST	○	○	○	21
1A	COMBINATION WRITE REQUEST	○	○	○	21
40	PROGRAM PARAMETER DUMP	○	○	○	23
4C	ALL PROGRAM PARAMETER DUMP	◎	○	○	23
49	COMBINATION PARAMETER DUMP	◎	○	○	23
4D	ALL COMBINATION PARAMETER DUMP	◎	○	○	23
51	GLOBAL DATA DUMP	◎	○	○	23
52	DRUMS DATA DUMP	◎	○	○	23
50	ALL DATA(GLOBAL, DRUMS, COMBI, PROG) DUMP	◎	○	○	23
4E	MODE CHANGE	○	○	○	23
41	PARAMETER CHANGE	○	○	○	23

3. MIDI EXCLUSIVE MESSAGE FORMAT

R : Received, T : Transmitted

(1) MODE REQUEST R

Byte	Description
F0.42.3n.24	EXCLUSIVE HEADER
0001 0010	MODE REQUEST
1111 0111	EOX

12H

Receives this message, and transmits Func=42 message.

(2) DRUMS SOUND(PCM Card) NAME DUMP REQUEST R

Byte	Description
F0.42.3n.24	EXCLUSIVE HEADER
0001 1111	DRUMS SOUND(Card) NAME DUMP REQ. 1FH
1111 0111	EOX

Receives this message, and transmits Func=47 or Func=24 message.

(3) MULTISOUND(PCM Card) NAME DUMP REQUEST R

Byte	Description
F0.42.3n.24	EXCLUSIVE HEADER
0001 0110	MULTISOUND(Card) NAME DUMP REQ. 16H
1111 0111	EOX

Receives this message, and transmits Func=45 or Func=24 message.

(4) PROGRAM PARAMETER DUMP REQUEST R

Byte	Description
F0.42.3n.24	EXCLUSIVE HEADER
0001 0000	PROGRAM PARAMETER DUMP REQUEST 10H
1111 0111	EOX

Receives this message, and transmits Func=40 or Func=24 message.

(5) ALL PROGRAM PARAMETER DUMP REQUEST R

Byte	Description
F0.42.3n.24	EXCLUSIVE HEADER
0001 1100	ALL PROGRAM PARAMETER DUMP REQUEST 1CH
0000 000c	Bank
1111 0111	EOX

(See NOTE 3)

Receives this message, and transmits Func=4C or Func=24 message.

(6) COMBINATION PARAMETER DUMP REQUEST R

Byte	Description
F0.42.3n.24	EXCLUSIVE HEADER
0001 1001	COMBINATION PARAMETER DUMP REQUEST 19H
1111 0111	EOX

Receives this message, and transmits Func=49 or Func=24 message.

(7) ALL COMBINATION PARAMETER DUMP REQUEST R

Byte	Description
F0.42.3n.24	EXCLUSIVE HEADER
0001 1101	ALL COMBI. PARAMETER DUMP REQUEST 1DH
0000 000c	Bank
1111 0111	EOX

(See NOTE 3)

Receives this message, and transmits Func=4D or Func=24 message.

Received when in  
 G : GLOBAL, DRUMS MODE  
 (○) : Does not respond to Exclusive On, Off in DATA DUMP Page)  
 C : COMBI, COMBI E-EFF MODE  
 P : PROG E MODE  
 No. : MIDI Out Function No. transmitted after the message has been received.



(8) GLOBAL DATA DUMP REQUEST R

Byte	Description
F0.42.3n.24	EXCLUSIVE HEADER
0000 1110	GLOBAL DATA DUMP REQUEST (See NOTE 3)
0000 000c	Bank
1111 0111	EOX

Receives this message, and transmits Func-51 or Func-24 message.

(9) DRUMS DATA DUMP REQUEST R

Byte	Description
F0.42.3n.24	EXCLUSIVE HEADER
0000 1101	DRUMS DATA DUMP REQUEST (See NOTE 3)
0000 000c	Bank
1111 0111	EOX

Receives this message, and transmits Func-52 or Func-24 message.

(10) ALL DATA(GLOBAL, DRUMS, COMBI, PROG) DUMP REQUEST R

Byte	Description
F0.42.3n.24	EXCLUSIVE HEADER
0000 1111	ALL DATA(GLB, DRM, CMB, PRG) DUMP REQ. OPH (See NOTE 3)
0000 000c	Bank
1111 0111	EOX

Receives this message, and transmits Func-50 or Func-24 message

(11) PROGRAM WRITE REQUEST R

Byte	Description
F0.42.3n.24	EXCLUSIVE HEADER
0001 0001	PROGRAM WRITE REQUEST (See NOTE 3)
0000 000c	Bank
0ppp pppp	Write Program No.(0~99)
1111 0111	EOX

Receives this message, and writes the data and transmits Func-21 or Func-22 message.

(12) COMBINATION WRITE REQUEST R

Byte	Description
F0.42.3n.24	EXCLUSIVE HEADER
0001 1010	COMBINATION WRITE REQUEST (See NOTE 3)
0000 000c	Bank
0ppp pppp	Write Combination No.(0~99)
1111 0111	EOX

Receives this message, and writes the data and transmits Func-21 or Func-22 message.

(13) PROGRAM PARAMETER DUMP R, T

Byte	Description
F0.42.3n.24	EXCLUSIVE HEADER
0100 0000	PROGRAM PARAMETER DUMP (See NOTE 6)
0ddd dddd	Data (86Byte)
1111 0111	EOX

Receives this message & data, and transmits Func-23 or Func-24 message.  
Receives Func-10 message, and transmits this message & data.  
When the Program is selected No. by SW, this message & data is transmitted.

(14) ALL PROGRAM PARAMETER DUMP R, T

Byte	Description
F0.42.3n.24	EXCLUSIVE HEADER
0100 1100	ALL PROGRAM PARAMETER DUMP (See NOTE 3)
0000 000c	Bank
0ddd dddd	Data (8572Byte)
1111 0111	EOX

Receives this message & data, and transmits Func-23 or Func-24 message.  
Receives Func-1C message, and transmits this message & data.  
Transmits this message & data when DATA DUMP is executed.

(15) COMBINATION PARAMETER DUMP R, T

Byte	Description
F0.42.3n.24	EXCLUSIVE HEADER
0100 1001	COMBINATION PARAMETER DUMP (See NOTE 8)
0ddd dddd	Data (1448Byte)
1111 0111	EOX

Receives this message & data, and transmits Func-23 or Func-24 message.  
Receives Func-19 message, and transmits this message & data.  
When the Combi No. is selected by SW, this message & data is transmitted.

(16) ALL COMBINATION PARAMETER DUMP R, T

Byte	Description
F0.42.3n.24	EXCLUSIVE HEADER
0100 1101	ALL COMBINATION PARAMETER DUMP 4DH (See NOTE 3)
0000 000c	Bank
0ddd dddd	Data (14400Byte)
1111 0111	EOX

Receives this message & data, and transmits Func-23 or Func-24 message.  
Receives Func-1D message, and transmits this message & data.  
Transmits this message & data when DATA DUMP is executed.

(17) GLOBAL DATA DUMP R, T

Byte	Description
F0.42.3n.24	EXCLUSIVE HEADER
0101 0001	GLOBAL DATA DUMP (See NOTE 3)
0000 000c	Bank
0ddd dddd	Data (24Byte)
1111 0111	EOX

Receives this message & data, and transmits Func-23 or Func-24 message.  
Receives Func-0E message, and transmits this message & data.  
Transmits this message & data when DATA DUMP is executed

(18) DRUMS DATA DUMP R, T

Byte	Description
FO. 42. 3n. 24	EXCLUSIVE HEADER
0101 0010	DRUMS DATA DUMP 52H
0000 000c	Bank (See NOTE 3)
00dd dddd	Data (960Byte) (See NOTE 11)
1111 0111	EOX

Receives this message & data, and transmits Func=23 or Func=24 message.  
Receives Func=0D message, and transmits this message & data.  
Transmits this message & data when DATA DUMP is executed.

(19) ALL DATA(GLOBAL, DRUMS, COMBI, PROG) DUMP R, T

Byte	Description
FO. 42. 3n. 24	EXCLUSIVE HEADER
0101 0000	ALL DATA(GLB, DRM, CHR, PRG) DUMP 50H
0000 000c	Bank (See NOTE 3)
00dd dddd	Data (23956Byte) (See NOTE 12)
1111 0111	EOX

Receives this message & data, and transmits Func=23 or Func=24 message.  
Receives Func=0F message, and transmits this message & data.  
Transmits this message & data when DATA DUMP is executed.

(20) MODE CHANGE R, T

Byte	Description
FO. 42. 3n. 24	EXCLUSIVE HEADER
0100 1110	MODE CHANGE 4EH
000b rmm	Mode Data (See NOTE 1, 2)
000b 000c	Bank (See NOTE 2, 3)
1111 0111	EOX

Receives this message & data, and changes the Mode, Bank and transmits Func=23 or Func=24 message.  
When the Mode is changed by SW, transmits this message & data(b of Mode=0, b of Bank=1).  
When the Controller(M3R or RE1) is changed, transmits this message & data (b of Bank & Mode=1).  
When the Bank is changed by SW, transmits this message & data(b of Mode=1, b of Bank=0).

(21) PARAMETER CHANGE R, T

Byte	Description
FO. 42. 3n. 24	EXCLUSIVE HEADER
0100 0001	PARAMETER CHANGE 41H
0ppp pppp	Parameter No. (See TABLE 5)
0vvv vvvv	Value (bit6-0) (See NOTE 13)
0vvv vvvv	Value (bit15-7) (See NOTE 13)
1111 0111	EOX

Receives this message & data, and transmits Func=23 or Func=24 message.  
When the Parameter No. is changed by SW, and transmits this message & data.

(22) MODE DATA T

Byte	Description
FO. 42. 3n. 24	EXCLUSIVE HEADER
0100 0010	MODE DATA 42H
0000 rmm	Mode Data (See NOTE 1)
0011 00mm	Card Variation (See NOTE 4)
0000 00cc	PCM Card Variation (See NOTE 5)
1111 0111	EOX

Receives Func=12 message, and transmits this message & data.

(23) DRUM SOUND(PCM Card) NAME T

Byte	Description
FO. 42. 3n. 24	EXCLUSIVE HEADER
0100 0111	DRUM SOUND(PCM Card) NAME 47H
0sss ssss	Drum Sound Number (See NOTE 14)
00dd dddd	Data (See NOTE 14)
1111 0111	EOX

Receives Func=1F message, and transmits this message & data, or transmits Func=24 message.

(24) MULTISOUND(PCM Card) NAME T

Byte	Description
FO. 42. 3n. 24	EXCLUSIVE HEADER
0100 0101	MULTISOUND(PCM Card) NAME 45H
0sss ssss	Multi Sound Number (See NOTE 15)
00dd dddd	Data (See NOTE 15)
1111 0111	EOX

Receives Func=16 message, and transmits this message & data, or transmits Func=24 message.

(25) MIDI IN DATA FORMAT ERROR T

Byte	Description
FO. 42. 3n. 24	EXCLUSIVE HEADER
0010 0110	MIDI IN DATA FORMAT ERROR 26H
1111 0111	EOX

Transmits this message when there is an error in the MIDI IN message (ex. data length).

(26) DATA LOAD COMPLETED T

Byte	Description
FO. 42. 3n. 24	EXCLUSIVE HEADER
0010 0011	DATA LOAD COMPLETED 23H
1111 0111	EOX

Transmits this message when DATA LOAD, PROCESSING have been completed.

(27) DATA LOAD ERROR T

Byte	Description
FO. 42. 3n. 24	EXCLUSIVE HEADER
0010 0100	DATA LOAD ERROR 24H
1111 0111	EOX

Transmits this message when DATA LOAD, PROCESSING have failed (ex. protected).

(28) WRITE COMPLETED T

Byte	Description
FO. 42. 3n. 24	EXCLUSIVE HEADER
0010 0001	WRITE COMPLETED 21H
1111 0111	EOX

Transmits this message when DATA WRITE MIDI has been completed.

(29) WRITE ERROR T

Byte	Description
FO. 42. 3n. 24	EXCLUSIVE HEADER
0010 0010	WRITE ERROR 22H
1111 0111	EOX

Transmits this message when DATA WRITE MIDI has failed.

NOTE 1 : mm = 0 : COMBINATION PLAY 3 : GLOBAL  
 1 : COMBINATION EDIT 4 : PROGRAM EDIT  
 2 : EFFECT 5 : DRUMS  
 6 : DEMO PLAY ( Not received )  
 r = 0 : Normal  
 1 : Remote Controlled

NOTE 2 : b = 0 : Change the Mode.Bank  
 = 1 : Don't change the Mode.Bank

NOTE 3 : c = 0 : Internal  
 = 1 : Card

NOTE 4 : tt.nmm = 0,0 : Card Off  
 = 0,1 : MG Card (ROM)  
 = 0,2 : - - (RAM)  
 = 1,0 : ROM Card  
 = 2,0 : RAM Card (Protect Off)  
 = 3,0 : - - ( 0n )

NOTE 5 : cc = 0 : Card Off  
 = 1 : MG Card  
 = 2 : PCK Card In

DUMP DATA FORMAT n=0~ For NOTE 6, 7, 8, 9, 10, 11, 12, 14, 15

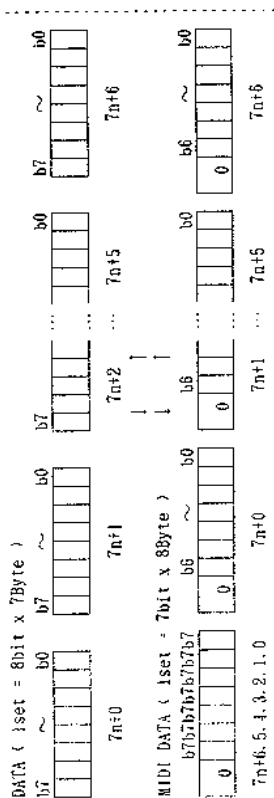

NOTE 6 : PROGRAM PARAMETER DUMP FORMAT  
 (Parameter No.00).....[Parameter No.74]  
 75Byte = 7x10+5 → 8x10+(1+5) = 88Byte  
 ( See TABLE 1 )

NOTE 7 : ALL PROGRAM PARAMETER DUMP FORMAT  
 [Prog. No.00 (75Byte)].....[Prog. No.99 (75Byte)]  
 7500Byte = 7x1071+3 → 8x1071+(1+3) = 8572Byte ( 2.75Sec )

NOTE 8 : COMBINATION PARAMETER DUMP FORMAT  
 [Parameter No.00].....[Parameter No.125]  
 126Byte = 7x18+0 → 8x18 = 144Byte  
 ( See TABLE 2 )

NOTE 9 : ALL COMBINATION PARAMETER DUMP FORMAT

[Combi. No.00 (126Byte)].....[Combi. No.99 (126Byte)]  
 12600Byte = 7x1800+0 → 8x1800 = 14400Byte ( 4.55Sec )

NOTE 10 : GLOBAL DATA DUMP FORMAT  
 [Global Data (218Byte)]  
 218Byte = 7x31+0 → 8x3 = 24Byte  
 ( See TABLE 3 )

NOTE 11 : DRUMS DATA DUMP FORMAT  
 [Drums Data (7x30x4Byte)]  
 840Byte = 7x120+0 → 8x120 = 960Byte ( 0.35Sec )  
 ( See TABLE 4 )

NOTE 12 : ALL DATA (GLOBAL, DRUMS, COMBI. PROG) DUMP FORMAT  
 [Global Data] (See NOTE 10).  
 [Drums Data] (See NOTE 11).  
 [All Combination Parameter Data] (See NOTE 9).  
 [All Program Parameter Data] (See NOTE 7)  
 21+840+12600+7500Byte = 7x2994+3 → 8x2994+(1+3) = 23956Byte ( 7.75Sec )

NOTE 13 : VALUE DATA FORMAT ( Use at Func=41:PARAMETER CHANGE )

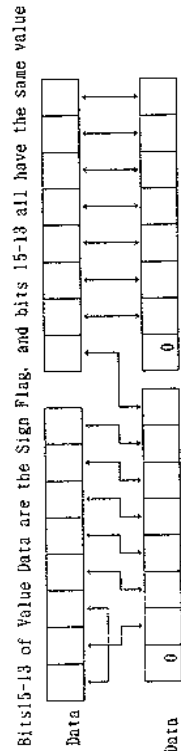

Bits15-13 of Value Data are the Sign Flag, and bits 15-13 all have the same value  
 NOTE 14 : DRUM SOUND(PCK Card) NAME DATA FORMAT  
 [Drum Sound 1 Name (10Byte)], .....,[Drum Sound n Name (10Byte)]  
 n : Drum Sound Number

NOTE 15 : MULTISOUND(PCK Card) NAME DATA FORMAT  
 [Multisound 1 Name (10Byte)], .....,[Multisound n Name (10Byte)]  
 n : Multisound Number

M3R PROGRAM PARAMETERS (TABLE 1)

Table with 3 columns: No., PARAMETER, DATA(HEX) : VALUE. Rows include parameters like OSCILLATOR, ASSIGN, HOLD, MULTISOUND/DRUM KIT No., DELAY START, PITCH MG, WAVE FORM, KEY SYNC, FREQUENCY, DELAY, INTENSITY, CUTOFF MG, WAVE FORM (MG ENABLE), KEY SYNC, FREQUENCY, DELAY, INTENSITY, PITCH, PITCH MG, VDF CUTOFF, VDF MG, VDA AMPLITUDE, CONTROLLER, PITCH BEND, VDF SWEEP INT, PITCH MG FREQUENCY, VDF MG INT, VDF MG FREQUENCY.

\*1 : bit0 : ATTACK TIME SW =0:OFF, =1:ON
bit1 : DECAY TIME SW =0:OFF, =1:ON
bit2 : SLOPE TIME SW =0:OFF, =1:ON
bit3 : RELEASE TIME SW =0:OFF, =1:ON
bit4 : ATTACK TIME POLARITY =0:+, =1:-
bit5 : DECAY TIME POLARITY =0:+, =1:-
bit6 : SLOPE TIME POLARITY =0:+, =1:-
bit7 : RELEASE TIME POLARITY =0:+, =1:-

\*2-1 : 0 : MULTI SOUND
2 : DRUM

\*2-2 : When MULTISOUND 0~59 : Int0~89, 5A~ : Card0~
When DRUM KIT 0~3 : Int1~4, 4~7 : Card1~4

\*3 : 0 : TRIANGLE ( ^ )
1 : UP SAW ( / )
2 : DOWN SAW ( \ )
3 : RECTANGLE ( J )

COMBINATION PARAMETER (TABLE 2)

Table with 3 columns: No., PARAMETER, DATA(HEX) : VALUE. Rows include COMBI. NAME (Head), COMBI. NAME (Tail), COMBINATION TYPE, EFFECT PARAMETER, EFFECT 1 PATTERN No., L-CR BALANC, R-CH, B-CH, OUTPUT 3 PAN, EFFECT 1/0, EFFECT 1 PARAMETER, EFFECT 2 PARAMETER, TIMBRE 1 PARAMETER, PROGRAM NO., OUTPUT LEVEL, KEY TRANSPOSE, DEJUNE, TIMBRE, INST, PAN, KEY WINDOW TOP, KEY WINDOW BOTTOM, VEL WINDOW TOP, VEL WINDOW BOTTOM, CONTROL FILTER, TIMBRE ON OFF, KIDI CHANNEL, TIMBRE 2~3 PARAMETER.

\*4 : 0 : SINGLE
1 : LAYER
2 : SPLIT
3 : VEL SW
4 : MULTI
\*5 : 00 : 10:00
0A : 00:10
0B : C
0C : C/D
0D : D
\*6 : bit0 : PROGRAM CHANGE =0:DIS, =1:ENA
bit1 : AFTER TOUCH =0:DIS, =1:ENA
bit2 : CONTROL CHANGE =0:DIS, =1:ENA
bit3 : DAMPER =0:DIS, =1:ENA

GLOBAL PARAMETER (TABLE 3)

Table with 3 columns: No., PARAMETER, DATA(HEX) : VALUE. Rows include MASTER TUNE, KEY TRANSPOSE, EFFECT INTERLOCK, SCALE TYPE, PURE TYPE KEY, USER SCALE.

DRUMS DATA (TABLE 4)

Table with 3 columns: No., PARAMETER, DATA(HEX) : VALUE. Rows include INSTRUMENT NO., KEY, PAN, TUNE, LEVEL, DECAY, DRUM KIT1-INDEX1 ~ DRUM KIT4-INDEX29.

\*7 : 0 : EQUAL
1 : RANDOM
2 : PURE MAJOR
3 : PURE MINOR
4 : USER SCALE

\*8 : If Combination Type is MULTI, Parameter Change Format is as follows:
00H : TIMBRE OFF
01H : 100
64H : 199
65H : C00
C8H : C99
00H : 100
63H : 199
64H : C00
C7H : C99

In any other case:

\*9 : 00 : Off \*10 :  
01 : L bit0=0:Effect L-Ch Off: 1:0n  
02 : R bit1=0: - 1 R-Ch Off: 1:0n  
03 : bit2=0: - 2 L-Ch Off: 1:0n  
04 : bit3=0: - 2 R-Ch Off: 1:0n  
05 : bit4=0: Effect Para.: Serial

EFFECT PARAMETERS

\*11 : Effect Parameter (8Byte) 33 Type

offset	PARAMETER	DATAREX VALUE
1~3	Reverb Time ( 4.5 : Room, 6 : Live Stage )	00~63 ( 30 : 0.2~9.9(5)
(01)	( NULL )	00
(02)	High Damp	00~63 : 00~99
(03)	Pre Delay	00~C8 : 00~200
(04)	E/R Level	00~63 : 00~99
(05)	( NULL )	00
(06)	EQ High	F4~0C : -12~12
(07)	EQ Low	F4~0C : -12~12

NULLs are omitted from the following next table.  
They should be set to 00 when received.

7~9 : Early Reflection 1, 2, 3

(00)	E/R Time	00~46 : 100~800
(01)	Pre Delay	00~C8 : 00~200
(02)	EQ High	F4~0C : -12~12
(03)	EQ Low	F4~0C : -12~12
(04)	Stereo Delay, 11 : Cross Delay	
(00)	Delay Time L (L)	00~1F4 : 00~500
(01)	( H )	
(02)	Feed Back	9D~63 : -99~99
(03)	High Damp	00~63 : 00~99
(04)	Delay Time R (L)	00~1F4 : 00~500
(05)	( H )	
(06)	EQ High	F4~0C : -12~12
(07)	EQ Low	F4~0C : -12~12

12, 13 : Stereo Chorus 1, 2. ( L1, L5 : Flanger )

(00)	Depth	00~63 : 00~99
(01)	Speed	00~D8 *11-3-2
(02)	LFO Status	*11-1 bit1 ← 1
(03)	( Feedback )	bit2 ← 0 (1)
(04)	Delay Time	0~C8:32:0~200:50
(05)	EQ High	F4~0C : -12~12
(06)	EQ Low	F4~0C : -12~12

15 : Phase Shifter 1. ( L1 : Phase Shifter 2 )

(00)	Depth	00~63 : 00~99
(01)	Speed	00~D8 *11-3-2
(02)	LFO Status	*11-1 bit1 ← 0 (1)
(03)	Feedback	9D~63 : -99~99
(04)	Manual	00~63 : 00~99

18 : Stereo Tremolo 1. ( L9 : Stereo Tremolo 2 )

(00)	Depth	00~63 : 00~99
(01)	Speed	00~D8 *11-3-2
(02)	LFO Status	*11-1 bit0=0:Sin.:1:Tri bit1 ← 0 (1) bit2 ← 0
(03)	Shape	9D~63 : -99~99
(04)	EQ High	F4~0C : -12~12
(05)	EQ Low	F4~0C : -12~12
(06)	Delay Parameter	

20 : Equalizer

(04)	Low fc	0.1, 2: 0.25k: 0.5k: 1k
(05)	High fc	0.1, 2 : 1k, 2k, 4k
(06)	High Gain	F4~0C : -12~12
(07)	Low Gain	F4~0C : -12~12
21 : Over Drive		
(02)	Drive	00~63 : 00~99
(03)	Level	00~63 : 00~99
(06)	EQ High	F4~0C : -12~12
(07)	EQ Low	F4~0C : -12~12

22 : Distortion

(02)	Distortion	00~63 : 00~99
(03)	Level	00~63 : 00~99
(07)	EQ Low Gain	F4~0C : -12~12

23 : Exciter

(00)	Blend	9D~63 : -99~99
(01)	Emphatic Point	00~09 : 01~10
(06)	EQ High	F4~0C : -12~12
(07)	EQ Low	F4~0C : -12~12

24 : Symphonic Ensemble

(00)	Depth	00~63 : 00~99
(06)	EQ High	F4~0C : -12~12
(07)	EQ Low	F4~0C : -12~12

25 : Rotary Speaker

(00)	Depth	00~63 : 00~99
(01)	Speed	0.1 : Slow, Fast
(02)	Speed Rate	8C~14 : -20~20
26 : Delay / Hall		
(00)	Delay Parameter	*11-3
(03)		
(04)	Reverb Time	00~63 : 0.2~9.9
(06)	High Damp	00~63 : 00~99
(07)	Pre Delay	00~96 : 00~150
27 : Delay / Room		
(00)	Delay Parameter	*11-3
(03)		
(04)	Reverb Time	00~63 : 0.2~3.0
(06)	High Damp	00~63 : 00~99
(07)	Pre Delay	00~96 : 00~150
28 : Delay / Early Reflection		
(00)	Delay Parameter	*11-3
(03)		
(04)	E/R Time	00~1E : 100~400
(05)	Pre Delay	00~96 : 00~150

29 : Delay / Delay

(00)	Delay Time L (L)	00~1F4 : 00~500
(01)	( H )	
(02)	Feedback	9D~63 : -99~99
(03)	High Damp	00~63 : 00~99
(04)	Delay Time R (L)	00~1F4 : 00~500
(05)	( H )	
(06)	Feedback	9D~63 : -99~99
(07)	High Damp	00~63 : 00~99
(08)	Delay / Chorus. ( 31 : Delay / Flanger )	
(00)	Delay Parameter	*11-3
(03)		
(04)	Depth	00~63 : 00~99
(05)	Speed	00~D8 *11-2
(06)	LFO Status	*11-3-3 bit1 ← 0 bit2 ← 0 (1)
(07)	Feedback	9D~63 : -99~99

32 : Delay / Phaser

(00)	Delay Parameter	*11-3
(03)		
(04)	Depth	00~63 : 00~99
(05)	Speed	00~D8 *11-3-2
(06)	Feedback	9D~63 : -99~99

33 : Delay / Tremolo

(00)	Delay Parameter	*11-3
(03)		
(04)	Depth	00~63 : 00~99
(05)	Speed	00~D8 *11-3-2
(06)	Feedback	9D~63 : -99~99
(07)	Shape	9D~63 : -99~99

\*11-1 : LFO Status  
bit0 : Wave Form (0:Sin.:1:Tri)  
bit1 : Phase (0:0:1:2:3:4:5:6:7:8:9)  
bit2 : Wave Stage (0:Normal:1:Flanger)

\*11-2 : DataHex Value:Hex  
00~63 0:03~3:06 0:3step  
64~C7 3:1~3:3 0 0 : step  
C8~98 1:1~3:0 0 1 : step

\*11-3 : Delay Parameter

(00)	Delay Time L	00~1F4 : 00~500
(02)	Feedback	9D~63 : -99~99
(03)	High Damp	00~63 : 00~99

M3R PARAMETER No. — OFFSET ( TABLE 5 )

No. : Number used for a PARAMETER CHANGE ( Func = 41 )  
OFFSET: Number indicated in TABLE 1, 2, 4

PROGRAM PARAMETER

Table with 5 columns: No., PARAMETER, M3R, REL, OFFSET. Rows include OSCILLATOR, ASSIGN, HOLD, MULTISOUND No., OCTAVE, DELAY START, PITCH MG, WAVE FORM, KEY SYNC, FREQUENCY, DELAY, INTENSITY, CUTOFF MG, WAVE FORM, KEY SYNC, FREQUENCY, DELAY, INTENSITY, AFTER TOUCH, PITCH, PITCH MG, VDF CUTOFF, VDF MG, VDA AMPLITUDE, CONTROLLER, PITCH BEND, VDF SLEEP INTENSITY, PITCH MG INTENSITY, PITCH MG FREQUENCY, VDF MG INTENSITY, VDF MG FREQUENCY, PITCH EG, START LEVEL, ATTACK TIME, ATTACK LEVEL, DECAY TIME, DECAY LEVEL, RELEASE TIME, RELEASE LEVEL, VDA EG TIME XBD TRK SWAPOLARITY, ATTACK, SLOPE, RELEASE, VDF EG TIME XBD TRK SWAPOLARITY, ATTACK, SLOPE, RELEASE, VDA EG TIME VEL SENSE SWAPOLARITY, ATTACK, SLOPE, RELEASE.

Table with 5 columns: VDF EG, PARAMETER, M3R, REL, OFFSET. Rows include ATTACK TIME, DECAY TIME, BREAK POINT, SUSTAIN LEVEL, RELEASE TIME, RELEASE LEVEL, VDA, OSCILLATOR LEVEL, XBD TRK CENTER KEY, AMP XBD TRK INT, AMP XBD TRK SENSE, EG TIME XBD TRK SENSE, ATTACK TIME, ATTACK LEVEL, DECAY TIME, BREAK POINT, SUSTAIN LEVEL, RELEASE TIME, RELEASE LEVEL, VDA EG TIME VEL SENSE SWAPOLARITY, ATTACK, SLOPE, RELEASE, VDF EG TIME VEL SENSE SWAPOLARITY, ATTACK, SLOPE, RELEASE, VDA EG TIME VEL SENSE SWAPOLARITY, ATTACK, SLOPE, RELEASE.

COMBINATION PARAMETERS

Table with 5 columns: No., PARAMETER, M3R, REL, OFFSET. Rows include COMBINATION TYPE, SINGLE TYPE, PROGRAM No., LEVEL, PANPOT, LAYER TYPE, PROGRAM No., LEVEL, PANPOT, DAMPER FILTER, PROGRAM No., LEVEL, PANPOT, DAMPER FILTER, INTERVAL, DETUNE, SPLIT TYPE, LOWER PROGRAM No., LEVEL, PANPOT, DAMPER FILTER, UPPER PROGRAM No., LEVEL, PANPOT, DAMPER FILTER, SPLIT POINT, VELOCITY SWITCH TYPE, SOFT PROGRAM No., LEVEL, PANPOT, DAMPER FILTER, LOUD PROGRAM No., LEVEL, PANPOT, DAMPER FILTER, VEL SW POINT, MULTI TYPE, PROGRAM No., LEVEL, KEY RESPONSE, DETUNE, PANPOT, KEY WINDOW TOP, KEY WINDOW BTM, VEL WINDOW TOP, VEL WINDOW BTM, PROG CHG FLT, A-TOUCH FLT, CENTRE CHG FLT, DAMPER FILTER, MIDI CHANNEL.

EFFECT PARAMETERS

Table with 5 columns: No., PARAMETER, M3R, REL, OFFSET. Rows include EFFECT 1, EFFECT TYPE SELECT, OFF/ON, Parameter A, Parameter B, Parameter C, Parameter D, Parameter E, Parameter F, Parameter G, Parameter H, EFFECT 2, EFFECT TYPE SELECT, OFF/ON, Parameter A, Parameter B, Parameter C, Parameter D, Parameter E, Parameter F, Parameter G, Parameter H, PLACEMENT, PLACEMENT, OUT 3 PANPOT, OUT 4 PANPOT.

DRUMS PARAMETERS

Table with 5 columns: No., PARAMETER, M3R, REL, OFFSET. Rows include DRUM KIT 1, INSTRUMENT, KEY, TUNE, LEVEL, DECAY, PANPOT, DRUM KIT 2, DRUM KIT 3, DRUM KIT 4, Same as DRUM KIT 1, Same as DRUM KIT 1.

Parameters A~H correspond to position A~H of the RE1 See P. 79

## SYSTEM EXCLUSIVE MESSAGE APPLICATIONS

MIDI Exclusive messages can be used in the following ways.

1. Transmit or receive data for All Combi, All Prog, Effect, Drums, or Global (partial) ... Use the MIDI data dump page of Global mode.
2. Transmit, receive, and edit data for 1 Combi, 1 Prog, Effect, and Drums. Use two M3R units both set to Exclusive ENA.
3. Adjust master tuning or determine the model number. Use a personal computer with editing software, and set the M3R to Exclusive ENA.
4. Receive data or Data Dump Requests for the above 1, 2, 3; confirm M3R status, etc. Use a personal computer with M3R editing software, and set the M3R to Exclusive ENA.

\* The MIDI Global channel is used when transferring MIDI Exclusive data.

(The transmitting unit is called the "master", and the receiving unit is called the "slave".)

1. The various types of internal data can be transmitted in the Global mode. MIDI data dump page (see page ??). When another M3R receives this data (the receiving M3R must be set to the same MIDI channel, with Protect Off and Exclusive ENA, or it must be in the MIDI data dump page), its previous internal data will be replaced by the newly received data.
2. When both the master and the slave are set to Exclusive ENA, you can edit the slave unit (Combi, Prog, Effect, Drums) using switch operations on the master unit (except for Rename and Write). In this situation, each time you select another Combi or Prog number on the master unit, data for 1 Combi or 1 Prog will be transmitted from the master to the slave, allowing you to copy individual Combinations or Programs. (Unless you write this newly received data, it will be overwritten by the next incoming data.)
3. When a Universal System Exclusive (an exclusive message which is not specific to any manufacturer) Device Inquiry Request message is received, the M3R will transmit the manufacturer ID (=42; Korg), the model ID (=24/M3R), and the ROM No. etc. When a RPC (Registered Parameter Controller) master tune message is received, the master tune setting will be edited.

### Note:

The MIDI specification says that master tuning will be done as follows.

(1) Bit 64, 0:1, Bit 65, 0:0 selects Master Tune (in MIDI channel)

(2) Bit 06, vv, Bit 26, vv determines the value (14 bit)

MSB LSB  
(7 bit) (7 bit) 00 00 - 40 00 - 7F, 7F  
-100 - -00 - +99.9 (cents)

However, the M3R will

(1) enter the master tune page of Global mode when the data is received.

(2) and modify the value in steps of 1 cent. However since the M3R tuning range is ±50 cents, only values of the range 20.00 to 60.00 will be effective, and values outside this range will be treated as either -50 or +50 cents.

4. By connecting the M3R to a personal computer with M3R editing software, you can perform the operations described above in 1, 2, 3; receive a Write, Request and write data; check the contents (names only) of a PCM card; and the condition of the unit (the mode, and the type of card that is inserted).

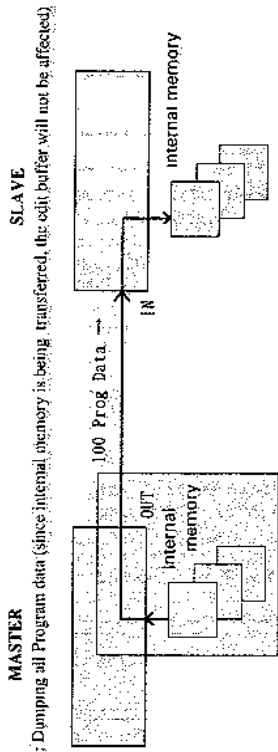

1. Example: Dumping all Program data (since internal memory is being transferred, the edit buffer will not be affected)

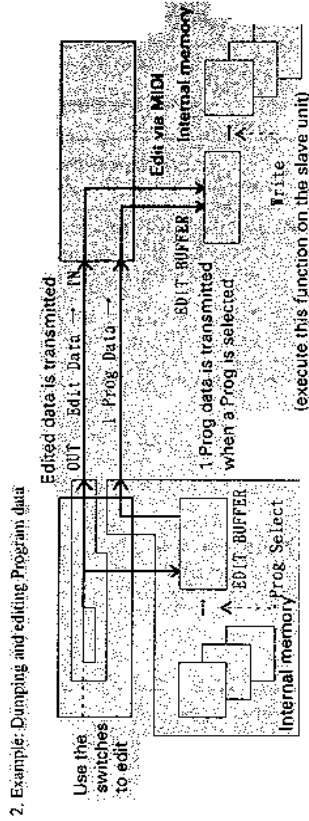

2. Example: Dumping and editing Program data

3. Universal system exclusive Device Inquiry

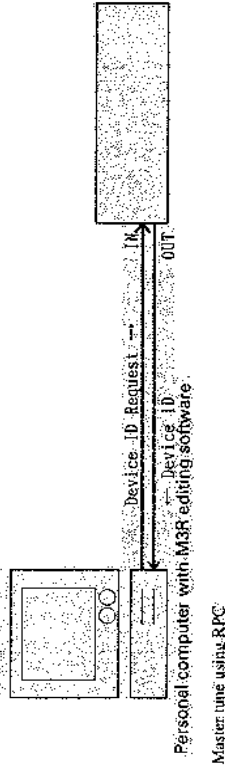

Personal computer with M3R editing software  
Master tune using RPC

The master tune display of Global mode will be selected, and the data will be modified.

4. Example: Request All data dump

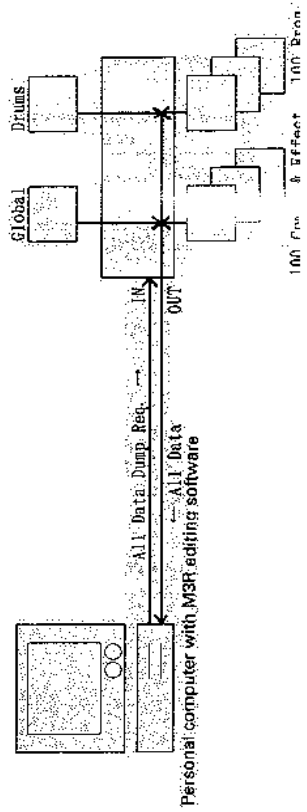

Personal computer with M3R editing software

## ERROR MESSAGES

Error message	Explanation
Battery Low	The voltage of the internal memory backup battery is low. (Contact your nearby service representative or dealer.)
CARD Battery Low	The voltage of the card backup battery is low. (Temporarily save the card data into internal memory, replace the card battery, and save the data from internal memory back into the card. When you remove the card battery, all card data will be lost.)
Invalid CARD	The inserted card does not contain data or is not formatted for the M3R. (To use this card, you must execute GLOBAL mode [5C] Format Cartridge.)
Memory Protected	The memory into which you attempted to write (internal or card) is protected by the GLOBAL mode protect setting.
No CARD Inserted	You tried to read or write card data when no card was inserted.
ROM/Protected	You tried to write data into a ROM card or into a RAM card whose protect switch was ON.
Unformatted CARD	The inserted card has not been formatted (initialized) for use with the M3R. (To use this card, execute GLOBAL mode [5C] Format Card.

## SPECIFICATIONS AND OPTIONS

System	: AI synthesis system (full digital processing)
Tone generator	: 16 voice, 16 oscillator
Wave memory	: PCM 16 Mbit
Effect section	: 2 systems of digital multi-effects
Number of program	: 100 programs
Number of combinations	: 100 combinations
Demo	: 5 songs
Outputs	: 1/L, 2/R, 3, 4, headphones
Card slot	: PCM data, programs
MIDI	: IN, OUT, THRU REMOTE jack
Display	: 16 character x 2 line backlit LCD
Options	: RAM card (MCR-03), ROM cards, PCM cards
Power supply	: 100 V
Power consumption	: 11 W nominal
External dimensions	: 430 (W) x 405 (D) x 88 (H) mm
Weight	: 5.9 Kg (not including rack-mount adapter)

\* Specifications and appearance are subject to change without notice for product improvement.



# TROUBLESHOOTING

Problem	Possible reason
No LCD display even though the POWER switch is on	<ul style="list-style-type: none"> <li>• Is the power cable connected to an AC outlet?</li> </ul>
No sound	<ul style="list-style-type: none"> <li>• Is an amp or headphone connected to the correct socket?</li> <li>• Is the master volume raised?</li> <li>• Are any of the level parameters in each mode set to 0?</li> <li>• Are you playing a key which the split or pitch range produces no sound?</li> <li>• Are MIDI connections between the keyboard and the M3R correct?</li> <li>• Do the MIDI channels of the keyboard and the M3R match?</li> </ul>
Cannot format a card	<ul style="list-style-type: none"> <li>• Is the card protect switch set to ON?</li> </ul>
Cannot save data to card	<ul style="list-style-type: none"> <li>• Are you using an unformatted card?</li> <li>• Is the card protect switch set to ON?</li> <li>• Are you using a ROM card?</li> <li>• Is the card correctly inserted?</li> </ul>
Cannot load data from card	<ul style="list-style-type: none"> <li>• Is the card correctly inserted?</li> <li>• Does the card contain data?</li> </ul>
The sound is wrong	<ul style="list-style-type: none"> <li>• Is the same PCM card inserted as when you created the sound?</li> <li>• Is the same PROG data card inserted as when you created the combination data?</li> </ul>

### M3R MIDI IMPLEMENTATION CHART

Function . . .		Transmitted	Recognized	Remarks
Basic Channel	Default Change	1 ~ 16 1 ~ 16	1 ~ 16 1 ~ 16	Memorized
Mode	Default Messages Altered	× *****	3 ×	
Note number:	Sound range	0 ~ 127 *****	0 ~ 127 0 ~ 127	*4
Velocity	Note on Note off	○ 9n, V=1 ~ 127 ×	○ 9n, V=1 ~ 127 ×	
After Touch	Keys Ch's	× ○	× ○	Transmit/receive when AFTER TOUCH is set to ENA in GLOBAL mode *4
Pitch bend		○	○	*1, 4
Control Change	1 2 6 7 38 64 80 96 97 100 101 0-101	× × × × × × × ○ ○ × × ○	○ ○ ○ ○ ○ ○ ○ ○ ○ ○ ○ ○	Pitch MG *1 VDF modulation *1 Data entry (MSB) *5 Volume *1 Data entry (LSB) *5 Damper pedal *1 Rotary speaker speed *1 Data increment *2 Data decrement *2 LSB of RPC for master tune *6 MSB of RPC for master tune *6 *4
Program Change	Actual No.	○ 0 ~ 99 *****	○ 0 ~ 127 0 ~ 99	Transmit/receive when PROG/ COMBI CHANGE is set to ENA in GLOBAL Mode.
System Exclusive		○	○	*2, 3
System	: Song pos. Common : Song sel. : Tune	× × ×	× × ×	
System	: Clock Real time : Commands	× ×	× ×	
Aux Message	: Local ON/OFF : All note off : Active sensig : Reset	× × ○ ×	× ○ 123 ~ 127 ○ ×	
<p>NOTES: *1 Transmit/receive if CONTROL is set to ENA in GLOBAL Mode.            *2 Transmit/receive if EXCLUSIVE is set to ENA in GLOBAL Mode.            *3 Dumps and edits the Program data. Compatible with universal exclusive (Device ID).            *4 Transmit when OVERFLOW is set to ON in GLOBAL mode.            *5 Receive when EXCLUSIVE is set to ENA in GLOBAL mode. Transmit/receive when RE1 is connected.            *6 Receive when EXCLUSIVE is set to ENA in GLOBAL mode.</p>				

Mode 1: OMNI ON, POLY  
Mode 3: OMNI OFF, POLY

Mode 2: OMNI ON, MONO  
Mode 4: OMNI OFF, MONO

○ : Yes  
× : No

## MULTISOUND LIST

0 0	Piano	2 3	Digi. Bell2	4 6	Hard Sax	6 9	Wire 2
0 1	E. Piano 1	2 4	Tubular	4 7	Mute Tp	7 0	S&H Wave
0 2	Soft E. P.	2 5	Bell Ring	4 8	Tromb&Tp	7 1	Digital 1
0 3	Hard E. P.	2 6	Vibe	4 9	Clarinet	7 2	Digital 2
0 4	Clav	2 7	Kalimba	5 0	Koto Trem	7 3	Digital 3
0 5	Harpsicord	2 8	Marimba	5 1	Lore	7 4	Digital 6
0 6	Perc. Organ	2 9	Music Box	5 2	Wind Bells	7 5	Digital 7
0 7	MagicOrgan	3 0	Gamelan	5 3	Pole	7 6	Sine
0 8	Guitar 1	3 1	Clicker	5 4	Pluck	7 7	SquareWave
0 9	Guitar 2	3 2	SynMallet	5 5	Hammer	7 8	Saw Wave
1 0	ElecGuitar	3 3	Flute	5 6	Metal Hit	7 9	10% Pulse
1 1	JazzGuitar	3 4	Pan Flute	5 7	Pop	8 0	20% Pulse
1 2	MuteGuitar	3 5	Bottles	5 8	Vibe Hit	8 1	DWGS Clav
1 3	Harmonics	3 6	Voices	5 9	Block	8 2	DWGSOrgan1
1 4	Sitar	3 7	Choir	6 0	Spectrum 1	8 3	DWGSOrgan2
1 5	A. Bass	3 8	Strings	6 1	Spectrum 2	8 4	DWGS E. P. 1
1 6	Slap Bass	3 9	Analog	6 2	Spectrum 3	8 5	DWGS Voice
1 7	Round Bass	4 0	SoloString	6 3	Spectrum 4	8 6	DWGS Vibe
1 8	Fletless	4 1	TubaFlugel	6 4	Voice Wave	8 7	DWGS Bell1
1 9	Pick Bass	4 2	DoubleReed	6 5	Fv Wave	8 8	DWGS Bass1
2 0	SynthBass1	4 3	Brass 1	6 6	Perc. Wave	8 9	DWGS Bass2
2 1	SynthBass2	4 4	Brass 2	6 7	Ep Wave		
2 2	Digi. Bell1	4 5	Tenor Sax	6 8	Wire 1		

## DRUM SOUND LIST

0 1	Kick 1	1 3	Crash	2 5	Bell Ring	3 7	Wind Bells
0 2	Kick 2	1 4	Conga 1	2 6	Kalimba	3 8	Pole
0 3	Kick 3	1 5	Conga 2	2 7	Gamelan 1	3 9	Pluck
0 4	Snare 1	1 6	Timbales	2 8	Gamelan 2	4 0	Hammer
0 5	Snare 2	1 7	Cowbell	2 9	Clicker 1	4 1	Metal Hit
0 6	Snare 3	1 8	Claps	3 0	Clicker 2	4 2	Spectrum3L
0 7	Side Stick	1 9	Tambourine	3 1	Vibe Hit	4 3	Spectrum3H
0 8	Tom	2 0	E. Tom	3 2	Block	4 4	Spectrum4L
0 9	Closed HH1	2 1	Ride	3 3	Perc. WaveL	4 5	Spectrum4H
1 0	Open HH1	2 2	Rap	3 4	Perc. WaveH		
1 1	Closed HH2	2 3	Whip	3 5	Lore 1		
1 2	Open HH2	2 4	Tubular	3 6	Lore 2		

### NOTICE

KORG products are manufactured under strict specifications and voltages required by each country. These products are warranted by the KORG distributor only in each country. Any KORG product not sold with a warranty card or carrying a serial number disqualifies the product sold from the manufacturer's/distributor's warranty and liability. This requirement is for your own protection and safety.

**KORG**<sup>®</sup> KORG INC.  
15-12, Shimotakaido 1-chome, Suginami-ku, Tokyo, Japan.