

MUSIC WORKSTATION

01/W_{FD}·01/W

Quick Guide

KORG [®] ②

I : Setting Up..... 3

Connecting the 01WFD •01/W to External Devices 3

①Connecting with a stereo audio amplifier..... 3

②Connecting with a keyboard amplifier..... 3

BASIC OPERATION 3

① Selecting a Combination 5

② Selecting a Program 5

Sound Making Process..... 6

①A program, which is the basic sound block
in the 01/WFD•01/W, consists of a number
of parameters which control the sound 6

②Two or more programs can be combined to
make up a Combination 7

II : Creating a program (EDIT PROGRAM) 8

Selecting “EDIT PROGRAM”..... 8

PAGE 0:OSC(Oscillator)..... 9

PAGE 1:Emphasis, Wave Shape..... 10

PAGE 2:VDF1(PAGE 3:VDF 2) 11

PAGE 4:VDA1(PAGE 5:VDA2)..... 11

PAGE 6:Pitch Modulation 13

PAGE 7:VDF/VDA Modulation..... 14

PAGE 8:EFFECTS..... 14

① Important relationship between Inputs and Outputs 14

② Effect Selection in EDIT PROGRAM is disabled 15

III : EDIT COMBINATION 16

① Playing a single sound in Combination 16

② Playing two or more sounds in Combination..... 17

① Building a Multi Combination with several Timbres..... 19

② Building a Single sound with several Timbres 20

IV : Using the Effects..... 21

TYPES AND OPERATION OF EFFECTS..... 22

(1)Reverb Group 22

①The most frequently used Reverb effects:Hall,
Room and Wet Plate 22

②Simulating live performance at live stage or
concert hall..... 22

(2)Early Reflection Group 23

①Using Early Reflection for reinforcing low
frequency range 23

② Creating a cymbal sound with a reverse effect 24

(3)Delay Group..... 24

① Panning Delay Sound with Cross Delay	24
② Using Stereo Delay for Strings sounds	25
(4) Chorus, Flanger, Phaser Group	25
① Using Chorus effect for guitar	26
② Using Harmonic Chorus for bass	26
③ Adding motion to Strings with the Flanger	26
④ Phaser is best suited for rhythm cutting on guitar	26
(5) Other Effects	27
① Using Tremolo for electric piano	27
② Making a careful decision to use Enhancer	27
③ Trying Rotary Speaker on other instruments	27
Using Effects in Multi Play	27
① Effect Setting for Rhythm Section	28
② Making a careful decision to use Reverb	28

V : Creating Sounds

Combining two programs	29
Be Creative with Multisounds	30

VI : Recording with a Sequencer

① Choosing a Recording Mode	36
② Determining a Quantizing Resolution	36
③ Selecting Programs for each Track	37
④ Selecting Panpot and Volume for each Track	37

Recording a Rhythm and Melody

① Selecting Song Tracks and Programs	37
② Checking Programs on Each Track	38
③ Recording a Drum Part with Patterns	38
④ Recording a Bass Part by Real Time Recording	38
⑤ Setting Monitor Tracks ON/OFF	39
⑥ Correcting track data by Auto Punch IN/OUT	39

A sample MIDI system around 01WFD •01/W

① Making full use of each instrument's features	41
② Use of sequencer	41
③ Wave sequence on the Wavestation	42
④ Setting	42

I : Setting Up

Connecting the 01/WFD-01/W to External Devices

Make sure that all cables are securely connected to the input terminals of external devices.

① Connecting with a stereo audio amplifier

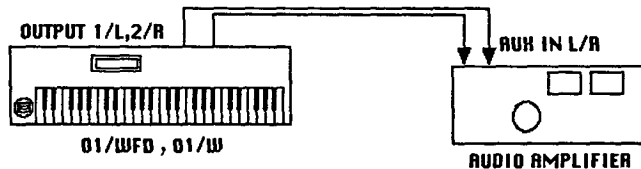

② Connecting with a keyboard amplifier

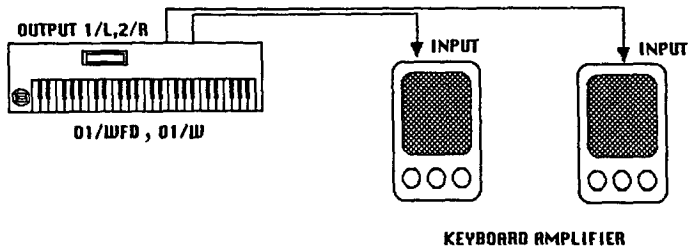

NOTE

Connecting with a keyboard mixer can most effectively utilize the output functions of the 01/WFD-01/W.

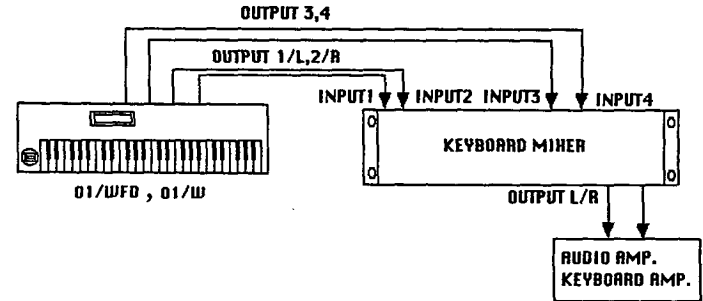

BASIC OPERATION

The mode keys on the front panel provide access to various operation modes of the 01/WFD-01/W. To change modes, simply press the corresponding key.

The sound making process on the 01/WFD-01/W is primarily done in the program mode and the combination mode. These modes are related to each other as in the diagram below.

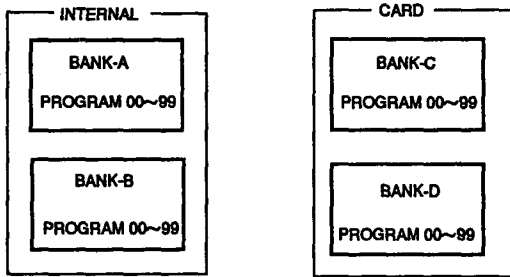

PROGRAM..... Up to 100 programs can be stored into each of 2 Internal Banks and 2 Card banks.

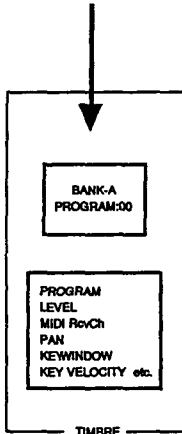

Timbre can be made by setting parameters (Level, MIDI Rcv ch, and so on) of any program.

A combination can be made by up to 8 different timbres.

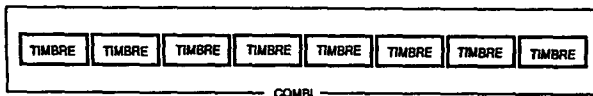

Each individual sound is selected and played as a Program, two or more Programs are combined into a Combination.

For example, strings and brass sounds can be layered as a combination. Up to 8 programs can be assigned in Combination and independently controlled to provide a multi - timbral sound source for use with an external sequencer.

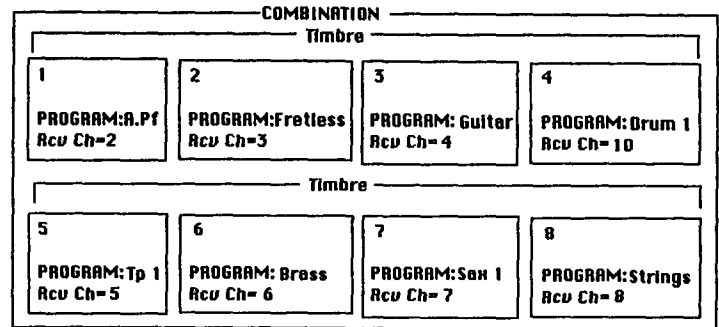

① Selecting a Combination

Press the COMBI key to enter the Combination mode.

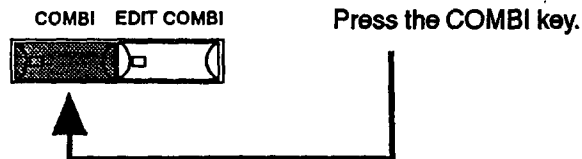

Press the BANK key to select the bank number of the desired combination.

(For 01/W , press the INT/CARD Key and the BANK key.)

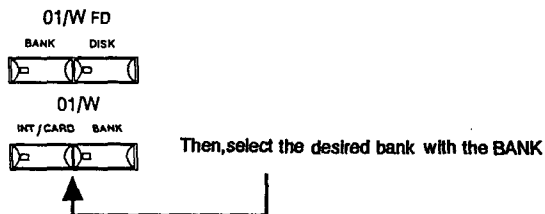

Press the Number key to select the desired combination number.

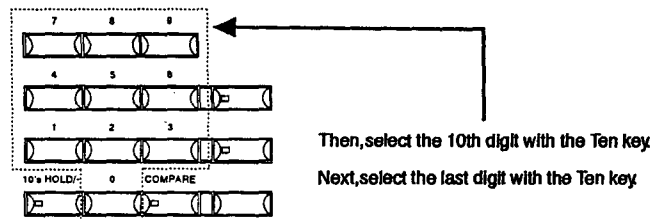

② Selecting a Program

Press the PROG key first.

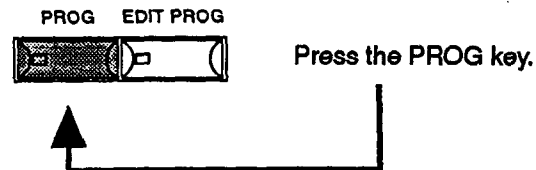

Press the **BANK** key to select the bank number (0 – 9) of the desired program.

(For 01/W , press the INT/CARD Key and the BANK key .)

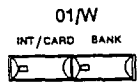
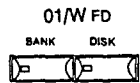

Then, select the desired bank with the **BANK** key.

Press the **Number** key to select the desired program number.

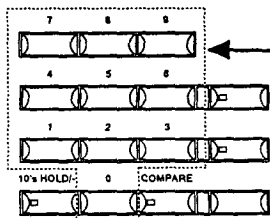

Then, select the 10th digit with the **Ten** key.
Next, select the last digit with the **Ten** key.

Sound Making Process

Here is a summary of the 01/WFD·01/W's sound making process.

- ① A program, which is the basic sound block in the 01/WFD·01/W, consists of a number of parameters which control the sound.

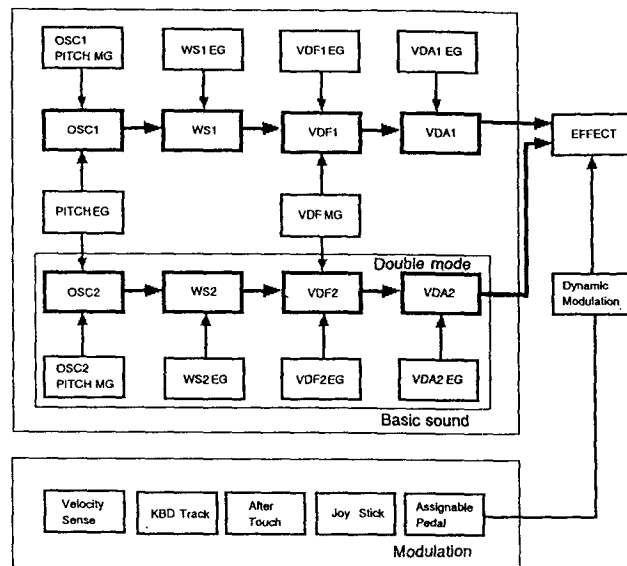

②Two or more programs can be combined to make up a Combination

Separate MIDI channel, keyboard range and velocity range can be assigned to each of up to 8 programs and controlled independently.

Programs are assigned to Timbres 1 – 8 in this setting.

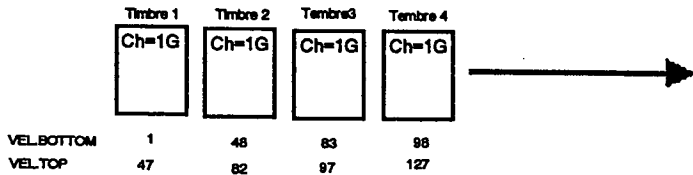

In the above combination, MIDI channels of timbres 1 through 4 are assigned to the Global setting so that these timbres can be actually played by the keyboard and further controlled by the touch depending on the setting of the top and bottom.

Making full use of Multi playing

The advantage of multi – timbral instrumentation is that each program can be assigned to an individual Timbre, for independent control. This setting is especially useful for use with an external sequencer. Furthermore, assigning 2 (or more) timbres' MIDI channel to that of the Global MIDI channel allows you to play these programs simultaneously (same as the Layer combination). This function can be used to play thick layered sounds. Since the 01/WFD•01/W is 32 voice polyphonic, a layer with 2 programs provides 16 polyphonic voices, a layer with 4 programs provides 8 polyphonic voices, etc.

II : Creating a program (EDIT PROGRAM)

The basic sound block in the 01/WFD•01/W is a Program. Therefore, creating a new sound means that you are actually building a new Program.

As in the following diagram, the 01/WFD•01/W is equipped with internal waveforms which are called Multisounds. The multisounds are a collection of acoustic sounds and synth sounds that are sampled for each sound range and assigned to the keyboard.

These Multisounds serve as the starting point for creating a new program, "EDIT PROGRAM". Thus, the "EDIT PROGRAM" starts with selecting the most suitable waveform from the Multisounds.

Unlike the previous M and T series, the 01/WFD•01/W is capable of editing components of each waveform so that any waveform can be changed in envelope or reshaped in a number of ways.

Selecting "EDIT PROGRAM"

Press the EDIT PROG key to select the Edit Program mode. Each Program has its editing parameters in several display pages. The PAGE +/- keys allow you to access succeeding and preceding pages, respectively.

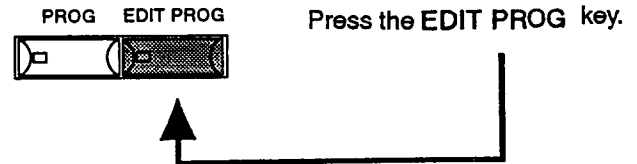

PAGE 0:OSC(Oscillator)

The 01/WP•01/W contains 2 oscillators; OSC 1 and OSC2. This page controls the setting of each oscillator depending on the current Oscillator mode. In SINGLE, one OSC1 → Emphasis1 → Wave Shaping1 → VDF1 → VDA1 system is used. In Double, a second system (OSC2 → Emphasis2 → Wave Shaping2 → VDF2 → VDA2) is added to allow greater in sound making.

This page contains the following parameters to be edited.

- Oscillator Mode

SINGLE or DOUBLE

- Number of Voices and Hold.

The number of voices varies according to the Oscillator mode.

The 01/WP•01/W is a 32 polyphonic Music Workstation. When POLY is assigned, the maximum number of voices available is 32 in SINGLE Oscillator mode, but decreased to 16 in Double mode. When MONO is assigned, only a monophonic voice is available. POLY is recommended for chord oriented sounds such as Piano or Strings while MONO best fits single note playing for sounds such as Bass and Synth Lead.

When the Hold parameter is set to ON, notes played will continue to sound even after releasing the key. This parameter is mainly used for obtaining natural sustain out of transient sounds such as the Drum Kit. This is not always desirable on continuous sounds such as Organ or Strings.

•Selection and Volume of Oscillator 1 and 2

When DOUBLE is selected, OSC1 and OSC2 have Independent levels.

•Pitch Adjustment of Oscillator 1 and 2

Slightly detuning the pitch of two oscillators will create an ensemble effect between the oscillators or build effective timbres such as honky – tonk piano.

•Selection of Envelope to Pitch

Natural brass sounds tend to have unstable pitch at the initial attack. This unique character of instruments can be simulated by adjusting the Pitch with Envelope.

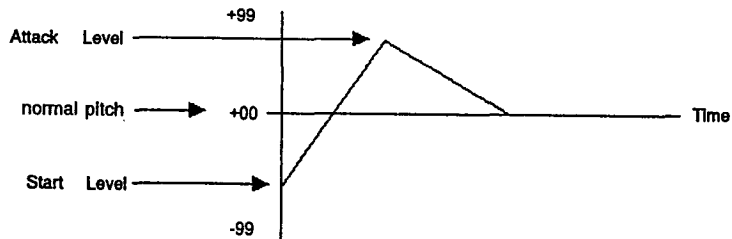

PAGE1:Emphasis, Wave Shape

This page controls the processing of waveform, which is the O1/WFD•O1/W's own unique function.

The Emphasis increases the clarity of the sound by giving greater definition. The degree of the Emphasis can be velocity controlled so that delicate color changes such as those of acoustic piano can be easily expressed by touch.

The Wave Shape transforms the waveform and generates new harmonic overtones that are not included in the original waveform. This function can be used for simulating the resonant filter sweep effect of analog synthesizers or adding a distortion effect to the basic sound. For more details, refer to waveforms 0 – 59 in the Wave Shape Table.

PAGE2:VDF1 (PAGE 3:VDF 2)

This page controls the tonal quality of the sound by cutting off the high frequency components of the waveform.

Cutoff controls how bright or soft the sound will be. This page also determines the degree to which the EG and velocity will affect the cutoff frequency.

Keyboard Tracking is normally used for adjusting the sound color uniformly over the keyboard. This is effective for all keyboard ranges as well as specific high and low ranges.

[About VDF EG]

The 01/WF0-01/W is equipped with an EG for each VDF and the VDA. In the VDF EG, the speed of each parameter (Attack Time/ Decay Time/ Slope Time/ Release Time) can be changed by velocity or the keyboard position.

This feature is especially useful for simulating delicate articulation of playing acoustic instruments. This freedom of touch control over the sound color widely expands the area of artistic expression.

PAGE4:VDA1 (PAGE5:VDA2)

This page controls the volume of the basic waveform sound.

The VDA mainly includes the velocity, EG and Keyboard Tracking. Among others, the VDA EG is especially important for constructing a distinctive character of each sound.

★Using VDA EG and VDF EG properly★

Any sound has the universal tendency to change in tone as the volume changes. You can find out that tone becomes softer as the sound decays by closely listening to any instrument such as piano or guitar.

This character of acoustic sound can be simulated with the VDA in volume change and with the VDF in tone change. The EG INTENSITY parameter in the VDF determines the range for the tone to change over time.

These volume and tone changes over time usually play major roles in sound making. Making a good or bad sound depends on how carefully you program this EG parameter.

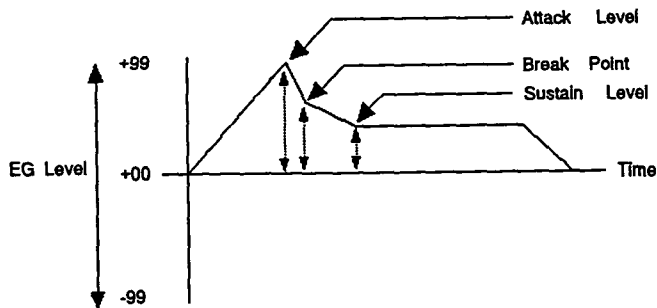

[Typical EG Set - up]

Piano

To simulate the decaying sound of piano, set the Sustain level at 0 and create the decay with Slope time. You may set the Break point at 80 and make up an attack feel with Decay time.

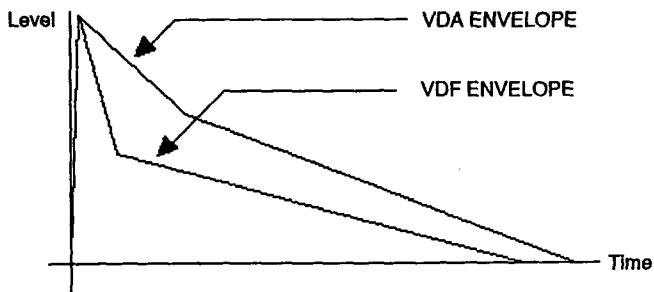

Organ

The organ sound is characterized by a click noise at the initial attack and quick response to releasing the key. Set the Break point as the Sustain level and create a click in Sustain time.

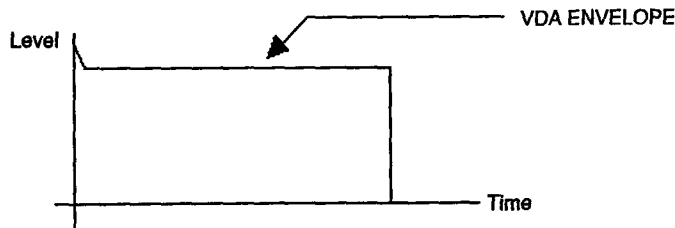

Strings

The basic Strings sound can be simulated by slowing down the Attack time for the bowing effect and adding the Release time for trailing notes. An actual string instrument sounds different with subtle differences in touch. Try to create a variety of string sounds with different touch, and play them in Combination mode.

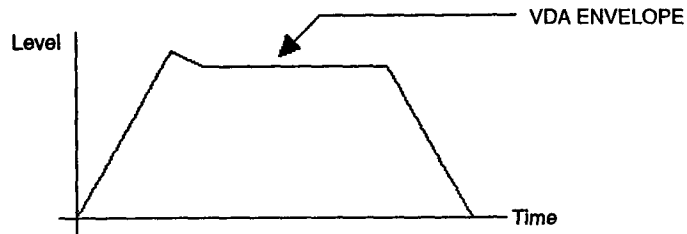

Brass

The key to a good brass sound is how well the VDF is combined with the EG, because real brass instruments sound different depending on playing technique or the player's mood. Construct the outline envelope with the VDA first. Then create the actual tonal quality with the VDF EG.

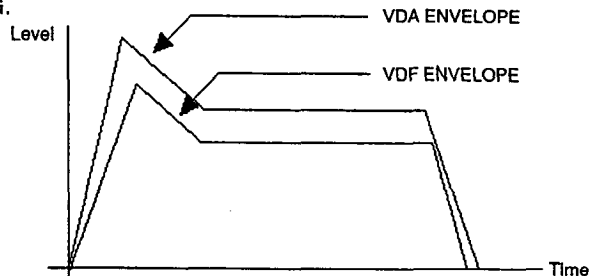

Guitar and Bass

Guitar and Bass have decaying sounds similar to that of the piano. Construct the outline envelope with the VDA first. Then set the VDF EG such that the tone becomes softer as the sound decays.

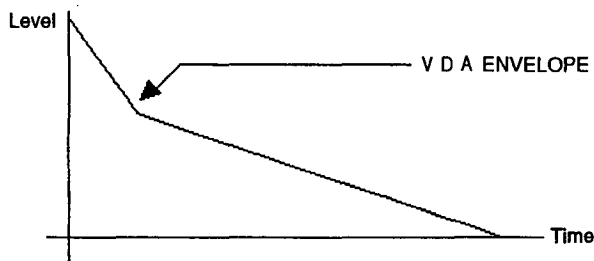

PAGE6:Pitch Modulation

This page is for modulating the pitch. The modulation set here is mainly the vibrato controlled by the MG, but the pitch can be also modulated by joystick or aftertouch.

In DOUBLE, MG1 and MG2 can be used separately. In SINGLE, only MG1 can be used.

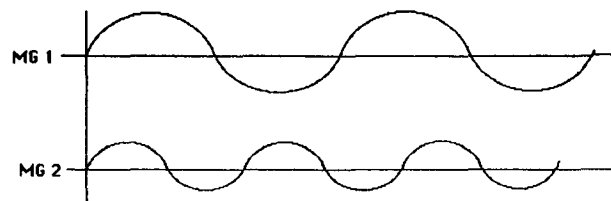

[Separate use of MG in Double Oscillator Mode]

The 01/WP*01/W contains 2 independent MG systems that are available for each of the 2 oscillators in DOUBLE mode. If the MG's are used as in the Fig.2 - 9, a slight difference in pitch can create an ensemble space. This will sound even wider when used with a Chorus Effect.

PAGE7:VDF/VDA Modulation

This page determines the degree to which the joystick, aftertouch and MG modulates the VDF and the VDA.

— How Aftertouch works —

Aftertouch is an effect that can be used to control the depth of modulation or other parameters by pressing down hard after playing the keys. Since any of the available controllers can be assigned to a modulation source, different modulations can be arranged to be played simultaneously during playing. For example, assigning aftertouch to vibrato and joystick to pitch bend will allow you to play both modulations at the same time. Assigning aftertouch to pitch bend may be sometimes effective for expressing certain instruments such as Koto. Aftertouch is often assigned to control the cutoff frequency so that the brightness of a sound can be controlled by pressing down hard on the keys.

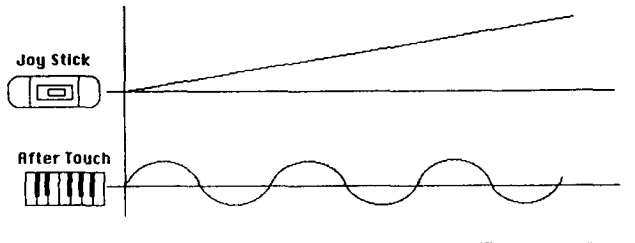

PAGE8:EFFECTS

The 01/WFD-01/W includes a self – contained Multi Effects unit that consists of two independent and identical effect processors. These processors can be arranged in three configurations: one serial configuration and two parallel configurations.

① Important relationship between Inputs and Outputs

Before selecting an effect configuration, choose the Inputs you wish to use. (Inputs at A and B go through FX 1, Inputs at C and D go through FX 2.) In Serial routing, Inputs at A and B go through FX 1 and FX2 but Inputs at C and D only go through FX2.

② **Effect Selection in EDIT PROGRAM is disabled**

When 2 sounds are made with 2 effects each in EDIT PROGRAM (for example, a guitar sound with Distortion and Chorus, and a strings sound with Flanger and Reverb), an attempt to combine these sounds into a Combination will require 4 effects while the 01/WP•01/W contains only 2 effect processors. In this case, the 01/WP•01/W ignores the effect selection made in EDIT PROGRAM and instead uses the effect selection in Combination.

The best way to avoid this inconvenience is to program a sound in two modes during EDIT PROGRAM: Prepare a SINGLE sound with all parameters including effects. Prepare a MULTI sound without assigning any effects.

III : EDIT COMBINATION

A combination can consist of up to 8 Timbres. Each Timbre is like a box where a Program is assigned with its MIDI channel, Volume, Pan and other parameters. With 8 Timbres altogether, the 01/WP-01/W can be played as if there were 8 different synthesizers being played simultaneously.

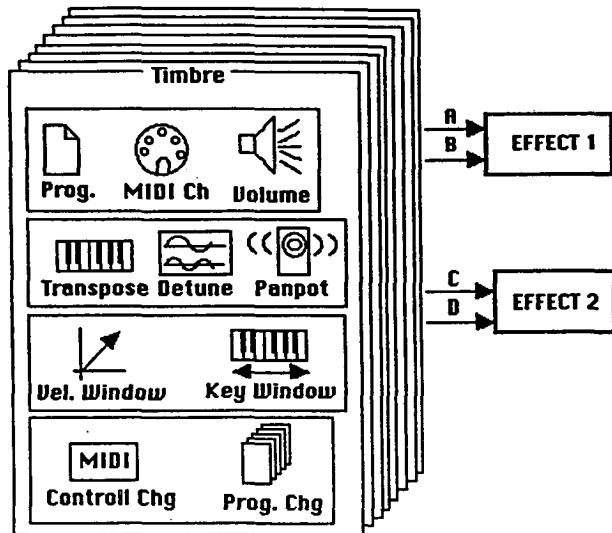

① Playing a single sound in Combination

Only one single Timbre is used. This is the same as directly using a single program made in EDIT PROGRAM. This setting is useful for featuring the acoustic character of one sound such as acoustic piano, guitar or wind instrument and expressing it without being mixed with other sounds.

Since only one particular Timbre can be played on the keyboard by matching its MIDI channel to the Global channel, this setting has the same function as the Program play.

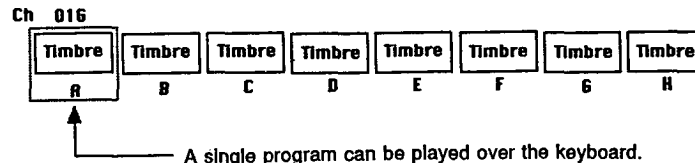

②Playing two or more sounds in Combination

One of the ways to utilize the 01/WFD-01/W's great capability is to play two or more sounds simultaneously in Combination.

[Building up a thick sound by layering Timbres : Layer]

This type of Combination is especially useful for building up a thick string or brass ensemble sound. It is also used to create a new sound with an unusual combination of two unmatching sounds such as Bell+Strings.

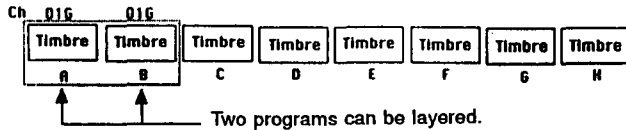

[Switching tone color with velocity : Velocity Switch]

The tone color of an acoustic instrument changes with different touch on the instrument. The 01/WFD-01/W is designed to simulate this character of an acoustic instrument by controlling the degree of velocity in Combination. Velocity is used to control the VDF Cutoff in Program but this is not effective enough for controlling slap bass or other sounds that require drastic tone changes.

In this case, program a soft touch sound for the low velocity range and a hard touch sound for the high velocity range, and assign them to the same MIDI channel so that these two sounds can be switched by the degree of your playing touch. Follow the sample procedure below.

Assign a soft touch sound to Timbre 1, and a hard touch sound to Timbre 2. Set the Velocity Window Top for Timbre1 to 87, and the Velocity Window Bottom to 0. Set the Velocity Top for Timbre2 to 127, and the Velocity Window Bottom to 88.

This procedure can further apply to switching the tone color up to 8 different steps.

Velocity Window

TOP 87 127
BOTTOM 1 88

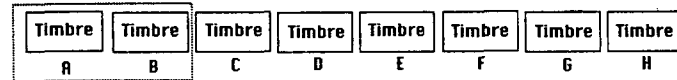

The sound switches between Timbre A and Timbre B at the Velocity value 87.

[Assigning different sounds for different sound ranges : SPLIT]

The 01/WFD•01/W's keyboard can be split into desired sound ranges to assign different sounds. For example, you can assign a bass sound to the low range and a piano sound for the middle and high ranges.

Assigning a drum set to the low range and a bass sound for the middle and high ranges will create a simple rhythm section over the keyboard. Assigning a trombone to the low range and a trumpet sound for the middle and high ranges will create a strong brass section over the keyboard. The major advantage of this SPLIT is that this uses up only one MIDI channel with one Combination.

Key Window
TOP C3 C5 67
BOTTOM C-1 C#3 C#5

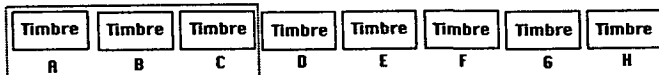

[Using the 01WFD•01W as a Multi Sound Source : Multi 1]

The 01/WFD•01/W can be used as multi sound source by assigning separate MIDI channels to 8 Timbres. If you have a MIDI sequencer, you can program the MIDI channels so that you can manually play the melody on the keyboard and have the sequencer accompany you.

To select the Timbre for your manual play, set its MIDI channel to the Global channel.

Prog.	R.Piano	E.Bass	E.Guitar	Strings	Brass	Flute	Harp	Drums
RecvCh	016	02	03	04	05	06	07	10
Volume	92	123	83	78	87	110	68	127
Panpot	5:5	5:5	7:3	5:5	5:5	6:4	3:7	5:5
	Timbre	Timbre	Timbre	Timbre	Timbre	Timbre	Timbre	Timbre
	A	B	C	D	E	F	G	H

[Using the 01WFD•01W as a Multi Sound Source : Multi 2]

Up to 8 Timbres can be separately played or mixed in any combination under your choice. For example, select a piano for Timbre 1, a bass for Timbre 2, a drum set for Timbre 3, and a strings ensemble for both Timbre 4 and 5. Assign Timbre 4 and 5 to the same MIDI channel. In this setting, each of Timbres 1 – 3 is routed on a separate MIDI channel thus independently controllable, but Timbres 4 and 5 sound together because they are assigned on the same MIDI channel.

This programming technique actually combines Multi and Layer modes. Adding Split, Velocity Control or other techniques will further expand the possibility of this Multi playing.

① **Building a Multi Combination with several Timbres**

For example, you can create an entire rhythm section with Velocity Switch piano (soft to hard) in Timbres 1 – 3, a Velocity Switch guitar (normal and distortion) in Timbres 4 – 5, a Velocity Switch bass (normal and slap) in Timbres 6 – 7, and a drum set in Timbre 8.

Timbre	MIDI Ch	Velocity	
		Window Top	Window Bottom
1:Soft Piano	2	64	1
2:Normal Piano	2	110	65
3:Hard Piano	2	127	111
4:Normal Gt.	3	87	1
5:Distortion Gt.	3	127	88
6:Normal Bass	4	92	1
7:Chopper Bass	4	127	93
8:Drum Set1	10	127	1

This combination builds up an ensemble of 4 instruments allowing fine nuance on each instrument.

Layer is added on to this setting in the example below.

Timbre	MIDI Ch	Velocity	
		Window Top	Window Bottom
1:Normal Piano	2	110	1
2:Hard Piano	2	127	111
3:Normal Gt.	3	87	1
4:Normal Bass	4	92	1
5:Chopper Bass	4	127	93
6:Strings1	5	127	1
7:Strings2	5	127	1
8:Drum Set1	10	127	1

The examples only illustrate the outlines of this operation. The actual sounds in this example may not be included in the 01/WFD•01/W.

In this example, string sounds are layered by assigning both sounds(Timbre 6 & 7) to the same MIDI channel (Channel 5) with the same Velocity value.

② Building a Single sound with several Timbres

This setting uses up several Timbres for making only one sound, but the more Timbres that are used up, the higher the quality of the sound will be.

This is especially useful for simulating the unique character of an acoustic instrument where the tone color changes in different sound ranges. For example, divide the 01/WP•01/W's keyboard into 8 separate sound ranges and assign Timbres with different Key Window values to each of the sound ranges. In other words, each of 8 Timbres is assigned to 8 consecutive sound ranges.

Stack sound used of Key Window function

Timbre A.....is a Organ sound used a slow frequency of MG.
Timbre B.....is a Organ sound used a little slow frequency of MG.
Timbre C.....is a Organ sound used a little fast frequency of MG.
Timbre D.....is a Organ sound used a fast frequency of MG.
Timbre E.....is a normal Organ sound unused MG.

	Timbre A	Timbre B	Timbre C	Timbre D	Timbre E	Timbre F	Timbre G	Timbre H
Top	B2	B3	B4	C6	C6			
Bottom	C1	C3	C4	C5	C1			

In this setting, Organ sounds used a different frequency of MG was stacked with a normal Organ sound (Timbre E) assigned on all register. By the way, a rotation of speaker goes fast as a upper register.

IV : Using the Effects

To get the best out of the built – in effect system, you need to fully understand the 3 types of effect placement and to be able to select the most suitable effect for the current Combination.

SERIAL

Effect 1 and Effect 2 are serially routed. Inputs A and B send signals to both Effect 1 and Effect 2 and become stereo outputs at 1/L and 2/R. Inputs at C and D only go through Effect 2 and directly out to outputs 3 and 4.

PARALLEL 1

Besides being able to use Effect 1 and Effect 2 as separate effect processors, this setting is capable of sending signals from Effect 2 to Outputs 1/L and 2/R as well as sending Inputs A and B to Outputs 1/L and 2/R and sending Inputs C and D to Outputs 3 and 4.

PARALLEL 2

In addition to sending parallel outputs as in PARALLEL 1, this setting is capable of sending signals from Effect 2 to Effect 1 and making mixed outputs at Outputs 1/L and 2/R. For example, a strings sound at Inputs A and B goes through a Reverb at Effect 1 only, but a guitar sound at Inputs C and D goes through a Chorus at Effect 2 and then goes through the Reverb at Effect 1. This operation can be done in SERIAL placement but the major difference between SERIAL and this PARALLEL 2 is that this setting is also capable of separately sending outputs from Effect 2 to Outputs 3 and 4.

TYPES AND OPERATION OF EFFECTS

(1) Reverb Group

Reverb group effects are used for adding ambience characteristics onto the sound, thus indispensable to any synthesizers. Built into the 01/WFD•01/W are a collection of effects that simulate various room sizes and reverb systems such as Hall, Room, Stage, Plate and Spring Reverb.

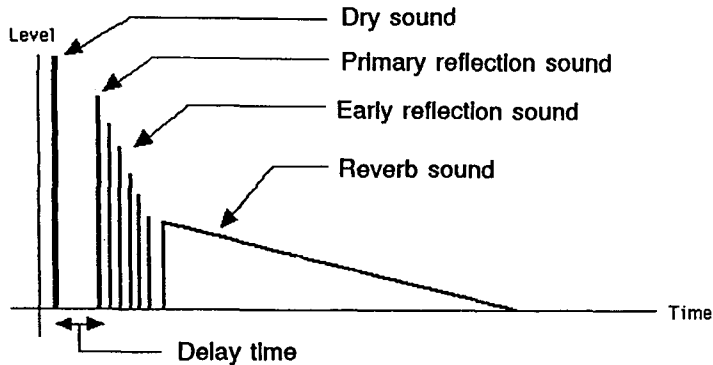

① The most frequently used Reverb effects : Hall, Room and Wet Plate

If you are not sure about choosing the right effect, use one of these 3 Reverb effects. Too much reverberation will cover up and ruin your sound. Make sure you set a proper balance between dry and wet sounds and try to use the least necessary Reverb time. Refer to the diagram below.



In the above diagram, Hall Reverb is used after Enhancer.

② Simulating live performance at live stage or concert hall

Allow longer reverb time for simulating larger rooms such as concert halls. Refer to the diagram below.

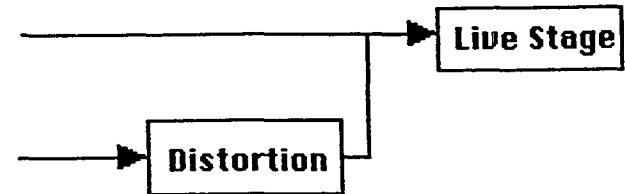

In the diagram, Distortion is used only for guitar, and Live Stage is used for all sounds.

[A Key to editing Reverb Group Effects]

Reverb effects work very differently by adjusting Reverb time and pre – delay parameters, and the way of editing parameters also differs in each type of Reverb effect. After adjusting these parameters the next step is to improve the Reverb sound with the equalizer. When the Reverb sound at high frequencies stands out, you may adjust the value of High Damp as well as changing the equalizer setting.

(2) Early Reflection Group

Early Reflection is an effect that allows you to adjust only the early reflections which are crucial in determining the realism of the Reverb sounds.

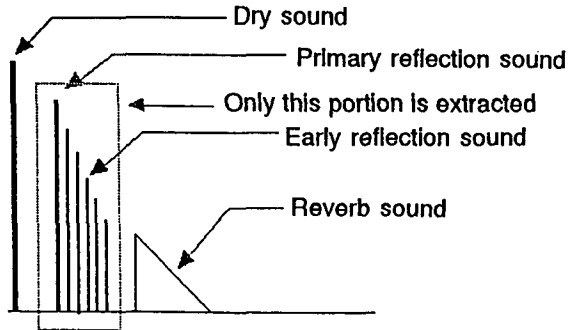

① Using Early Reflection for reinforcing low frequency range

Early Reflection can be used as a gating effect on drum sounds. The 01/WFD-01/W includes 3 types of Early Reflections that differ in the responding level to the early reflection time. Refer to the diagram below.

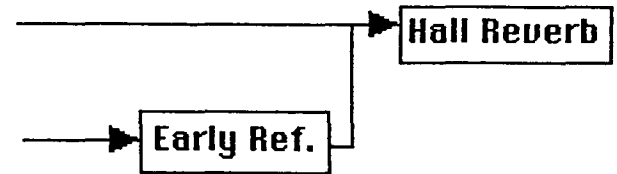

In the above diagram, Early Reflection is used for drum sound, and Hall Reverb is used for all sounds.

② Creating a cymbal sound with a reverse effect

Early Reflection III uses a reverse envelope on the early reflections. This effect creates an interesting reverse effect (similar to a tape recorder being played backwards) when applied to cymbals or other sounds that have strong attack characteristics. Refer to the diagram below.



[A Key to editing Early Reflection]

Early Reflection time and Pre - delay parameters are usually the major points of editing in Early Reflection, but try to improve the sound by adjusting the Equalizer setting also.

(3) Delay Group

Delay is another popular group of effects and it is almost as frequently used as Reverb group. A collection of both stereo and manual delay effects are built into the 01/WFD-01/W.

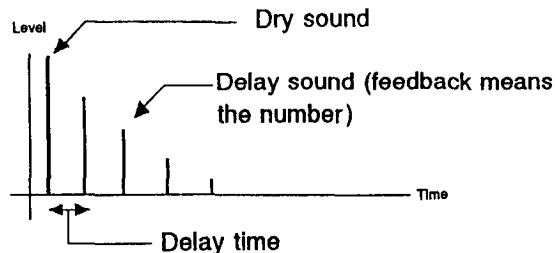

① Panning Delay Sound with Cross Delay

Since the feedback signal of each delay crosses over and is routed to the other delay, the delay sound repeats, panning across the stereo field. This creates exciting sound results when used for playing a solo or any other fast passages. Refer to the diagram below.



In the above diagram, Hall Reverb is used after Cross Delay to add proper reberveration.

② Using Stereo Delay for Strings sounds

For Strings or other sounds that require spacially spreading effects, Stereo Delay will not only open up the sound space but also enrich the tone color. Refer to the diagram below.



In the above diagram, Hall Reverb is used after Stereo Delay to add proper reverberation.

[A Key to editing Delay Group Effects]

Editing delay effects is not a very difficult operation. However, the Delay Time needs to be sometimes adjusted when the current delay setting sounds like it conflicts with the tempo of the tune. Remember, the length of a quarter note is 1 second when the tempo is set to 60. ($\text{♩} = 60$) When the tempo of a tune is set to 120 ($\text{♩} = 120$) for example, selecting the Delay Time at 500ms will produce each delay sound synchronized to the speed of the quarter note.

(4) Chorus, Flanger, Phaser Group

Chorus effects provide a warm ensemble sound by mixing the modulated effect sound with the dry sound. Flanger effects are achieved by the addition of feedback to the Chorus effect and are used for adding color and motion to the sound. Phaser effects use both time delay and phase shifting to create a more pronounced swirling and swishing sound than either Chorus or Flanger. All of these effects are essential to basic sound making on synthesizers.

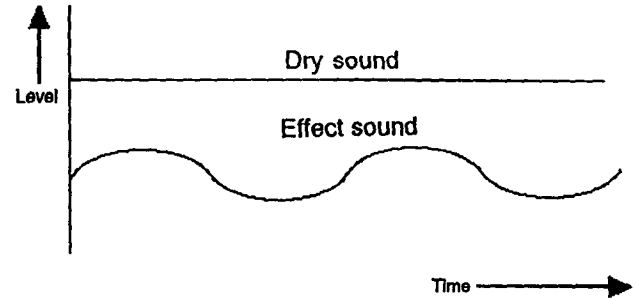

An ensemble effect can be created by mixing a modulated effect sound into the dry sound.

① Using Chorus effect for guitar

Using a Chorus effect has become a standard practice for almost all contemporary guitar players. Try a Chorus effect on the 01/WP-01/W's internal guitar sound. Refer to the diagram below.



In the above diagram, Chorus is used over an equalized sound.

② Using Harmonic Chorus for bass

Chorus effects have been frequently used by contemporary bass players but this Harmonic Chorus is also useful since it applies the chorus effect only to the high frequency range. With this Harmonic Chorus, you can affect the high range sound with a warm Chorus while leaving the heavy tone of the low frequency range as it is. Refer to the diagram below.



In the above diagram, Chorus is used over the sound thickened by Enhancer.

③ Adding motion to Strings with the Flanger

The Flanger effect provides swirling effect to the Strings sound. This sounds most effective when playing back – ground chords for soft tunes. Refer to the diagram below.



④ Phaser is best suited for rhythm cutting on guitar

When Phaser is used for rhythm cutting on guitar, the rhythm cutting notes on guitar pick up the phase shifted sound which blends into an extremely funky sound. Refer to the diagram below.



In the above diagram, Phaser is used after high range is emphasized by Equalizer.

(5) Other Effects

① Using Tremolo for electric piano

This setting is not as popular as it used to be, but Tremolo can be used on electric piano to come up with vibraphone – like sound effects.

② Making a careful decision to use Enhancer

Enhancer is a very useful effect for bringing drum, piano or other sounds to the forefront. However, you should not always rely on Enhancer especially for Multi play because using this effect will automatically limit the possibility of using other effects. (Remember, up to 8 Timbres can be used for Multi but only 2 common effects can be used for the entire system.) For example, other effects can be no longer available once Enhancer is selected on top of the Reverb assigned to the entire sound range. When Distortion and Chorus are both desired for a guitar sound, improve the original guitar sound in EDIT PROGRAM so that it does not require Enhancer.

③ Trying Rotary Speaker on other instruments

Rotary speaker is usually used for, but not limited to, organ sounds.

Using Effects in Multi Play

In Multi, up to 8 different programs can be combined as Timbres. If you have selected enough effects for each of programs however, you may not be able to enjoy the advantage of this effect system. The effect unit is, though a two – channel system, limited to each of the Programs or Combinations. In other words, you cannot select different effects to each of the Timbres in Multi.

The best way to avoid the lack of effects in Multi is to decide on how you wish to assign the effects while you are in EDIT PROGRAM.

You may wish to create the same programs for Single and Multi settings and store them in two separate banks.

① Effect Setting for Rhythm Section

Effect selections are made for a rhythm section that includes bass, drums and guitar. Refer to the diagram below.

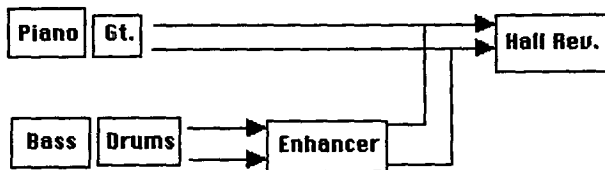

The point here is that Enhancer is assigned only to the bass and drum set in order to increase the presence of the sound. The rest of this section is programmed with Hall Reverb but Live Stage Reverb can be also selected to simulate the excitement of live performances.

② Making a careful decision to use Reverb

Reverb is such an important effect and it is used in almost all cases of sound making. If one of the two Effect units is reserved for Reverb to provide an overall reverberation, the other Effect unit must be rather used for specific sound making, for example with Chorus or Distortion. However, one Effect unit is sometimes not enough for complex programming process. In this case, if a Reverb effect is needed to just provide an overall reverberation, an external Reverb unit can be connected to the 01/WP-01/W instead of using up one of the two built-in Effect units. With an external Reverb unit, the 01/WP-01/W's two Effect units can be used for two specific Timbres. For example, Enhancer is selected for both acoustic piano and drum set and Distortion is selected for guitar, and all of these sounds can go through a Reverb outside the 01/WP-01/W.

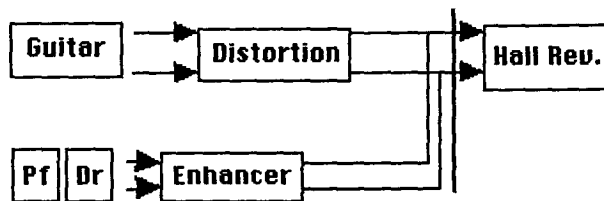

V : Creating Sounds

This section describes the actual sound making process on the 01/WFD•01/W by referring to sample procedures and Program Charts for each of typical instrument sounds. The following popular sounds are illustrated in the sample procedures.

- Piano Group
- Organ Group
- Strings Group
- Brass Group
- Guitar/Bass Group

Most of the above programs are made with a Single Oscillator and are useful for saving the number of voices when used in Multi.

Combining two programs

A dual sound can be achieved by creating a program with Double Oscillators but it can also be achieved by layering two Single programs into the same Combination.

For example, a Honky – Tonk piano can be created by layering two Single Oscillator piano programs at a slightly detuned pitch. Once you have prepared Single Oscillator programs, you can easily create other sophisticated sounds by just layering them into the Combination.

Making a dual sound with Programs

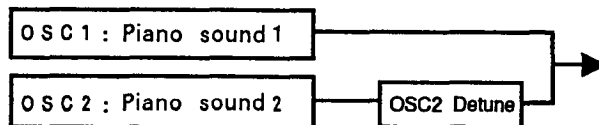

Making a dual sound with Combination

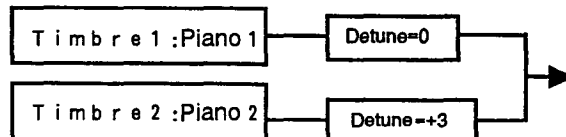

Be Creative with Multisounds

Some of the Multisounds are named with specific instrument names such as Piano or Brass but these sounds are not limited to the use suggested by their names. You should use any programs rather freely whenever the sound inspires you to play in a specific playing situation.

About Program Charts

The following sample Program Charts include only the basic parameters to construct the sound for each program. Joystick, aftertouch, effects and other controlling parameters are up to each player's artistic concept or performing style, thus not listed in the Charts.

Acoustic Piano

OSC		VDF1		VDA1		P.Mod	
OSC MODE	SINGLE	Cutoff	34	Vel.sens	57	Int	0
Assign	POLY	KBD Tr	+12	KBD Tr	0	VDF Mod	
Hold	OFF	EG Int	62	EGTime VS	0		
OSC1 MS	000:	Vel.sens	42	EG Time KT	0	Int	0
OSC1 Lvl	99	EG Time	5				
Octave	8'	Vel.sens	48				
		KBD Tr	0				
[Pitch EG]		[EG]		[EG]			
EG Int	0	AT	0	AT	0		
		A	99	A	87		
Emp,WS		DT	43	DT	24		
Int	0	BP	68	BP	99		
Vel.sens	0	ST	97	ST	64		
WS 1	OFF	S	0	S	0		
		RT	32	RT	0		
		R	0				
Effect	Placement	Effect 1		Effect 2			
	Serial	Enhancer		Hall			

Since most of the basic parameters are already set in the Chart up to the VDF and VDA, try to adjust the Velocity under your choice. You may use Enhancer to strengthen the sound. A Honky – Tonk piano may be also created by layering the same programs at a slightly detuned pitch in the Combination mode.

While an acoustic piano program is programmed, the sound becomes much more natural by simply editing the envelope to a gradually decaying curve. You can further create a more simulated sound by properly setting the VDF envelope so that tone becomes softer as the sound decays. You may also create a hammer sound in OSC2 and blend it with OSC1 in Double Oscillator mode.

Electric piano tends to have a longer decaying curve than that of an acoustic piano. To set this curve on the VDF envelope, set the EG Int around +50 and decrease the Cutoff value. The key to making a good envelope is to prepare a longer VDA envelope so that it sounds a little longer than expected, and then improve the shape of the VDF envelope.

Electric Piano

A spacial chorus – like effect can be created in Combination by layering the same electric piano programs at a slightly detuned pitch.

OSC		VDF1		VDA1		P.Mod	
OSC MODE	SINGLE	Cutoff	80	Vel.sens	53	Int	0
Assign	POLY	KBD Tr	0	KBD Tr	0		
Hold	OFF	EG int	99	EGTime VS	0	VDF Mod	
OSC1 MS	001:	Vel.sens	0	EG Time KT	0	Int	0
OSC1 Lvl	99	EG Time	0				
Octave	8'	Vel.sens	+99				
		KBD Tr	0				
[Pitch EG]		[EG]		[EG]			
EG Int	0	AT	+99	AT	2		
		A	0	A	83		
Emp,WS		DT	10	DT	26		
Int	0	BP	0	BP	99		
Vel.sens	0	ST	0	ST	73		
WS 1	OFF	S	0	S	0		
		RT	0	RT	8		
		R	0				

Effect	Placement	Effect 1	Effect 2
	Serial	Chorus	Hall

Electric Organ

OSC		VDF1		VDA1		P.Mod	
OSC MODE	SINGLE	Cutoff	80	Vel.sens	0	Int	0
Assign	POLY	KBD Tr	0	KBD Tr	0	VDF Mod	
Hold	OFF	EG int	0	EGTime VS	0		
OSC1 MS	012:	Vel.sens	0	EG Time KT	0	Int	0
OSC1 Lvl	70	EG Time	0				
Octave	8'	Vel.sens	0				
[Pitch EG]		[EG]		[EG]			
EG Int	0	AT	0	AT	0		
		A	0	A	99		
Emp,WS		DT	0	DT	99		
Int	0	BP	0	BP	99		
Vel.sens	0	ST	0	ST	0		
WS 1	OFF	S	0	S	99		
		RT	0	RT	0		
		R	0				

Effect	Placement	Effect 1	Effect 2
	Serial	Rotary Speaker	Hall

This initial organ sound only contains basic sound parameters and does not include other editing parameters such as the EG, MG, aftertouch, or the values for the VDA and VDF. To obtain a variety of organ sounds, this organ sound may be layered in Combination, or create another organ sound with Double Oscillator.

The most suitable effect for organ is, of course, Rotary Speaker. However, using Rotary Speaker in Multi limits the

possibility of using other effects. Try to use this effect only for organ sounds in the Program mode.

Strings

OSC		VDF1		VDA1		P.Mod	
OSC MODE	SINGLE	Cutoff	78	Vel.sens	48	Int	0
Assign	POLY	KBD Tr	+17	KBD Tr	0	VDF Mod	
Hold	OFF	EG int	0	EGTime VS	0		
OSC1 MS	091:	Vel.sens	0	EG Time KT	0	Int	0
OSC1 Lvl	99	EG Time	0				
Octave	8'	Vel.sens	0				
[Pitch EG]		[EG]		[EG]			
EG Int	0	AT	0	AT	30		
		A	0	A	99		
Emp,WS		DT	0	DT	0		
Int	0	BP	0	BP	99		
Vel.sens	0	ST	0	ST	99		
WS 1	OFF	S	0	S	0		
		RT	0	RT	32		
		R	0				

Effect	Placement	Effect 1	Effect 2
	Serial	Chorus	Hall

Already selected parameters in the Chart are only the VDA envelope, the VDF Cutoff and the KBD Track. If this setting is not enough for realizing your image, create a dual sound in Double Oscillator mode. While in Double Oscillator mode, shifting the values for the parameters of frequency and intensity MG 1 and MG 2 will expand the tone color in various ways.

After the basic sound is determined, it is also necessary to select effects with a proper routing. Selecting Chorus and Reverb in Serial placement is one of many ways to add natural reverberation with spacious expansion.

Making a Strings sound itself is rather simple operation but many other functions will be needed in actual performances such as a Velocity controlled envelope length.

Brass Ensemble

OSC		VDF1		VDA1		P.Mod	
OSC MODE	SINGLE	Cutoff	52	Vel.sens	48	MG1	TRI
Assign	POLY	KBD Tr	0	KBD Tr	0	Freq	42
Hold	OFF	EG int	93	EGTime VS	0	Int	12
OSC1 MS	086:	Vel.sens	0	EG Time KT	0	DL	15
OSC1 Lvl	99	EG Time	0				
Octave	8'	Vel.sens	0				
		KBD Tr	0				
[Pitch EG]		[EG]		[EG]			
EG Int	0	AT	8	AT	3		
		A	99	A	99		
Emp.WS		DT	17	DT	38		
Int	0	BP	62	BP	87		
Vel.sens	0	ST	62	ST	97		
WS 1	OFF	S	0	S	78		
		RT	15	RT	17		
		R	21				

Effect	Placement	Effect 1	Effect 2
	Serial	Early Ref.	Hall

The Brass instruments' unique characteristics at initial attack involves the delicate sound change. This is simulated by the VDF envelope in the above Chart since the Brass sound depends on this initial attack. When trying various settings for the VDF parameter, you may change the Cutoff and EG settings without changing the EG Int setting. Changing the EG Int values results in altering the range of sound change at initial attack.

To obtain an ensemble impact to the sound, two of this Brass sound may be used programmed in Double Oscillator mode. This sound is often layered with Strings in actual performances.

Electric Guitar

OSC		VDF1		VDA1		P.Mod	
OSC MODE	SINGLE	Cutoff	75	Vel.sens	48	Int	0
Assign	POLY	KBD Tr	0	KBD Tr	0		
Hold	OFF	EG int	99	EGTime VS	0	VDF Mod	
OSC1 MS	032:	Vel.sens	0	EG Time KT	0	Int	0
OSC1 Lvl	99	EG Time	0				
Octave	8'	Vel.sens	0				
		KBD Tr	0				
[Pitch EG]		[EG]		[EG]			
EG Int	0	AT	+99	AT	0		
		A	0	A	99		
Emp,WS		DT	40	DT	28		
Int	0	BP	0	BP	87		
Vel.sens	0	ST	0	ST	73		
WS 1	OFF	S	0	S	0		
		RT	0	RT	12		
		R	0				

Effect	Placement	Effect 1	Effect 2
	Serial	Distortion	Hall

The above Chart indicates a typical parameter setting for a guitar sound. This contains shorter decaying envelopes than that of the electric piano and its tone color can be controlled by the VDF.

Since the guitar sound is characterized by its initial attack, this can be simulated by setting a faster decay time or adding a picking noise in Double mode. To create a picking noise, choose the closest sound from the Multi sound list and edit it with a short envelope.

Also a twelve – string guitar sound can be achieved by adding an octave raised sound in Double Oscillator mode. Try various effects such as Chorus and Distortion since the image of the original sound can be easily improved or changed by effects.

Electric Bass

OSC		VDF1		VDA1		P.Mod	
OSC MODE	SINGLE	Cutoff	75	Vel.sens	48	Int	0
Assign	POLY	KBD Tr	0	KBD Tr	0		
Hold	OFF	EG int	99	EGTime VS	0	VDF Mod	
OSC1 MS	032:	Vel.sens	0	EG Time KT	0	Int	0
OSC1 Lvl	99	EG Time	0				
Octave	16'	Vel.sens	0				
		KBD Tr	0				
[Pitch EG]		[EG]		[EG]			
EG Int	0	AT	+99	AT	0		
		A	0	A	99		
Emp,WS		DT	40	DT	28		
Int	0	BP	0	BP	87		
Vel.sens	0	ST	0	ST	73		
WS 1	OFF	S	0	S	0		
		RT	0	RT	12		
		R	0				

Effect	Placement	Effect 1	Effect 2
	Serial	Enhancer	Hall

This Program Chart includes identical parameter settings to that of electric guitar. However, too much editing of the VDF will lose the presence of the bass sound in ensemble situations. Try to stick to Single Oscillator mode and make as simple a sound as possible because layering bass sounds will do nothing but evasing the presence of the sound unless a chorus effect is desired.

For example, you may use Enhancer to give greater definition to the sound. You may also create a bass drum sound with a short envelope and blend it with the attack part of the bass in Double Oscillator mode.

VI : Recording with a Sequencer

The 01/WP01/W is built in with a 16 – track sequencer to allow complete self – production of your original songs with multi – timbral instrumentation. This section describes some of the easy and effective ways to enjoy sequencer recording. Before starting a recording, you should decide on the following important points.

①Choosing a Recording Mode

In the 01/WP01/W one of the following three modes can be selected for making each track of a song.

•Real Time Recording

This mode is good for preserving musical feel or for those who are used to playing the keyboard.

•Step Recording

Since data for each note can be specified mostly by numeric value, this is useful for recording phrases that are difficult to play by hand.

•Pattern Method

Each track of a song can be made by combining several patterns that are separately recorded. This is especially useful for repeating patterns such as a drum part.

Select the best recording method for the nature of each part.

②Determining a Quantizing Resolution

The quantizing function automatically corrects the timing of all notes played in Real Time recording to a selected beat length. When the resolution is set to Hi, all notes will be recorded at the selected basic resolution for each song (a quarter – note = 96 or 48).

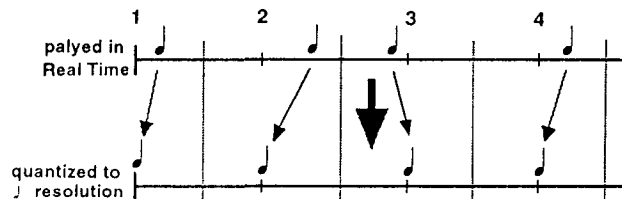

③ Selecting Programs for each Track

The 01/WP-01/W can provide a maximum of 16 programs by assigning a separate program to each of 16 tracks (within the maximum number of voices, 32). Be sure to make an advance plan for track structure.

④ Selecting Panpot and Volume for each Track

This is important for mixing each track. While you are selecting panpot and volume, you may want to plan for effect settings also.

The points discussed above will provide easy and effective recording with the least time and effort. Now you can make any kind of songs up to your creativity because you now know all the basics of the sequencer's operation.

Recording a Rhythm and Melody

On the next few pages are guide procedures for recording a song with keyboard, guitar, bass and drum tracks. A sample song chart is illustrated as below.

※Make sure you number each of drum patterns (P00~P02), beforehand.

Sample Song

The musical score is titled "Sample Song" and is written in 4/4 time. It consists of four staves: Keyboard (Kb), Guitar (Gl), Bass, and Drum. The Keyboard track shows chords Am, Am7onG, D7onF#, F, and E7. The Guitar track is marked "With Distortion". The Bass track shows a rhythmic line. The Drum track shows four patterns labeled Pattern00, Pattern02, Pattern00, and Pattern02, with a "Fill in" at the end. The score is in 4/4 time and includes a piano (p) dynamic marking.

① Selecting Song Tracks and Programs

Page "0" is used for selection of programs to Tracks 1 – 16. Quantize works after recording each track. For the sample song keyboard, guitar, bass and drums are recorded for Tracks 1 – 4, respectively. Select programs by shifting the cursor to each track on the screen.

※Before recording, call up the Song parameter on page "0" and select a song to be recorded. If data already exists in the selected song, call up the Erase Song parameter on page "5" to erase the data.

SONG1 P5:EDIT SONG

Step Recording	Bounce Track
Create CTRL Data	Copy Track
Event Edit	Erase Song
Erase Track	Append Song

SONG1

[ERASE]

②Checking Programs on Each Track

When the program for each track is selected, check the sound on each track by playing the keys.

SONG1 New Song

▶Track

A01	A14	A16	A98	A00	A00	A00	A00
A00	A00	A00	A00	A00	A00	A00	A00

SONG1 **Trk04** M001 4/4 QUWR
J=120:MAN Q:HI M:OFF Edit:PRG

③Recording a Drum Part with Patterns

Since the drums part in the sample song consists of 3 patterns, create patterns 1 – 3 by the Pattern method and combine them. To create each pattern, use Pattern Real Time Recording and Pattern Step Recording on page 7. The figure below illustrates making P00 – P02 by Real Time Recording.

SONG1 P7:PATTERN

▶Pattern Number

Real Time Rec	Erase Pattern
Step Recording	Get From Track
Event Edit	Bounce Pattern
Pattern Parameter	Copy Pattern

P00 J=120 M-- Hi MM:OFF

Arrange the created patterns on Track 4 by using Put/Copy Pattern.

SONG1 P6:EDIT MEAS

▶Dest Track

Quantize	Erase Measure
Shift Note	Copy Measure
Modify Velocity	Insert Measure
Delete Measure	Put/Copy Pattern

Pat00 → **Trk04** M001 [PUT][CPY]

④Recording a Bass Part by Real Time Recording

Check the following parameters before recording

•Setting a Lead – in measure

Call up the Metronome L.in parameter on page 9 and set the number of lead – in measures to either 1 or 2.

•Setting a Quantize Resolution

Set a resolution at Q: on page 0.

When the above parameters are set properly with Track 3 selected, go back to page 0 and start recording. Select Overwrite for the recording mode.

SONG1 New Song				▶REC Mode			
A01	A14	A16	A98	A00	A00	A00	A00
A00	A00	A00	PLAY	A00	A00	A00	A00
SNG1 Tr03 M005 4/4				DUWR			
J=120:MAN Q:HI M:ON				Edit:PRG			

Press the START/STOP key after pressing the REC/WRITE key. Recording starts after the selected number of lead – in measures. Pressing the START/STOP key again stops the recording.

SONG1 New Song				▶ 99% Free			
A01	A14	A16	A98	A00	A00	A00	A00
A00	A00	A00	REC PLAY	A00	A00	A00	A00
SNG1 Tr03 M002 4/4				DUWR			
J=120:MAN Q:HI M:ON				Edit:PRG			

A recorded song can be played back immediately by pressing the START/STOP key.

SONG1 New Song				▶ 99% Free			
A01	A14	A16	A98	A00	A00	A00	A00
A00	A00	A00	PLAY PLAY	A00	A00	A00	A00
SNG1 Tr03 M003 4/4				DUWR			
J=120:MAN Q:HI M:ON				Edit:PRG			

Next, record the keyboard and melody parts by Real Time Recording.

⑤Setting Monitor Tracks ON/OFF

While recording is continued, any of the song data can be monitored whenever necessary by setting PLAY/MUTE on page 0.

SONG1 New Song				▶A14:E Guitar &			
A01	A14	A16	A98	A00	A00	A00	A00
PLAY	PLAY	PLAY	PLAY	A00	A00	A00	A00
SNG1 Tr02 M001 4/4				DUWR			
J=120:MAN Q:HI M:ON				Edit:PRG			

⑥Correcting track data by Auto Punch IN/OUT

If the 3rd through the 4th measure of the keyboard track needs to be corrected for example, Auto Punch IN/OUT can be used to re – record only the specified measures in stead of recording from the beginning again. This can be done by selecting Auto Punch IN for the recording mode.

Set the recording mode as AOTP first and select Track 1, then set both the punch in measure and the punch – out measure.

SONG1 New Song				▶Punch Out Bar			
A01	A14	A16	A98	A00	A00	A00	A00
PLAY	PLAY	PLAY	PLAY	A00	A00	A00	A00
SNG1 Tr01 M003 4/4				AOTP:003 → 004			
J=120:MAN Q:HI M:ON				Edit:PRG			

Select the number of measure(s) between the starting measure for play – back and the punch – in measure by setting the Location Measure.

SONG1 New Song								▶Measure
A01	A14	A16	A98	A00	A00	A00	A00	
PLAY	PLAY	PLAY	PLAY					
A00	A00	A00	A00	A00	A00	A00	A00	
SONG1 Tr01 0000 4/4				AUTP:003 → 004				
J=120:MAN Q:HI M:ON				Edit:PRG				

Start recording and play along with the monitoring tracks, then only the specified measure will be re – recorded.

A sample MIDI system around 01WFD • 01/W

The 01/WFD•01/W is built in with a complete MIDI system architecture. However, this can be further expanded to more sophisticated MIDI system by adding external MIDI sound sources such as the Wavestation and the S3.

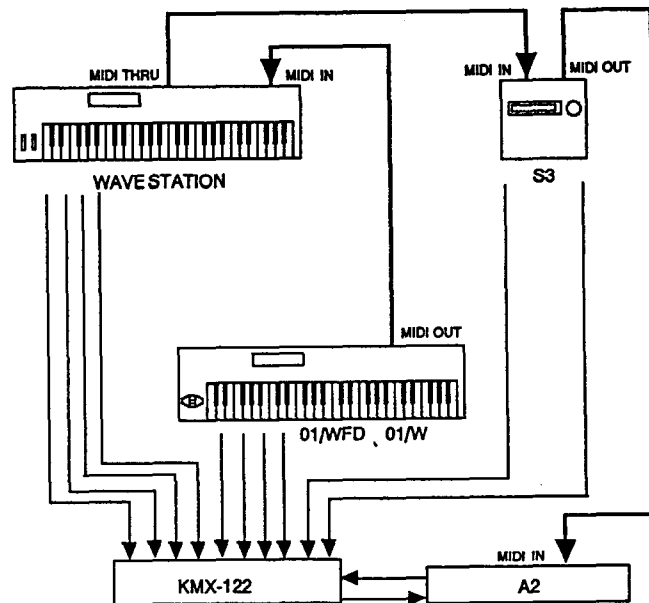

① Making full use of each instrument's features

One of the main features of the Wavestation is the advanced vector synthesis that allows you to select up to 4 of the many waveforms + 32 wave sequences and mix them in any desired manner with the vector joystick. The Wavestation is also the first synthesizer to make the wave sequencing possible. Since the Wavestation is also 32 voices polyphonic, combining this with the 01/WFD•01/W will allow the maximum of 64 voices.

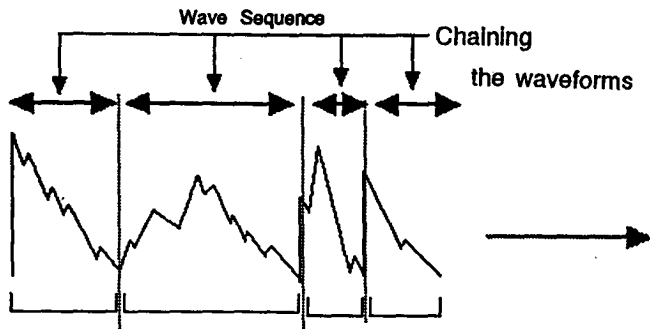

The S3 is a complete rhythm workstation where all operations pertinent to rhythm parts are done in one unit. Therefore, in a MIDI system with the S3, you can let the S3 control all drum and percussion parts while you play other sound oriented parts on the 01/WFD•01/W and the Wave - station.

② Use of sequencer

Since the 01/WFD•01/W is equipped with 16 track sequencer while the Wavestation is without a sequencer, it is a good idea to control the sequencer operation on the 01/WFD•01/W. (The S3 also contains an 8 track sequencer, but all data controlling operation should be integrated into a single unit such as, in this case, the 01W•01WFD.) Refer to the table below for sample assignment of track. In this example, track 1 through 9 and 11 through 16 are assigned so that up to 4 voices can become available for use in each track. Some tracks that use monophonic instruments (such as bass) can increase the number of other tracks' voices to, in this case, over 4 voices.

1	01/WFD•01/W(PIANO)
2	01/WFD•01/W(BASS)
3	01/WFD•01/W(GUITAR)
4	01/WFD•01/W(FLUTE)
5	01/WFD•01/W(OBOE)
6	01/WFD•01/W(CLARINET)
7	01/WFD•01/W(VLN)
8	01/WFD•01/W(VCL)
9	WAVESTATION(BRASS)
10	S3(Rythm)
11	WAVESTATION(SAX)
12	WAVESTATION(SYN-CHORD)
13	WAVESTATION(SYN-LEAD)
14	WAVESTATION(SEQ1)
15	WAVESTATION(SEQ2)
16	WAVESTATION(SE)

③ Wave sequence the Wavestation

Wavestation's wave sequence can be synchronized with the MIDI clock. This will easily allow making of rhythm combinations with the S3.

④ Setting of effects

Since each of the 01/WFD•01/W, the Wavestation and the S3 is equipped with two – channel digital effect processors, you can now use 6 effect processors altogether. In this example, the 01/WFD•01/W and the Wavestation are connected with an external reverb effect while the S3 uses its built – in effects for itself. In this setting up to 4 separate effects can be assigned to each timbre on the 01/WFD•01/W and the Wavestation. For example, after assigning Distortion to guitar, Enhancer to piano, Stereo Chorus to strings and stereo Delay to the Wave sequence part, you can use a reverb of the external effect to the rest of the parts. It is always smart to use an external effect for improving overall sound and save the built – in effects for coloring the individual sounds.

KORG

KORG INC.

15 - 12, Shimotakaido 1 - chome, Suginami - ku, Tokyo, Japan.

©KORG INC. 1991

0307 DTH PRINTED IN JAPAN



Music Workstation

01/W FD

01/W

Owner's Manual

 AI² Synthesis System

KORG

Ⓔ

⑦

IMPORTANT SAFETY INSTRUCTIONS

WARNING — When using electric products, basic precautions should always be followed, including the following.

1. Read all the instructions before using the product.
2. Do not use this product near water — for example, near a bathtub, washbowl, kitchen sink, in a wet basement, or near a swimming pool, or the like.
3. This product should be used only with a cart or stand that is recommended by the manufacturer.
4. This product, either alone or in combination with an amplifier and headphones or speakers, may be capable of producing sound levels that could cause permanent hearing loss. Do not operate for a long period of time at high volume level or at a level that is uncomfortable. If you experience any hearing loss or ringing in the ears, you should consult an audiologist.
5. The product should be located so that its location or position does not interfere with its proper ventilation.
6. The product should be located away from heat sources such as radiators, heat registers, or other products that produce heat.
7. The product should be connected to a power supply only of the type described in the operating instructions or as marked on the product.
8. The power-supply cord of the product should be unplugged from the outlet when left unused for a long period of time.
9. Care should be taken so that objects do not fall and liquids are not spilled onto the enclosure through openings.
10. The product should be serviced by qualified service personnel when:
 - A. The power-supply cord or the plug has been damaged; or
 - B. Objects have fallen, or liquid has been spilled into the product; or
 - C. The product has been exposed to rain; or
 - D. The product does not appear to operate normally or exhibits a marked change in performance; or
 - E. The product has been dropped, or the enclosure damaged.
11. Do not attempt to service the product beyond that described in the user-maintenance instructions. All other servicing should be referred to qualified service personnel.

SAVE THESE INSTRUCTIONS

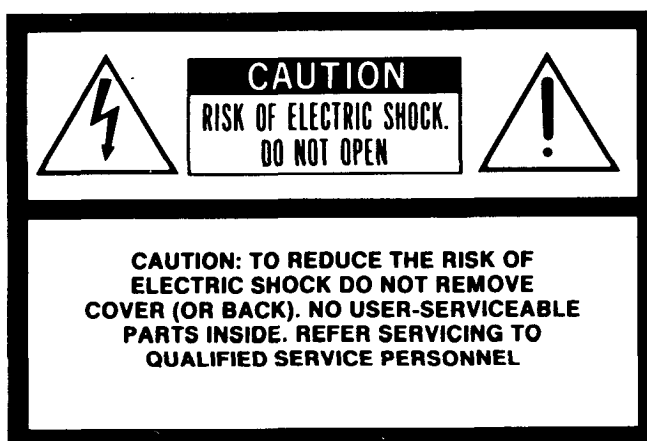



The lightning flash with arrowhead symbol, within an equilateral triangle, is intended to alert the user to the presence of uninsulated "dangerous voltage" within the product's enclosure that may be of sufficient magnitude to constitute a risk of electric shock to persons.



The exclamation point within an equilateral triangle is intended to alert the user to the presence of important operating and maintenance (servicing) instructions in the literature accompanying the product.

GROUNDING INSTRUCTIONS

This product must be grounded. If it should malfunction or breakdown, grounding provides a path of least resistance for electric current to reduce the risk of electric shock. This product is equipped with a cord having an equipment-grounding conductor and a grounding plug. The plug must be plugged into an appropriate outlet that is properly installed and grounded in accordance with all local codes and ordinances.

DANGER — Improper connection of the equipment-grounding conductor can result in a risk of electric shock. Check with a qualified electrician or serviceman if you are in doubt as to whether the product is properly grounded. Do not modify the plug provided with the product — if it will not fit the outlet, have a proper outlet installed by a qualified electrician

THE FCC REGULATION WARNING

This equipment generates and uses radio frequency energy and if not installed and used properly, that is, in strict accordance with the manufacturer's instructions, may cause interferences to radio and television reception. It has been type tested and found to comply with the limits for a class B computing device in accordance with the specifications in Subpart J of Part 15 of FCC Rules, which are designed to provide reasonable protection against such interference in a residential installation. However, there is no guarantee that interference will not occur in a particular installation. If this equipment does cause interference to radio or television reception, which can be determined by turning the equipment off and on, the user is encouraged to try to correct the interference by one or more of the following measures:

- Reorient the receiving antenna.
- Relocate the equipment with respect to the receiver.
- Move the equipment away from the receiver.
- Plug the equipment into a different outlet so that equipment and receiver are on different branch circuits.

If necessary, the user should consult the dealer or an experienced radio/television technician for additional suggestions. The user may find the following booklet prepared by the Federal Communications Commission helpful: "How to Identify and Resolve Radio-TV Interference Problems". This booklet is available from the US Government Printing Office, Washington, D.C. 20402, stock No. 004-000-00345-4.

CANADA

THIS DIGITAL APPARATUS DOES NOT EXCEED THE "CLASS B" LIMITS FOR RADIO NOISE EMISSIONS FROM DIGITAL APPARATUS SET OUT IN THE RADIO INTERFERENCE REGULATION OF THE CANADIAN DEPARTMENT OF COMMUNICATIONS.

LE PRESENT APPAREIL NUMERIQUE N'EMET PAS DE BRUITS RADIOELECTRIQUES DEPASSANT LES LIMITES APPLICABLES AUX APPAREILS NUMERIQUES DE LA "CLASSE B" PRESCRITES DANS LE REGLEMENT SUR LE BROUILLAGE RADIOELECTRIQUE EDICTE PAR LE MINISTERE DES COMMUNICATIONS DU CANADA.

Thank you for purchasing the Korg 01/WFD•01/W Music Workstation. To ensure long, trouble-free operation, please read this manual carefully.

Precautions

■ Location

Using the unit in the following location can result in malfunction.

- In direct sunlight
- Locations of extreme temperature or humidity
- Excessively dusty or dirty locations
- Locations of excessive vibration

■ Power supply

Please connect the AC power cable to an AC outlet of the correct voltage. Do not connect it to an AC outlet of voltage other than for which your unit is intended.

■ Interference with other electrical devices

This unit contains a microcomputer. Radios and televisions placed nearby may experience reception interference. Operate this unit at a suitable distance from radios and televisions.

■ Handling

To avoid breakage, do not apply excessive force to the switches or controls.

■ Care

If the exterior becomes dirty, wipe it with a clean, dry cloth. Do not use liquid cleaners such as benzene or thinner, or cleaning compounds or flammable polishes.

■ Keep this manual

After reading this manual, please keep it for later reference.

How to use this manual

- First, read the “Basic operation” section while actually operating the 01/WFD•01/W.
 - This will help you to understand the basics of operating the 01/WFD•01/W. Follow the directions to learn the function of each key and display.

- Next, glance through the “Reference” section.
 - This will give you an idea of the possibilities of the 01/WFD•01/W, and points to remember.
- When necessary, refer to the explanations for each function you need to use.



This manual covers both the 01/WFD and the 01/W(no FD). These models differ in the following points.

	01/WFD	01/W
Floppy disk drive	3.5 inch 2DD built in	None
Disk mode switch	Yes	None
INT ↔ CARD switch	The bank selected changes with each press of the BANK key (A → B → C → D → A...). Banks A and B refer to internal memory, while C and D refer to a card.	Switch between INT ↔ CARD each time you press INT/CARD key
Memory backup	Sequencer data (settings and musical data of each song, and all patterns) is not backed up	All data is backed up
Number of sequencer steps	48,000 steps	7,000 steps

Features of the 01/WFD•01/W

1. All-digital AI square synthesis system

From the tone generator (a capacity of 48 Mbits) through the filters and effect units, all audio is handled in digital form, ensuring high-quality sound with no signal loss.

2. A wide variety of Multisounds (waveforms)

The 01/WFD•01/W contains 255 preset Multisounds (multi-sampled PCM waveforms), providing a wide variety of ingredients for flexible sound creation. Additional Multisounds can be supplied by inserting optional PCM cards, allowing you to create sounds that were not possible for previous synthesizers.

3. Combinations allow flexible performance possibilities

With 100 combinations available in each bank, the two banks provide a total of 200 combinations which can be used to combine sounds for performance. The 01/WFD•01/W will function as an 8-timbre multi-timbral tone generator, making it an ideal addition to any sequencing system.

4. Editable Drum Kits assist in song creation

The 01/WFD•01/W provides 111 types of drum sounds, and settings and tuning for each drum sound can be stored in two Drum Kits per bank.

5. Multi-track sequencer with flexible functionality

The built-in sequencer allows you to record 16-track data using realtime or step recording, and you can edit individual data events. By using Patterns for frequently-appearing motifs, you can save memory and speed up the process of song creation.

6. Multi Digital Effect processor for creative sounds

The 01/WFD•01/W contains a Multi Digital Effect processor that provides up to 4 simultaneous effects, and can also be used as two completely independent stereo effect systems. Not only delay and reverb, but also equalizer, distortion, rotary speaker, and many other types of effects are provided.

7. Edit even while playing

Not only sounds, but even Combination parameters and Sequencer settings can be easily edited while you play.

8. Wave shaping, for producing a more profound sound.

A new radical wave shaping allows you to create sounds more complex and richer in nuance than the original.

9. Compatibility through use of Standard MIDI Files

It is possible to use Standard MIDI Files saved to floppy disk, providing compatibility with other devices and enabling the use of sequence data from many different sources.

The backup battery

The 01/WFD•01/W contains a battery that preserves its memory settings when the power is turned off. When the display

indicates "Battery Low", please contact your dealer or a nearby Korg service center to have the battery replaced.

MEMORY CARD RAM

◆ The RAM card (SRC-512) requires battery power in order to preserve data in memory. The included lithium battery (type CR2016) should be put in place before use.

① Installing the battery

Turn the card over to the side without the terminal. You will find a slot in the battery holder.

Install the lithium battery in the holder with the "+" side up.

② Write Protect Switch

No data can be written on the card when this switch is set to "ON". To preserve data, set this switch to ON, except when writing new data.

③ Replacing Lithium Battery

Power from the lithium battery is used to protect data held in memory. The battery should be replaced once a year. However, battery life is shortened if kept at temperatures exceeding 40 degrees centigrade. (104 Fahrenheit)

Always use a CR2016 type lithium battery.

When replacing the battery, leave the card in the unit with unit power ON. This will preserve the contents of the memory. If the card is removed before battery replacement, memory contents will be lost.

* The names of the Programs, Combinations, Multisounds, etc. appearing in the displays given as examples in this manual do not necessarily correspond to any internal data.

TABLE OF CONTENTS

<p>FRONT PANEL 2</p> <p>REAR PANEL 3</p> <p>BASIC OPERATION 4</p> <p style="padding-left: 20px;">CONNECTIONS 4</p> <p style="padding-left: 20px;">HOW THE 01/WFD • 01/W IS ORGANIZED 5</p> <p style="padding-left: 20px;">PLAYING A COMBINATION (A COMBINATION OF SEVERAL SOUNDS) 8</p> <p style="padding-left: 20px;">HOW TO USE THE SEQUENCER 10</p> <p style="padding-left: 20px;">HOW TO RECORD 10</p> <p style="padding-left: 20px;">KEY AND SLIDER FUNCTION 11</p> <p style="padding-left: 20px;">HOW TO CREAT YOUR OWN SOUNDS 14</p> <p style="padding-left: 20px;">ABOUT THE 01/WFD • 01/W'S MEMORY 15</p> <p style="padding-left: 20px;">HOW TO INPUT DATA 16</p> <p style="padding-left: 20px;">THE DISK DRIVE AND FLOPPY DISKS 17</p> <p>APPLICATION SECTION 19</p> <p>HOW TO READ A DISPLAY PAGE CHART 19</p> <p>1. PROGRAM MODE 20</p> <p style="padding-left: 20px;">EDITING WHILE IN PROGRAM MODE (“PERFORMANCE EDITING”) 20</p> <p style="padding-left: 20px;">HOW PERFORMANCE EDITING AFFECTS EDIT PROGRAM PARAMETERS 21</p> <p>2. EDIT PROGRAM MODE 22</p> <p style="padding-left: 20px;">HOW THE PROGRAM PARAMETERS OF THE 01/WFD • 01/W ARE ORGANIZED 22</p> <p style="padding-left: 20px;">FUNCTIONS IN EDIT PROGRAM MODE 23</p> <p style="padding-left: 20px;">EDIT PROGRAM 25</p> <p>3. EFFECT PARAMETERS 49</p> <p style="padding-left: 20px;">EFFECT PLACEMENT 49</p> <p style="padding-left: 20px;">EFFECT PARAMETERS 82</p> <p>4. COMBINATION MODE 84</p> <p style="padding-left: 20px;">EDITING IN COMBINATION MODE 84</p> <p style="padding-left: 20px;">PERFORMANCE EDIT 85</p> <p>5. EDIT COMBINATION MODE 86</p> <p style="padding-left: 20px;">FUNCTIONS IN EDIT COMBINATION MODE 87</p> <p style="padding-left: 20px;">EDIT COMBINATION 88</p> <p>6. SEQUENCER MODE 98</p> <p style="padding-left: 20px;">HOW A SONG IS ORGANIZED 98</p> <p style="padding-left: 20px;">HOW A PATTERN IS ORGANIZED 99</p> <p style="padding-left: 20px;">SEQUENCE DATA MEMORY 100</p> <p style="padding-left: 20px;">TIME SIGNATURE 100</p> <p style="padding-left: 20px;">FUNCTIONS IN SEQUENCER MODE 101</p>	<p>SEQUENCER 103</p> <p style="padding-left: 20px;">Play 108</p> <p style="padding-left: 20px;">About realtime recording 108</p> <p style="padding-left: 20px;">Pattern opening 109</p> <p style="padding-left: 20px;">Realtime recording procedure 110</p> <p style="padding-left: 40px;">Overwrite Recording 110</p> <p style="padding-left: 40px;">Overdub recording 110</p> <p style="padding-left: 40px;">Auto Punch In recording 111</p> <p style="padding-left: 40px;">Manual punch in recording 111</p> <p style="padding-left: 40px;">Loop Recording 113</p> <p style="padding-left: 20px;">Multi-track recording 113</p> <p style="padding-left: 20px;">Synchronization with external MIDI devices 113</p> <p style="padding-left: 20px;">Step Recording 120</p> <p style="padding-left: 20px;">About Event Edit 125</p> <p>7. GLOBAL MODE 156</p> <p style="padding-left: 20px;">FUNCTIONS IN GLOBAL MODE 156</p> <p style="padding-left: 20px;">GLOBAL 157</p> <p style="padding-left: 40px;">Drum Kit 160</p> <p style="padding-left: 40px;">Program Card loading and saving 168</p> <p style="padding-left: 40px;">MIDI Data Dump 177</p> <p>8. DISK MODE (01/WFD only) 181</p> <p style="padding-left: 20px;">FUNCTIONS IN DISK MODE 181</p> <p style="padding-left: 20px;">ABOUT FILES 181</p> <p style="padding-left: 20px;">DISK 183</p> <p style="padding-left: 40px;">Loading from disk 183</p> <p style="padding-left: 40px;">Saving to disk 190</p> <p style="padding-left: 40px;">Formatting a disk 191</p> <p style="padding-left: 40px;">MIDI Data file 193</p> <p style="padding-left: 40px;">Standard MIDI file 195</p> <p>MIDI IMPLEMENTATION 199</p> <p>ERROR MESSAGES 211</p> <p style="padding-left: 20px;">Common to all modes 211</p> <p style="padding-left: 20px;">Sequencer mode 211</p> <p style="padding-left: 20px;">Disk mode (01/WFD only) 212</p> <p style="padding-left: 20px;">Global mode 213</p> <p>SPECIFICATION AND OPTIONS 214</p> <p>TROUBLESHOOTING 215</p> <p>01/W MEMORY CONFIGURATION 216</p>
------------------------------------------------------------------------------------------------------------------------------------------------------------------------------------------------------------------------------------------------------------------------------------------------------------------------------------------------------------------------------------------------------------------------------------------------------------------------------------------------------------------------------------------------------------------------------------------------------------------------------------------------------------------------------------------------------------------------------------------------------------------------------------------------------------------------------------------------------------------------------------------------------------------------------------------------------------------------------------------------------------------------------------------------------------------------------------------------------------------------------------------------------------------------------------------------------------------------------------------------------------------------------------------------------------------------------------------------------------------------------------------------------------------------------------------------------------------------------------------------------------------------------------------------------------------------------------------------------------------------------------------------------------------------------------------------------------------------------------------------------------------------------------------------------------------------------------------------------------------------------------------------------------------------------------------------------------------------------------------------------------------------------------------------------------------------------------------------------------------------------------------------------------------------------------------------------------------------------------------------------------------------------------------------------------------------------------------------------------------------------------------------------------------------	------------------------------------------------------------------------------------------------------------------------------------------------------------------------------------------------------------------------------------------------------------------------------------------------------------------------------------------------------------------------------------------------------------------------------------------------------------------------------------------------------------------------------------------------------------------------------------------------------------------------------------------------------------------------------------------------------------------------------------------------------------------------------------------------------------------------------------------------------------------------------------------------------------------------------------------------------------------------------------------------------------------------------------------------------------------------------------------------------------------------------------------------------------------------------------------------------------------------------------------------------------------------------------------------------------------------------------------------------------------------------------------------------------------------------------------------------------------------------------------------------------------------------------------------------------------------------------------------------------------------------------------------------------------------------------------------------------------------------------------------------------------------------------------------------------------------------------------------------------------------------------------------------------------------------------------------------------------------------------------------------------------------------------------------------------------------------------------------------------------------------------------------------------------------------------------------------------------------------------------------------------------------------------------------------------------------------------------

FRONT PANEL

(For the explanation of each key and slider, refer to page 11.)

- ① MASTER VOLUME slider
- ② Mode select keys
 COMBI = Combination mode
 EDIT COMBI = Edit Combination mode
 PROG = Program mode
 EDIT PROG = Edit Program mode
 SEQ = Sequencer mode
 GLOBAL = Global mode
 DISK = Disk mode (01/WFD only)
- ③ 01/WFD: BANK key
 01/W: INT/CARD key, BANK key
- ④ VALUE slider
- ⑤ Δ / ∇ keys
- ⑥ Cursor UP/DOWN keys
- ⑦ Display
- ⑧ Cursor keys (A—H)
- ⑨ PAGE+/- keys
- ⑩ NUMBER keys (0 — 9)
- ⑪ 10'S HOLD (—) key
- ⑫ COMPARE key
- ⑬ REC key
- ⑭ START/STOP key
- ⑮ RESET key

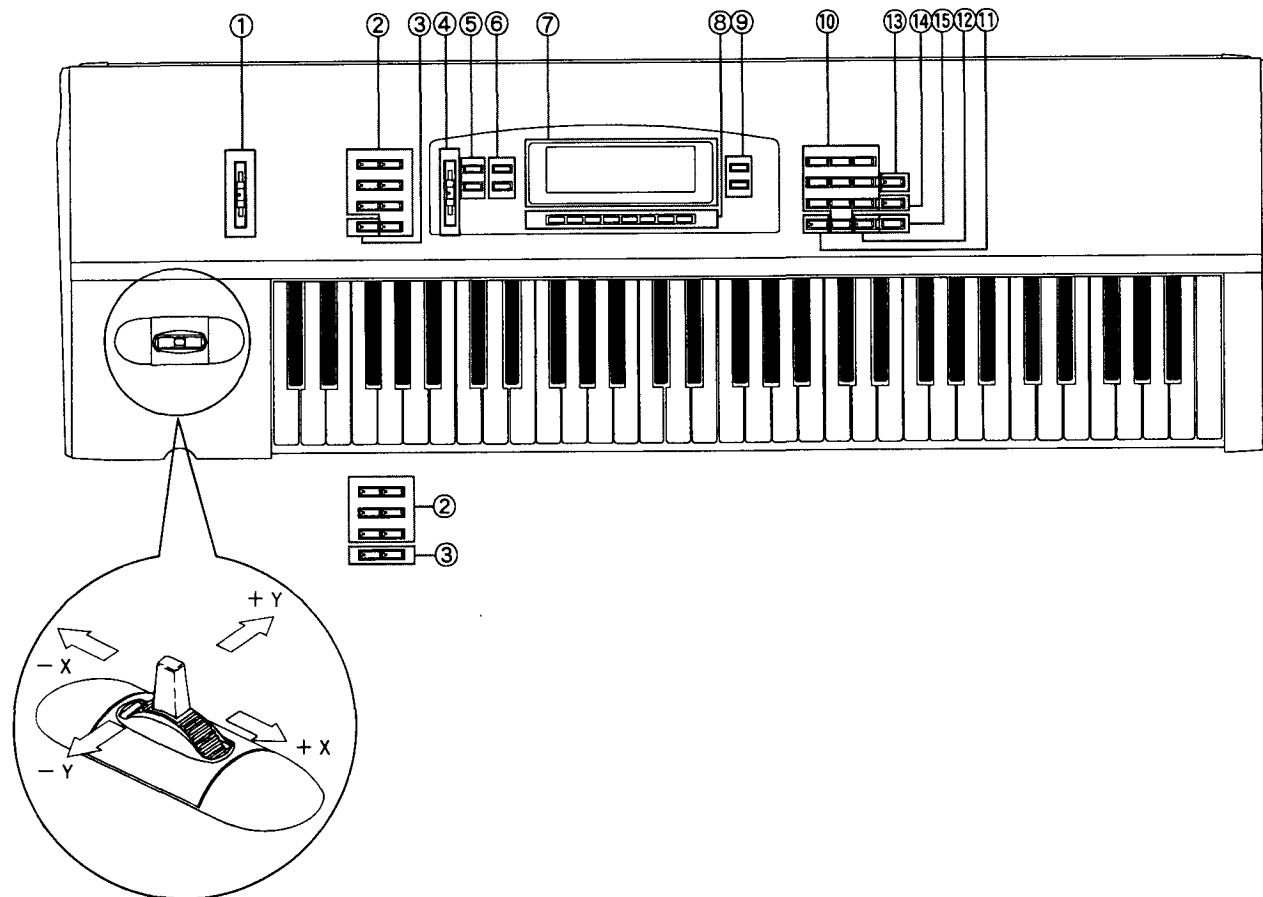

REAR PANEL

① PCM DATA slot

A card containing PCM (Multisound) data can be inserted here. Cards containing voice and sequence data should be inserted into the PROG/SEQ DATA slot, not into this slot.

② PROG/SEQ DATA slot

A card containing (or into which you will store) voice or sequence data can be inserted into this slot. PCM (Multisound) data cards should be inserted into the PCM DATA slot, not into this slot.

③ MIDI THRU jack

④ MIDI OUT jack

⑤ MIDI IN jack

⑥ DAMPER jack

A footswitch can be connected here and used as a damper pedal.

⑦ ASS. PEDAL/SW jacks (1, 2)

Pedals or footswitches can be connected to these jacks. They will function as assigned in Global mode.

⑧ OUTPUT jacks (1/L, 2/R, 3, 4)

These are the audio outputs of the 01/WFD-01/W. The output to each jack is determined by various parameters.

⑨ PHONES jack

A pair of headphones can be connected to this jack to monitor the sound of the OUTPUT 1/L and 2/R jacks.

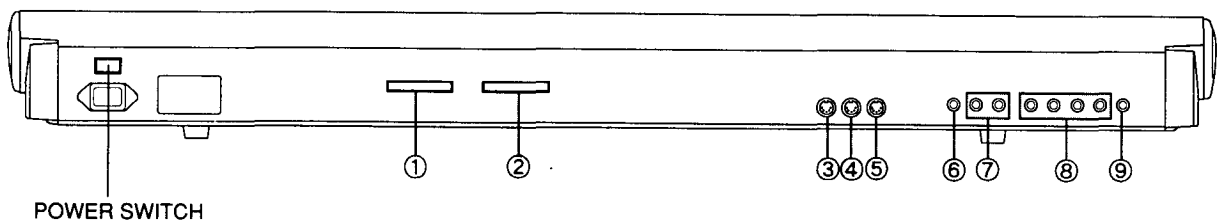

BASIC OPERATION

CONNECTIONS

- (1) First, make sure that the 01/WFD•01/W power switch (rear panel) is turned Off. Also make sure that the power of all connected equipment (amps, mixers, etc.) is turned Off. Set the volume controls of all equipment to their lowest position.
 - (2) Insert the included power cable into the rear panel power connector, and connect the other end to an AC outlet.
 - (3) Turn the 01/WFD•01/W power On.
 - (4) Turn the power of all connected equipment On, and gradually raise the volume controls of the 01/WFD•01/W and your mixer/amp system to an appropriate level.
- The range of the 01/WFD•01/W keyboard is C2 — C7 without using the Key Transpose function. (By using key transpose, you can cover any 5 octaves in the range of C-1 — C8.)

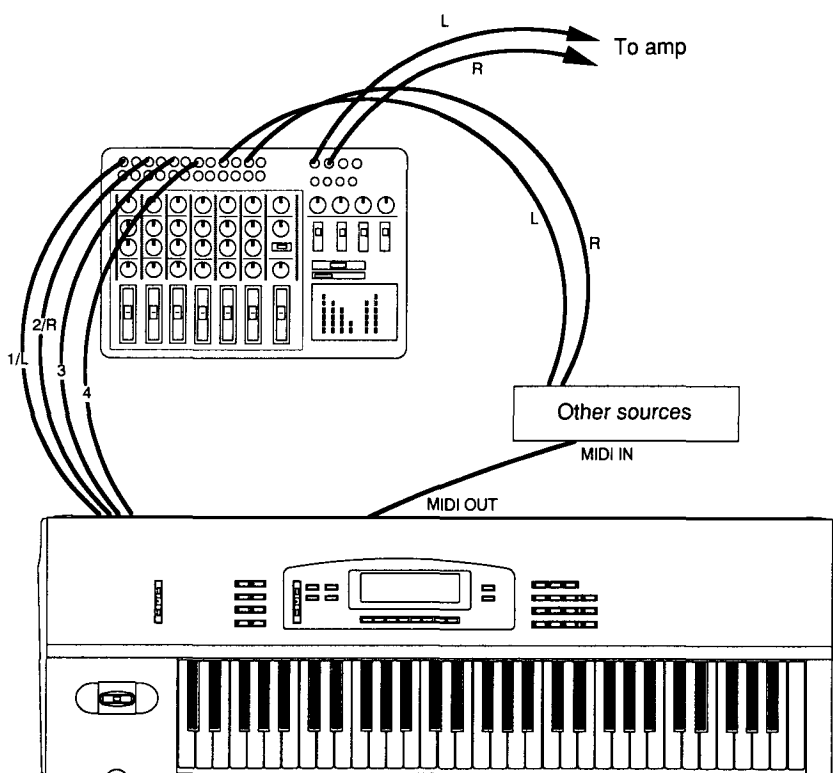

- The 01/WFD•01/W will respond to Note messages transmitted from MIDI IN for all notes C-1 — G9 (notes numbers 0 — 127). (For some Programs, the high range may not sound.)

Key name	C-1	C0	C1	C2	C3	C4	C5	C6	C7	C8	C9	G9
MIDI Note Number	0	12	24	36	48	60	72	84	96	108	120	127



Note:

The 01/WFD•01W does not have a contrast knob. When the unit is shipped, the LCD contrast is set at an appropriate level, but depending on the temperature, etc., this may need to be re-adjusted for best visibility. If necessary, press the GLOBAL key to enter Global mode, and adjust the display contrast (for the first parameters on the first page).

HOW THE 01/WFD•01/W IS ORGANIZED

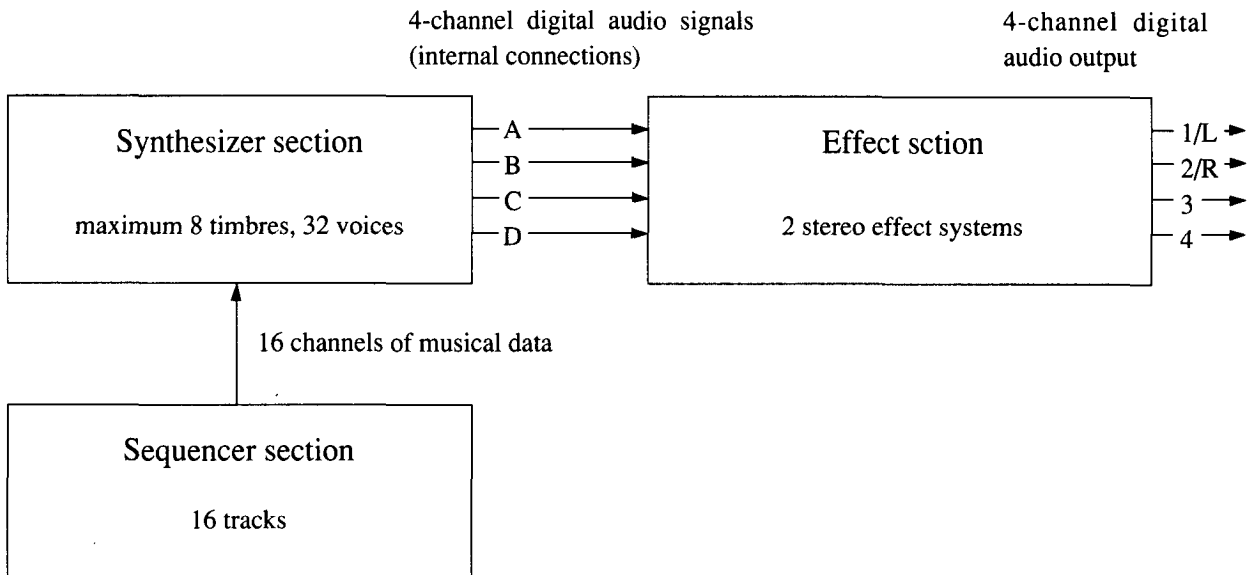

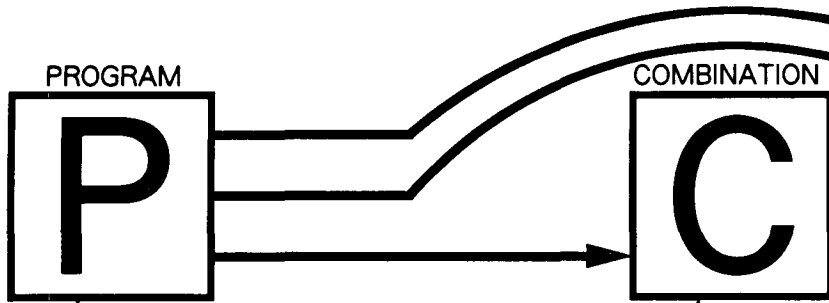

- A Program is defined as a simple synthesized sound.
- Programs can be selected from A00-B99 (internal memory) or C00-D99 (card).

Single Program



Double Program

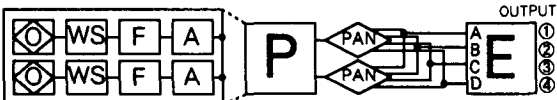

Programs using a Drum Kit

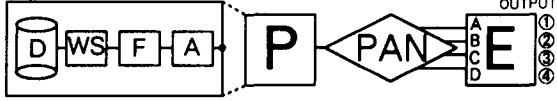

- One of the two Drum Kits from the bank used for the Program is selected.
- It is preferable to use the Drum Kit panpots which have been selected for each Instrument setting in the Drum Kit (Global mode P1, P2).

Settings made thus far are done in the Edit Program mode.

Multisound (Source Waveform)

- The Oscillator permits the selection of 00-254 Multisounds.
- Multisounds can also be selected from a PCM Card.
- Refer to the page on the Edit Program mode for more details. A single sound can be processed by various means to create a Multisound.
- WS (Wave Shaping) is used to change the shape of a waveform.
- VDF (Variable Digital Filter) is used to control the tone.
- VDA (Variable Digital Amplifier) is used to control the volume.
- The processes are carried out in the Edit Program mode.

Drum Kit Instrument Connections

- The drum sound sources are assigned at different positions on the keyboard.
- The instrument connections, including the panpots, are edited in Global mode (P1, P2).

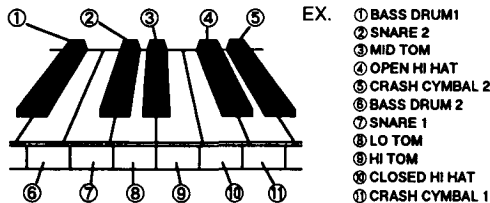

- A Combination is a number of Programs which have been combined. The Programs are entered one at a time via the Timbres (8 of which are provided).
- Effects make use of the settings made for the Combinations; settings made for Programs are ignored.
- Combinations can be selected from A00-B99 (internal memory) or C00-D99 (card).
- During operation in the Combination mode, the Combination is changed when MIDI channel Program changes (made in the Global mode) are received.
- Because the panpots are set for each Timbre, settings made in the Program can also be used.

Sample: A Combination Using Two Programs

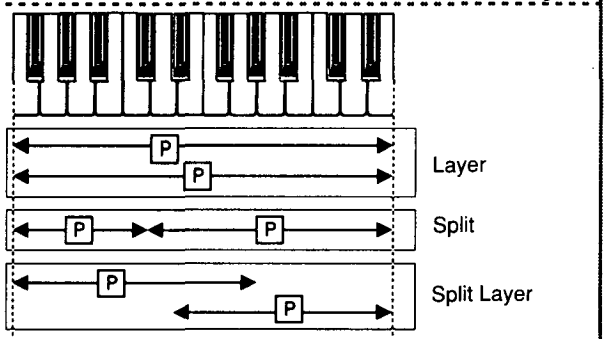
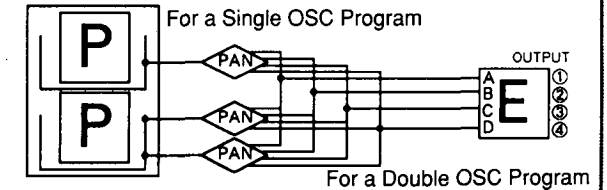

Sample: A Combination Using Multiple Programs

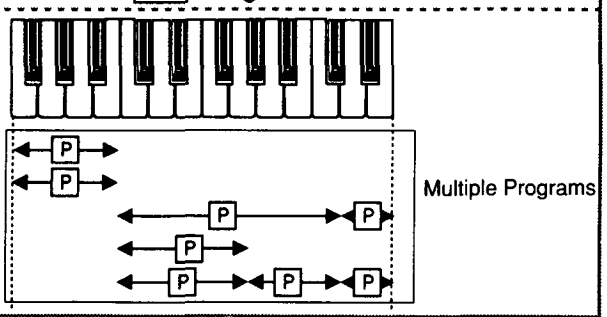
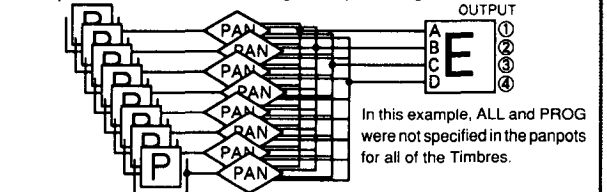

Settings made thus far are done in the Edit Combination mode.

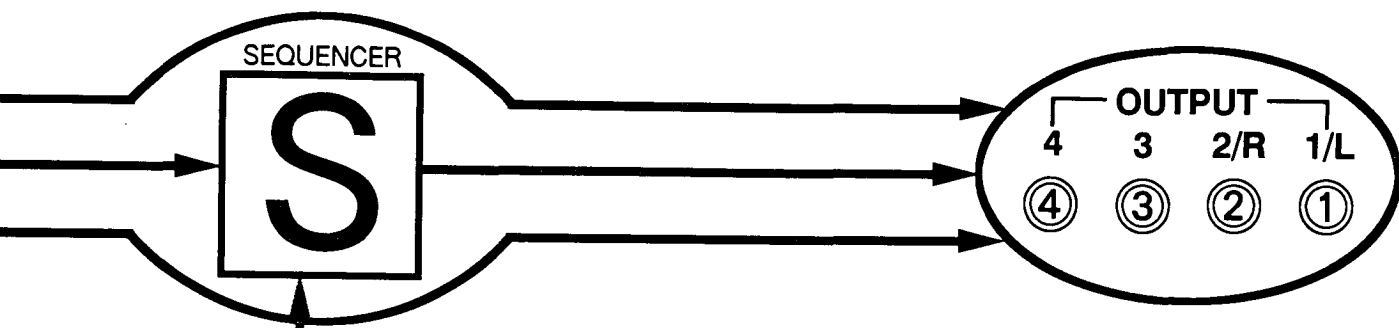

- A Program is assigned to each Track.
- Panpots are set for each Track.
- Effects are set for each song.
- 16 Tracks can be used for each song.
- Rhythm Tracks are created from a combination of patterns. Between 00-99 patterns are made in advance, and are then included in the track.
- Also, a MIDI channel is set for each Track, permitting control of external sound sources.

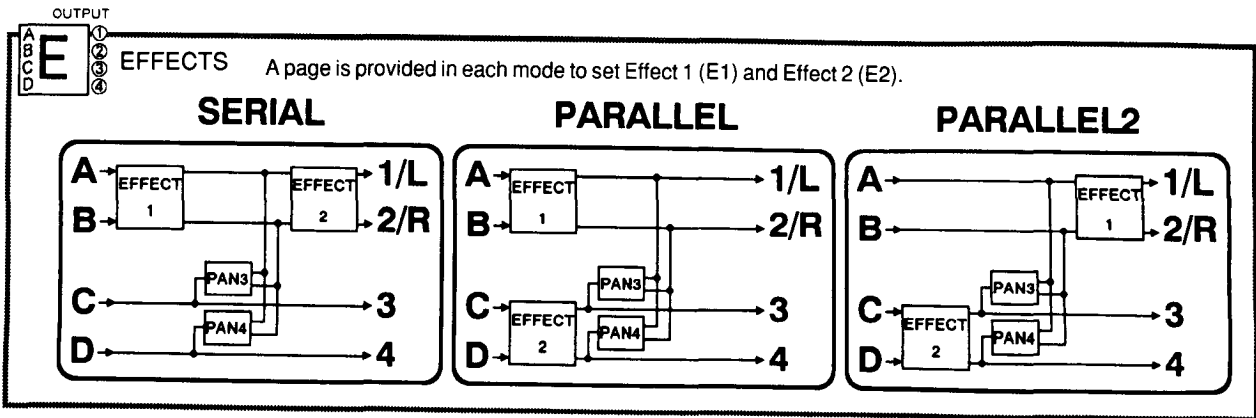
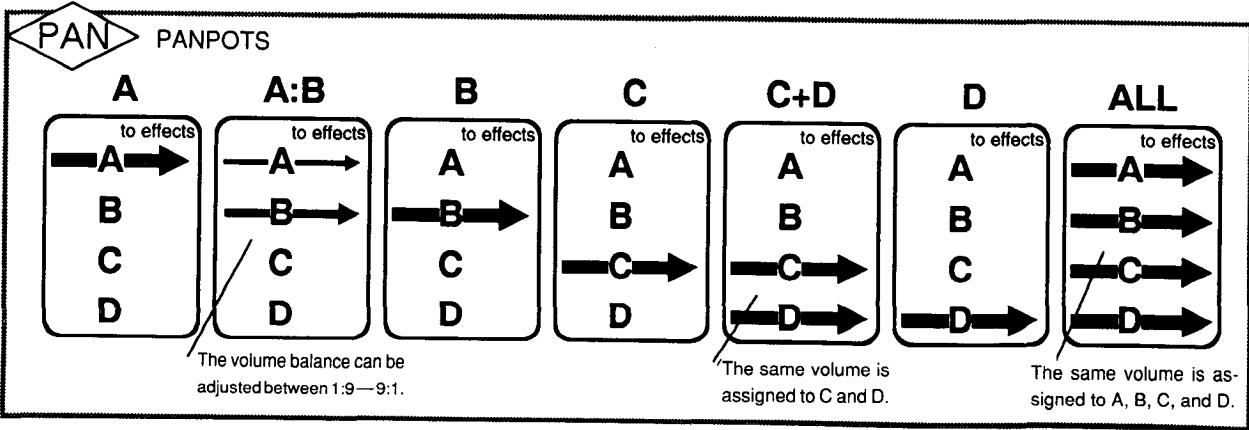
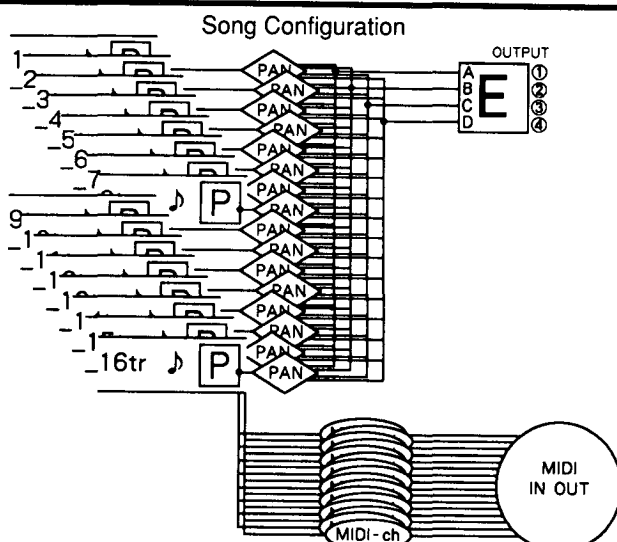

PLAYING A COMBINATION (A COMBINATION OF SEVERAL SOUNDS)

There are 200 combinations in the internal memory (Bank A:00-99, Bank B:00-99) and 200 more are available in the PROG/SEQ card (Bank C:00-99, Bank D:00-99).

- (1) Press the COMBI mode select key (Combination mode).
- (2) Use the BANK key, (INT/CARD key and BANK key for the 01/W), number keys, and ∇ / \triangle keys to select the Combination (A00-B99, C00-D99) you wish to play.
- (3) Play the keyboard and you will hear the Combination you selected in step (2).

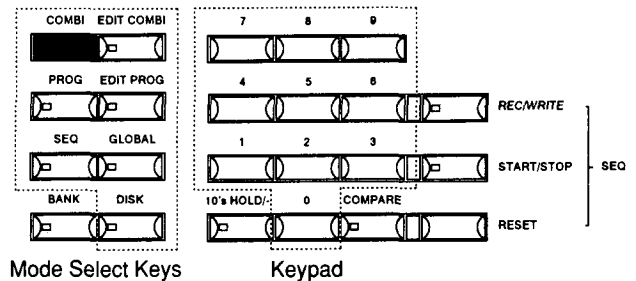

About the display

When you select Combination mode, the display will be as follows. The volume for each timbre (Timbres 1-8 from the left) set by the slider is shown on the display.

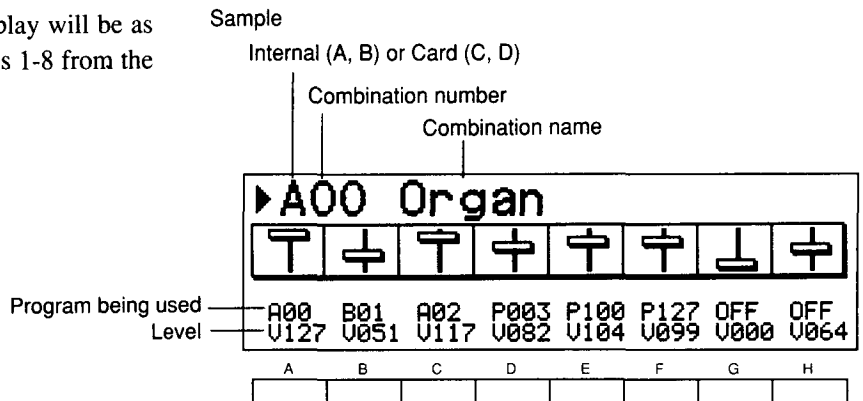

Each display corresponds to the cursor key below it. For example, you can press cursor key \square , and then use the VALUE slider to change the volume of Timbre 4 (volume number "82" in the example).

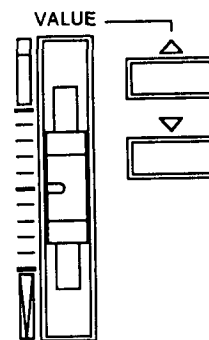

PLAYING A PROGRAM (A SINGLE SOUND)

There are 200 programs in the internal memory (Bank A:00 — 99, Bank B:00 — 99) and 200 more are available in the PROG/SEQ card (Bank C:00 — 99, Bank D:00 — 99).

- (1) Press the PROG mode select key (Program mode).
- (2) Use the BANK key (INT/CARD key and BANK key for the 01/W), number keys, and Δ/∇ keys to select the Program (A00 — B99, C00 — D99) you wish to play.
- (3) Play the keyboard and you will hear the Program you selected in step (2).

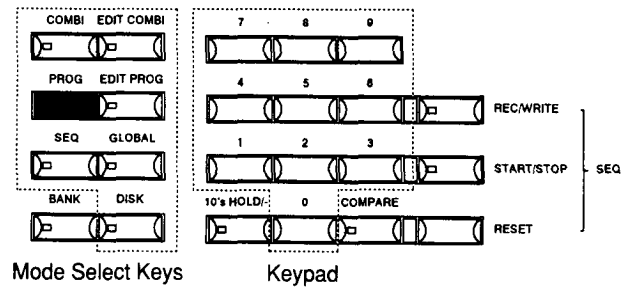

About the display

Example

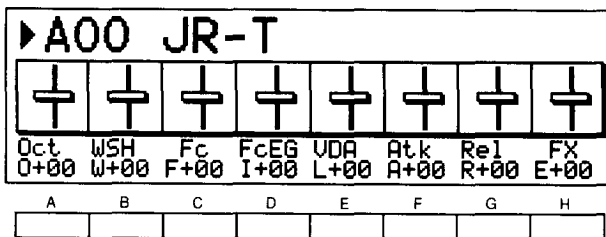

When you select PROGRAM mode, the display will be as shown in the example. Here you can press a cursor key [A] — [H] to display the corresponding parameter name and value, and then use the VALUE slider to adjust the value of the parameter displayed above that key. In this way, you can easily edit a sound without entering Edit Program mode. This is especially convenient during a live performance.

* The various parameters affect the sound as follows. (For a more detailed explanation, refer to "Program mode".)

- O = Octave
This adjusts the octave settings up and down. (-3 — +3)
- W = Wave Shaping Intensity
This adjusts the amount of deformation of the PCM waveform. Higher settings will result in greater deformation. (-10 — +10)
- F = VDF Cutoff (VDF cutoff frequency)
This adjusts the frequency at which the VDF begins to cut. Higher settings will make the sound brighter, and lower settings will make the sound darker. (-10 — +10)
- V = VDF EG Intensity
This adjusts the intensity of VDF EG. (-10 — +10)
- L = VDA Level
This adjusts the overall volume of the Program. (-10 — +10)

A = VDA EG Attack Time

This parameter adjusts the VDA EG attack time of the Program. Higher settings will result in a slower attack.

R = VDF, VDA EG Release Time

This parameter adjusts the release time of the Program. Higher settings will result in a longer release time. (-10 — +10)

E = Dry:Effect Balance

This parameter adjusts the volume balance between effect processed sound and direct sound. As this value is increased, the proportion of the effect processed sound (relative to that of the direct sound) will increase. (-10 — +10)



Note:

The parameters you edit here will return to their original values when you select another Program. If you move to another mode after adjusting them in PROGRAM mode, the corresponding Program parameter (two or more in some cases) will be modified (your edits will be remembered), and when you return to PROG mode these values will be displayed once again as 00. The sound remains as edited. You may save the sound by using the REC/WRITE key.

HOW TO USE THE SEQUENCER

The floppy disk included with the 01/WFD contains demo song data. Follow the procedure beginning with step (1).

The 01/W is shipped with demo song data in memory, so use the following procedure beginning with step (6).

Here's how to hear the demo songs.

- (1) Insert the floppy disk containing the demo song data into the disk drive.
- (2) Press the DISK mode select key. (The disk mode Load Disk page will appear.)
- (3) Use the cursor UP/DOWN keys to move the cursor (the inverse area) to "Load All Data".
- (4) Use the Δ / ∇ keys to select the file to be loaded.
- (5) Press **[G]** [Load], and you will be asked "YES/NO". Press **[F]** [YES], and the data will be loaded from disk into internal memory.
- (6) Press the START/STOP key to enter the Sequencer mode, and the sequencer will begin playback.
- (7) Press the START/STOP key once again, and playback will stop.

- (8) While holding the RESET key, press the START/STOP key and playback will begin from the beginning of the song. If you press the START/STOP key without holding the RESET key, playback will continue from the location where you stopped.

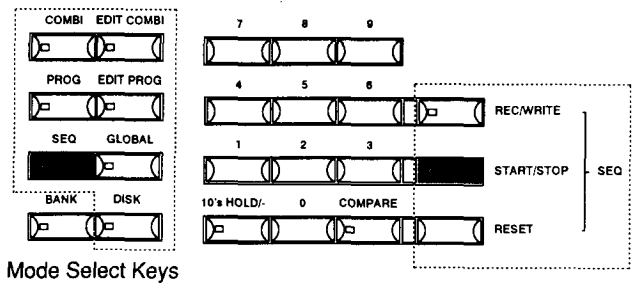

SONG0		SnowGoose				Tempo	
*A00	A01	A02	A03	A04	A05	A06	A07
PLAY	PLAY	PLAY	PLAY				
A08	A09	A10	A11	A12	A13	A14	OFF
SNG0 Tr:01		M001	4/4	OVWR			
Q:144:MAN		Q:HI	M:OFF	Edit:PRG			
A	B	C	D	E	F	G	H

HOW TO RECORD

Now let's try recording into the sequencer.

- (1) Press the SEQ mode select key to enter Sequencer mode.
- (2) Press the numeric key 0 to call up Page 0, which will enable you to select a song.
- (3) Use the VALUE slider to select the song you wish to record. For this example, select "9".
- (4) Press cursor key **[B]**, and then use the VALUE slider to select the track you wish to record. For this example, select "1".
- (5) Press cursor key **[F]**, then press the DOWN key to display "PROG", and then move the cursor to Track 1. (To do this, press the UP key twice, and then press cursor key **[A]**.) Use the value slider to select the Program you wish to use.) Select any Program you like.
- (6) Press the REC/WRITE key.
- (7) Press the START/STOP key. Recording will begin. After the two-measure count, begin playing.
- (8) When you finish playing, press the START/STOP key once again, to end recording.
- (9) Press the START/STOP key once again, and the performance you just recorded will be played back.

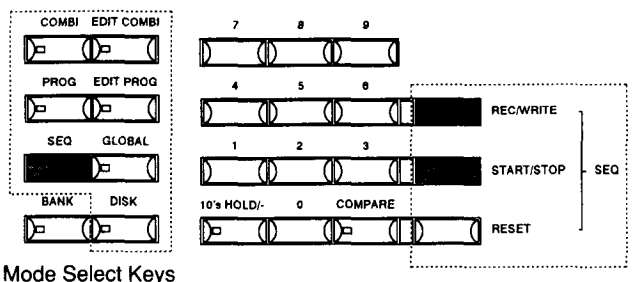

SONG9		New Song9				98% Free	
A53	*A00	*A00	*A00	*A00	*A00	*A00	*A00
REC							
*A00	*A00	*A00	*A00	*A00	*A00	*A00	*A00
SNG9 Tr:01		M001	4/4	LOOP			
J=120:MAN		Q:HI	M:OFF	Edit:PRG			
A	B	C	D	E	F	G	H

KEY AND SLIDER FUNCTIONS

Number keys

- In Combination mode, use these keys to select Combinations.
- In Program mode, use these keys to select Programs.
- In other modes, use these keys to select the page of the function (The page number is displayed in the top line of each page.). You can also enter the number, by using these 10's keys while holding down the Cursor key (**[A]**—**[H]**). See "How to input data", p.16 for details.

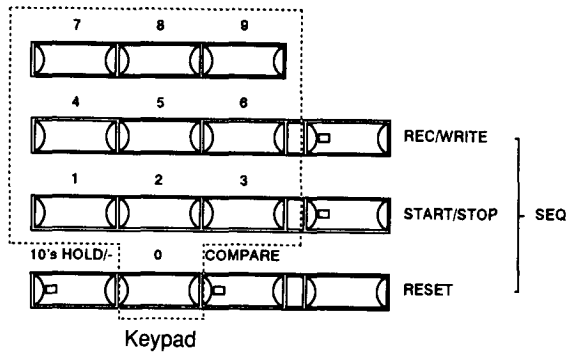

10's HOLD - key

In Program or Combination mode, you can use the 10's HOLD/- key to fix the ten's digit of the number, so that only the one's place will change. For example if you have selected "21", and you press the 10's HOLD/- key, the ten's digit "2" will be fixed, and you can then press "7" to select "27", or press "3" to select "23". (This is referred to as the 10's HOLD.) To cancel this, press the 10's HOLD/- key once again. (The key indicator will light when bank hold is on.)

- If you use the ∇ / \triangle keys, the foot switch, or MIDI program change messages to change the Combination or Program, 10's HOLD will be cancelled.
- In Program mode and Combination mode, pressing the number key while holding down the 10's HOLD/- key will show ten Programs or Combinations, the ten's digit of which is the same as the number of the key pressed (see illustration at right).
- When using the number keys to enter data, this key is also used to enter the negative value and to select a Multisound from a PCM card.

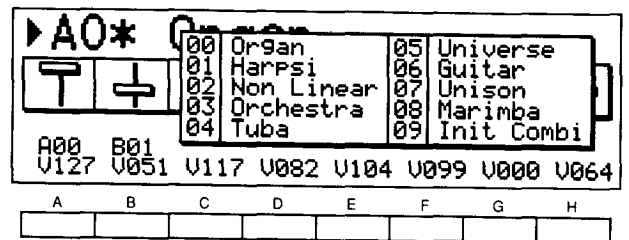
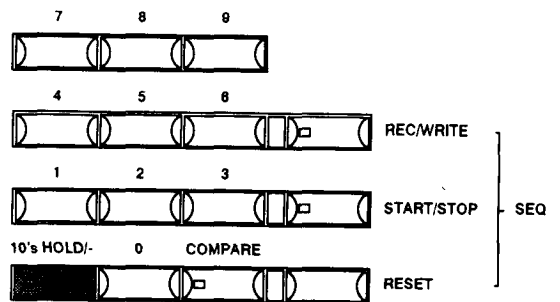

COMPARE key

In Edit Program mode and Edit Combination mode, this key allows you to temporarily restore the values of all parameters used for a Program or Combination to the settings it had before you began editing. Press the COMPARE key once again, and the settings will be restored to the values you edited. However if you edit a Program or Combination while comparing, your previous edits will be lost. (The key indicator will light while compare is on.)

Also, if the COMPARE key is pressed while in PROGRAM mode or COMBINATION mode, the edit recall function will call up values last set in EDIT PROGRAM mode or EDIT COMBINATION modes respectively.

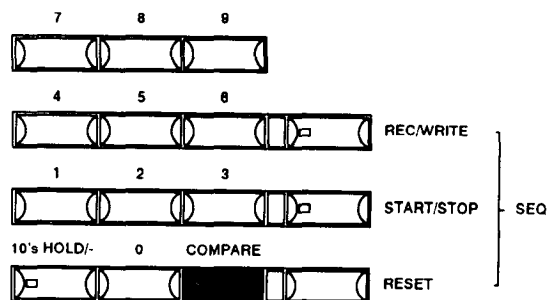

Mode Select Keys

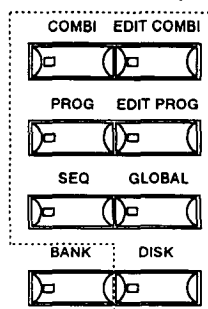

Mode Select Keys

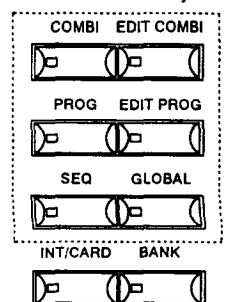

Mode select keys

The lit key indicates the current mode.

BANK (01/WFD) key

Use this key to select Combinations, Programs or songs from internal memory (Banks A, B) or from a PROG/SEQ card. (The indicator will light when Card is selected.)

The bank selected will change with each press of the key (A → B → C → D → A → B...). For a song, each press of the key will change the selection as follows: I (Internal) → C → D → I.

INT/CARD key, BANK key (01/W)

Press the INT/CARD key to switch between selecting Combinations or Programs from internal memory or from a card. Pressing the BANK key will switch between internal banks A and B or card banks C and D.

- PCM (Multisound) card waveforms are selected in the Edit Program mode parameter Oscillator Assign, or in the Global mode drum kit parameters. (This CARD key is not used.)
- The contents of a PROG/SEQ card are organized into 2 banks (C, D).
- Card sequencer song data can be used directly only when playing. When editing or recording, you must first use the Global mode functions to load it into internal memory. Be aware that loading sequencer data from card will overwrite all sequencer data that was previously in internal memory.
- Be sure that cards are inserted firmly into the correct slot.

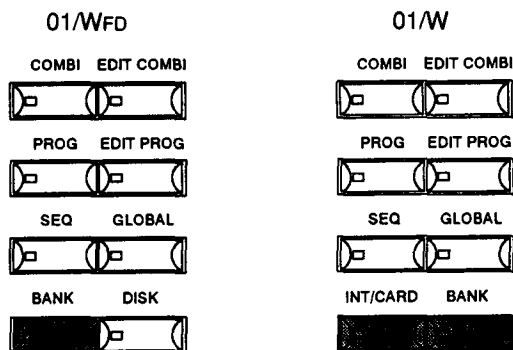

Cursor UP/DOWN keys, cursor [A] — [H] keys, VALUE slider

After using the cursor UP/DOWN keys to select the line of parameters you wish to edit, press the [A] — [H] key below the desired parameter. Then use the value slider to modify the value of that parameter. To execute a function enclosed in [] in the display, press the key below it.

- You can perform various functions by pressing another key while holding a key [A] — [H]. (See "How to input data", p.16.)

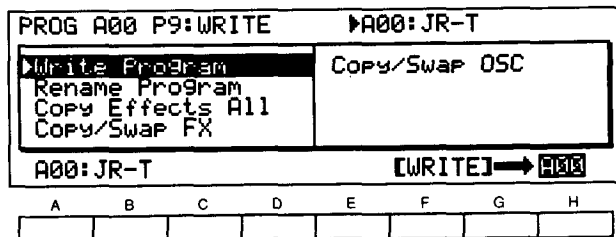
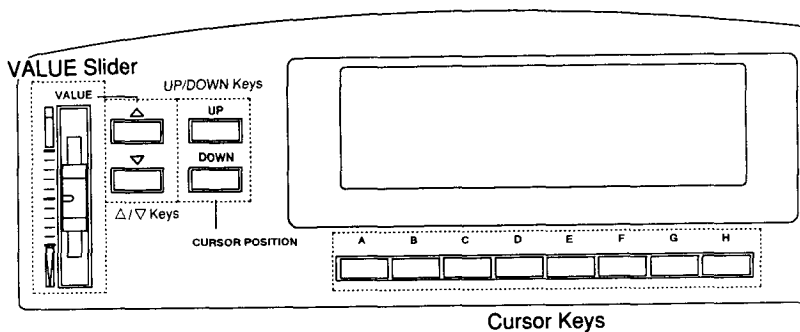

VALUE Δ / ∇ keys

Use these keys to specify a precise value for a parameter that may be difficult to set using the value slider. To increase the value by 1, press Δ. To decrease the value by 1, press ∇. If you continue holding the switch, the value will change continuously. By simultaneously pressing Δ and ∇, you can undo the modification (i.e., restore the value of the parameter when you selected it).



Press the COMBI/PROG mode select key (or immediately after you have entered Combi/Prog mode), and the cursor “►” will be displayed on the left of the Combination/Program number in the upper left of the display. If you now press the \triangle key, the next Combination/Program will be selected. (If you press the ∇ key, the previous Combination/Program will be selected.)

- In this case, moving the value slider will not change the Combination/Program. Depending on the effect settings of the selected Combination/Program, you will be able to control the effect as well.
- Press a cursor key (\boxed{A} — \boxed{H}) and the cursor will move to the corresponding parameter, allowing you to use the \triangle/∇ keys and value slider to edit. (This is known as the “performance edit” function.)

PAGE+/- keys

The various functions of the 01/WFD•01/W are organized into display pages. Use these keys to advance to the next page (PAGE+) or return to the previous page (PAGE-).

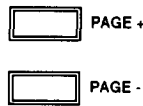

START/STOP key

This key is used to start and stop the sequencer. During playback, the indicator will blink red on the first beat, and green on the other beats.

REC/WRITE key

This key is used to record in SEQ mode. When the REC/WRITE key is lit, pressing the START/STOP key will begin recording. To cancel recording, press the REC/WRITE key once again without pressing START/STOP. (The indicator will be lit when recording is on.)

When in Combi, Edit Combi, Prog, or Edit Prog mode, press the REC/WRITE key to write that Combination or Program.

RESET key

Pressing the START/STOP key in SEQ mode will stop playback, and pressing the RESET key will restore the song position to the beginning of the song (When you have used the Next Song function for continuous playback, this will be the beginning of the song from which playback began.). When you then press the START/STOP key, playback will start from the beginning of the song, and the Program number, volume, etc. of the starting position will be used.

- If you press the START/STOP key without pressing this key, playback will begin from the location where you last stopped (i.e., continue start).
- When the 01/WFD•01/W is being played by the sequencer or from MIDI IN, and for some reason a stuck note occurs, you can press the COMPARE key to turn off the sounding notes. (This can be used in any mode.)

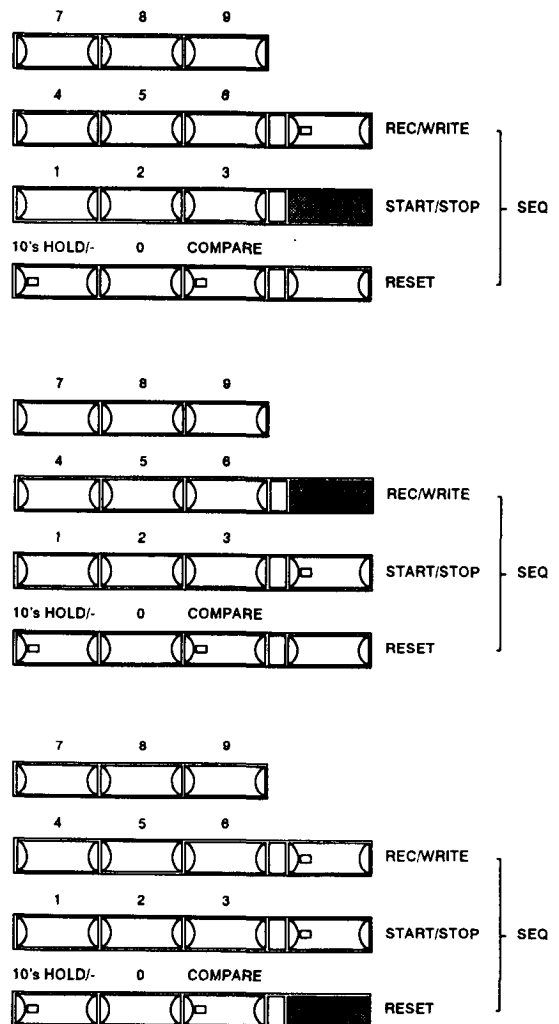

HOW TO CREATE YOUR OWN SOUNDS

This section will explain the process of creating your own sounds on the 01/WFD•01/W.

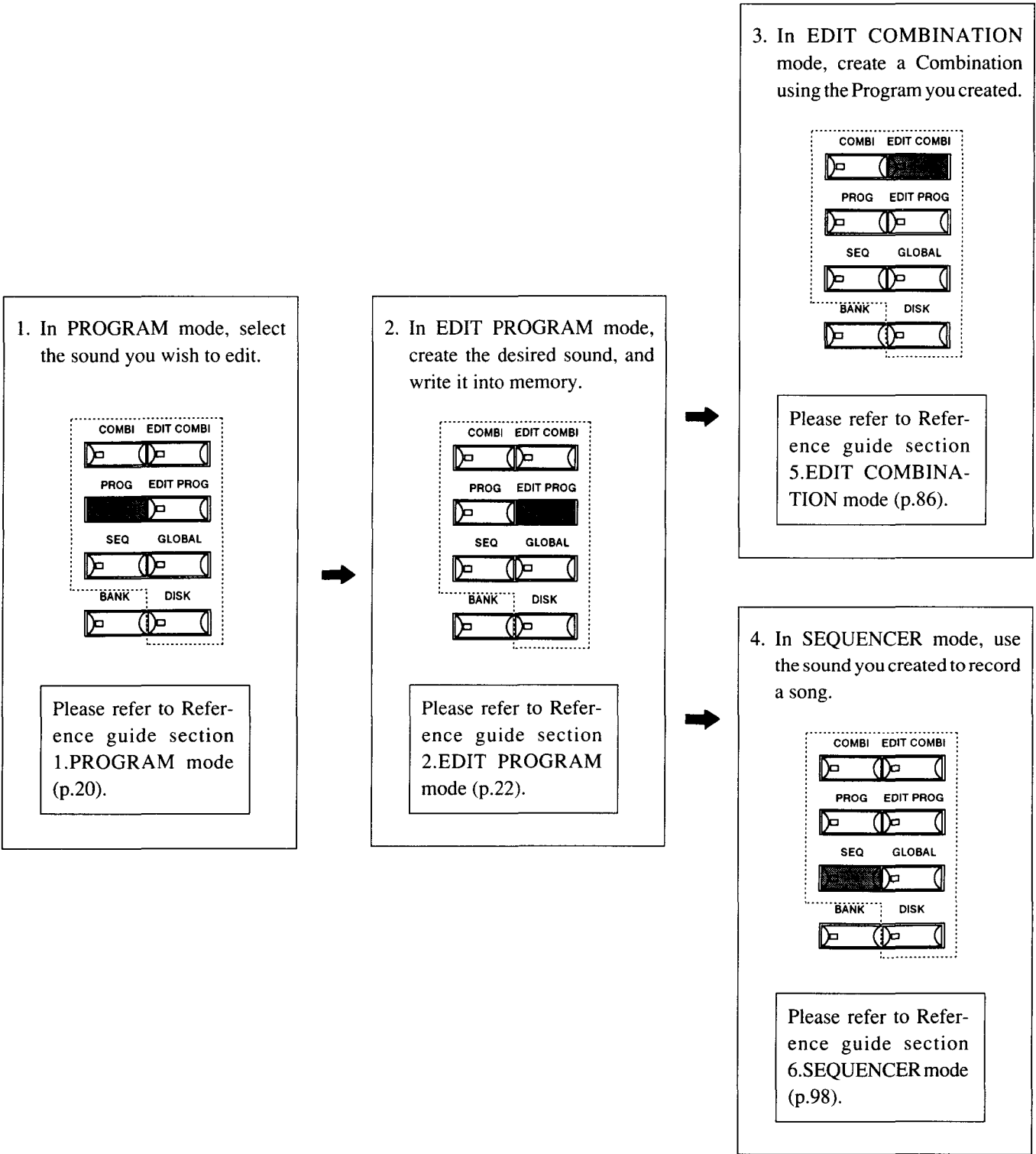

ABOUT THE 01/WFD•01/W'S MEMORY

For details, refer to "01/W memory configuration", at the end of this manual.

- Any bank may be used when selecting a Combination in the Combination mode.
- Any bank may be used when selecting a Program in the Program mode.
- When selecting a Program which makes use of all Timbres in the Edit Combination Mode, Programs to be used in Combinations from Banks A and B (internal memory) must be selected from Banks A and B as well. Programs to be used in Combinations from Banks C and D must also be selected from Banks C and D. In other words, the Program and the Combination must be selected from the same banks in the internal memory (or Card).
- Drum Kits must be selected from the same Bank as the Program. For example, when selecting a Drum Kit for a Program from Bank C, the selection must be made from Bank C.

Also, a Drum Kit used in editing in Global mode must be taken from the bank currently selected for the Program in Program mode. For example, when you would like to edit a Drum Kit from Bank A, first select a Program (one which has the Drum Kit you wish to edit) from Bank A in the Program mode.

- The data contained in Bank A is used as the Global data. Because of this, when Global data is loaded from a Card (Load Combi/Prog), the Global settings will be changed when loading to Bank A, but the settings will not be changed when loading to Bank B. In addition, even when data being saved to a Card (Save Combi/Prog) is from Bank B, the Global data from Bank A will be saved as well.
- Because Sequence Data is lost from the internal memory when the power is turned off, be sure to save data you wish to keep to a disk or card (01WFD) before cutting the power. For the 01/W (no FD), data will be saved even if the power is turned off. Sequence Data can only be loaded directly from a Card when playing. You must first load the data into the internal memory before doing any editing or recording, and the data must then be saved to a Card when finished.

<< Internal memory >>

01/WFD	<BANK A> 100 Combinations, 100 Programs, 2 Drum Kits, 1 Global Data	<BANK B> 100 Combinations, 100 Programs, 2 Drum Kits	Sequencer Data (10 songs, 100 patterns, up to 48,000 steps)	Sequence data will be lost when the power is turned off. If you wish to keep the data, save it to disk or card before turning the power off.
01/W	<BANK A> 100 Combinations, 100 Programs, 2 Drum Kits, 1 Global Data	<BANK B> 100 Combinations, 100 Programs, 2 Drum Kits	Sequencer Data (10 songs, 100 patterns, up to 7,000 steps)	This data is preserved even when the power is turned off.

<< PROG/SEQ data cards >>

The data in a PROG/SEQ card (512 Kbit RAM card) is organized in two BANKs (C, D), and each BANK can contain either of the following two types of data.

100 Combinations,
100 Programs,
1 Global Data,
2 Drum Kits

or

Sequence data 10 Songs,
 100 patterns,
(up to a maximum of 7,000 steps
total)

☆ PCM cards are of a different type

☆ The following table shows the modes that allow you to write data into a card and read data from a card.

	Read	Write
100 program, 100 combinations, 2 drum kits, 1 global data	Global mode P5-1	Global mode P6-1
All sequence datas (10 songs, 100 patterns)	Global mode P5-2	Global mode P6-2
1 Combination	Combi mode	Edit Combi mode P9-1
1 Program	Prog mode	Edit Prog mode P9-1
1 Drum Kit	Edit Prog mode	Global mode P1,2

Note : When using a new card, first save the data for each bank using the Global mode settings P6-1 and P6-20. Saving the data will format the banks, and allow you to load data, read a Program from the card, and write a Program onto the card.

e.x. Saving the data of both BANKs C and D in Global mode P6-1 (100 programs, 100 combinations) will format both banks for programs and combinations.

HOW TO INPUT DATA

There are various ways to input data into the 01/WFD•01/W.

- Use the VALUE slider, or the ▽ / △ keys (See “Key and slider functions”).
- “Numeric key input” using the numeric keys (0—9) and the 10’s HOLD/- key while holding one of the [A] — [H] keys.
- “Keyboard input” by playing a note while holding one of the [A] — [H] keys.

• Numeric key input

This method is convenient when selecting a Program for use in a Combination, when selecting a Multisound, or when inputting a specific number.

- (1) Select the parameter you wish to edit.
- (2) Press the key ([A] — [H]) that is displayed below the parameter. (Continue pressing the key until step (4).)
- (3) Use the numeric keys (0 — 9) to input the desired value. To input a negative (–) value, press the 10’s HOLD/- key. (This key is also used when selecting a Bank for use by a Timbre in a Combination.)
- (4) When you release the key you pressed in step (2), the value will be entered.

* In general, the numeric value you specified will be the same as the displayed value, but some parameters (Octave, MG Waveform, etc.) are an exception. If the specified value is outside the valid range for that parameter, the parameter will be set to the nearest valid value. (For example if you enter a number of 20 for a parameter that has a range of –12 — +12, it will be given a value of +12.)

• Keyboard input

This method is convenient when specifying the area of a key window, or when selecting a key of a Drum Kit using note name parameters. The procedure is essentially the same as for numeric key input, but you will use the keyboard after steps 1 and 2, instead of using the numeric keys.

The keyboard of the 01/WFD•01/W allows you to specify notes in the range of C2 — C7 (or you can use the Global mode parameter Key Transpose to cover any five-octave range in the area of C1 — C8), but you can also use MIDI to specify a note (in this case, any note C-1 — G9: MIDI note number 0 — 127).

- The numeric keys cannot be used to enter parameters for keyboard input.

• Returning input values to unedited values

If the COMPARE key is pressed during the editing of a Program or Combination, the values for all parameters will return to the value they had when the Program or Combination was selected, and the COMPARE key’s LED will light up. Pressing this key a second time will change the values back to those set during editing, and the LED will go out.

THE DISK DRIVE AND FLOPPY DISKS

The 01/WFD contains a disk drive. Please observe the following precautions.

Disk drive

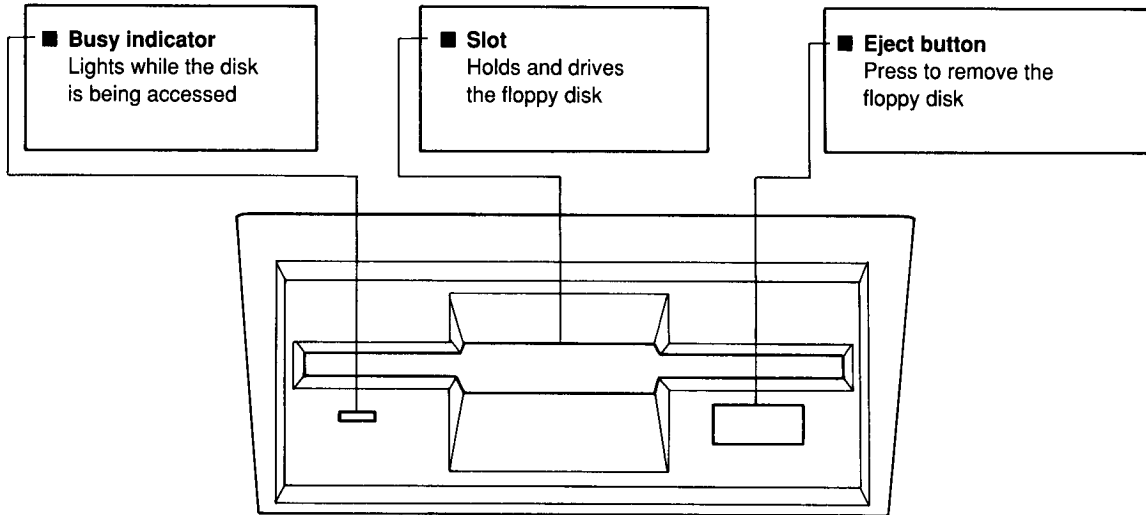

■ Inserting a floppy disk

Insert the floppy disk into the drive with the label facing upward. Push the disk into the drive until it clicks into place.

* Floppy disks should be inserted carefully, and pointing straight into the slot.

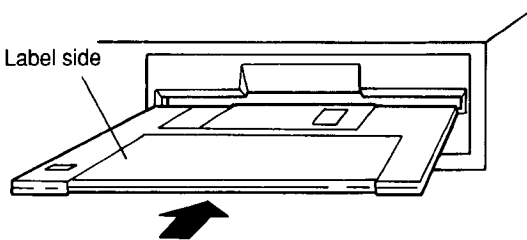

■ Removing a floppy disk

(1) Make sure that the busy indicator is not lit.

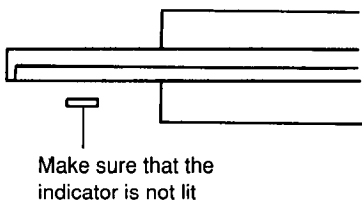

(2) Press the eject button, and remove the disk.

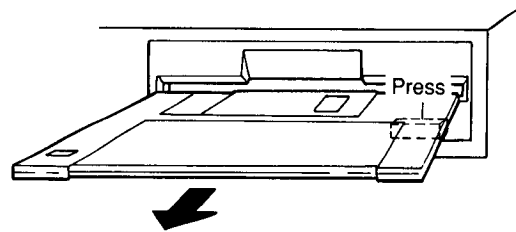

■ Precautions for the disk drive

* The busy indicator will light when the disk is being accessed (read or written). Never remove the disk or turn off the power when this indicator is lit. Doing so may damage the disk or the data on the disk.

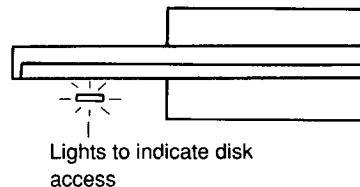

■ Head cleaning

- If the disk drive head becomes dirty, data errors may occur. Accumulated dirt can scratch the disk. Regular cleaning is important to avoid dirt buildup.
- To clean the disk drive head, use a commercially available fluid-type head cleaning disk for dual-sided drives. Using a single-sided cleaning disk may damage the disk drive.

• Cleaning procedure

- (1) Moisten the cleaning disk with cleaning liquid.
- (2) Immediately insert the cleaning disk into the disk drive, and execute a load operation. (Any type of load operation is ok.) An error message will appear.
- (3) After approximately 10 seconds, press the eject button, and remove the cleaning disk.
- (4) For approximately 5 minutes, do not use the disk drive. (Using the disk drive before the cleaning liquid has dried may cause malfunctions.)

Floppy disks

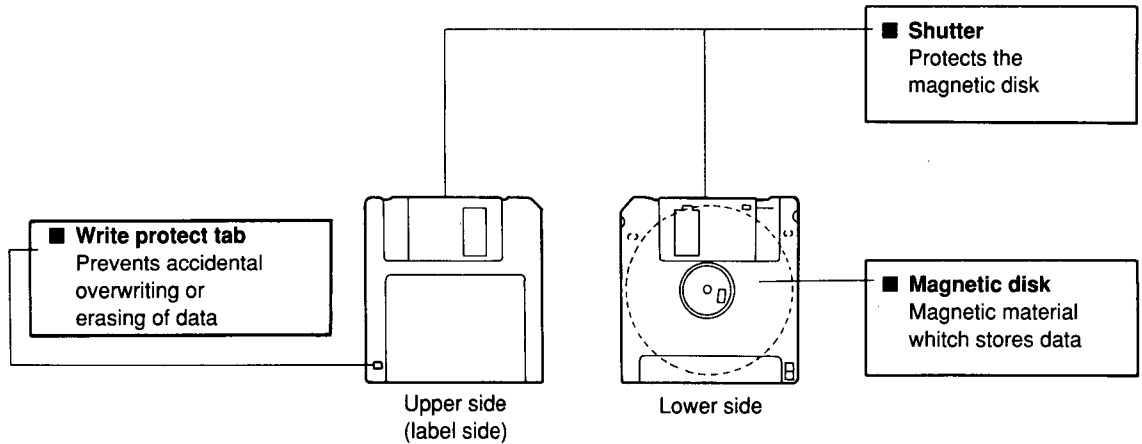

■ Floppy disk handling

- Avoid using or storing floppy disks in locations of high temperature, high humidity, in direct sunlight, or in excessively dirty or dusty locations.
- Do not open the shutter. Doing so may cause the disk to become dirty or scratched.
- Do not allow floppy disks to be brought near magnets, televisions, speakers, or power transformers. If a disk is exposed to a strong magnetic field, its data may disappear.
- Never transport the 01/WFD•01/W with a floppy disk inserted in the drive. Vibration may cause the disk drive heads to scratch the disk, making it unusable.
- Do not place objects on top of a floppy disk. Doing so can deform the disk, making it unusable.

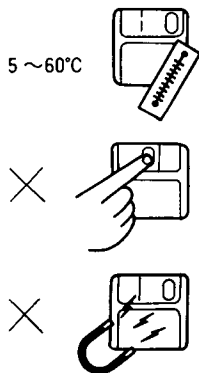

■ The write protect tab

The small sliding “Write protect tab” at the corner of a floppy disk allows you to prevent important data from being accidentally overwritten.

- ★ When the tab is covering the hole, data can be written onto the disk.
- ★ When the tab is uncovering the hole, data cannot be written onto the disk.
- ★ Write prohibit

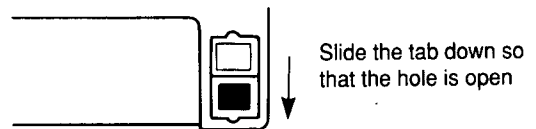

- ★ Write permit



Note:

After you save important data, set the write protect tab to the “Protect” position (the hole is open) so that you will not accidentally erase the data. (Slide the tab until it clicks into position.)

APPLICATION SECTION

HOW TO READ A DISPLAY PAGE CHART

P0-6 Pitch EG (pitch EG) ————— ①

A	S	Start Level	-99 — +99	Specify how the pitch of OSC1 will change over time. ②
B	AT	Attack Time	0 — 99	
C	A	Attack Level	-99 — +99	
D	DT	Decay Time	0 — 99	
E	RT	Release Time	0 — 99	
F	R	Release Level	-99 — +99	
G	L	EG Level Vel. Sens	-99 — +99	Specify how key velocity will affect the depth of the pitch EG.
H	T	EG Time Vel. Sens	-99 — +99	Specify how key velocity will affect the speed of the pitch EG.

(1) P0-6 PITCH EG (pitch EG): This indicates that this display is for the sixth line of page 0, and contains pitch EG parameters.

(2) Diagrams relating to this page

(3) Cursor position keys to move to this parameter.

(4) Parameter name

(5) Value range (numerical values, etc.) and contents of this parameter (The value written farthest to the left in this panel appears when the VALUE slider is in the lowest position.)

(6) Explanation of the function of the parameter

* In this manual, "cursor" refers to the parameter displayed in inverse video.

1. PROGRAM MODE

In this mode you can select and play Programs (sounds) from memory. You can select internal Programs A00 — B99, and card Programs C00 — D99.

To select Programs, use the BANK key, the INT/CARD key (01/W only), the numeric keys (0 — 9), Δ key and ∇ key, a foot switch (PROG UP/DOWN), or MIDI program change messages.

- If you wish to use a footswitch to select programs, set the Global mode Assignable Pedal parameter to “Program Up” or “Program Down” (see p. 165).
- “▶ FX1” or “▶ FX2” will be displayed to the right of the program name in situations for which the VALUE slider can be used to control the dynamic modulation of an effect.
- If you wish to use MIDI to select programs, set the Global mode MIDI Filter PROG parameter to “ENA” (see p. 159).
- Before selecting a Card Program, insert a PROG/SEQ card containing Program data.

- Pressing the COMPARE key while in PROGRAM mode will enable the edit recall function to call up values last set in EDIT PROGRAM mode.

Example:

After creating a piano sound in the EDIT PROGRAM mode and then moving to the PROGRAM mode, although a different program number may be selected, pressing the COMPARE key will leave the new program number as it is and bring up the piano sound from before.

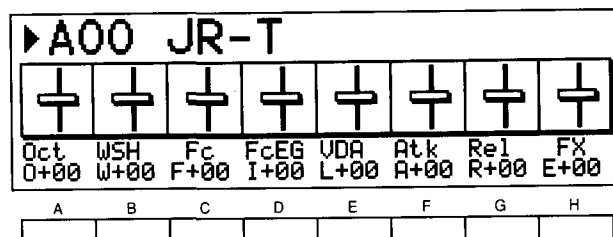

EDITING WHILE IN PROGRAM MODE ("PERFORMANCE EDITING")

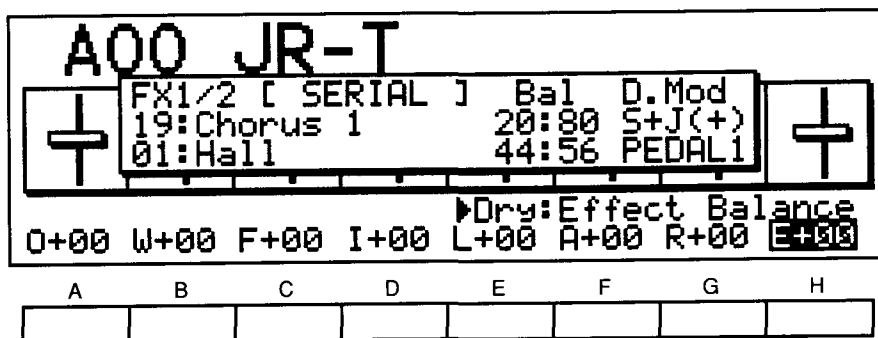

[A] O	Octave	-3 — +3	Change the OSC1 and OSC2 octaves
[B] W	Wave Shaping	-10 — +10	Adjust the EG level (adjust the deformation of the PCM waveform)
[C] F	VDF Cutoff	-10 — +10	Adjust the cutoff frequency of VDF1 and VDF2 (adjusts the tone)
[D] I	VDF EG Intensity	-10 — +10	Adjust the EG intensity of VDF 1 and 2 (how changes in time will affect tone)
[E] L	VDA Level	-10 — +10	Adjust the level of OSC1 and OSC2 (adjusts the volume)
[F] A	Attack Time	-10 — +10	Adjust the attack time of VDA1 and VDA2 (how quickly the sound will begin)
[G] R	Release Time	-10 — +10	Adjust the release time of VDF1, 2 and VDA1, 2
[H] E	Dry:Effect Balance	-10 — +10	Adjust the balance of direct and processed sound for Effect 1, 2

- You can edit major program parameters in Program mode, by holding a cursor position key (**A**—**H**) and using the value slider and the Δ / ∇ keys. This can be especially useful during a live performance.
- Editing these program settings will automatically affect the corresponding Edit Program parameters shown on the display (see the following page).
- After using these editing operations, you can write your edits into memory using the REC/WRITE key or in Edit Program mode page 9.
- To return from editing to the previous display, press the CURSOR UP key.

HOW PERFORMANCE EDITING AFFECTS EDIT PROGRAM PARAMETERS

When you are performance editing, adjusting the various performance edit parameters in the “+” direction will affect the Edit Program parameters as follows. (Changes in the “-” direction will have the opposite effect.)

Changes made in Program mode (“performance editing”)	Result of editing in the “+” direction	
Octave	OSC 1, 2 Octave	Adjusted in higher octave
Wave Shaping	Wave Shaping 1, 2, Start Level Wave Shaping 1, 2 Sustain Level	Adjusted in the “+” direction (*1)
VDF Cutoff	VDF1, 2 Cutoff	Adjusted in the “+” direction (*1)
VDF EG Intensity	VDF 1, 2 EG Intensity	Adjusted in the “+” direction (*2)
VDA Level	OSC1, 2 Level	Adjusted in the “+” direction (*1)
Attack Time	VDA1, 2 Attack Time	Adjusted in the “+” direction (*1)
Release Time	VDF1, 2 Release Time VDA1, 2 Release Time	Adjusted in the “+” direction (*1)
Dry:Effect Balance	Effect 1, 2 Balance	Adjusted in the “+” direction (*1)

(*1) Five times the value will be added to the value. For negative (-) values, five times the value will be subtracted from the value. [Value = Value \pm 5xV]

(*2) Three times the value will be added to the value. For negative (-) values, three times the value will be subtracted from the value. [Value = Value \pm 3xV]

- The resulting values are limited to the range of each parameter.

2. EDIT PROGRAM MODE

This mode is where you edit Program parameters, such as EG settings and the selection of a waveform.

- To edit a Program, you must first select it in Program mode.
- You can also edit Programs while in Program mode (“Performance editing”).
- When you finish editing, use page 9 to write your edits into memory. You can also write your edits into memory by pressing the REC/WRITE key. (If you select another Program before doing so, your edits will be lost.)

- While editing, you can press COMPARE to listen to the original un-edited Program. If you press COMPARE again without editing, you will return to the Program being edited.

* In EDIT PROGRAM mode, the numeric keys select pages, but you can also use them in conjunction with the cursor keys **[A]** — **[H]** for numeric input.

HOW THE PROGRAM PARAMETERS OF THE 01/WFD 01/W ARE ORGANIZED

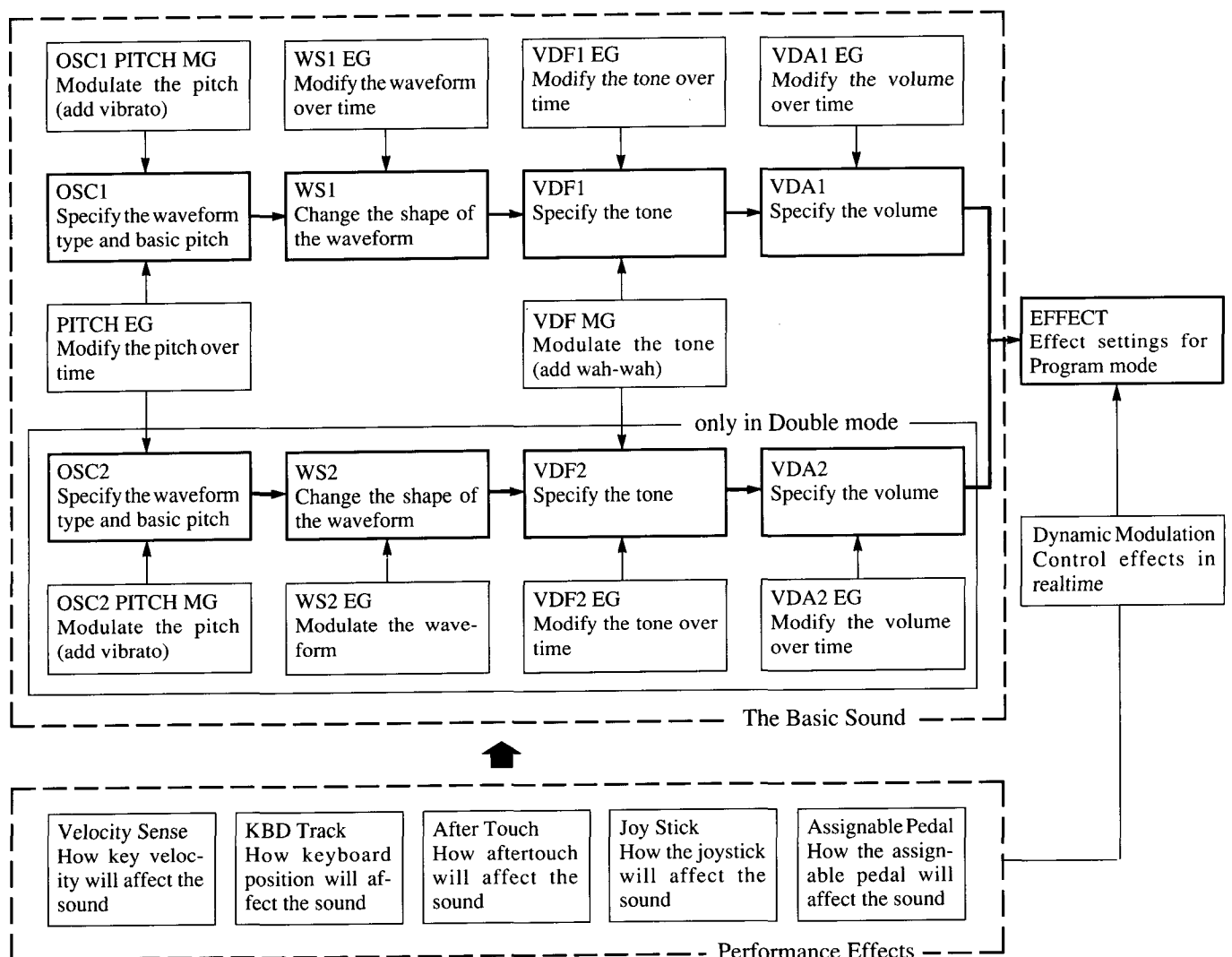

FUNCTIONS IN EDIT PROGRAM MODE

- Press a numeric key (0 — 9) to select the page of each function.

Use the ▽ / △ keys to select the page that contains the item you wish to edit, and use the cursor keys ([A] — [H]) to select the parameter.

Page	Function	Parameters
P0 OSC	0 - 1 OSC Mode 0 - 2 Assign, Hold 0 - 3 OSC1 Multisound, Level 0 - 4 OSC2 Multisound, Level 0 - 5 OSC2 Interval, Detune 0 - 6 Pitch EG	Oscillator mode Number of voices to sound, and Hold settings Oscillator 1 waveform and level Oscillator 2 waveform and level Double mode only Difference in oscillator 2 relative to oscillator 1 Double mode only Change in pitch over time
P1 Emphasis, WS	1 - 1 Emphasis 1 1 - 2 Emphasis 2 1 - 3 Wave Shaping 1 1 - 4 Wave Shaping 2	Add brilliance to oscillator 1 Add brilliance to oscillator 2 Double mode only Adjust the waveform modification for oscillator 1 Adjust the waveform modification for oscillator 2 Double mode only
P2 VDF1	2 - 1 VDF1 Cutoff 2 - 2 VDF1 KBD Tracking 2 - 3 VDF1 EG Int., Vel Sens 2 - 4 VDF1 EG Time Vel Sens 2 - 5 VDF1 EG Time KBD Tracking 2 - 6 VDF1 EG	VDF1 cutoff frequency How key position affects VDF1 EG intensity and velocity sensitivity for VDF1 How key velocity affects VDF1 EG Time How key position affects VDF1 EG Time Change in VDF1 cutoff frequency over time
P3 VDF2	3 - 1 VDF2 Cutoff 3 - 2 VDF2 KBD Tracking 3 - 3 VDF2 EG Int., Vel Sens 3 - 4 VDF2 EG Time Vel Sens 3 - 5 VDF2 EG Time KBD Tracking 3 - 6 VDF2 EG	Double mode only VDF2 cutoff frequency How key position affects VDF2 EG intensity and velocity sensitivity for VDF2 How key velocity affects VDF2 EG Time How key position affects VDF2 EG Time Change in VDF2 cutoff frequency over time
P4 VDA1	4 - 1 VDA1 Velocity Sense 4 - 2 VDA1 KBD Tracking 4 - 3 VDA1 EG Time Vel Sense 4 - 4 VDA1 EG Time KBD Tracking 4 - 5 VDA1 EG	How key velocity affects VDA1 How key position affects VDA1 How key velocity affects VDA1 EG How key position affects VDA1 EG Change in VDA1 over time
P5 VDA2	5 - 1 VDA2 Velocity Sense 5 - 2 VDA2 KBD Tracking 5 - 3 VDA2 EG Time Vel Sense 5 - 4 VDA2 EG Time KBD Tracking 5 - 5 VDA2 EG	Double mode only How key velocity affects VDA2 How key position affects VDA2 How key velocity affects VDA2 EG How key position affects VDA2 EG Change in VDA2 over time

* **Double mode only** : These parameters are displayed only if P0 - 1 OSC Mode has been set to DOUBLE.

Page	Function	Parameters
P6 Pitch Modulation	6 - 1 JS, AT Pitch Bend 6 - 2 Pitch MG 1 6 - 3 Pitch MG1 Mod 6 - 4 Pitch MG2 6 - 5 Pitch MG2 Mod	How the joystick and aftertouch affect pitch Oscillator 1 pitch modulation (vibrato) Pitch MG1 modulation Oscillator 2 pitch modulation (vibrato) Double mode only Pitch MG2 modulation Double mode only
P7 VDF/VDA	Modulation 7 - 1 JS, AT Cutoff Bend 7 - 2 After Touch VDA Amp 7 - 3 VDF MG 7 - 4 VDF MG Mod	How the joystick and aftertouch will affect cutoff frequency How aftertouch will affect volume VDF modulation (wah-wah effect) VDF MG modulation
P8 Effect	8 - 1 Effect 1 Type, Dynamic Mod 8 - 2 Effect 1 Parameter 8 - 3 Effect 2 Type, Dynamic Mod 8 - 4 Effect 2 Parameter 8 - 5 Effect Placement	Select effect 1, dynamic modulation settings Parameters for effect 1 Select effect 2, dynamic modulation settings Parameters for effect 2 How effects 1 and 2 are arranged
P9 Write/Copy	9 - 1 Write Program 9 - 2 Rename Program 9 - 3 Copy Effects All 9 - 4 Copy/Swap FX 9 - 5 Copy/Swap OSC	Write a program Rename a program Copy effect parameters Copy/exchange between effects 1 and 2 Copy/exchange parameters between OSC1 and OSC2

- The total range of pitch change produced by Pitch Bend, Pitch EG, Pitch Modulation, Aftertouch, etc. is limited to one octave. (In some pitch ranges, some Multisounds will have an even narrower range of pitch change.)
- The total range of tonal change produced by the various VDF parameters and the VDF EG and VDF MG is limited to the tonal range that the VDF can control.
- The range of volume change produced by Oscillator Level and the VDA parameters is limited to the volume range that the VDA can control.
- A graphic of the EG is displayed while you edit EG parameters (Pitch EG, WS EG1/2, VDF EG1/2, VDA EG1/2).

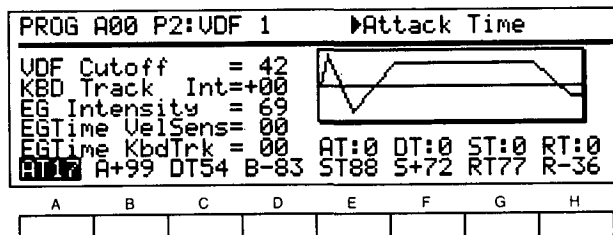

- The display is a graphic indication of the various parameters, and will differ from the actual EG shape.
- To cancel the graphic EG display, move the cursor to a non-EG parameter.

EDIT PROGRAM

Page-0 Oscillator

- P0-1 OSC Mode
- P0-2 Assign/Hold
- P0-3 OSC1 Multisound/OSC1 Level
- P0-4 OSC2 Multisound/OSC2 Level
- P0-5 OSC2 Interval, Detune
- P0-6 Pitch EG

PROG A00 P0:OSC	▶Multisound						
<pre> OSC Mode : DOUBLE Assign : POLY Hold :OFF 013:b3for9an L=54 8' EG Int=+00 5:5 126:clicker L=63 4' EG Int=+00 5:5 OSC2 Int=+00 Detune=+00 Delay=00 S-99 AT69 A+99 DT99 RT99 R+69 L+00 T+00 </pre>							
A	B	C	D	E	F	G	H

P0-1 OSC Mode

	OSC Mode	SINGLE DOUBLE DRUMS	Tone generator mode One oscillator mode (single) Two oscillator mode (double) Drums mode (drums)
--	----------	---------------------------	-----------------------------------------------------------------------------------------------------------

▼OSC Mode determines the type of the Program. The number of oscillators and the type of waveform used will depend on this setting.

- If you change the OSC Mode, you will need to re-select the OSC1 Multisound (or Drum Kit).
- When SINGLE is selected, one OSC-WS-VDF-VDA system will be used. You will be able to play up to 32 simultaneous notes.

- When DOUBLE is selected, two OSC-WS-VDF-VDA systems will be used. This allows you to create more complex sounds, but you will be able to play only up to 16 simultaneous notes.
- When DRUMS is selected, a drum kit (a collection of drum sounds) selected in Global mode will be used as the sound source, and pan settings for the drum kit will be used. Other details are the same as for SINGLE.

* The drum kit selected must be one of the two kits in the same bank used for the Program.

P0-2 Assign / Hold

[A]	Assign	POLY MONO	Number of voices sounded Play chords of up to the maximum number of voices Play monophonically.
[E]	Hold	ON/OFF	Whether or not the sound will continue after a key is released

▼Assign determines whether this Program will play polyphonically (POLY) or monophonically (MONO).

▼When Hold is set On, notes will continue sounding even after a key is released. This is useful mainly when playing the Drum Kit. Usually you will set this Off.

- If Hold is On and the VDA EG Sustain Level is other than "0" the sound will never end.

P0-3 OSC1 Multisound / Level / Pitch EG Intensity / Pan

A	Multisound Drum Kit	0 — 254, C00 — A: Drum Kit 1, 2 B: Drum Kit 1, 2 C: Drum Kit 1, 2 D: Drum Kit 1, 2	Select the OSC1 Multisound (basic waveform) (when the OSC Mode is SINGLE or DOUBLE) Select the Drum Kit (when OSC Mode is DRUMS) When Program is from Bank A When Program is from Bank B When Program is from Bank C When Program is from Bank D
D L	OSC Level	0 — 99	Volume of oscillator 1
E	Octave	32' 16' 8' 4'	Specify the octave of oscillator 1 2 octaves lower 1 octave lower Normal pitch 1 octave higher
F EG Int	Pitch EG Intensity	-99 — +99	The depth of the pitch change over time
H	Pan	A, 9:1—1:9, B, C, C+D, D, ALL	The output destination of oscillator 1

▼When the P0 - 1 OSC Mode setting is SINGLE or DOUBLE, this parameter selects the Multisound used by Oscillator 1.

- Multisounds indicated by "NT" will produce the same pitch regardless of the key that is pressed.
- Since each Multisound (waveform) has an upper limit to its pitch range, some Multisounds will produce no sound when played in high octaves.
- If an optional PCM card is inserted into the rear panel slot, you will be able to select Multisounds from the card as well. To see the selectable Multisounds, move the VALUE slider, or press the 10's HOLD/- key when using numeric key input.

Note:

Insert or remove PCM cards only when the power is turned off, or when the unit is producing no sound.

▼When the OSC Mode is set to DRUM KIT, this parameter selects either Drum Kit 1 or Drum Kit 2. However, your selection is limited to the Drum Kit in the same bank as that used for the program.

- You can assign drum sounds to a Drum Kit at P1, P2 in Global mode. However, because the Drum Kit selected will be from the same bank used for the currently selected Program, first choose a bank while in Program mode, then select a Program with the desired Drum setting before changing to the GLOBAL mode.

▼ OSC Level determines the volume of Oscillator 1. 99 is the maximum volume.

- For some sounds, high settings of OSC Level will result in distortion when chords are played. In such cases, lower the OSC Level.

▼Octave sets the basic pitch of Oscillator 1 in units of an octave. If the setting here is not 8', special attention should be paid when you set the keys of the keyboard track. In addition, when the OSC mode is DRUMS, set this to 8'.

▼Pitch EG Intensity determines the amount of the pitch EG change produced by the settings in P0-6 Pitch EG.

▼Pan (panpot) determines the output destination of oscillator 1 (i.e., the input to the effect system).

You can select A, B, C, D or ALL.

The AB balance can be adjusted → A, 9:1 — 1:9, B

The CD balance cannot be adjusted → C, C+D, D

It is possible to send the sound from all outputs → ALL

- If the OSC Mode has been set to DRUMS, this will not display "anything", and the panpot settings made for the drum kit in Global mode will be used.

P0-4 OSC 2 (Oscillator 2) (DOUBLE Mode only)

[A]	Multisound/Drum Kit	0 — 254, C00 — A/B/C/D: Drum Kit 1, 2	Select a Multisound for OSC2 Select a drum kit
[D] L	OSC Level	0 — 99	Oscillator 2 volume
[E]	Octave	32' 16' 8' 4'	Specify the octave of oscillator 2 2 octaves lower 1 octave lower Normal pitch 1 octave higher
[F] EG Int	Pitch EG Intensity	-99 — +99	The depth of the pitch change over time
[H]	Pan	A, 9:1 — 1:9, B, C, C+D, D, ALL	The output destination of oscillator 2

* Settings for Oscillator 2 can be made only if OSC Mode (P0-1) is set to DOUBLE.

▼Multisound (Multisound select) selects the Multisound for oscillator 2. The selection is the same as in P0-3 OSC1 Multisound.

▼OSC Level (oscillator level) determines the volume of oscillator 2.

▼Octave determines the octave of oscillator 2.

▼Pitch EG Intensity determines the amount of the P0-6 Pitch EG effect.

▼Pan (panpot) determines the output destination of oscillator 2.

P0-5 OSC2 Interval/Detune/Delay (DOUBLE Mode only)

[B] Int	Interval	-12 — +12	Interval (in chromatic steps) of OSC2 relative to OSC1
[D] Detune	Detune	-50 — +50	Detune between OSC1 and OSC2
[F] Delay	Delay Start	0 — 99	Time delay of OSC2 relative to OSC1

▼Interval determines the pitch difference (in chromatic steps over a range of -12 — +12) of oscillator 2 relative to oscillator 1. This can be used so that oscillators 1 and 2 form a chord.

▼Detune specifies the pitch difference between oscillators 1 and 2 in fine steps of 1 cent (-50 — +50). By slightly detuning oscillators 1 and 2, you can create richer sounds.

The following table shows how Detune affects the pitch.

Detune	OSC1 Pitch	OSC2 Pitch
+50	-25 cent	+25 cent
.	.	.
0	0	0
.	.	.
-50	+25 cent	-25 cent

If you set Detune to a positive (+) value, the pitch of OSC1 will be lowered, and the pitch of OSC2 will be raised. Negative (-) values will have the opposite effect. As this value is increased, the pitches of OSC1 and OSC2 will spread further apart from 0.

▼Delay Start specifies the time delay of oscillator 2 relative to oscillator 1 over a range of 0 — 99. (If you do not wish to use this effect, set this to a value of 0.)

P0-6 Pitch EG

PROG A00 P0:OSC				▶Release Level			
OSC Mode : DOUBLE							
Assign : POLY							
013:b3for9an		L=54					
126:clicker		L=63					
OSC2 Int=+00 Detune=+00 Delay=00							
S-99 AT69 A+99 DT99 RT99 R+89 L+00 T+00							
A	B	C	D	E	F	G	H

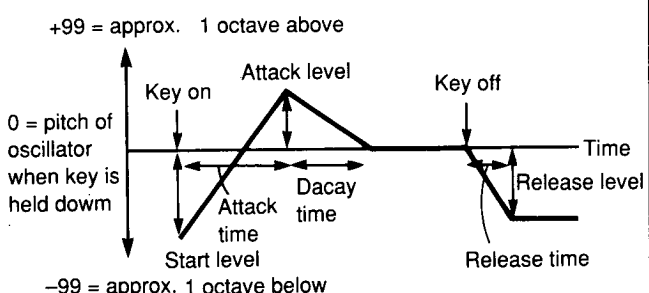
[A] S	Start Level	-99 — +99	<p>These parameters determine pitch change over time</p> 
[B] AT	Attack Time	0 — 99	
[C] A	Attack Level	-99 — +99	
[D] DT	Decay Time	0 — 99	
[E] RT	Release Time	0 — 99	
[F] R	Release Level	-99 — +99	
[G] L	EG Level Vel. Sens.	-99 — +99	How velocity affects the amount of pitch EG
[H] T	EG Time Vel. Sens.	-99 — +99	How velocity affects the speed of the pitch EG

▼ These parameters determine how the pitch will change over time.

- Inverting the + and - values for each EG level will invert the shape of the EG.
- The amount of effect is determined by the EG Intensity parameter for OSC1 in P0-3, and for OSC2 in P0-4.

▼ For positive (+) values of EG Level Vel. Sense (EG level velocity sensitivity), the pitch change will become greater as you play more strongly. (Negative (-) values will have the opposite effect.) The range of pitch change produced by the Pitch EG is limited to ±1 octave.

- For positive (+) settings

Pitch change

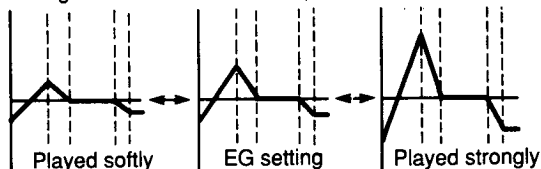

▼ For positive (+) values of EG Time Vel. Sens. (EG time velocity sensitivity), the pitch change will become faster as you play more strongly. (Negative (-) values will have the opposite effect.)

- For positive (+) settings

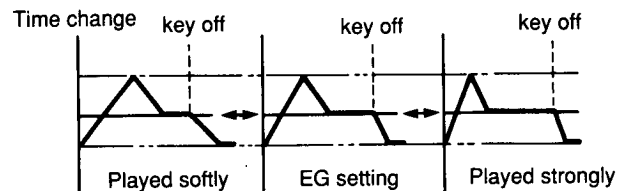

Page-1 Emphasis, Wave Shaping

P1-1 Emphasis 1
 P1-2 Emphasis 2

 P1-3 Wave Shaping 1
 P1-4 Wave Shaping 2

PROG A00 P1:EMP/W.S ▶Emphasis Inten								
Emphasis 1 Intensity=00 Vel.Sense=+00								
Emphasis 2 Intensity=00 Vel.Sense=+00								
WS1=00:CLICK1				VS+00		S99	DT70	SL30
WS2= OFF				VS+00		S99	DT00	SL99
A	B	C	D	E	F	G	H	

P1-1 Emphasis 1

A	Emphasis Intensity	0 — 99	The emphasis effect
F	Emphasis Velocity Sens	-99 — +99	How velocity will affect the emphasis effect

* Emphasis is an effect that makes the sound stand out more clearly.

▼Intensity determines the depth of the emphasis effect. Higher values will result in a greater effect.

▼Velocity Sens (velocity sensitivity) determines how key velocity will affect the amount of emphasis.

- For positive (+) values, strongly played notes will have more emphasis. For negative (-) values, strongly played notes will have less emphasis.
- As the value approaches -99 or +99, your playing dynamics will have a greater effect.

P1-2 Emphasis 2 (DOUBLE Mode only)

▼Specify the emphasis setting for oscillator 2.

- Details are the same as for P1-1.

P1-3 Wave Shaping 1

PROG A00 P1:EMP/W.S ▶Sustain Level

Emphasis 1 Intensi
Emphasis 2 Intensi



WS1=00:CLICK1 VS+00 599 DT70 SL30
WS2= OFF VS+00 599 DT00 SL99

A	B	C	D	E	F	G	H

[A]	WS Table	OFF, 0 — 59	Select the table used to shape the waveform
[E] VS	WS Velocity Sens	-99 — +99	How velocity will affect the amount of change
[F] S	WS EG Start Level	0 — 99	How wave shaping will change over time
[G] DT	WS EG Decay Time	0 — 99	
[H] SL	WS EG Sustain Level	0 — 99	

* This modifies the waveform of the PCM audio signal that is output by oscillator 1, generating harmonics that were not present in the original signal. The essential character of the sound is determined by the Multisound you select in P0-3, but these Wave Shaping parameters can be applied to change it into a very different sound.

▼WS Table (wave shaping table) selects the table that will be used to deform the PCM waveform. For example, wave shaping tables can slightly change the character of the sound, add resonance, add distortion, etc.
If you are not going to shape the waveform, select "OFF".

▼WS Velocity Sens (wave shaping velocity sensitivity) determines how EG levels (start level, sustain level) will be affected by your keyboard dynamics.

- For positive (+) values, strongly played notes will have greater change. As the value approaches -99 or +99, your playing dynamics will have a greater effect.

* The selection of some settings may create some distortion in the sound.

▼WS EG (wave shaping EG)

- These parameters determine how wave shaping will change over time..

- The WS EG levels determine how greatly the waveform will be deformed.

- Higher levels will result in greater change.

- For some tables, the volume may decrease at lower levels.

P1-4 Wave Shaping 2 (DOUBLE Mode only)

* This deforms the waveform of the PCM audio signal that is output by oscillator 2, generating harmonics that were not present in the original signal.

- The details are the same as for P1-3 Wave Shaping 1.

Page-2 VDF1

- P2-1 VDF1 Cutoff
- P2-2 VDF1 KBD Tracking
- P2-3 VDF1 EG Int./Vel Sense
- P2-4 VDF1 EG Time Vel Sense
- P2-5 VDF1 EG Time KBD Tracking
- P2-6 VDF1 EG

PROG A00 P2:VDF 1 ▶Cutoff							
VDF Cutoff = 42							
KBD Track Int=+00		Key:F#4		Mode:ALL			
EG Intensity = 69		Vel Sense =+00					
EGTime VelSens= 00		AT:0 DT:0		ST:0		RT:0	
EGTime KbdTrk = 00		AT:0 DT:0		ST:0		RT:0	
AT17 A+99 DT54 B-83		ST88 S+72		RT77		R-36	
A	B	C	D	E	F	G	H

P2-1 Cutoff

	VDF Cutoff	0 — 99	VDF1 cutoff frequency (tonal brightness)
--	------------	--------	------------------------------------------

- * The VDF (Variable Digital Filter) cuts the high frequency range of the multisound to control the tone.
- ▼Cutoff determines the VDF cutoff frequency. Lower values will result in a darker sound.

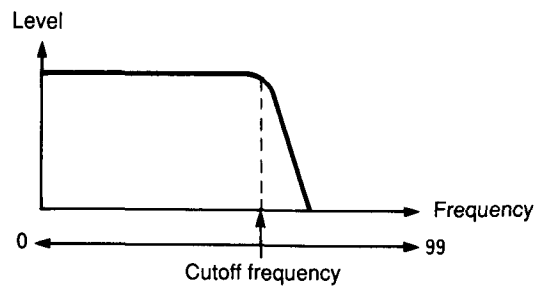

P2-2 KBD Tracking (keyboard tracking)

[A]	KBD Tracking Intensity	-99 — +99	How keyboard position will affect VDF1
[E] Key	Key	C-1 — G9	If the Keyboard Tracking Mode is LOW or HIGH, this determines the key from which keyboard tracking will begin. If ALL, this determines the key around which the keyboard will be tracked (i.e., the key at which no change will occur).
[G] Mode	KBD Tracking Mode	OFF LOW HIGH ALL	The area over which keyboard tracking will occur Keyboard tracking will not occur Keyboard tracking will occur in the low range Keyboard tracking will occur in the high range Keyboard tracking will occur over the entire range

* VDF Keyboard Tracking allows the keyboard position to affect the VDF cutoff frequency.

▼ For positive (+) values of KBD Tracking Intensity (cutoff keyboard tracking intensity), higher notes will be brighter. (Negative values will have the opposite effect.) As the value approaches +99 or -99, the change will be greater, and for a value of 0, the cutoff frequency will change in exact proportion to the pitch.

- At a value of -50, the cutoff frequency will be the same for all notes, regardless of the keyboard position.

▼ If the Keyboard Tracking Mode is LOW or HIGH, the Key parameter specifies the key from which keyboard tracking will occur. If the Keyboard Tracking Mode is ALL, the Key parameter specifies the key around which keyboard tracking will occur (i.e., the key at which the Cutoff/EG Time will not be changed). You may specify the key parameter from the keyboard.

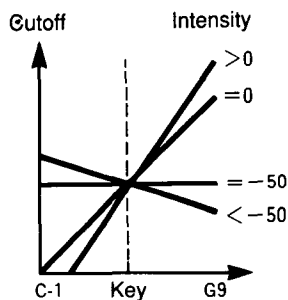

▼ KBD Tracking Mode specifies the area over which keyboard tracking will occur. When this parameter is OFF, the P2-2 keyboard tracking Intensity and P2-5 EG Time KBD Track are disabled.

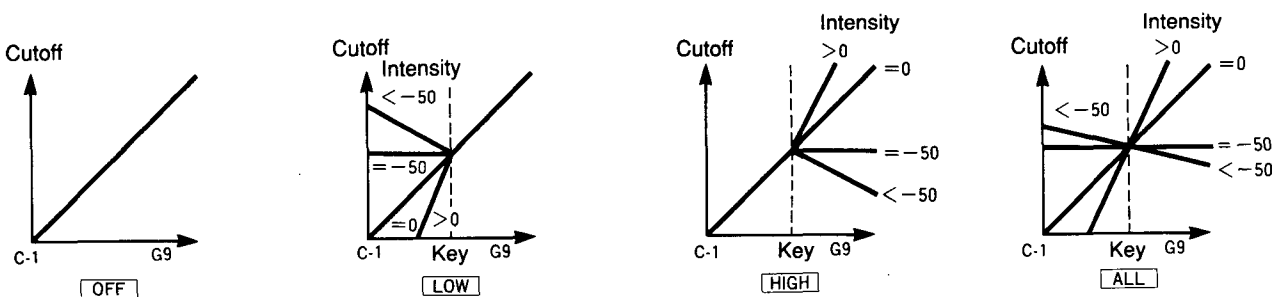

P2-3 EG Intensity

A	EG Intensity	0 — 99	The depth of tonal change produced by the VDF1 EG
E	Vel Sense	-99 — +99	How velocity will affect the VDF1 EG effect

▼EG Intensity determines the amount of the change in cutoff frequency produced by the the VDF EG in the following item (P2-6). For a value of 99, the cutoff EG will produce the maximum change.

▼Vel Sense (EG intensity velocity sensitivity) determines how keyboard dynamics will affect the tone.

- For positive (+) values, softly played notes will have less change in cutoff frequency than specified by the VDF EG.
- For negative (-) values, strongly played notes will have less change in cutoff frequency than specified by the VDF EG. (These changes are relative to the values specified by EG Intensity.)

☆For many acoustic instruments, softly played notes have less energy in the high frequency region. To simulate this, you can set the VDF to a fairly low cutoff frequency, and set all VDF EG sustain level, VDF EG intensity, and VDF EG intensity velocity sensitivity parameters to positive values.

- For positive (+) values

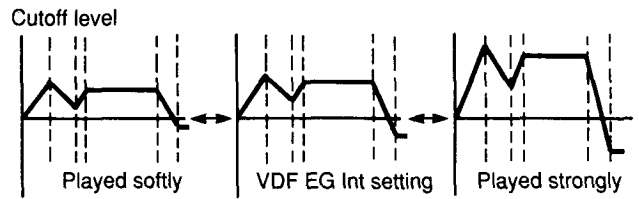

P2-4 EG Time Velocity Sense (EG time velocity sensitivity)

A	EG Time Vel. Sens	0 — 99	How velocity will affect the time of VDF1 EG
E AT	Attack Time	-, 0, +	The direction in which EG Time Velocity will affect the parameters of the VDF1 EG (for a value of 0 there will be no effect)
F DT	Decay Time	-, 0, +	
G ST	Slope Time	-, 0, +	
H RT	Release Time	-, 0, +	

▼EG Time Vel. Sense (EG time velocity sensitivity) determines how keyboard dynamics will affect the speed of the VDF EG. For a setting of "+", strongly played notes will have a shorter time (Attack/Decay/Slope/Release Time). For a setting of "-", strongly played notes will have a longer time.

- The value of EG Time Vel. Sense also applies to the other four Time parameters. You can specify +/- (the direction of change) independently for Attack, Decay, Slope, and Release. This is also true of P2-5 VDF EG Time KBD Track, P4-3 VDA EG Time Vel. Sense, and P4-4 VDA EG Time KBD Track.

- If each parameter is set to "+"

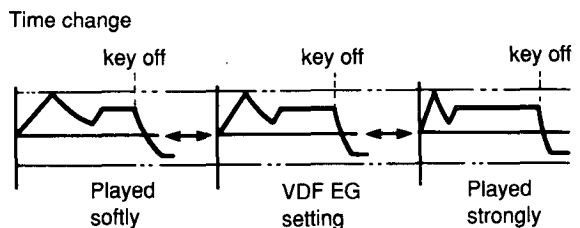

P2-5 EG Time KBD Track (EG time keyboard tracking)

[A]	EG Time KBD Track	0 — 99	How keyboard position will affect the time of VDF1 EG
[E] AT	Attack Time	-, 0, +	The direction in which EG time keyboard tracking will affect the parameters of the VDF1 EG (for a value of 0 there will be no effect)
[F] DT	Decay Time	-, 0, +	
[G] ST	Slope Time	-, 0, +	
[H] RT	Release Time	-, 0, +	

▼EG Time (EG time keyboard tracking) determines how keyboard position will affect the speed of the VDF EG. For a setting of “+”, notes above the key specified in P2-2 **[E]** will have shorter VDF EG times (Attack/Decay/Slope/Release Time). For a setting of “-”, notes above the key specified by P2-2 **[E]** will have longer VDF EG times. The key specified by P2-2 and the ‘key’ and ‘keyboard Tracking Mode’ determine the range which is affected.

- If each parameter is set to “+”

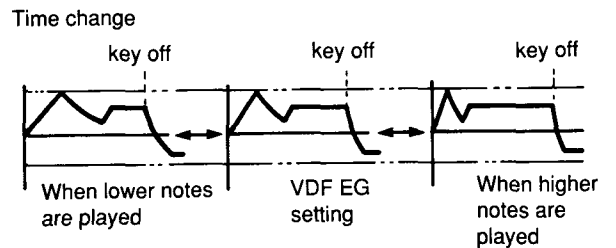

When the keyboard tracking mode = HIGH

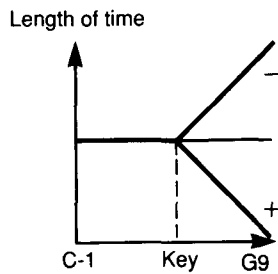

P2-6 VDF1 EG

```

PROG A00 P2:VDF 1      ▶Attack Time
VDF Cutoff      = 42
KBD Track Int  =+00
EG Intensity    = 69
EGTime Velsens = 00
EGTime KbdTrk  = 00
AT:0 DT:0 ST:0 RT:0
AT17 A+99 DT54 B-83 ST88 S+72 RT77 R-36
    
```

A	B	C	D	E	F	G	H

[A]	AT	Attack Time	0 — 99
[B]	A	Attack Level	-99 — +99
[C]	DT	Decay Time	0 — 99
[D]	B	Break Point	-99 — +99
[E]	ST	Slope Time	0 — 99
[F]	S	Sustain Level	-99 — +99
[G]	RT	Release Time	0 — 99
[H]	R	Release Level	-99 — +99

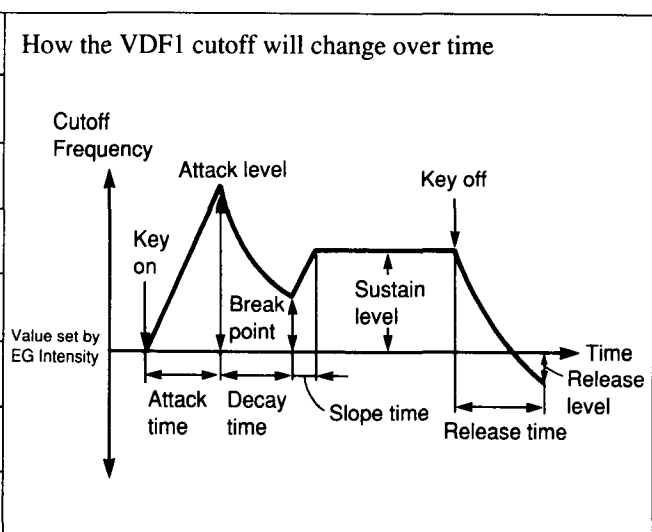

- * These parameters determine how the VDF1 cutoff frequency will change over time.
- If you invert the “+” and “-” values of the EG levels, the EG will be inverted.
- VDF1 EG Intensity will determine the overall EG levels.

Page-3 VDF2 (only for DOUBLE mode)

- P3-1 VDF2 Cutoff
- P3-2 VDF2 KBD Tracking
- P3-3 VDF2 EG Int./Vel Sense
- P3-4 VDF2 EG Time Vel Sense
- P3-5 VDF2 EG Time KBD Tracking
- P3-6 VDF2 EG

PROG A00 P3:VDF 2 ▶Cutoff							
VDF Cutoff = 99							
KBD Track Int=+00		Key:F#4		Mode:ALL			
EG Intensity = 00		Vel Sense =+70					
EGTime VelSens= 00		AT:0 DT:0		ST:0		RT:0	
EGTime KbdTrk = 00		AT:0 DT:0		ST:0		RT:0	
AT19 A+65 DT09 B+08		ST00 S+04		RT18		R+16	
A	B	C	D	E	F	G	H

▼This is the VDF for oscillator 2.

- The details are the same as for Page-2 VDF1.

☆To select DOUBLE mode or SINGLE mode, use Page-0 OSC Mode.

Page-4 VDA1

- P4-1 VDA1 Velocity Sense
- P4-2 VDA1 KBD Tracking
- P4-3 VDA1 EG Time Vel Sense
- P4-4 VDA1 EG Time KBD Tracking
- P4-5 VDA1 EG

PROG A00 P4:VDA 1 ▶Velocity Sense							
Velocity Sense=+35							
KBD Track Int=+00		Key:C-1		Mode:OFF			
EGTime VelSens= 00		AT:0 DT:0		ST:0		RT:0	
EGTime KbdTrk = 00		AT:0 DT:0		ST:0		RT:0	
AT45 A+99 DT56 B+31		ST51 S+69		RT88			
A	B	C	D	E	F	G	H

P4-1 Velocity Sense

	VDA Velocity Sense	-99 — +99	How key velocity affects the volume change produced by the VDA1
--	--------------------	-----------	-----------------------------------------------------------------

▼VDA Velocity Sense (VDA velocity sensitivity) determines how key velocity will affect the volume. For positive (+) values, softly played notes will be softer. For negative (-) values, strongly played notes will be softer. As the value approaches +99 or -99, key velocity will have a greater effect on the volume.

☆In DOUBLE mode, you can achieve a velocity crossfade effect by giving oscillators 1 and 2 opposite settings for VDA Velocity Sensitivity. This will allow you to fade between sounds by playing softly or strongly. By setting oscillators 1 and 2 to the same values (use Oscillator Copy in P9-5) and setting only the panpot parameter to different values (A and B), you can use velocity to control panning.

P4-2 KBD Tracking

A	KBD Tracking	-99 — +99	How keyboard position will affect VDA1 volume change
E Key	Key	C-1 — G9	When the Keyboard Tracking Mode is LOW or HIGH, this specifies the key from which keyboard tracking will begin to take effect. When the Keyboard Tracking Mode is ALL, this specifies the center key around which VDA1 keyboard tracking will take effect (i.e., the key which will not be affected).
G Mode	KBD Tracking Mode	OFF LOW HIGH ALL	The range over which keyboard tracking will occur Keyboard tracking will not occur Keyboard tracking will occur for the low note range Keyboard tracking will occur for the high note range Keyboard tracking will occur over the entire note range

* VDA Keyboard Tracking determines how VDA volume will be affected by the key position.

▼ For positive (+1 — +99) settings of KBD Tracking Intensity, the volume will increase as you play higher notes. For negative (-1 — -99) settings, the volume will decrease as you play higher notes.

▼ When the Keyboard Tracking Mode is LOW or HI, the Key parameter specifies the key from which keyboard tracking will begin to take effect. When the Keyboard Tracking Mode is ALL, the Key parameter specifies the center key around which keyboard tracking will take effect (i.e., the key at which volume and EG Time will not be affected). You may specify the key parameter from the keyboard.

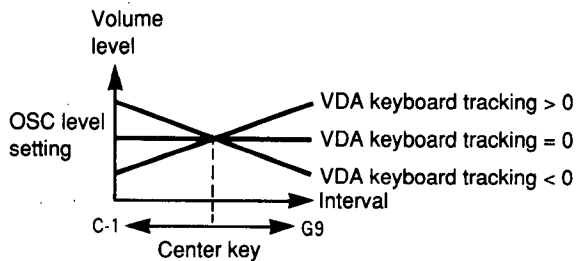

☆ In DOUBLE mode, you can create a “positional crossfade” effect by setting an identical keyboard tracking key for both oscillators 1 and 2, and giving them opposite “+” and “-” settings.

- The resulting volume after the Keyboard Tracking setting is applied will stay within the range of 0 — 99.

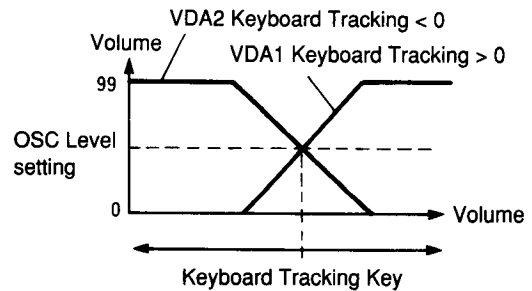

▼ KBD Tracking Mode determines the range over which keyboard tracking will occur. When this parameter is OFF, the P4-2 Keyboard Tracking and P4-4 EG Time Keyboard Track are disabled.

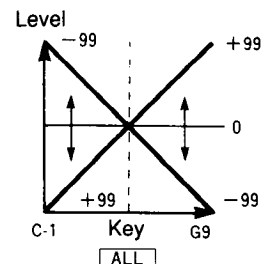
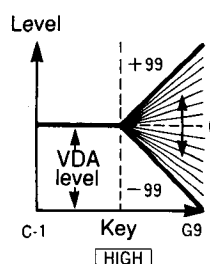
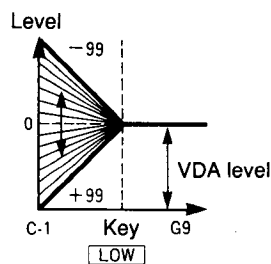
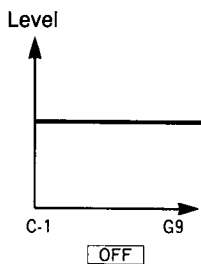

P4-3 EG Time Velocity Sensitivity

[A]	EG Time Vel. Sense	0 — 99	How key velocity affects VDA1 EG time
[E] AT	Attack Time	-, 0, +	These settings determine the direction in which the various VDA1 EG parameters (attack time, etc.) will be affected by key velocity, in the amount specified by EG Time Velocity Sensitivity. (Parameters set to 0 will not be affected by key velocity.)
[F] DT	Decay Time	-, 0, +	
[G] ST	Slope Time	-, 0, +	
[H] RT	Release Time	-, 0, +	

▼EG Time Velocity Sensitivity determines how much effect the key velocity will have on the speed of the VDA EG time parameters (Attack / Decay / Slope / Release). For each parameter, you can specify the direction of the change controlled by key velocity; parameters set to “+” will have shorter VDA EG times as you play more strongly, and parameters set to “-” will have longer VDA EG times as you play more strongly.

☆For example if Attack Time is set to “+”, strongly played notes will have a sharp attack, and softly played notes will have a gentle attack. This is especially effective for string sounds.

- When all parameters are set to “+”:

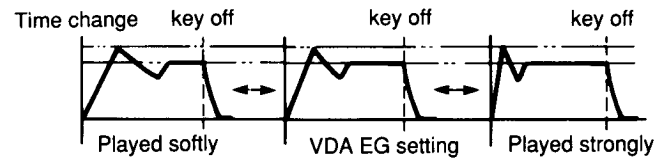

P4-4 EG Time KBD Tracking

[A]	EG Time KBD Track	0 — 99	How key position affects VDA1 EG time
[E] AT	Attack Time	-, 0, +	These settings determine the direction in which the various VDA1 EG parameters (attack time, etc.) will be affected by key position, in the amount specified by EG Time KBD Track. (Parameters set to 0 will not be affected by key position.)
[F] DT	Decay Time	-, 0, +	
[G] ST	Slope Time	-, 0, +	
[H] RT	Release Time	-, 0, +	

▼EG Time Keyboard Tracking determines how much effect the key position will have on the speed of individual VDA EG time parameters (Attack / Decay / Slope / Release). For each parameter, you can specify the direction of the change controlled by key position; as you play notes higher than the setting of P4-2 [E], parameters set to “+” will have increasingly shorter VDA EG times and parameters set to “-” will have increasingly longer VDA EG times. The key

specified by P4-2 and the ‘key’ and ‘keyboard Tracking Mode’ determine the range which is affected.

- When all parameters are set to “+”:

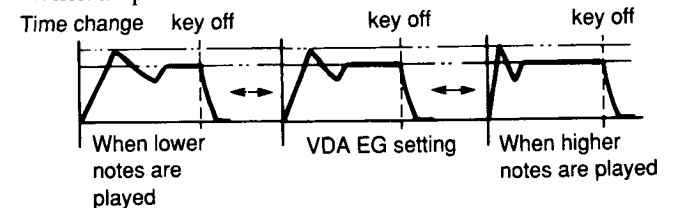

P4-5 VDA1 EG

```

PROG A00 P4:VDA 1      ▶Break Point
-----
Velocity Sense=+35
KBD Track Int=+00
EGTime VelSens= 00
EGTime KbdTrk = 00
AT45 A+99 DT56 B+31
AT:0 DT:0 ST:0 RT:0
ST51 S+69 RT88
    
```

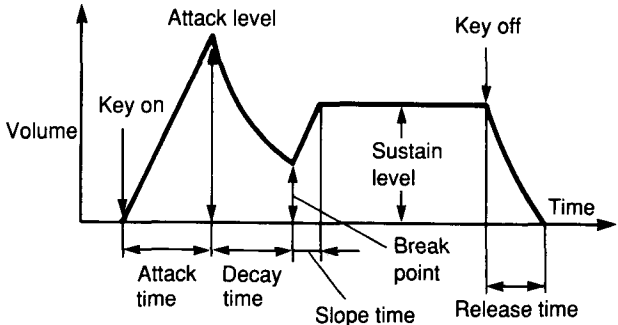

A	B	C	D	E	F	G	H

[A] AT	Attack Time	0 — 99	These parameters specify the shape of the VDA EG to determine how the volume will change over time. 
[B] A	Attack Level	0 — 99	
[C] DT	Decay Time	0 — 99	
[D] B	Break Point	0 — 99	
[E] ST	Slope Time	0 — 99	
[F] S	Sustain Level	0 — 99	
[G] RT	Release Time	0 — 99	

* The VDA (Variable Digital Amplifier) is the section that modifies the volume of the waveform.

▼The VDA EG determines how volume will change over time.

Page-5 VDA2 (only for DOUBLE mode)

- P5-1 VDA2 Velocity Sense
- P5-2 VDA2 KBD Tracking
- P5-3 VDA2 EG Time Vel Sense
- P5-4 VDA2 EG Time KBD Tracking
- P5-5 VDA2 EG

```

PROG A00 P5:VDA 2      ▶Velocity Sense
-----
Velocity Sense=+58
KBD Track Int=+00
EGTime VelSens= 00
EGTime KbdTrk = 00
AT19 A+58 DT06 B+24
Key:C-1 Mode:OFF
AT:0 DT:0 ST:0 RT:0
ST01 S+33 RT09
    
```

A	B	C	D	E	F	G	H

▼This is the VDA for oscillator 2.
 - The details are the same as for Page-4 VDA1.

☆To select DOUBLE mode or SINGLE mode, use Page-0 OSC Mode.

Page-6 Pitch Modulation

P6-1 Joy Stick Pitch Bend Range/
After Touch Bend

P6-2 Pitch MG1

P6-3 Pitch MG1 Modulation

P6-4 Pitch MG2

P6-5 Pitch MG2 Modulation

```

PROG A00 P6:Pitch MG ▶Joy-stick
JS Pitch Bend =+00 Aft Touch Bend =+00

PMG1 TRIANGLE Freq=51 I:32 DL00 FI31
      KBD F=+00 AT+JS F=0 AT00 JS00 S:OFF
PMG2 TRIANGLE Freq=63 I:17 DL00 FI00
      KBD F=+00 AT+JS F=0 AT00 JS00 S:OFF
    
```

A	B	C	D	E	F	G	H

P6-1 Joy Stick Pitch Bend Range / After Touch Bend

A	Joy Stick Pitch Bend Range	-12 — +12	The maximum effect that aftertouch will have on pitch (up to +/- 1 octave)
E	After Touch Bend	-12 — +12	The maximum effect that the joystick will have on pitch

▼Joy Stick Pitch Bend Range specifies the maximum pitch change (in half-steps) that will occur when the joystick is moved to left or right. For the maximum setting of 12, the pitch will change one octave up or down. For positive settings (+1 — +12), moving the joystick to the right will raise the pitch. Negative settings will have the opposite effect.

- For positive settings:

▼After Touch Bend specifies the maximum pitch change (over a range of -12 — +12 half-steps) that will occur when you press down on the keyboard after playing a note; i.e., aftertouch.

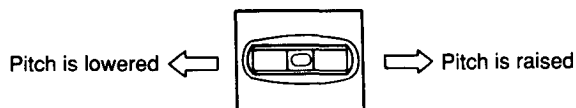

P6-2 Pitch MG1

B	Waveform	TRIANGLE	Select the modulation waveform	
		SAW UP	Triangle wave	
		SAW DOWN	Upward sawtooth wave	
		SQUARE	Downward sawtooth wave	
		RANDOM	Square wave	
			Random	
D	Freq	Frequency	0 — 99	Speed of modulation
F	I	Intensity	0 — 99	Depth of modulation
G	DL	Delay	0 — 99	Delay from when key is pressed to when modulation begins
H	FI	Fade In	0 — 99	Time from when the modulation begins to when it reaches the level specified by the Intensity parameter

* Pitch MG (pitch modulation generator) periodically varies the pitch (creates vibrato). These are the oscillator 1 Pitch MG parameters.

▼Waveform selects the modulation waveform; i.e., the “shape” of the variation in pitch.

- Triangle triangle wave (most often used)
- Saw Up upward sawtooth wave
- Saw Down downward sawtooth wave
- Square square wave
- Random irregular change

▼Frequency determines the modulation frequency (the speed of the pitch variation). A setting of 99 results in the fastest modulation.

- When Triangle wave is selected:

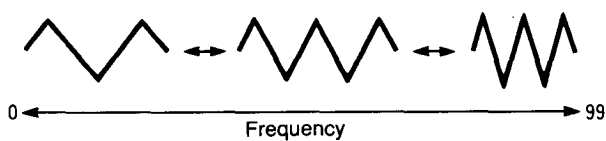

▼Delay determines the time delay from when a key is pressed to when modulation begins.

▼Fade In specifies the time from when the modulation begins to when it reaches the setting specified by the Intensity parameter.

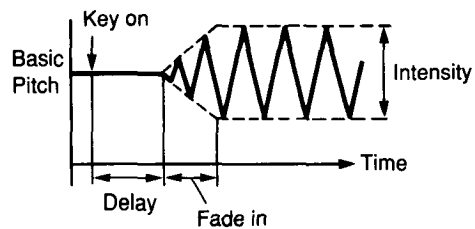

▼Intensity determines the depth of the modulation.

- When Triangle wave is selected:



P6-3 Pitch MG1 Modulation

[B] KBD F	Frequency Mod by KBD Track	-99 — +99	How keyboard tracking will affect the MG speed
[D] AT+ JS F	Frequency Mod by After Touch + Joy Stick	0 — 9	How aftertouch and the joy stick will affect the speed of Pitch MG
[F] AT	Intensity Mod by After Touch	0 — 99	How aftertouch will affect the amount of Pitch MG
[G] JS	Intensity Mode by Joy Stick	0 — 99	How the joystick will affect Pitch MG
[H] S	Key Sync	OFF ON	Modulation will apply to all notes in the same way Modulation will be started independently for each new note

▼When plus(+) is selected for Frequency Mod by KBD Track, as higher notes are played, the speed of the Pitch MG will increase accordingly. When minus (-) is selected, the speed of the Pitch MG will decrease as higher notes are played. The Pitch MG will not be affected when a value of 0 is selected. C4 is the center key.

▼Frequency Mod by After Touch + Joy Stick specifies how much the Pitch MG speed will increase in response to aftertouch and the joy stick.

▼The greater the After Touch value, the greater the affect on the Pitch MG when a key is played strongly.

▼The greater the Joy Stick value, the greater the affect on the Pitch MG when the joy stick is pushed upward.

▼If Key Sync is set ON, the modulation waveform will be restarted for each newly played note.

* After Touch allows you to affect the sound by pressing down on the keyboard after playing a note.

* The Joy Stick can be moved in the +Y axis (away from you) to control the Pitch MG effect.

Pitch MG becomes deeper
Pitch MG becomes faster

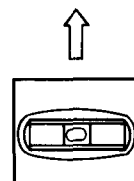

P6-4, 5 Pitch MG2, Pitch MG2 Modulation (Double mode only)

These parameters determine the Pitch MG for oscillator 2.

- The details are the same as for P6-2,3 Pitch MG1 and Pitch MG1 Mod.

Page-7 VDF/VDA Modulation

PROG A00 P7:VDF MG ▶Joy-stick							
JS Cutoff Sweep=+00				AT Cutoff Sweep=+00			
				AT VDA Amp Mod =+00			
VDFMG TRIANGLE Freq=00				I:00 DL00			
OSC:OFF				AT00 JS00 S:OFF			
A	B	C	D	E	F	G	H

P7-1 VDF Sweep by JS, AT (VDF Sweep by Joy Stick, After Touch)

A	Joy Stick VDF Sweep Intensity	-99 — +99	How the joystick will affect VDF cutoff
E	After Touch VDF Cutoff	-99 — +99	How aftertouch will affect cutoff (tone)

▼VDF Sweep Int. (VDF sweep intensity) specifies how the VDF cutoff will change when the joystick is moved to left or right. For positive values, moving the joystick to the right will raise the cutoff value. Negative values will have the opposite effect.

- For positive (+) values:

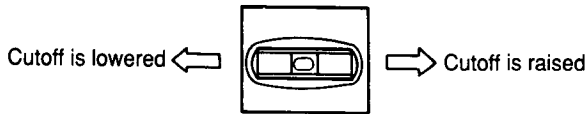





▼For positive values of After Touch VDF Cutoff, pressing down on the keyboard will increase the cutoff value (the sound will become brighter). Negative values will have the opposite effect.

P7-2 VDA Amp Mod by After Touch

E	After Touch VDA Amplitude	-99 — +99	How aftertouch will affect volume
----------	---------------------------	-----------	-----------------------------------

▼For positive values of After Touch VDA Amplitude, pressing down on the keyboard will increase the volume. Negative values will have the opposite effect.

P7-3 VDF MG

B	Waveform	TRIANGLE SAW UP SAW DOWN SQUARE RANDOM	Select the modulation waveform Triangle wave  Upward sawtooth wave  Downward sawtooth wave  Square wave  Random 
D Freq	Frequency	0 — 99	Speed of modulation
F I	Intensity	0 — 99	The intensity of modulation
G DL	Delay	0 — 99	The time from when a key is pressed to when modulation will begin

▼VDF MG (VDF modulation) creates periodic variation in the Cutoff Frequency, resulting in a “wah-wah” effect.
 - The details are the same as for Pitch MG, but there is no Fade In parameter. (The Fade In time will depend on the Delay Time.)

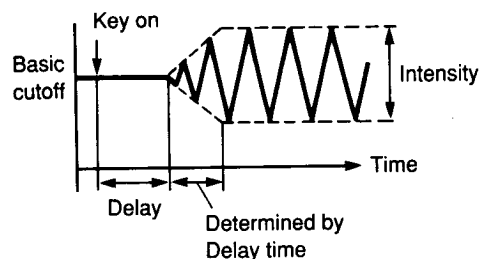

P7-4 VDF MG Modulation

B OSC	OSC Select	OFF OSC1 OSC2 BOTH	No modulation effect Modulation will affect only VDF1 Modulation will affect only VDF2 Modulation will affect both VDF1 and VDF2
F AT	Intensity Mod by After Touch	0 — 99	How aftertouch affects VDF MG
G JS	Intensity Mod by Joy Stick	0 — 99	How the joy stick affects VDF MG
H S	Key Sync	OFF ON	Modulation will apply to all keys in the same way Modulation will be re-started for each key-on

▼Since VDF MG is common to both VDF1 and VDF2, OSC Select specifies the VDF to which the MG will be applied.

▼For higher values of MG Int by AT, aftertouch will increase the effect of the VDF. For a value of 0, there will be no change.

▼For higher values of MG Int by Joy Stick, moving the joystick toward you will deepen the effect of the VDF MG.

▼If Key Sync is set ON, the modulation waveform will be re-started for each key when it is pressed.

- Details are the same as for P6-3 Key Sync
 * VDF Cutoff MG depth is controlled by the -Y direction of the joy stick (i.e. pulling the joystick toward you).

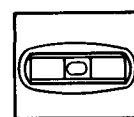

VDF MG becomes deeper

Page-8 Effect

For details of the following parameters, refer to "Effect Parameters" (p.49).

- P8-1 Effect 1 Type,Dynamic Mod
- P8-2 Effect 1 Parameter

- P8-3 Effect 2 Type,Dynamic Mod
- P8-4 Effect 2 Parameter
- P8-5 Effect Placement

PROG A00 P8:EFFECT							
FX1 19:Chorus 1 : ON Mod:S+J(+) I+15 0010 50.30 M60 TRI L+06 H+00 →20:80							
FX2 01:Hall : ON Mod:PEDAL1 I+15 3.2 D060 E62 HD30 L+00 H+00 →44:56 [SERIAL] Out3 = OFF Out4 = OFF							
A	B	C	D	E	F	G	H

- Effect settings made here will apply only to the Program for which they are made.
- In Program mode, the Pan (A — D) output of the oscillator is sent to the effect units.

* If a cursor key **[A]** — **[H]** is held down while the EDIT PROG key is pressed in the COMBINATION or EDIT COMBINATION mode, settings made in the combination mode will be retained in the EDIT PROGRAM mode. As a result, this page would not then be selected.

Page-9 Write/Copy

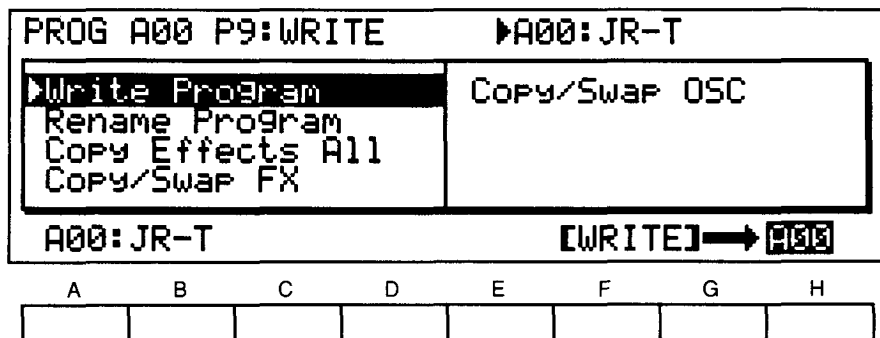

P9-1 Write

[F]		[WRITE]	Execute the writing operation
[H]		A00 — B99, C00 — D99	The Program number to write

▼ This operation is used to write an edited Program into internal memory or a RAM card.

■ On the 01/W, to write (save) a program to disk, use the operation in Disk mode. This will save all 200 internal programs to disk.

- (1) Select the Program number for the writing destination (cursor key [H]). The Program name of the writing destination will be displayed at the top right position.
- (2) Press [WRITE] (cursor key [F]).
- (3) The display will ask "Are You Sure?". If you are sure you want to write the data into memory, press [YES] (cursor key [E]).
 - Be aware that the data previously in that memory will be lost.
 - To quit without writing, press [NO] (cursor key [G]).
 - Writing is not possible if Program Memory Protect has been turned on. (Turn off memory protect in Global mode.)

(4) When writing is completed, the display will show «Write Completed».

- Press a cursor key ([A] — [H]) to return to the display from which you began the procedure.

☆ When writing a Drums program to a different Bank during Oscillator mode, the Drum Kit used will be changed to match the one in the Bank of the writing destination. Be sure to copy these together.

☆ To copy a Program from internal memory to another program number, select the source Program in Program mode, and use this writing function to write it into the destination memory number.

☆ Press the REC/WRITE key, if you want to write data onto the currently selected Program. Writing can be done without changing to this page.

P9-2 Rename

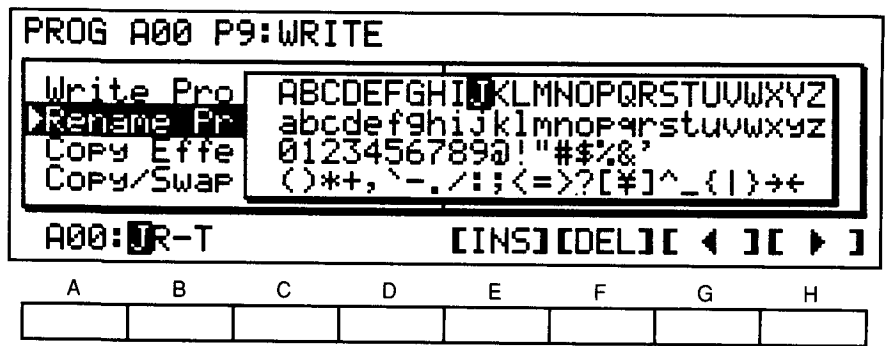

[E]		[INS]	Insert one character at the rename cursor position
[F]		[DEL]	Delete one character at the rename cursor position
[G]		[<]	Move the rename cursor to the left
[H]		[>]	Move the rename cursor to the right

▼Use this function to modify the Program name.

▼Use [<] (cursor key [G]), [>] (cursor key [H]), [INS] (cursor key [E]), [DEL] (cursor key [F]), the VALUE slider, and the Δ / ▽ keys to modify the Program name. Pressing [INS] will insert one copy of the character at the

cursor position to the right of the cursor position.

Pressing [DEL] will delete the character at the cursor position.

- A Program name consists of up to 10 characters and symbols.

P9-3 Copy Effects All

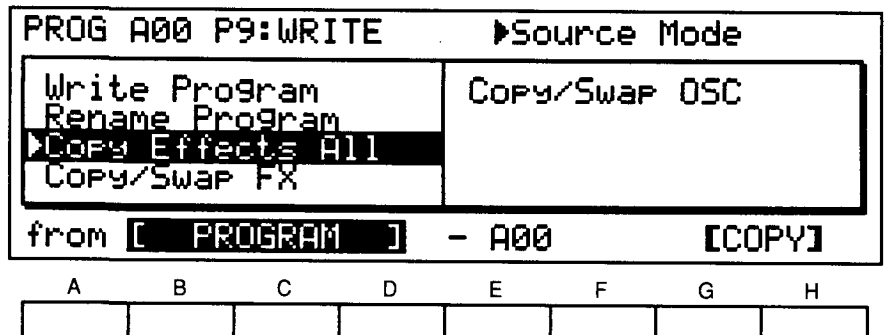

[B]	Source Mode	PROGRAM COMBINATION SONG	Copy from a Program Copy from a Combination Copy from a Song
[E]	Source Number	A00 — B99/C00 — D99 A00 — B99/C00 — D99 0 — 9/C0 — D9	The Program number to copy The Combination number to copy The Song number to copy
[G]		[COPY]	Execute copying

■ This operation copies only the effect parameters from a Combination, Program, or Song.

- The data will be copied into the Program being edited.

(1) Select the type of data ([B]) from which you want to copy the effect parameters.

(2) Select the memory number (**[E]**) from which you want to copy the effect parameters. If you are copying effect parameters from a Program, select the Program number. If from a Combination, select the Combination number. If from a Song, select a Song number.

(3) Press **[COPY]** (**[G]**) to copy the effect parameters from the selected memory.

P9-4 Copy/Swap FX

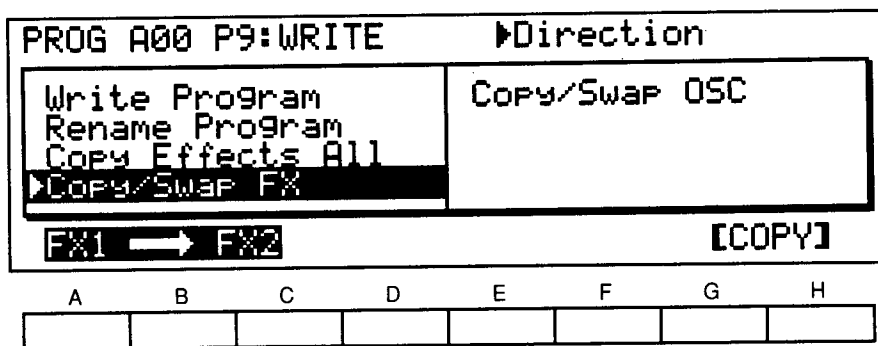

[A]		FX1 → FX2 FX1 ← FX2 FX1 ↔ FX2	Copy FX1 settings to FX2 Copy FX2 settings to FX1 Swap (exchange) settings of FX1 and FX2
[G]		[COPY]	Execute the copy/swap operation

■ This operation copies (or exchanges) parameter values between Effect 1 and Effect 2.

P9-5 Copy/Swap OSC

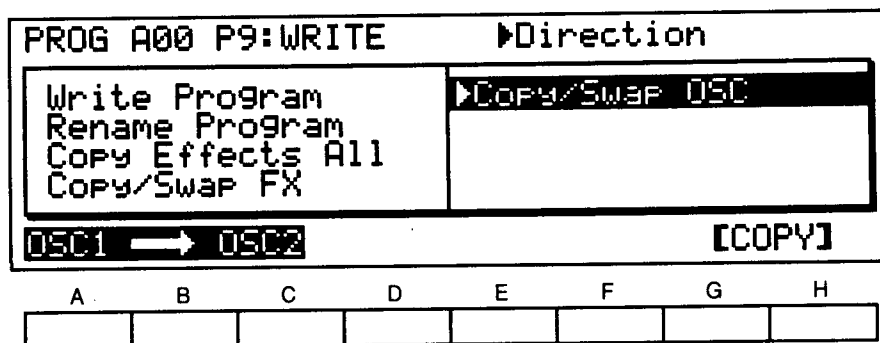

[A]		OSC1 → OSC2 OSC1 ← OSC2 OSC1 ↔ OSC2	Copy OSC1 settings to OSC2 Copy OSC2 settings to OSC1 Swap (exchange) settings of OSC1 and OSC2
[G]		[COPY]	Execute the copy/swap operation

■ This operation copies (or exchanges) oscillator parameters (OSC, Emphasis, WS, VDF, VDA, Pitch MG, VDF MG Destination) between the oscillators.

* Please note that Multisound and Octave will not be copied.

3. EFFECT PARAMETERS

The 01/WFD•01/W has two systems of stereo digital multi-effect units. Each effect unit can produce a wide variety of effects such as reverb, delay, chorus, flanger, phase shifter, distortion, and exciter. effect parameters can be edited for detailed adjustments.

effect settings can be made separately as part of Program parameters, Combination parameters, and Song parameters, allowing you to use the most appropriate effect setup for each situation.

- When playing Programs, each sound can have its own effect settings, so you can use effects as part of the process of creating a sound.
- When playing Drum Kit Programs, Combinations, or when using the sequencer, it is also possible to apply effects to specific sounds.

You can edit effect parameters in Edit Program mode, Edit Combination mode, and Sequencer mode. (The editing parameters are the same.)

The effect section has four inputs (A, B, C, D), four outputs (1/L, 2/R, 3, 4), two effect units, and two panpots (PAN 3,4). The two effects can be connected either in serial or in parallel. (In the 01/WFD•01/W, all signal processing and routing is done as digital data, and the signal is converted from digital to analog audio only after it has passed through the effect section.)

About dynamic modulation

Effect parameters (such as Dry:effect balance, Modulation Speed, etc.) can be controlled in realtime using the joy stick, aftertouch, or other controllers, for a greater range of musical expression.

Dynamic modulation settings can be made independently for each of the two effect systems (the control source and sensitivity). However, the parameters can be controlled for each effect, and an arrow “→” will be shown on the left of the parameter.

EFFECT PLACEMENT

Placement = Serial

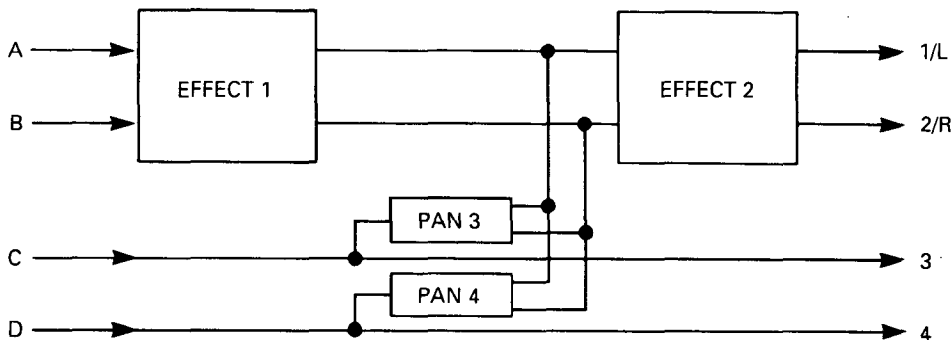

In serial mode, two effects 1 and 2 are applied to inputs A and B, and the sound is output from 1/L and 2/R. The outputs 3 and 4 will output the signals directly from C and D. It is also possible to mix the input signal from C and D into the two inputs of effect 2.

☆For example by using inputs C and D, you can avoid applying effect 1 to a specific sound, or apply effect 1 only to a specific sound and then apply effect 2 to all the sounds.

Placement = Parallel

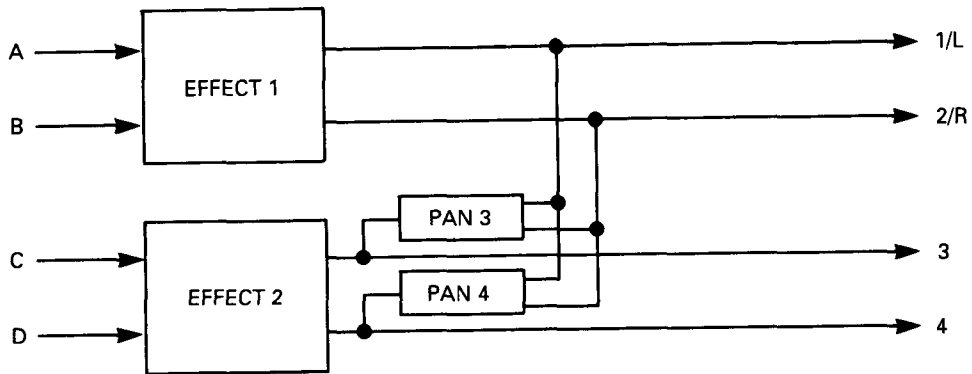

In Parallel mode, separate effects are applied to inputs A and B and inputs C and D, and the output is sent respectively from 1/L and 2/R, and 3 and 4. It is also possible to mix the output of 3 and 4 into the output of 1/L and 2/R.

Placement = Parallel 2

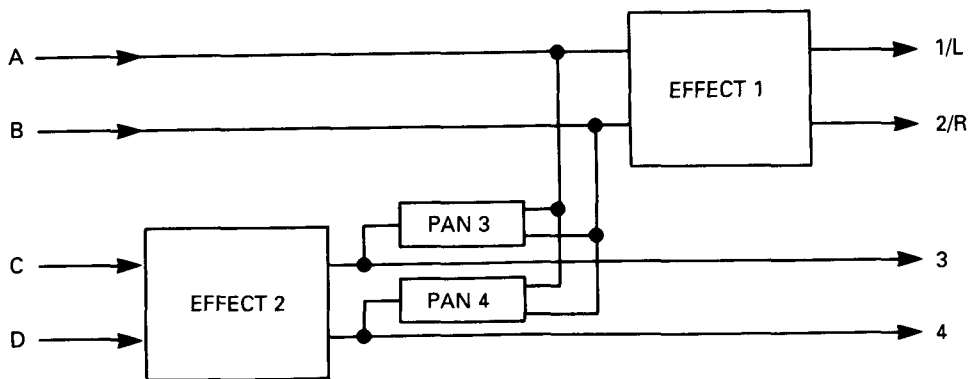

Effect 1 is applied to input from A and B.
Effect 2 is applied to input from C and D, and this data can then be distributed to Effect 1.

- ☆ The Out 3 Pan and Out 4 Pan settings can be used in the following ways.
 - When different sounds are input to C and D, you can create a stereo mix by using Out 3 Pan and Out 4 Pan to pan these sounds to the stereo output.
 - There are two types of effects; stereo-type effects (1 — 37), and effects in which each channel has a different effect (38 — 47).
 - The input to A—D is determined by the panpot settings for the Oscillator parameters, Timbre parameters, and Track parameters in Edit Program mode, Edit Combination mode, and Sequencer mode, respectively.

- ☆ If stereo-type effects have been selected for effect units 1/2 when effect Placement is Parallel, you can set output 3 Pan to L and output 4 Pan to R to send the outputs of effects 1 and 2 as a stereo mix.
- ☆ If you are using an external effect or mixer, it is also possible to set output 3 Pan and output 4 Pan to "OFF", and use outputs 3/4 as separate outputs.
- * You can monitor only output 1/L and 2/R with the headphones. Therefore, the sound input from C and D cannot be monitored when output 3 Pan and output 4 Pan are set to OFF.

PROG A00 P8:EFFECT							
FX1 19:Chorus 1 : ON Mod:S+J(+) I+15							
0010 50.30 M60 TRI L+06 H+00 →20:80							
FX2 01:Hall : ON Mod:PEDAL1 I+15							
3.2 D060 E62 HD30 L+00 H+00 →44:56							
[SERIAL] Out3 = OFF Out4 = OFF							
A	B	C	D	E	F	G	H

P8-1 Effect1

[A]	Effect Type	00 01 — 47	No effect is used Select the Effect Type
[E]	Switch	OFF, ON	Switch the effect ON or OFF
[F] Mod	Dynamic Modulation Source	NONE JS (+Y) JS (-Y) AFTT PEDAL 1 PEDAL 2 VDA EG SLIDER S + J (+) S + J (-) S + AFTT S + PDL1 S + PDL2 S + VDA	Dynamic Modulation Control Source Not used Joystick (+Y) Joystick (-Y) After Touch Foot Pedal 1 Foot Pedal 2 VDA EG VALUE Slider Joystick (+Y) Joystick (-Y) After Touch Foot Pedal 1 Foot Pedal 2 VDA EG
[H] I	Dynamic Modulation Intensity	-15 — +15	Specify the depth of Effect Dynamic Modulation

- When you select the effect Type, the effect parameters will be set to their initial values.
- If one effect unit is set to 24:Symphonic Ensemble, it will not be possible to select the following effects at the same time.

- 19 — 23 CHORUS
- 24 SYMPHONIC ENSEMBLE
- 25 — 27 FLANGER
- 32,33 PHASER
- 34 ROTARY SPEAKER
- 35,36 TREMOLO
- 38, 39 CHORUS, FLANGER-DELAY
- 42 DELAY/CHORUS
- 43 DELAY/FLANGER
- 46 DELAY/PHASER
- 47 DELAY/ROTARY SPEAKER

- If the foot switch has been assigned to effect ON/OFF, the effect will be switched on/off each time you press the foot switch. SWITCH[E] displays and sets this status. Also, the control change function lets you use a MIDI sequencer to turn Control No.91 (Effect 1) and No.92 (Effect 2) ON and OFF.
- When you select a Program, Combination, or Song, the on/off status will be set to the condition specified by the effect parameters in that mode.
- ☆For all effects other than Delay (13 — 14), Chorus (19 — 20), Exciter (28), and Tremolo (35 — 36) the equalizer settings (LOW EQ and HIGH EQ) are valid even when the effect ON/OFF is off.
While editing a sound, you can turn all effects (including the equalizer) off by setting the effect Type to “No effect”.

- If the selected effect has a parameter that can be controlled by dynamic modulation (indicated by an “→” at the left), you can specify the Dynamic Modulation Source [F] and the Intensity [H] to control that parameter in realtime.
- The “→” symbol will not be displayed for the Rotary Speaker (34) and Delay/Rotary Speaker (47) effects, but switching between slow and fast can be carried out.
- “Slider”, “S + J (+)”, etc. on the Dynamic Modulation source indicate the VALUE slider. If you are not using the Performance Editor in Program or Combination mode, you can use Dynamic Modulation with the VALUE slider. “▶

FX1” or “▶ FX2” will be displayed to the right of the Program combination name.

- “VDA EG” on the Dynamic Modulation has 32 voices for each VDA EG.
- When a foot switch is to be used as a Dynamic Modulation source, assign the switch to “Effect Control” in the Global mode.
- When a pedal is used to control dynamic modulation, set the function of that pedal to EFFECT CONTROL in the Global Mode. Also, EFFECT CONTROLS 1 and 2 (Bn, OC, vv or Bn, OD, vv) transmitted via MIDI correspond to foot pedals 1 and 2 (during operation in Global Channel).

P8-2 Effect 1 Parameter

▼These are the parameters for effect 1.

- The parameters will depend on the effect type. Please refer to the explanation of each effect type.

P8-3 Effect 2

▼This selects the effect type for effect unit 2.

- The details are the same as for effect unit 1.

P8-4 Effect 2 Parameter

▼These are the parameters for effect 2.

- The details are the same as for effect unit 1.

P8-5 Effect Placement

[A]	Effect Placement	SERIAL PARALLEL PARALLEL 2	Specify how the effect units are connected Serial Parallel Parallel 2
[C]	Out3 Panpot	OFF L, 99:1 — 1:99, R	The sound from out 3 is not sent from L or R out 3 pan setting (L:R balance)
[F]	Out4 Panpot	OFF L, 99:1 — 1:99, R	The sound from out 4 is not sent from L or R out 4 pan setting (L:R balance)

▼These parameters determine the effect Placement and the panning of outputs 3 and 4.

- When editing effect Placement, Out 3 Panpot, or Out 4 Panpot, the effect connections will be displayed graphically.

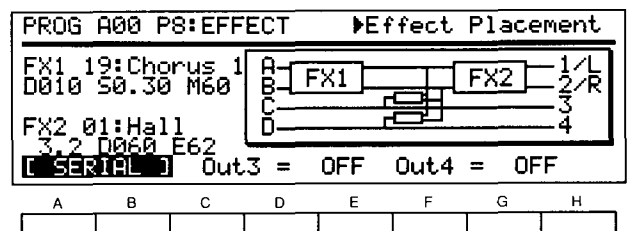

- To cancel the graphic display, move the cursor to another line.

NO EFFECT

0. NO EFFECT

When no effects are used, select "NO EFFECT".

☆ If any of Delay (13-14), Chorus (19-20), Exciter (28), or Tremolo (35-36) is selected, the settings of equalizer (EQ Low, EQ High) will be used even if the Effect Switch is turned OFF. If you want to turn off all the effects including equalizer, select "NO EFFECT".

PROG A00 P8:EFFECT							
FX1 00:No Effect :ON Mod:NONE I+00							
No Effect							
FX2 01:Hall :ON Mod:VDA-EG I+15							
3.2 0060 E62 HD30 L+00 H+00 →84:16							
[SERIAL] Out3 = OFF Out4 = OFF							
A	B	C	D	E	F	G	H

REVERB

This effect simulates the reverberant acoustics of a hall, adding ambience to the sound.

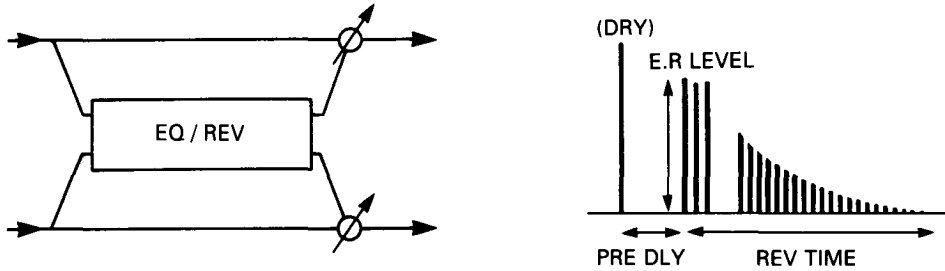

1. HALL

The acoustic ambience of a natural-sounding hall.

2. ENSEMBLE HALL

The acoustic ambience of a hall suitable for string and brass ensembles.

3. CONCERT HALL

The acoustic ambience of a larger hall, with emphasized early reflections.

4. ROOM

The acoustic ambience of a smaller room.

5. LARGE ROOM

This effect is a room-type reverb with emphasized density. With Reverb Time settings of about 0.5 seconds, the result will be similar to a gating effect.

6. LIVE STAGE

The acoustic ambience of a fairly large room.

7. WET PLATE

A simulation of a heavily applied plate reverb device.

8. DRY PLATE

A simulation of a lightly applied plate reverb device.

9. SPRING REVERB

A simulation of a spring reverb device.

A	B	C	D	E	F	G	H

```

PROG A00 P8:EFFECT
-----
FX1 02:Ensemble Hall:ON  Mod:JS(+Y) I+15
    2.8 D040 E46 HD32      L-01 H-02 +70:30
FX2 03:Concert Hall :ON  Mod:VDA-EG I+15
    3.8 D120 E46 HD40      L+00 H-02 +75:25
[ SERIAL ] Out3 = OFF Out4 = OFF
  
```

A	Reverb Time	0.2 — 9.9 [sec] (HALL type) 0.2 — 4.9 [sec] (ROOM type) 00 — 99 (PLATE type)	The time over which the reverberation will decay
B D	Pre Delay	0 — 200 [ms]	The delay between the direct sound and the initial reflections
C E	E.R Level	0 — 99 (HALL/ROOM type) 1 — 10 (PLATE type)	The level of the early reflections
D HD	High Damp	0 — 99 [%]	Higher values will result in a faster decay for high frequencies
F L	EQ Low	-12 — +12 [dB]	The amount of boost or cut for the low frequency range
G H	EQ High	-12 — +12 [dB]	The amount of boost or cut for the high frequency range
H	DRY:FX Balance	DRY, 99:1 — 1:99, FX	The output balance between direct and processed sound

For effects 1 — 9, you can use dynamic modulation to control the Dry:effect Balance.

EARLY REFLECTION

The Early Reflection effects create the early reflections that are an important element in determining the qualities of an acoustic environment. By various settings of the Early Reflection Time parameter, you can create a variety of effects such as thickening the sound, or creating echo-like reflections.

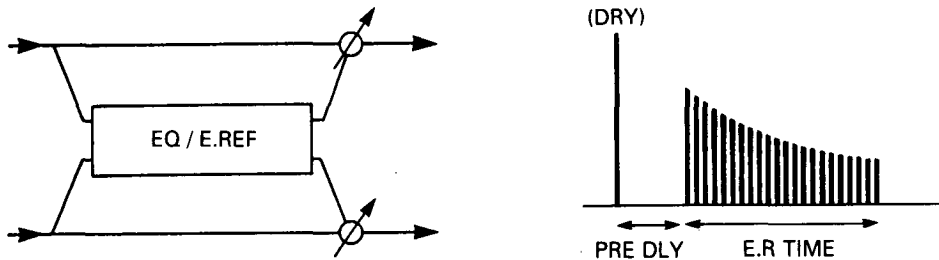

10. EARLY REFLECTION I

This effect emphasizes the low frequency range, and is effective when used on gated sounds such as drums.

11. EARLY REFLECTION II

The level of the early reflections produced by this effect will change over time in a different way than with the Effect 10. Early Reflection I, giving it a different character.

12. EARLY REFLECTION III

This effect creates early reflections with an envelope opposite from Early Reflection I and Early Reflection II. When used on sound with a strong attack, such as cymbals, it can create reverse-tape effects.

```

PROG A00 P8:EFFECT
-----
FX1 10:Early Ref 1 :ON Mod:JS(+Y) I+15
220ms D015 L+03 H-05 +67:33
FX2 11:Early Ref 2 :ON Mod:VDA-EG I+15
200ms D020 L+00 H+00 +60:40
[ SERIAL ] Out3 = OFF Out4 = OFF
    
```

A	B	C	D	E	F	G	H

[A]	E.R Time	100 — 800 [ms]	The early reflection time (10ms/1 Step)
[C] D	Pre Delay	0 — 200 [ms]	The delay between the direct sound and the initial reflections
[F] L	EQ Low	-12 — +12 [dB]	The amount of boost or cut for the low frequency range
[G] H	EQ High	-12 — +12 [dB]	The amount of boost or cut for the high frequency range
[H]	DRY:FX Balance	DRY, 99:1 — 1:99, FX	The output balance between direct and processed sound

For effects 10 — 12, you can use dynamic modulation to control the Dry:effect Balance.

STEREO DELAY

These effects create stereo delay patterns in which you can set the left and right delay times independently. By using appropriate high damp settings, you can make the repeated delays decay in a natural way.

13. STEREO DELAY

This stereo delay has two delay channels with feedback. The delay times will be the same for both channels.

14. CROSS DELAY

This stereo delay has two delay channels with feedback from one channel to the other, to make the sound move between left and right.

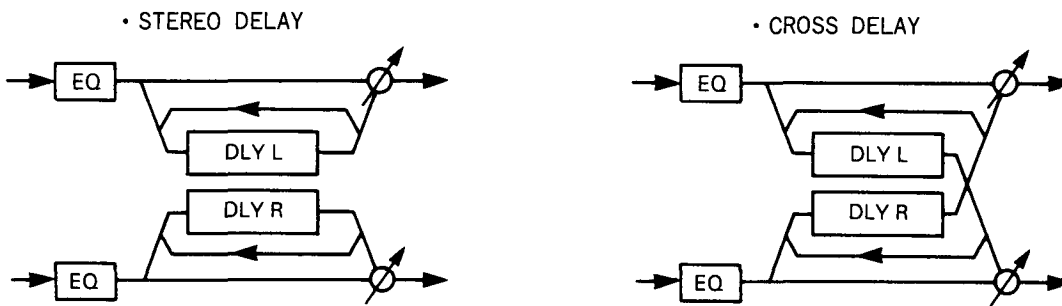

```

PROG A00 P8:EFFECT
-----
FX1 13: Stereo Delay : ON  Mod: JS(+Y) I+15
L250 R260 F-40 HD30      L+00 H+00 →75:25
FX2 14: Cross Delay  : ON  Mod: VDA-EG I+15
L180 R360 F+80 HD10     L+00 H+00 →70:30
[ SERIAL ] Out3 = OFF  Out4 = OFF
    
```

A	B	C	D	E	F	G	H

[A] L	Delay Time Left	0 — 500 [ms]	The time from the direct sound to the processed sound in the left channel (A or C)
[B] R	Delay Time Right	0 — 500 [ms]	The time from the direct sound to the processed sound in the right channel (B or D)
[C] F	Feed back	-99 — +99 [%]	The amount of feedback (negative values invert the phase)
[D] HD	High Damp	0 — 99 [%]	Higher values will result in a faster decay for high frequencies
[F] L	EQ Low	-12 — +12 [dB]	The amount of boost or cut for the low frequency range
[G] H	EQ High	-12 — +12 [dB]	The amount of boost or cut for the high frequency range
[H]	DRY: FX Balance	DRY, 99:1 — 1: 99, FX	The output balance between direct and processed sound

For effects 13 and 14, you can use dynamic modulation to control the Dry:Effect Balance.

DUAL MONO DELAY

15. DUAL MONO DELAY

This effect provides two independent mono delays.

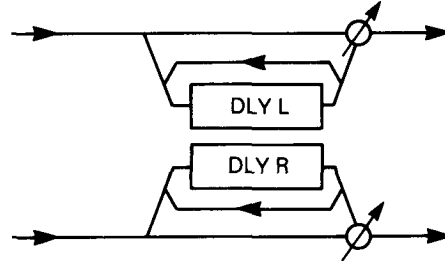

```

PROG A00 P8:EFFECT
-----
FX1 15: Dual Delay :ON  Mod:JS(+Y) I+15
    250 F+50 HD10→70:30 260 F+50 HD10→70:30

FX2 15: Dual Delay :ON  Mod:UDA-EG I+15
    250 F+50 HD10→ DRY 260 F+50 HD10→ DRY
[ SERIAL ] Out3 = OFF Out4 = OFF
    
```

A	B	C	D	E	F	G	H

[A]	Delay Time L	0 — 500 [ms]	The time from the direct sound to the processed sound for the left channel
[B] F	Feedback L	-99 — +99 [%]	The amount of feedback for the left channel (negative values invert the phase)
[C] HD	High Damp L	0 — 99 [%]	Higher values will result in a faster decay for high frequencies
[D]	DRY:FX Balance L	DRY, 99:1 — 1:99, FX	The output balance between direct and processed sound for the left channel
[E]	Delay Time R	0 — 500 [ms]	The time from the direct sound to the processed sound for the right channel
[F] F	Feedback R	-99 — +99 [%]	The amount of feedback for the right channel (negative values invert the phase)
[G] HD	High Damp R	0 — 99 [%]	Higher values will result in a faster decay for high frequencies
[H]	DRY:FX Balance R	DRY, 99:1 — 1:99, FX	The output balance between direct and processed sound for the right channel

For this effect, you can use dynamic modulation to control the Dry: Effect Balance.

MULTI TAP DELAY

In this effect, an equalizer is applied to each effect input, and then the signal is sent to two independent delays connected in series. The output of the second delay is fed back into the input.

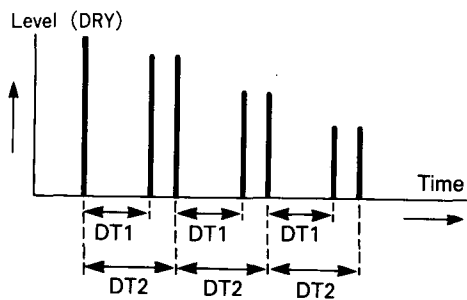

When $DT1 < DT2$

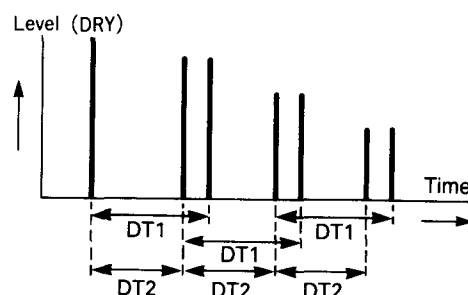

When $DT1 > DT2$

16. MULTI TAP DELAY I

This is a two-channel multi-repeat delay.

17. MULTI TAP DELAY II

This is a two-channel multi-repeat delay with cross-panning.

18. MULTI TAP DELAY III

This is a two-channel multi-repeat delay with cross-feedback.

- MULTI TAP DELAY I, II

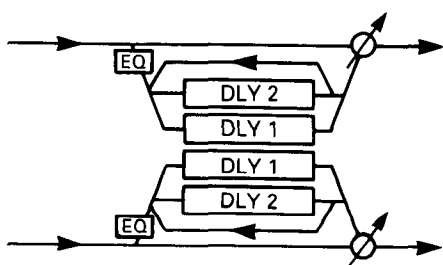

- MULTI TAP DELAY III

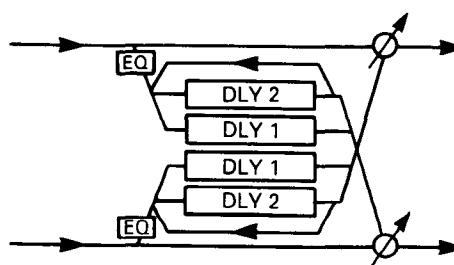

3. EFFECT PARAMETERS

```

PROG A00 P8:EFFECT
-----
FX1 16:Multitap D1y1:ON Mod:JS(+Y) I+15
D1T300 D2T400 FB+50 L+00 H+00 +50:50
FX2 17:Multitap D1y2:ON Mod:VDA-EG I+15
D1T267 D2T400 FB+50 L+00 H+00 +50:50
[ SERIAL ] Out3 = OFF Out4 = OFF

```

A	B	C	D	E	F	G	H

A	D1T	Delay Time 1	0 — 500 [ms]	The time from the direct sound to the processed sound
C	D2T	Delay Time 2	0 — 500 [ms]	The time from the direct sound to the processed sound
D	FB	Feedback	-99 — +99	The amount of feedback (negative values invert the phase)
F	L	EQ Low	-12 — +12 [dB]	The amount of boost or cut for the low frequency range
G	H	EQ High	-12 — +12 [dB]	The amount of boost or cut for the high frequency range
H		DRY:FX Balance	DRY, 99:1 — 1:99, FX	The output balance between direct and processed sound

For effects 16, 17, and 18, you can use dynamic modulation to control the Dry:Effect Balance.

CHORUS

These are stereo-type effects which use two chorus units, and are an effective way to add spaciousness and depth to any type of sound; piano, strings, brass, etc.

19. STEREO CHORUS I

Since the two chorus units apply modulation with the opposite phase, the sound seems to shimmer and move in stereo.

20. STEREO CHORUS II

The two chorus units apply modulation with the same phase.

• STEREO CHORUS I

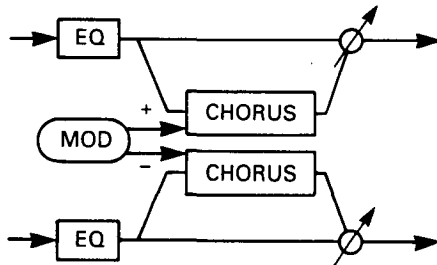

• STEREO CHORUS II

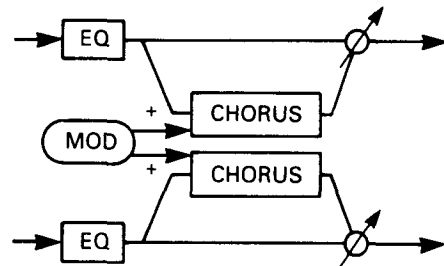

```

PROG A00 P8:EFFECT
-----
FX1 19:Chorus 1 :ON Mod:JS(+Y) I+15
D010 S0.30 M60 TRI L+00 H+00 →60:40
FX2 20:Chorus 2 :ON Mod:VDA-EG I+15
D005 S1.11 M40 SIN L+00 H+00 →60:40
[ SERIAL ] Out3 = OFF Out4 = OFF
    
```

A	B	C	D	E	F	G	H

A D	Delay Time	0 — 200 [ms]	The time from the direct sound to the processed sound
B S	Mod Speed	0.03 — 30 [Hz]	The speed (frequency) of modulation
C M	Mod Depth	0 — 99	The depth of modulation
D	Mod Waveform	SIN (sine) TRI (triangle)	Select the modulation waveform.
F L	EQ Low	-12 — +12 [dB]	The amount of boost or cut for the low frequency range
G H	EQ High	-12 — +12 [dB]	The amount of boost or cut for the high frequency range
H	DRY:FX Balance	DRY, 99:1 — 1:99, FX	The output balance between direct and processed sound

For effects 19 and 20, you can use dynamic modulation to control the Dry:Effect Balance.

21. QUADRATURE CHORUS

This is a stereo chorus in which the modulation is applied to each channel 90 degrees out of phase.

22. CROSSOVER CHORUS

This is a stereo chorus in which the modulation is applied to each channel 90 degrees out of phase, and the chorused signal is mixed into the output of the other channel.

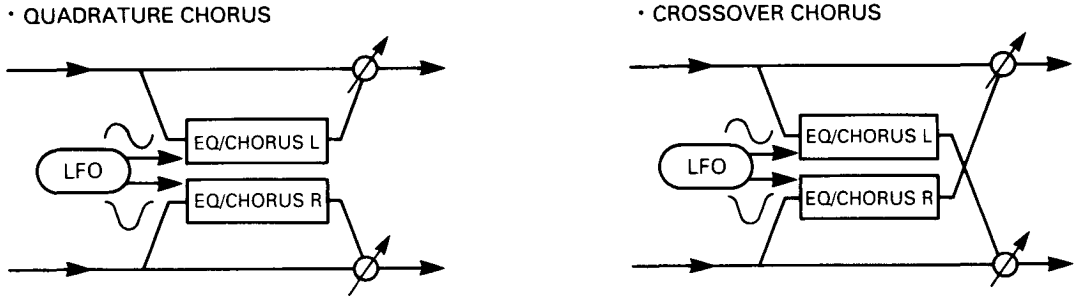

```

PROG A00 P8:EFFECT
FX1 21:Quad. Chorus :ON Mod:JS(+Y) I+15
L011 R023 →S33 D50 T+00 L+00 H+00 50:50
FX2 22:XOver Chorus :ON Mod:VDA-EG I+15
L011 R023 →S33 D50 T+00 L+00 H+00 50:50
[ SERIAL ] Out3 = OFF Out4 = OFF
    
```

A	B	C	D	E	F	G	H

[A] L	Delay Time L	0 — 250 [ms]	The time from the direct sound to the processed sound of the left channel
[B] R	Delay Time R	0 — 250 [ms]	The time from the direct sound to the processed sound of the right channel
[C] S	Mod Speed	1 — 99	The speed of modulation
[D] D	Mod Depth	0 — 99	The depth of modulation
[E]	Mod Shape	T + 10 — T - 10, S - 10 — S + 10	Select the modulation waveform. The number determines the symmetry of the waveform.
[F] L	EQ Low	-12 — +12 [dB]	The amount of boost or cut for the low frequency range
[G] H	EQ High	-12 — +12 [dB]	The amount of boost or cut for the high frequency range
[H]	DRY:FX Balance	DRY, 99:1 — 1:99, FX	The output balance between direct and processed sound

For effects 21 and 22, you can use dynamic modulation to control the Mod Speed.

23. HARMONIC CHORUS

This is a quadrature chorus effect that splits the sound and applies chorusing only to the high range. The low range will not pass through the chorus, and will not be processed. This effect is especially good for low-frequency instruments such as bass.

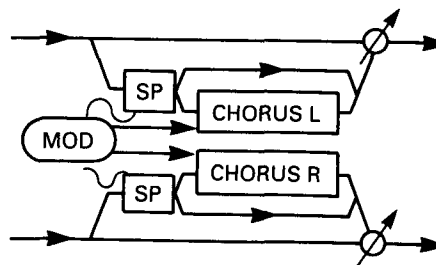

```

PROG A00 P8:EFFECT
-----
FX1 23:Harmonic Cho :ON   Mod:JS(+Y) I+15
DL022 DR046   →S35 D99   FSP01      FX
FX2 23:Harmonic Cho :ON   Mod:VDA-EG I+15
DL022 DR046   →S35 D99   FSP01      FX
[ SERIAL ] Out3 = OFF   Out4 = OFF
    
```

A	B	C	D	E	F	G	H

[A] DL	Delay Time L	0 — 500 [ms]	The time from the direct sound to the processed sound of the left channel
[B] DR	Delay Time R	0 — 500 [ms]	The time from the direct sound to the processed sound of the right channel
[D] S	Mod Speed	1 — 99	The speed (frequency) of modulation
[E] D	Mod Depth	0 — 99	The depth of modulation
[F] FSP	Filter Split Point	0 — 18	The point at which the sound range is split
[H]	DRY: FX Balance	DRY, 99: 1 — 1: 99, FX	The output balance between direct and processed sound

For this effect, you can use dynamic modulation to control the Mod Speed.

SYMPHONIC ENSEMBLE

24. SYMPHONIC ENSEMBLE

This effect is designed to be most effective for ensemble sounds like strings by applying greater modulation in a chorus-type program.

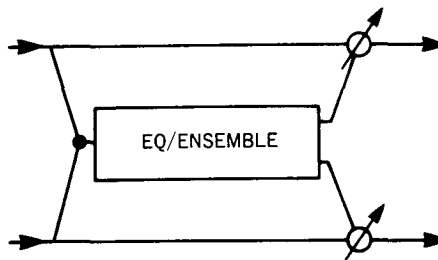

```

PROG A00 P8:EFFECT
-----
FX1 24:Symphonic Ens:ON  Mod:NONE  I+00
M80                      L+00 H+00 +50:50
FX2 24:Symphonic Ens:ON  [Can't Select]
[ SERIAL ] Out3 = L  Out4 = R
-----
  A      B      C      D      E      F      G      H
  [ ] [ ] [ ] [ ] [ ] [ ] [ ] [ ]
    
```

[A] M	Mod Depth	0 — 99	The depth of ensemble effect
[F] L	EQ Low	-12 — +12 [dB]	The gain that cuts or boosts low range components
[G] H	EQ High	-12 — +12 [dB]	The gain that cuts or boosts high range components
[H]	DRY: FX Balance	DRY, 99: 1 — 1: 99, FX	The output balance between direct sound and effect sound

For this effect, you can use dynamic modulation to control the Dry: Effect Balance

* You cannot use the following effects together with the Symphonic Ensemble.

- | | | | |
|---------|--------------------|--------|------------------------|
| 19 — 23 | CHOURS | 38, 39 | CHORUS, FRANGER, DELAY |
| 24 | SYMPHONIC ENSEMBLE | 42 | DELAY/CHORUS |
| 25 — 27 | FLANGER | 43 | DELAY/FLANGER |
| 32, 33 | PHASER | 46 | DELAY/PHASER |
| 34 | ROTARY SPEAKER | 47 | DELAY/ROTARY SPEAKER |
| 35, 36 | TREMORO | | |

FLANGER

These effects add feedback to a chorus effect. When used on sounds that contain a lot of high frequency energy, such as cymbals, they can not only create modulation effects, but also add a sense of pitch to a non-pitched sound.

25. FLANGER I

This is a stereo flanger in which the modulation is applied to both channels in the same phase.

26. FLANGER II

This is a stereo flanger in which the modulation is applied to each channel in the opposite phase, resulting in a wider stereo image and motion.

27. CROSSOVER FLANGER

In this effect, two flangers being modulated in inverse phases apply feedback to each other.

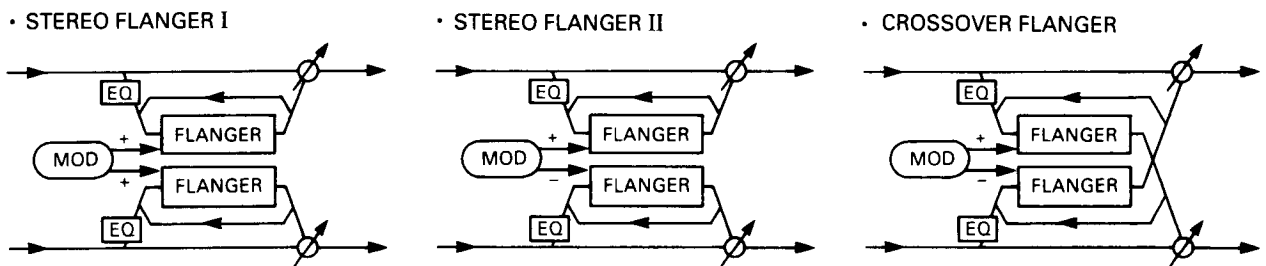

PROG A00 P8:EFFECT

```

FX1 25:Flanger 1 :ON Mod:JS(+Y) I+15
T005 D99 →Speed20 R-85 L+00 H+00 20:80

FX2 26:Flanger 2 :ON Mod:VDA-EG I+15
T010 D99 →Speed20 R+85 L+00 H+00 50:50
[ SERIAL ] Out3 = OFF Out4 = OFF
  
```

A	B	C	D	E	F	G	H

[A] T	Delay Time	0 — 200 [ms]	The time from the direct sound to the processed sound
[B] D	Mod Depth	0 — 99	The depth of modulation
[C]	Mod Speed	1 — 99	The speed of modulation
[E] R	Resonance	-99 — +99	The amount of feedback for the flanger
[F] L	EQ Low	-12 — +12 [dB]	The amount of boost or cut for the low frequency range
[G] H	EQ High	-12 — +12 [dB]	The amount of boost or cut for the high frequency range
[H]	DRY: FX Balance	DRY, 99: 1—1: 99, FX	The output balance between direct and processed sound.

For effects 25 — 27, you can use dynamic modulation to control the Mod Speed.

EXCITER

28. EXCITER

This is an effect that increase the clarity of the sound, gives it greater definition and presence, and helps in bringing the sound to the forefront.

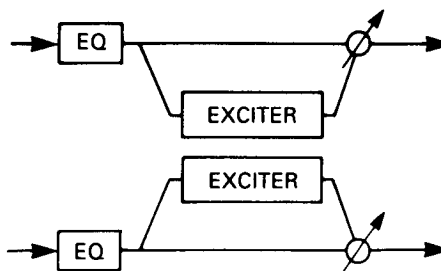

```

PROG A00 P8:EFFECT
-----
FX1 28:Exciter      :ON  Mod:JS(+Y) I+15
B+50      EP05      L+04 H+00 → FX
FX2 28:Exciter      :ON  Mod:VDA-EG I+15
B+50      EP05      L+04 H+00 → FX
[ SERIAL ] Out3 = OFF Out4 = OFF
    
```

A	B	C	D	E	F	G	H

[A] B	Blend	-99 — +99	The depth of exciter effect
[C] EP	Emphatic Point	1 — 10	The central frequency emphasized by exciter
[F] L	EQ Low	-12 — +12 [dB]	The gain that cuts or boosts low range components
[G] H	EQ High	-12 — +12 [dB]	The gain that cuts or boosts high range components
[H]	DRY: FX Balance	DRY, 99 1: — 1:99, FX	The output balance of direct sound and effect sound

For this effect, you can use dynamic modulation to control the Dry: Effect Balance

ENHANCER

This is a two-channel enhancer which includes a delay to give the sound more spaciousness. An enhancer makes the sound clearer and more well-defined, giving the sound more presence and bringing it up front in the mix.

29. ENHANCER

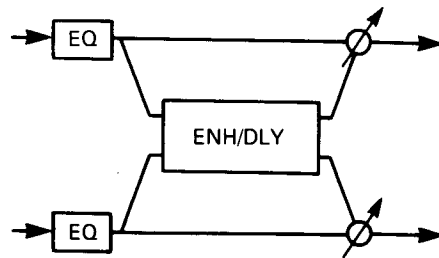

```
PROG A00 P8:EFFECT
```

```
FX1 29:Enhancer :ON Mod:JS(+Y) I+15  
AD80 HS01 SW50 D25 L+01 H+01 → FX
```

```
FX2 29:Enhancer :ON Mod:UDA-EG I+15  
HD80 HS01 SW50 D25 L+01 H+01 → FX  
[ SERIAL ] Out3 = OFF Out4 = OFF
```

A	B	C	D	E	F	G	H

[A] HD	Harmonic Density	1 — 99	The depth of the exciter effect
[B] HS	Hot Spot	1 — 20	The center frequency to which the exciter effect will be applied
[C] SW	Stereo Width	0 — 99	The level at which an inverse-phase delay will be mixed with the output of the other channel
[D] D	Delay Time	1 — 99	The time between the direct sound and the delayed sound
[F] L	EQ Low	-12 — +12 [dB]	The amount of boost or cut for the low frequency range
[G] H	EQ High	-12 — +12 [dB]	The amount of boost or cut for the high frequency range
[H]	DRY:FX Balance	DRY, 99:1 — 1:99, FX	The output balance between direct and processed sound

For this effect, you can use dynamic modulation to control the Dry: Effect Balance.

DISTORTION

30. DISTORTION

This effect distorts the sound and adds a wah effect. It is especially good for solos.

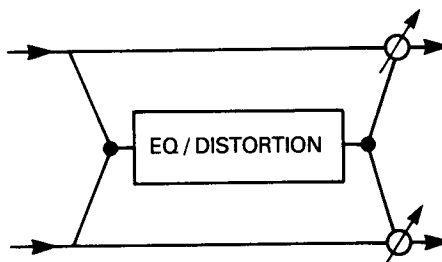

31. OVER DRIVE

This effect simulates the overdrive sound frequently used by guitars. It is effective when playing guitar-like phrases on organ or electric piano sounds, and for solos.

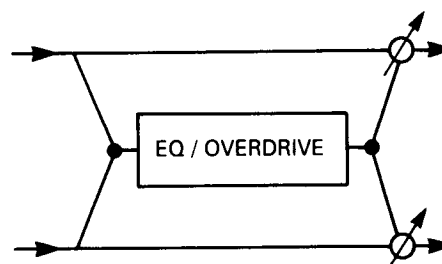

```

PROG A00 P8:EFFECT
-----
FX1 30:Distortion :ON Mod:JS(+Y) I+15
D111 →HS05 R80 L+02 H-12 010 50:50
FX2 31:Over Drive :ON Mod:VDA-EG I+15
D050 →HS45 R00 L+03 H-03 020 50:50
[ SERIAL ] Out3 = OFF Out4 = OFF
    
```

A	B	C	D	E	F	G	H

[A] D	Drive (Edge)	1 — 111	How greatly the input signal will be distorted
[B] HS	Hot Spot	0 — 99	The center frequency for the wah filter
[C] R	Resonance	0 — 99	The Q of the filter (i.e., the amount of wah effect)
[D] L	EQ Low	-12 — +12 [dB]	The amount of boost or cut for the low frequency range
[E] H	EQ High	-12 — +12 [dB]	The amount of boost or cut for the high frequency range
[F] O	Out Level	0 — 99	The output level of the distorted sound
[H]	DRY:FX Balance	DRY, 99:1 — 1:99, FX	The output balance between direct and processed sound

For effects 30 and 31, you can use dynamic modulation to control the Hot Spot in order to obtain a wah effect.

PHASER

These are two-channel stereo phase shifters. Using time delay and changes in phase, they produce a modulation effect that is clearer than chorus or flanger. These effects are especially suitable for electric piano or guitar.

Chorus and flanger produce their effects by modulating the delay time. However, phasers modulate the phase of the input signal, creating an effect that has a different character than chorus or flanger.

32. STEREO PHASER I

Since each phaser block is modulated in inverse phase to the other, the sound image will shift back and forth in stereo.

33. STEREO PHASER II

This stereo-type effect combines two phaser blocks. This effect modulates both phaser blocks with the same phase.

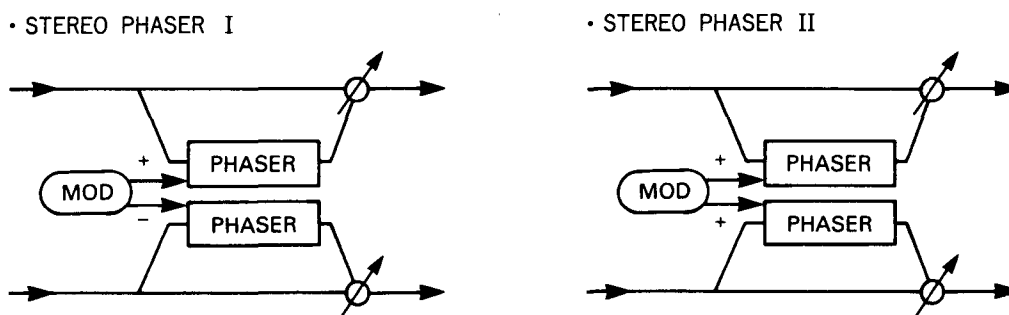

```

PROG A00 P8:EFFECT
FX1 32:Phaser 1 :ON Mod:JS(+Y) I+15
MN99 →50.69M60 F-75 SIN 25:75
FX2 33:Phaser 2 :ON Mod:VDA-EG I+15
MN99 →50.57M69 F+87 TRI 60:40
[ SERIAL ] Out3 = OFF Out4 = OFF
    
```

A	B	C	D	E	F	G	H

[A] MN	Manual	0 — 99	The center frequency to which the phaser shift effect will apply
[B] S	Mod Speed	0.03 — 30 [Hz]	The speed (frequency) of modulation
[C] M	LFO Depth	0 — 99	The depth of the phase shift effect
[D] F	Feedback	-99 — +99 [%]	The amount of feedback (negative settings invert the phase)
[E]	Mod Waveform	SIN TRI	The waveform used for modulation
[H]	DRY:FX Balance	DRY, 99:1 — 1:99, FX	The output balance between direct and processed sound

Effects 32 and 33 allow you to control the speed of Dynamic Modulation.

ROTARY SPEAKER

This effect simulates the rotary speaker effect that is popular for organs.

34. ROTARY SPEAKER

The rotary effect is created by a completely independent LFO. The selected dynamic modulation source can be used to switch between fast and slow speeds. In this case, moving the controller rapidly will not make the rotor speed change in the same way. Rather, regardless of how fast you move the controller, the rotor speed will change to the new speed at the rate specified by Acceleration. Also, the speed can be changed without affecting the intensity of the Dynamic Modulation.

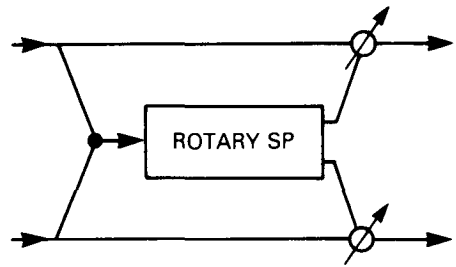

```

PROG A00 P8:EFFECT
FX1 34:Rotary Speakr:ON Mod:JS(+Y) I+15
VIB09 ACC04 SLW25 FST70 FX
FX2 34:Rotary Speakr:ON Mod:VDA-EG I+15
VIB09 ACC04 SLW25 FST70 FX
[ SERIAL ] Out3 = OFF Out4 = OFF
    
```

A	B	C	D	E	F	G	H

A	VIB	Vibrato Depth	0 — 15	The depth of vibrato. This corresponds to varying the horn diameter of the rotating speaker.
C	ACC	Acceleration	1 — 15	The rate at which the speed will change Slow <-> Fast
E	SLW	Slow Speed	1 — 99	The speed when Slow
G	FST	Fast Speed	1 — 99	The speed when Fast
H		DRY:FX Balance	DRY, 99:1 — 1:99, FX	The output balance between direct and processed sound

This effect allows you to control the speed of Dynamic Modulation.

TREMOLO

This effect cyclically varies the volume.

35. AUTO PAN

This is a stereo-type program that combines two tremolo blocks. Since the two blocks are modulated inversely, the stereo image will move as if it were being panned from side to side.

36. TREMOLO

Unlike the Auto Pan above, this effect modulates both tremolo blocks in the same phase.

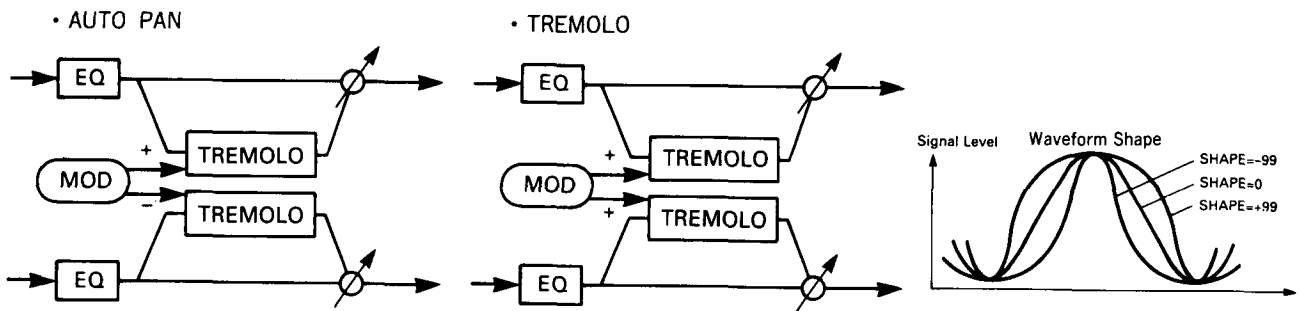

```

PROG A00 P8:EFFECT
FX1 35:Auto Pan :ON Mod:JS(+Y) I+15
SIN S+99 S1.59 M80 L+00 H+00 → FX
FX2 36:Tremolo :ON Mod:VDA-EG I+15
TRI S+00 S04.0 M63 L+00 H+00 → FX
[ SERIAL ] Out3 = OFF Out4 = OFF
    
```

A	B	C	D	E	F	G	H

A	Mod Waveform	SIN TRI	Select the modulation waveform Sine Triangle
B S	Mod Shape	-99 — +99	Change the modulation waveform
C S	Mod Speed	0.03 — 30 [Hz]	The speed (frequency) of modulation (tremolo)
D M	LFO Depth	0 — 99	The depth of tremolo
F L	EQ Low	-12 — +12 [dB]	The amount of boost or cut for the low frequency range
G H	EQ High	-12 — +12 [dB]	The amount of boost or cut for the high frequency range
H	DRY: FX Balance	DRY, 99: 1 — 1:99, FX	The output balance between direct and processed sound

Effects 35 and 36 allow you to use dynamic modulation to control the Dry:Effect balance.

PARAMETRIC EQ

37. PARAMETRIC EQ

This is a three-band equalizer. You can independently adjust the cutoff frequency and gain for the high, middle, and low frequencies.

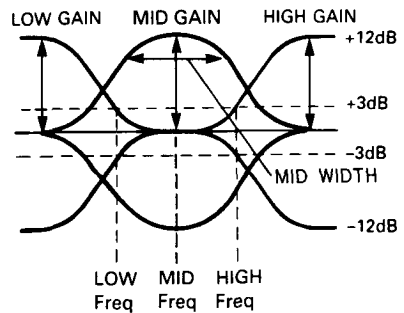
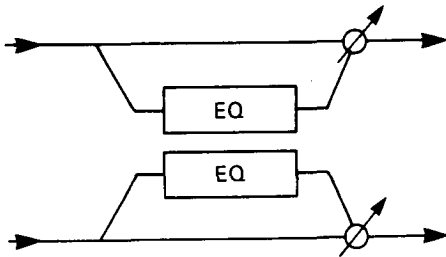

```

PROG A00 P8:EFFECT
-----
FX1 37:Parametric EQ:ON Mod:JS(+Y) I+15
LF12 G+12 →M08 G+12 W50 HF20 G+12 FX
FX2 37:Parametric EQ:ON Mod:VDA-EG I+15
LF12 G+12 →M08 G+12 W50 HF20 G+12 FX
[ SERIAL ] Out3 = OFF Out4 = OFF
    
```

A	B	C	D	E	F	G	H

A LF	Low Freq	0 — 29	The low band cutoff
B G	Low Gain	-12 — +12 [dB]	The amount of boost or cut for the low frequency range
C M	Mid Freq	0 — 99	The center of the mid range filter
D G	Mid Gain	-12 — +12 [dB]	The amount of boost or cut for the mid range filter
E W	Mid Width	0 — 99	The resonance of the mid range filter
F HF	High Freq	0 — 29	The high band cutoff
G G	High Gain	-12 — +12 [dB]	The amount of boost or cut for the high frequency range
H	DRY: FX Balance	DRY, 99: 1 — 1: 99, FX	The output balance between direct and processed sound

This effect allows you to use dynamic modulation to control the Mid Frequency in order to obtain a wah effect.

COMBINATION EFFECTS: SERIAL

In effects 38 and 39, a mono-in stereo-out chorus/flanger is connected in series with a stereo delay.

38. CHORUS-DELAY

In this effect, a mono-in stereo-out chorus with a 90 degree out-of-phase LFO is connected in series with stereo delay.

39. FLANGER-DELAY

In this effect, a mono-in stereo-out flanger with a 90 degree out-of-phase LFO is connected in series with stereo delay.

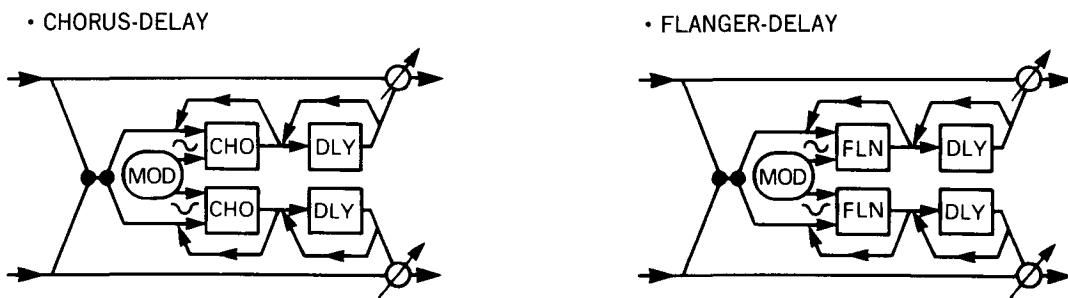

```

PROG A00 P8:EFFECT
-----
FX1 38:Chorus-Delay :ON  Mod:JS(+Y) I+15
T11 FB+10 S30 050 T110 F-10 +70:30

FX2 39:Flanger-Delay:ON  Mod:UDA-EG I+15
T00 FB-90 S10 050 T400 F+60 +50:50
[ SERIAL ] Out3 = OFF Out4 = OFF
    
```

A	B	C	D	E	F	G	H

• CHORUS, FLANGER

[A] T	Delay Time	0 — 50 [ms]	The delay time of chorus or flanger
[B] FB	Feedback	-99 — +99 [%]	The amount of feedback (negative settings invert the phase)
[C] S	Mod Speed	1 — 99	The speed of modulation
[D] D	Mod Depth	0 — 99	The depth of modulation

• DELAY

[E] T	Delay Time	0 — 450 [ms]	The delay time of delay (2ms/1 step)
[F] F	Delay Feedback	-99 — +99 [%]	The amount of feedback (negative settings invert the phase)
[H]	DRY:FX Balance	DRY, 99:1 — 1:99, FX	The output balance between direct and processed sound (chorus, flanger → delay)

For effects 38 and 39, you can use dynamic modulation to control the Dry: Effect Balance.

COMBINATION EFFECTS: PARALLEL

* The effects described from here on (40 - 47) use effects which are combined in parallel placement, allowing you to apply a different effect to each channel. Therefore, you can use different types of effect for EFFECTS 1 and 2.

e.x. In the example below, 40. DELAY/HALL is selected for EFFECT 1, and 43. DELAY/FLANGER is selected for EFFECT 2.

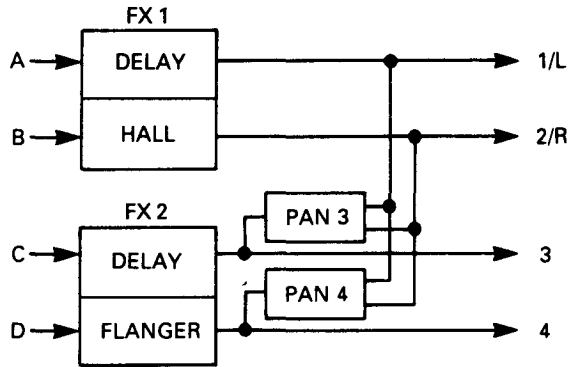

- Please refer sections 1—34 for the contents of effects.
- Items [A] — [D] correspond to the parameters of one effect (Mono Delay), and items [E] — [H] correspond to the parameters of the other effect.

MONO DELAY/REVERB

40. DELAY/HALL

This effect combines a mono delay with a mono hall reverb.

41. DELAY/ROOM

This effect combines a mono delay with a mono room reverb.

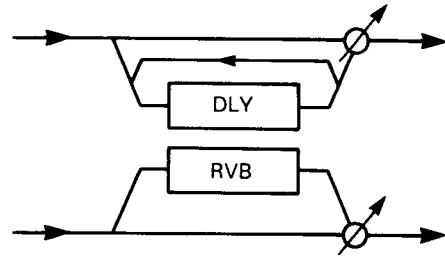

```
PROG A00 P8:EFFECT
```

```
FX1 40:Delay/Hall :ON Mod:JS(+Y) I+15
D250 F+50 HD10→70:30 3.5 D055 HD40→60:40
```

```
FX2 41:Delay/Room :ON Mod:VDA-EG I+15
D250 F+50 HD10→ DRY 1.5 D030 HD30→ DRY
[ SERIAL ] Out3 = OFF Out4 = OFF
```

A	B	C	D	E	F	G	H

• DELAY

A D	Delay Time	0 — 500 [ms]	The delay time of the delay effect
B F	Feedback	-99 — +99 [%]	The amount of feedback (negative values invert the phase)
C HD	High Damp	0 — 99 [%]	Higher values will result in a faster decay for high frequencies
D	DRY:FX Balance	DRY, 99:1 — 1:99, FX	The output balance between direct and processed sound for the delay

• HALL, ROOM

E	Reverb Time	0.2—9.9 [sec] (HALL) 0.2 — 4.9 [sec] (ROOM)	The time after the pre delay over which the reverb will decay
F D	Pre Delay	0 — 150 [ms]	The delay between the direct sound and the first early reflections
G HD	High Damp	0 — 99 [%]	Higher values will result in a faster decay for high frequencies
H	DRY:FX Balance	DRY, 99:1 — 1:99, FX	The output balance between direct and processed sound for the reverb

For effects 40 and 41, you can use dynamic modulation to control the Dry: Effects Balance.

MONO DELAY/MODULATED DELAY

42. DELAY/CHORUS

This effect combines a mono delay with a mono chorus.

• DELAY/CHORUS

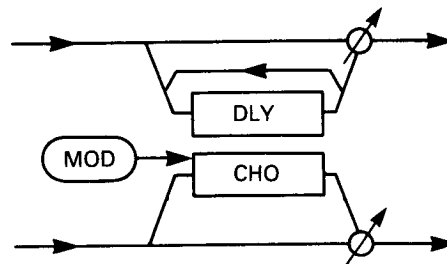

```

PROG A00 P8:EFFECT
-----
FX1 42:Delay/Chorus :ON  Mod:S+J(+) I+15
D250 F+50 HD10→70:30 0.30 M60 TRI→40:60

FX2 43:Delay/Flanger:ON  Mod:PEDAL1 I+15
D250 F+50 HD10→ DRY 0.18 M70 F-75→ DRY
[ SERIAL ] Out3 = OFF Out4 = OFF
    
```

A	B	C	D	E	F	G	H

• DELAY

[A] D	Delay Time	0 — 500 [ms]	The delay time of the delay effect
[B] F	Feedback	-99 — +99 [%]	The amount of feedback (negative values invert the phase)
[C] HD	High Damp	0 — 99 [%]	Higher values will result in a faster decay for high frequencies
[D]	DRY:FX Balance	DRY, 99:1 — 1:99, FX	The output balance between direct and processed sound for the delay

• CHORUS

[E]	Mod Speed	0.03 — 30 [Hz]	The speed (frequency) of modulation
[F] M	Mod Depth	0 — 99 [%]	The depth of modulation
[G]	Mod Waveform	SIN, TRI	Modulation waveform
[H]	DRY:FX Balance	DRY, 99:1 — 1:99, FX	The output balance between direct and processed sound for the chorus

For this effect you can use dynamic modulation to control the Dry: Effects Balance.

43. DELAY/FLANGER

This effect combines a mono delay with a mono flanger.

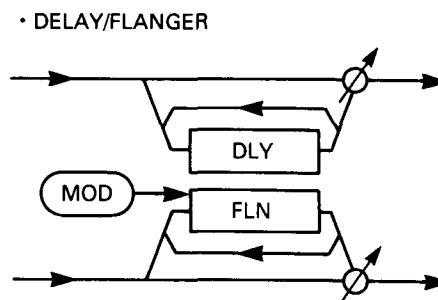

```

PROG A00 P8:EFFECT
-----
FX1 42:Delay/Chorus :ON  Mod:S+J(+) I+15
0250 F+50 HD10→70:30 0.30 M60 TRI→40:60
FX2 43:Delay/Flanger:ON  Mod:PEDAL1 I+15
0250 F+50 HD10→ DRY 0.18 M70 F-75→ DRY
[ SERIAL ] Out3 = OFF Out4 = OFF
    
```

A	B	C	D	E	F	G	H

• DELAY

A	D	Delay Time	0 — 500 [ms]	The delay time of delay
B	F	Feedback	-99 — +99 [%]	The amount of feedback (negative values invert the phase)
C	HD	High Damp	0 — 99 [%]	Higher values will result in a faster for high frequencies
D		DRY:FX Balance	DRY, 99:1 — 1:99, FX	The output balance between direct and processed sound for The delay

• FLANGER

E	Mod Speed	0.03 — 30 [Hz]	The speed (frequency) of modulation	
F	M	Mod Depth	0 — 99	The depth of modulation
G	F	Feedback	-99 — 99 [%]	The amount of feedback (negative values invert the phase)
H		DRY: FX Balance	DRY, 99: 1 — 1: 99, FX	The output balance between direct and processed sound for the flanger

For this effect you can use dynamic modulation to control the Dry: Effects Balance.

MONO DELAY/DISTORTION, OVER DRIVE

44. DELAY/DISTORTION

This effect combines a mono delay with a distortion that includes a wah effect.

45. DELAY/OVER DRIVE

This effect combines a mono delay with an overdrive that includes a wah effect.

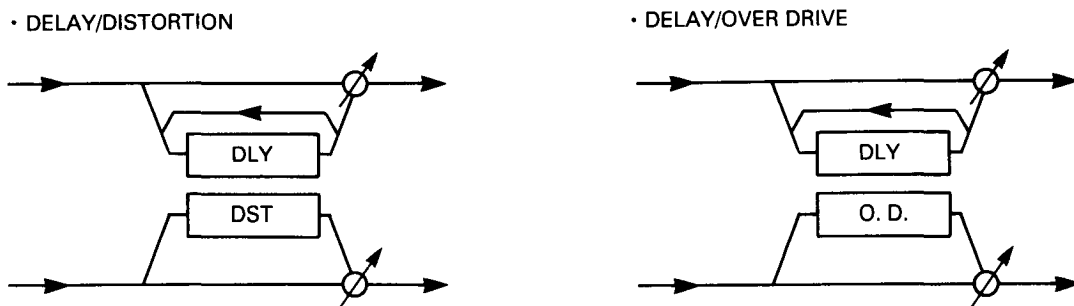

```

PROG A00 P8:EFFECT
-----
FX1 44:Delay/Dist :ON Mod:S+J(+) I+15
DT250 FB+40 60:40 E111 HS50 R75 D05
FX2 45:Delay/OverDrive:ON Mod:PEDAL1 I+15
DT250 FB+40 60:40 E050 HS90 R00 D15
[ SERIAL ] Out3 = OFF Out4 = OFF
    
```

A	B	C	D	E	F	G	H

• DELAY

[A]	DT	Delay Time	0 — 500 [ms]	The delay time of delay
[B]	FB	Feedback	-99 — +99 [%]	The amount of feedback (negative values invert the phase)
[D]		DRY:FX Balance	DRY, 99:1 — 1:99, FX	The output balance between direct and processed sound for the delay

• DISTORTION, OVER DRIVE

[E]	E	Drive (Edge)	1 — 111	How greatly the input signal will be distorted
[F]	HS	Hot Spot	1 — 99	The center frequency for the wah filter
[G]	R	Resonance	0 — 99	The amount of wah effect
[H]	D	Level	1 — 99	The output level of the distorted sound

MONO DELAY/PHASER

46. DELAY/PHASER

This effect combines a mono delay and a mono phaser. This rotary speaker produces a heavier tremolo than the stereo rotary speaker.

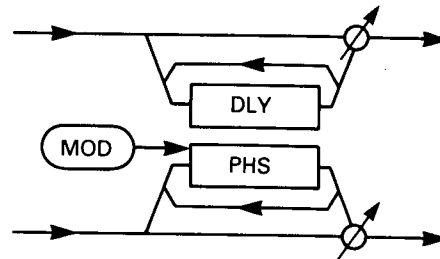

```
PROG A00 P8:EFFECT
```

```
FX1 46:Delay/Phaser :ON Mod:S+J(+) I+15  
0250 F+50 HD10→70:30 0.69 M60 F-75→25:75
```

```
FX2 46:Delay/Phaser :ON Mod:PEDAL1 I+15  
0250 F+50 HD10→ DRY 0.69 M60 F-75→ DRY  
[ SERIAL ] Out3 = OFF Out4 = OFF
```

A	B	C	D	E	F	G	H

• DELAY

[A] D	Delay Time	0 — 500 [ms]	The delay time of delay
[B] F	Feedback	-99 — +99 [%]	The amount of feedback (negative values invert the phase)
[C] HD	High Damp	0 — 99 [%]	Higher values will result in a faster decay for high frequencies
[D]	DRY:FX Balance	DRY, 99:1 — 1:99, FX	The output balance between direct and processed sound for the delay

• ROTARY SPEAKER

[E]	Mod Speed	0.03 — 30 [Hz]	The speed (frequency) of modulation
[F] M	Mod Depth	0 — 99	The depth of modulation
[G] F	Feedback	-99 — +99 [%]	The amount of feedback (negative values invert the phase)
[H]	DRY: FX Balance	DRY, 99: 1 — 1: 99, FX	The output balance between direct and processed sound for the phaser

For this effect, you can use dynamic modulation to control the Dry: Effects Balance.

MONO DELAY/ROTARY

47. DELAY/ROTARY SPEAKER

This effect combines a mono delay with a mono rotary speaker.

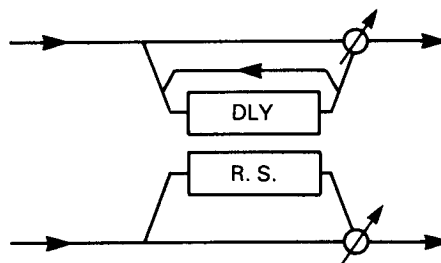

```

PROG A00 P8:EFFECT
-----
FX1 47:Delay/R.SP :ON Mod:S+J(+) I+15
0250 FB+40 60:40 AC04 525 F70 30:70
FX2 47:Delay/R.SP :ON Mod:PEDAL1 I+15
0250 FB+40 60:40 AC04 525 F70 30:70
[ SERIAL ] Out3 = OFF Out4 = OFF
    
```

A	B	C	D	E	F	G	H

• DELAY

[A] D	Delay Time	0 — 500 [ms]	The delay time of delay
[B] FB	Feedback	-99 — +99 [%]	The amount of feedback (negative values invert the phase)
[D]	DRY:FX Balance	DRY, 99:1 — 1:99, FX	The output balance between direct and processed sound for the delay

• ROTARY SPEAKER

[E] AC	Acceleration	1 — 15	The rate at which the speed will change Slow ↔ Fast
[F] S	Slow Speed	1 — 99	The speed of Slow
[G] F	Fast Speed	1 — 99	The speed of Fast
[H]	DRY: FX Balance	DRY, 99: 1 — 1: 99, FX	The output balance between direct and processed sound for the rotary speaker

For this effect, you can use dynamic modulation to change the Rotary Speaker speed.

Effect Parameter

No.	EFFECT	[A]	[B]	[C]
REVERB				
		Reverb Time	Pre Delay	E.R Level
1	Hall	0.2~9.9 [3.2]	0~200 [60]	0~99 [62]
2	Ensemble Hall	// [2.8]	// [40]	// [46]
3	Concert Hall	// [3.8]	// [120]	// [46]
4	Room	0.2~4.9 [1.1]	// [10]	// [75]
5	Large Room	// [2.3]	// [45]	// [60]
6	Live Stage	// [2.0]	// [20]	// [60]
7	Wet Plate	0~99 [60]	// [50]	1~10 [1]
8	Dry Plate	// [40]	// [60]	// [10]
9	Spring Reverb	// [50]	// [0]	// [5]
EARLY REFLECTION				
		E.R Time		Pre Delay
10	Early Reflection 1	100~800 [220]		0~200 [15]
11	// 2	// [200]		// [20]
12	// 3	// [190]		// [10]
STEREO DELAY				
		Delay Time L	Delay Time R	Feedback
13	Stereo Delay	0~500 [250]	0~500 [260]	-99~+99 [-40]
14	Cross Delay	// [180]	// [360]	// [+80]
DUAL MONO DELAY				
		Delay Time L	Feedback L	High Damp L
15	Dual Mono Delay	0~500 [250]	-99~+99 [+50]	0~99 [10]
MULTI TAP DELAY				
		Delay Time 1		Delay Time 2
16	Multi Tap Delay 1	0~500 [300]		0~500 [400]
17	// 2	// [267]		// [400]
18	// 3	// [300]		// [400]
CHORUS				
		Delay Time	Mod Speed	Mod Depth
19	Stereo Chorus 1	0~200 [10]	0.03~30 [0.30]	0~99 [60]
20	// 2	// [5]	// [1.11]	// [40]
CHORUS				
		Delay Time L	Delay Time R	Mod Speed
21	Quadrature Chorus	0~250 [11]	0~250 [23]	● 1~99 [33]
22	Cross Over Chorus	// [11]	// [23]	● // [33]
HARMONIC CHORUS				
		Delay Time L	Delay Time R	
23	Harmonic Chorus	0~500 [22]	0~500 [46]	
SYMPHONIC ENSEMBLE				
		Mod Depth		
24	Symphonic Ensemble	0~99 [80]		
FLANGER				
		Delay Time	Mod Depth	Mod Speed
25	Flanger 1	0~200 [5]	0~99 [99]	● 1~99 [20]
26	// 2	// [10]	// [99]	● // [20]
27	Cross Over Flanger	// [50]	// [99]	● // [50]
EXCITER				
		Blend		Emphatic Point
28	Exciter	-99~+99 [+50]		1~10 [5]
ENHANCER				
		Harmonic Density	Hot Spot	Stereo Width
29	Enhancer	1~99 [80]	1~20 [1]	0~99 [50]
DISTORTION				
		Drive	Hot Spot	Resonance
30	Distortion	1~111 [111]	● 0~99 [5]	0~99 [80]
31	Over Drive	// [50]	● // [45]	// [0]
PHASER				
		Manual	Mod Speed	Mod Depth
32	Stereo Phaser 1	0~99 [99]	● 0.03~30 [0.69]	0~99 [60]
33	// 2	// [99]	● // [0.57]	// [69]
ROTARY SPEAKER				
		Vibrato Depth		Acceleration
34	Rotary Speaker *	0~15 [9]		1~15 [4]
TREMOLO				
		Mod Waveform	Mod Wave Shape	Mod Speed
35	Auto Pan	SIN,TRI [SIN]	-99~+99 [+99]	0.03~30 [1.59]
36	Tremolo	// [TRI]	// [0]	// [4.00]
PARAMETRIC EQ				
		Low Freq	Low Gain	Mid Freq
37	Parametric EQ	0~29 [12]	-12~+12 [+12]	● 0~99 [8]
COMBINATION SERIAL				
		Fig/Cho Delay	Fig/Cho F·Back	Mod Speed
38	Chorus-Delay	0~50 [11]	-99~+99 [+10]	1~99 [30]
39	Flanger-Delay	// [0]	// [-90]	// [10]
COMBINATION PARALLEL				
		Delay Time	Feedback	High Damp
40	Delay/Hall	0~500 [250]	-99~+99 [+50]	0~99 [10]
41	Delay/Room	// [250]	// [+50]	// [10]
		Delay Time	Feedback	High Damp
42	Delay/Chorus	0~500 [250]	-99~+99 [+50]	0~99 [10]
		Delay Time	Feedback	High Damp
43	Delay/Flanger	0~500 [250]	-99~+99 [+50]	0~99 [10]
		Delay Time	Feedback	
44	Delay/Distortion	0~500 [250]	-99~+99 [+40]	
45	Delay/Over Drive	// [250]	// [+40]	
		Delay Time	Feedback	High Damp
46	Delay/Phaser	0~500 [250]	-99~+99 [+50]	0~99 [10]
		Delay Time	Feedback	
47	Delay/Rotary Speaker *	0~500 [250]	-99~+99 [+40]	

D	E	F	G	H
High Damp		EQ Low	EQ High	Dry:FX Balance
0~99 [30]		-12~+12 [-4]	-12~+12 [0]	● DRY~FX [25]
// [32]		// [-1]	// [-2]	● // [30]
// [40]		// [0]	// [-2]	● // [25]
// [20]		// [+3]	// [-2]	● // [32]
// [25]		// [+2]	// [+4]	● // [25]
// [20]		// [+3]	// [0]	● // [40]
// [30]		// [-1]	// [-1]	● // [30]
// [20]		// [+2]	// [+6]	● // [20]
// [30]		// [+3]	// [+4]	● // [20]
		EQ Low	EQ High	Dry:FX Balance
		-12~+12 [+3]	-12~+12 [-5]	● DRY~FX [33]
		// [0]	// [0]	● // [40]
		// [0]	// [0]	● // [40]
High Damp		EQ Low	EQ High	Dry:FX Balance
0~99 [30]		-12~+12 [0]	-12~+12 [0]	● DRY~FX [25]
// [10]		// [0]	// [0]	● // [30]
Dry:FX Balance L	Delay Time R	Feedback R	High Damp R	Dry:FX Balance R
DRY~FX [30]	0~500 [260]	-99~+99 [+50]	0~99 [10]	● DRY~FX [30]
Feedback		EQ Low	EQ High	Dry:FX Balance
-99~+99 [+50]		-12~+12 [0]	-12~+12 [0]	● DRY~FX [50]
// [+50]		// [0]	// [0]	● // [50]
// [+50]		// [0]	// [0]	● // [50]
Mod Waveform		EQ Low	EQ High	Dry:FX Balance
SIN,TRI [TRI]		-12~+12 [0]	-12~+12 [0]	● DRY~FX [40]
// [SIN]		// [0]	// [0]	● // [40]
Mod Depth	Mod Waveform	EQ Low	EQ High	Dry:FX Balance
0~99 [50]	T+10~S+10 [T+O]	-12~+12 [0]	-12~+12 [0]	DRY~FX [50]
// [50]	// [T+O]	// [0]	// [0]	// [50]
Mod Speed	Mod Depth	Filter Split Point		Dry:FX Balance
● 1~99 [35]	0~99 [99]	0~18 [1]		DRY~FX [FX]
		EQ Low	EQ High	Dry:FX Balance
		-12~+12 [0]	-12~+12 [0]	● DRY~FX [50]
	Resonance	EQ Low	EQ High	Dry:FX Balance
	-99~+99 [-85]	-12~+12 [0]	-12~+12 [0]	DRY~FX [80]
	// [+85]	// [0]	// [0]	// [50]
	// [+85]	// [+3]	// [+3]	// [50]
		EQ Low	EQ High	Dry:FX Balance
		-12~+12 [+4]	-12~+12 [0]	● DRY~FX [FX]
Delay Time		EQ Low	EQ High	Dry:FX Balance
1~99 [25]		-12~+12 [+1]	-12~+12 [+1]	● DRY~FX [FX]
EQ Low	EQ High	Out Level		Dry:FX Balance
-12~+12 [+2]	-12~+12 [-12]	0~99 [10]		DRY~FX [50]
// [+3]	// [-3]	// [20]		// [50]
Feedback	Mod Waveform			Dry:FX Balance
-99~+99 [-75]	SIN,TRI [SIN]			DRY~FX [75]
// [-87]	// [TRI]			// [40]
	Slow Speed		Fast Speed	Dry:FX Balance
	1~99 [25]		1~99 [70]	DRY~FX [FX]
Mod Depth		EQ Low	EQ High	Dry:FX Balance
0~99 [80]		-12~+12 [0]	-12~+12 [0]	● DRY~FX [FX]
// [63]		// [0]	// [0]	● // [FX]
Mid Gain	Mid Width	High Freq	High Gain	Dry:FX Balance
-12~+12 [+12]	0~99 [50]	0~29 [20]	-12~+12 [+12]	DRY~FX [FX]
Mod Depth	Delay Time	Feedback		Dry:FX Balance
0~99 [50]	0~450 [110]	-99~+99 [-10]		● DRY~FX [30]
// [50]	// [400]	// [+60]		● // [50]
Dry:FX Balance	Reverb Time	Pre Delay	High Damp	Dry:FX Balance
● DRY~FX [30]	0.2~9.9 [3.5]	0~150 [55]	0~99 [40]	● DRY~FX [40]
● // [30]	0.2~4.9 [1.5]	// [30]	// [30]	● // [40]
Dry:FX Balance	Mod Speed	Mod Depth	Mod Waveform	Dry:FX Balance
● DRY~FX [30]	0.03~30 [0.30]	0~99 [60]	SIN,TRI [TRI]	● DRY~FX [40]
Dry:FX Balance	Mod Speed	Mod Depth	Feedback	Dry:FX Balance
● DRY~FX [30]	0.03~30 [0.18]	0~99 [70]	-99~+99 [-75]	● DRY~FX [60]
Dry:FX Balance	Drive	Hot Spot	Resonance	Out Level
DRY~FX [40]	1~111 [111]	1~99 [50]	0~99 [75]	1~99 [5]
// [40]	// [50]	// [90]	// [0]	// [15]
Dry:FX Balance	Mod Speed	Mod Depth	Feedback	Dry:FX Balance
● DRY~FX [30]	0.03~30 [0.69]	0~99 [60]	-99~+99 [-75]	● DRY~FX [75]
Dry:FX Balance	Acceleration	Slow Speed	Fast Speed	Dry:FX Balance
DRY~FX [40]	1~15 [4]	1~99 [25]	1~99 [70]	DRY~FX [70]

*: "Slow speed" and "Fast speed" can be controlled by the Dynamic Modulation.

4. COMBINATION MODE

In this mode you can select and play Combinations (a combination of Programs), and control other instruments via MIDI. To select a Combination, use the BANK key, the INT/CARD key (01/W), the numeric keys (0 — 9), the ∇/Δ keys, a footswitch (COMBI UP/DOWN) or MIDI program change messages.

- Selections are made from among A00-B99 (internal memory) and C00-D99 (card).
- If you want to select Combinations using a foot switch, set the assignable pedal setting in Global mode to Program Up or Program Down (see page 165).
- When selecting Combinations by MIDI program change messages, set the Global mode parameter MIDI Filter PROG to "ENA".

When set to ENA ... Program change messages received on the global MIDI channel will change Combinations. Program change messages received on other channels will select the Program of the Timbre which is receiving that channel.

If the Timbre channel is the same as the global channel, the global channel will take priority, and the Combination will be changed.

When set to PRG ... Program change messages received on the global channel will not change Combinations, but if a Timbre is receiving that channel, the Program of that Timbre will change.

- The global channel is a MIDI channel set in Global mode P0-3, and it controls the entire 01/WFD•01/W.
- Before selecting a Combination from a card, insert a PROG/SEQ card containing the desired Combination.
- The Timbre mode settings of each Timbre will determine whether or not that Timbre will sound in response to the keyboard or MIDI IN, and whether it will transmit from MIDI OUT according to the Timbre settings.

- Playing the keyboard will sound all Timbres which are set to the same channel as the global MIDI channel (you must first set the Timbre Mode to INT).
- "FX1" or "FX2" will be displayed to the right of the Combination name when the Value slider can be used to control the dynamic modulation of an effect.
- ★ Notes can be played until the total number of oscillators used by all Timbres reaches 32.
- ★ In Combination mode, effect settings for each Program are ignored, and the effect settings specified by the Combination parameters will be used.
- ★ In Edit Combination mode, when a Program is selected for editing, an asterisk "*" will be displayed in front of the Program number. (This will disappear when carrying out a Program Write operation.) If you edit in Program mode or Edit Program mode and then move to the Combination mode, the edited Program will be heard.
- ★ Programs to be used in Combinations from Banks A and B (internal memory) must be selected from Banks A and B as well. Programs to be used in Combinations from Banks C and D must also be selected from Banks C and D. However, if a Bank contains Sequence data, the Program must be selected from the same Bank as that used for the Combination.
- Pressing the COMPARE key while in COMBINATION mode will enable the edit recall function to call up values last set in EDIT COMBINATION mode.

Example:

After creating an orchestra combination in the EDIT COMBINATION mode and then moving to the COMBINATION mode, although a different combination number may be selected, pressing the COMPARE key will leave the new combination number as it is and bring up the orchestra combination from before.

EDITING IN COMBINATION MODE

- In Combination mode, you can modify the Programs assigned to each Timbre of the Combination, and adjust the volume of each Program.
- Press a cursor key ($[A] - [H]$), and use the VALUE slider or the Δ / ∇ keys to edit the value.
- When you edit a Combination in Combination mode, the corresponding Edit Combination mode parameter will also be edited.
- To write a Combination you have edited in Combination mode, use the REC/WRITE key, or the Write operation in Page 9 of Edit Combination mode.
- To move to a lower line, press the CURSOR DOWN key. To move to an upper line, press the CURSOR UP key.

- ☆ By holding a cursor key ($[A] - [H]$) and pressing the EDIT PROG key, you can edit a Program (except effects) used by a Timbre of the Combination, while listening to the Combination. To return, press the COMBI key.

A00 Organ							
T	+	T	+	+	+	+	+
▶Timbre3 A02:Koteki Tai MIDI Ch:03							
A00	B01	A02	P003	P100	P127	OFF	OFF
U127	U051	U117	U082	U104	U099	U000	U064
A	B	C	D	E	F	G	H

PERFORMANCE EDIT

A00 Organ

T	+	T	+	T	+	L	+
▶Timbre3 A02:Koteki Tai MIDI Ch:03 A00 B01 A02 P003 P100 P127 OFF OFF U127 U051 U117 U082 U104 U099 U000 U064							
A	B	C	D	E	F	G	H

P0-1 Program

[A]	Timbre 1 Program	A00 — B99/C00 — D99 P000 — P127	Select the Program for each Timbre
:	:	:	
[H]	Timbre 8 Program	A00 — B99/C00 — D99 P000 — P127	

★ Programs to be used in Combinations from Banks A and B (internal memory) must be selected from Banks A and B as well. Programs to be used in Combinations from Banks C and D must also be selected from Banks C and D. However, if a Bank contains Sequence data, the Program must be selected from the same Bank as that used for the Combination.

• Numbers with “P” indicate a Program change Number. This is displayed when Timbre mode is EXT, and program changes of external MIDI instruments are being controlled.

P0-2 Volume

[A]	Timbre 1 Volume	00 — 127	Adjust the output volume of each Timbre
:	:	:	
[H]	Timbre 8 Volume	00 — 127	

▼ The output volume of each Timbre is shown on the slider display.

5. EDIT COMBINATION MODE

In this mode you can specify how programs are combined into a Combination, and make settings for MIDI OUT.

A Combination consists of 8 Timbres. For each Timbre, it contains a Program, various parameters related to performance and output (panpot, volume, MIDI channel, etc.). A Combination also contains a set of effect parameters that apply to the entire Combination.

- Operations in this mode will edit the Combination you previously selected in COMBINATION mode.
- When you finish editing a Combination, use the Write operation on Page 9 to write your edits into memory. This can also be done by pressing the REC/WRITE button. (If you select another Combination in COMBINATION mode before writing, your edits will be lost.)

☆ In EDIT COMBINATION mode, the numeric keys function as page select keys, but they can also be used together with the cursor keys (**[A]** — **[H]**) to enter parameters.

- While editing, you can press the COMPARE key to hear the un-edited Combination. If you then press the COMPARE key once again without modifying a parameter value, you will return to the Combination you were editing before the COMPARE key was pressed.

☆ While editing P0-3, you can hold a cursor key (**[A]** — **[H]**) and press the EDIT PROG key to edit the corresponding Program while listening to the Combination. To return, press the EDIT COMBI key.

FUNCTIONS IN EDIT COMBINATION MODE

Use the numeric keypad (0 — 9) or the PAGE+ key and PAGE- keys to select pages. To select parameters, use the CURSOR keys (UP, DOWN, **A** — **H**).

PAGE	FUNCTION	Parameter to edit
P0 Timbre 1	0-1 Timbre Mode (T — T8)	The transmit/receive mode of each Timbre being played
	0-2 MIDI Channel (T1 — T8)	The MIDI transmit/receive channel of each Timbre
	0-3 Program (T1 — T8)	The Program assigned to each Timbre
	0-4 Volume (T1—T8)	Volume of each Timbre
P1 Timbre 2	1-1 Transpose (T1 — T8)	Transpose setting of each Timbre
	1-2 Detune (T1 — T8)	Detune setting of each Timbre
	1-3 Panpot (T1 — T8)	Output destination of each Timbre
P2 Window	2-1 Vel Window Top (T1 — T8)	Top velocity value of velocity switch for each Timbre
	2-2 Vel Window Bottom (T1 — T8)	Bottom velocity value of velocity switch for each Timbre
	2-3 Key Window Top (T1 — T8)	Top key of keyboard range played by each Timbre
	2-4 Key Window Bottom (T1 — T8)	Bottom key of keyboard range played by each Timbre
P3 Filter	3-1 Program Change Filter (T1 — T8)	Program Change message reception switch for each Timbre
	3-2 Control Change Filter (T1 — T8)	Control Change message reception switch for each Timbre
	3-3 Damper Switch Filter (T1 — T8)	Damper Switch message reception switch for each Timbre
	3-4 After Touch Filter (T1 — T8)	Aftertouch message reception switch for each Timbre
P8 Effect		Effect settings
P9 Write	9-1 Write Combination	Write a Combination into memory
	9-2 Rename Combination	Rename a Combination
	9-3 Copy Effects All	Copy an Effect
	9-4 Copy/Swap FX	Copy/swap (exchange) settings between effects 1 and 2

For details of Page-8 EFFECT, refer to Effect Parameters (p.49).

EDIT COMBINATION

Page-0 Timbre 1

P0-1 Timbre Mode(T1-T8)
 P0-2 MIDI Channel(T1-T8)
 P0-3 Program(T1-T8)
 P0-4 Volume(T1-T8)

COMBI A00 P0:TIMBRE ▶Timbre Mode							
▶Timbre2 B01:SAX				MIDI Ch:02			
INT	INT	INT	EXT	EXT	EXT	OFF	OFF
01G	02	03	04	05	06	07	08
A00	B01	A02	P003	P100	P127	B06	B07
V127	V051	V117	V082	V104	V099	V000	V064
A	B	C	D	E	F	G	H

P0-1 Timbre Mode

A	Timbre 1	OFF, INT, EXT	Specify the sound and MIDI transmit/receive mode for each Timbre being played
:	:	:	
H	Timbre 8	OFF, INT, EXT	

▼ This parameter specifies the sound and MIDI transmit/receive mode for each Timbre.

- Select OFF for Timbres which are not being used.
- When playing the keyboard, Timbres which have been set to INT will respond, as will those Timbres which are set to the same MIDI channel as the Global channel (see P0-2). Timbres which have been assigned to channels other than the Global channel will respond when MIDI signals are received via the channel selected.

- Performance data is normally transmitted from MIDI OUT on the Global MIDI channel, but if a Timbre used in a Combination is set to EXT, the channel is added to the Global channel, and will also be transmitted via MIDI OUT. In addition, when a change is made in the Combination. Program changes and volume are output, permitting the 01/WFD•01/W to control an external MIDI source as if it were a single Timbre.
- * Timbres which have been set to EXT will not sound.
- * Timbres which are set to EXT should be assigned to a channel other than the Global channel.

P0-2 MIDI Channel

A	Timbre 1	1 — 16	Specify the MIDI transmit/receive channel for each Timbre
:	:	:	
H	Timbre 8	1 — 16	

▼ This parameter specifies the MIDI transmit/receive channel for each Timbre.

- If the Timbre Mode is INT, incoming note, pitch bend, aftertouch, and control change data will be received on the channel specified for each Timbre. The settings in P3-1—4 allow you to enable or disable reception of each type of message. Up to 8 channels of MIDI data can be received to independently play up to 8 Timbres.
- If a channel setting is the same as the Global channel, a «G» will be displayed after the channel number.

- When you play the keyboard, move a controller, or apply aftertouch, messages will be transmitted on the Global channel. Messages will also be transmitted by Timbres whose Timbre Mode is set to EXT, on the channel specified for that Timbre.

When you play the keyboard, the Timbre with a «G» displayed will sound.

P0-3 Program

[A]	Timbre 1	A00 — B99/C00 — D99 P000 — P127	Select a Program for each Timbre
:	:	:	
[H]	Timbre 8	A00 — B99/C00 — D99 P000 — P127	

▼Select a Program for each Timbre.

- If the Timbre Mode is INT, incoming Program Change messages will select Programs for Timbres of the corresponding channel.
- You can specify a Program in the range of A00 — B99 and C00 — D99. However, when the MIDI channel for that Timbre is the Global channel, operations will vary according to the setting selected for MIDI filter “PROG” (see page 159).
- When you select a Combination, Timbres whose Timbre Mode is EXT will transmit a Program Change message from MIDI OUT. You can specify a Program Change number in the range of 000 — 127. However, when the MIDI channel for that Timbre is the Global channel, the Program number for that Timbre will not be transmitted via MIDI OUT.
- Programs to be used in Combinations from Banks A and B (internal memory) must be selected from Banks A and B as well. Programs to be used in Combinations from Banks C and D must also be selected from Banks C and D. However, if a Bank contains no Programs (e.g. no data has been saved in the bank or the bank contains Sequence data), a Program must be selected from the same Bank as that used for the Combination.

- Programs selected for Combinations

- (1) When the Program/Combination are in Banks C/D (Card)

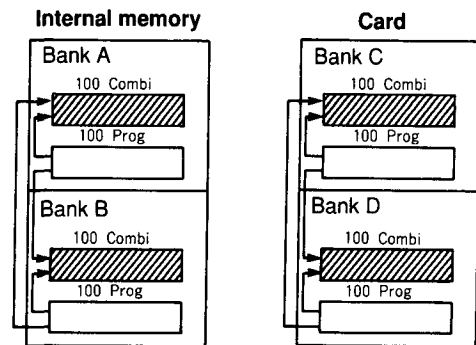

- (2) When Bank C contains Programs and Bank D contains Sequence Data

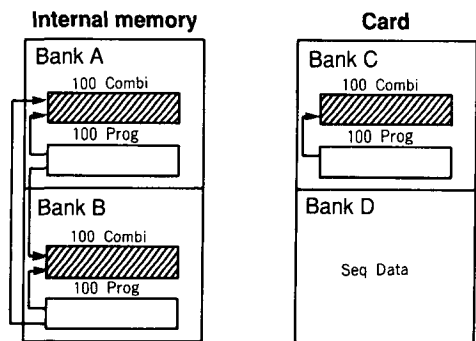

Programs for a Combination in Bank C must be selected from Bank C.

P0-4 Volume

[A]	Timbre 1	00 — 127	Specify the volume for each Timbre
:	:	:	
[H]	Timbre 8	00 — 127	

- ▼Volume specifies the volume of a timbre whose Timbre Mode is set to INT. At a value of 127, the volume will be the full volume as determined by the Program parameters. At a value of 0, that Timbre will not sound.

- When you select a Combination, Timbres whose Timbre Mode is EXT will transmit the specified volume as a MIDI Volume message (Bn.07.xx). However, when the MIDI channel for that Timbre is the Global channel, this will not be transmitted via MIDI OUT.

Page-1 Timbre 2

COMBI A00 P1:TIMBRE ▶PanPot							
▶Timbre5 EXT:100				MIDI Ch:05			
T+00	T+12	T-24	T+05	T+00	T+00	T+00	T+00
D-02	D+00	D+00	D+00	D+00	D+00	D+00	D+00
PRG	A	B	5:5	5:5	5:5	5:5	5:5
A	B	C	D	E	F	G	H

P1-1 Transpose(T1-T8)
 P1-2 Detune(T1-T8)
 P1-3 Panpot(T1-T8)

P1-1 Transpose

[A] T	Timbre 1	-24 — +24	Adjust the pitch of each Timbre in chromatic steps (+/-2 octaves)
:	:	:	
[H] T	Timbre 8	-24 — +24	

▼Transpose adjusts the pitch of each Timbre in chromatic steps over a range of -24 to +24 (12 chromatic steps equals 1 octave).

* For a Timbre whose Timbre Mode is INT, this setting will affect the pitch that is sounded, but not the Note messages that are transmitted from MIDI OUT. For a Timbre whose Timbre Mode is EXT, this setting will affect the Note messages that are transmitted from MIDI OUT.

P1-2 Detune

[A] D	Timbre 1	-50 — +50	Adjust the pitch of each Timbre in steps of 1 cent (+/-50 cents)
:	:	:	
[H] D	Timbre 8	-50 — +50	

▼Detune is a fine pitch adjustment for each Timbre in steps of 1 cent, over a range of -50 to +50 (100 steps equal 1 chromatic step).

* This setting is not transmitted from MIDI OUT.

P1-3 Panpot

[A]	Timbre 1	A, 9:1 — 1:9, B, C, C+D, D, ALL, PRG	Specify the audio output of each Timbre
:	:	:	
[H]	Timbre 8	A, 9:1 — 1:9, B, C, C+D, D, ALL, PRG	

▼Panpot assigns the audio output (= Effects input) of each Timbre to outputs A through D. The audio output of each Timbre can be sent from output A, 9:1—1:9, B, C, C+D, D, ALL, or PRG.

- When ALL is selected, the sound will be output from all outputs A—D. When PRG is selected, the Pan setting of the Program being played by the Timbre will be used. (In Edit

Program mode, you can specify the output for each oscillator.) For settings other than «PRG», oscillators 1 and 2 of the Program will be panned to the same output.

- When a drum kit Program is assigned and “PRG” is selected, the panpot settings of the drum kit will be used. For settings other than “PRG”, the parameter settings will be used.

* The Panpot setting is not transmitted from MIDI OUT.

Page-2 Window

P2-1 Vel Window Top(T1-T8)
 P2-2 Vel Window Bottom(T1-T8)
 P2-3 Key Window Top(T1-T8)
 P2-4 Key Window Bottom(T1-T8)

COMBI A00 P2:WINDOW ▶Vel Window Bottom							
▶Timbre2 B01:SAX				MIDI Ch:02			
064	127	127	127	127	127	127	127
001	064	001	001	001	001	001	001
G9	G9	G9	B3	G9	F#6	G9	G9
C-1	C-1	C-1	C-1	C4	F#2	C-1	C-1
A	B	C	D	E	F	G	H

P2-1 Vel Window Top

[A]	Timbre 1	1 — 127	Specify the maximum velocity that will play each Timbre or be transmitted from MIDI OUT
:	:	:	
[H]	Timbre 8	1 — 127	

P2-2 Vel Window Bottom

[A]	Timbre 1	1 — 127	Specify the minimum velocity that will play each Timbre or be transmitted from MIDI OUT
:	:	:	
[H]	Timbre 8	1 — 127	

▼For Timbres whose Timbre Mode is INT, Velocity Window specifies the range of velocities for which the Timbre will sound. This allows you to make different Programs sound in response to notes of different velocities.

For Timbres whose Timbre Mode is EXT, Velocity Window specifies the range of velocities for which Note messages will be transmitted from MIDI OUT.

- It is not possible to set a Top value lower than the Bottom value.

- Example
 Velocity Window Bottom = 25
 Velocity Window Top = 100

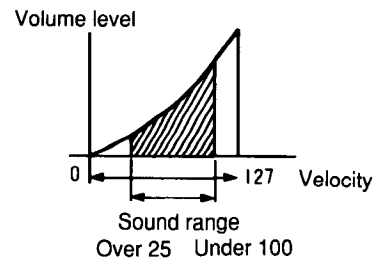

COMBI A00 P2:WINDOW ▶Key Window Top

EXT:003

G9	G9	G9	88	G9				
C-1	C-1	C-1	C-1	C4	F#2	C-1	C-1	

A B C D E F G H

P2-3 Key Window Top

A	Timbre 1	C-1 — G9	Specify the highest note that will play each Timbre or be transmitted from MIDI OUT
:	:	:	
H	Timbre 8	C-1 — G9	

P2-4 Key Window Bottom

A	Timbre 1	C-1 — G9	Specify the lowest note that will play each Timbre or be transmitted from MIDI OUT
:	:	:	
H	Timbre 8	C-1 — G9	

▼For Timbres whose Timbre Mode is INT, Key Window specifies the range of notes for which the Timbre will sound. This allows you to play different Programs over different areas of the keyboard.

For Timbres whose Timbre Mode is EXT, Key Window specifies the range of notes for which Note messages will be transmitted from MIDI OUT.

- It is not possible to set a Top key lower than a Bottom key. If you set the Top key lower than the Bottom key, the Bottom key will automatically be set to the Top key, and vice versa.

- When editing the Key Window, the Key Window setting for each Timbre will be displayed graphically.
- To cancel the display, move the cursor to a parameter other than Key Window.
- You can also use the keyboard to make key settings. While holding the cursor key **A** — **H** underneath the Timbre you wish to edit, press a key, and it will be entered when you release the cursor key.
- When key Transpose is set to 0 in the Global Mode, the 01/W keyboard will correspond to C2-C7.

Page-3 Filter

P3-1 Program Change Filter(T1-T8)
 P3-2 Control Change Filter(T1-T8)
 P3-3 Damper Switch Filter(T1-T8)
 P3-4 After Touch Filter(T1-T8)

COMBI A00 P3:MIDI FLTR▶Program Change							
▶Timbre2 B01:SAX				MIDI Ch:02			
P1:o	P2:o	P3:o	P4:o	P5:o	P6:o	P7:o	P8:o
C1:o	C2:x	C3:o	C4:o	C5:o	C6:o	C7:o	C8:o
D1:o	D2:o	D3:o	D4:o	D5:o	D6:o	D7:o	D8:o
A1:o	A2:o	A3:x	A4:x	A5:x	A6:o	A7:o	A8:o
A	B	C	D	E	F	G	H

P3-1 Program Change Filter

<input type="checkbox"/> P	Timbre 1	x/o	Specify whether or not each Timbre will transmit and receive MIDI program changes
:	:	:	
<input type="checkbox"/> P	Timbre 8	x/o	

▼If the Program Change Filter is set to “x”, that Timbre will not change Programs even when a MIDI program change message is received.

- When you select a Combination, if the Timbre Mode of the Timbres in the newly selected Combination is EXT, the Timbre with the Program Change jFilter set to “o” will transmit the MIDI Program Change message. This will not occur if the Program Change Filter is set to “x”.

- If the “PROG” parameter in the Global mode MIDI Filtering page is set to “ENA”, incoming Program Change messages received on the Global channel will select Combinations, regardless of this setting. However if the “PROG” parameter in the Global mode MIDI Filtering page is set to “PRG”, Combination changes cannot be made, and the Program Change Filter settings made here will be used.

P3-2 Control Change Filter

<input type="checkbox"/> C	Timbre 1	x/o	Specify whether each Timbre will respond to and transmit control changes (joystick, etc.)
:	:	:	
<input type="checkbox"/> C	Timbre 8	x/o	

▼If the Control Change Filter is set to “x”, that Timbre will not be affected by control changes (joystick, foot controller, etc.).

If the Control Change Filter is set to “o” and the Timbre Mode is “EXT”, movements of the joy stick or controllers will be transmitted from MIDI OUT.

P3-3 Damper Switch Filter

[A] D	Timbre 1	x / O	Specify whether each Timbre will respond to and transmit damper pedal messages
:	:	:	
[H] D	Timbre 8	x / O	

▼If the Damper Switch Filter is set to “x”, that Timbre will not respond to the damper pedal.

If the Damper Switch Filter is set to “O” and the Timbre Mode is “EXT”, movements of the damper pedal will be transmitted from MIDI OUT.

P3-4 After Touch Filter

[A] A	Timbre 1	x / O	Specify whether each Timbre will respond to and transmit aftertouch
:	:	:	
[H] A	Timbre 8	x / O	

▼If the After Touch Filter is set to “x”, that Timbre will not respond to aftertouch.

If the After Touch Filter is set to “O” and the Timbre Mode is “EXT”, aftertouch pressure will be transmitted from MIDI OUT.

- When you record data on the sequencer, you can save considerable amount of memory by setting the After Touch Filter to “x” if it is not needed.

Page-8 Effect

For details of the following, refer to “Effect Parameters” (p.49).

- P8-1 Effect 1 Type
- P8-2 Effect 1 Parameter
- P8-3 Effect 2 Type
- P8-4 Effect 2 Parameter
- P8-5 Effect Placement

```

COMBI A00 P8:EFFECT
FX1 01:Hall :OFF Mod:JS(+Y) I+06
3.2 D060 E62 HD30 L+00 H+00 →75:25
FX2 29:Enhancer :OFF Mod:NONE I+00
HD80 HS01 SW50 D25 L+01 H+01 →FX
[ SERIAL ] Out3 = L Out4 = 25:75
    
```

A	B	C	D	E	F	G	H

- Effects selected for Programs in all Timbres are disabled, and the settings made here will be enabled.
- If you wish to use effect settings from a Program or Song, use the Copy Effect operation (P9-3).

- In Combinations, the Pan (A-D) for all Timbres is input to Effect.

Page-9 Write

COMBI A00 P9:WRITE				▶A00:Or9an			
▶Write Combination							
Rename Combination							
Copy Effects All							
Copy/Swap FX							
A00:Or9an				[WRITE] → [E]			
A	B	C	D	E	F	G	H

P9-1 Write Combination

[F]	[WRITE]		Execute writing
[H]		A00 — B99/C00 — D99	The writing destination Combination number

▼This function writes (stores) an edited Combination into internal memory or a RAM card.

- (1) Select the combination number of the writing destination (use cursor key [H]). The name of the Combinations selected at the write destination will be displayed at the top right position.
- (2) Press WRITE (cursor key [F]).
- (3) The display will ask "Are you sure?", so if you are sure you want to write the data into memory, press [YES] (cursor key [E]).
 - The Combination previously in that memory will be lost.
 - To quit without writing, press [NO] (cursor key [H]).
 - Writing is not possible if Combination Memory Protect is On. (Turn memory protect off in GLOBAL mode.)

(4) When the write operation is completed, the display will show "Write Completed".

- Press a cursor key ([A]—[H]) to return to the previous display.

☆To copy a Combination from internal memory into another Combination memory, select the copy source in COMBINATION mode, and use this page to write it into another memory.

☆You can also press the REC/WRITE key to write data without entering this page. In this case, the data will be written into the currently selected Combination.

■01/WFD only: If you wish to write (save) Combination data to disk, use the operation in Disk mode. This will save all 200 Combinations from internal memory to disk.

P9-2 Rename Combination

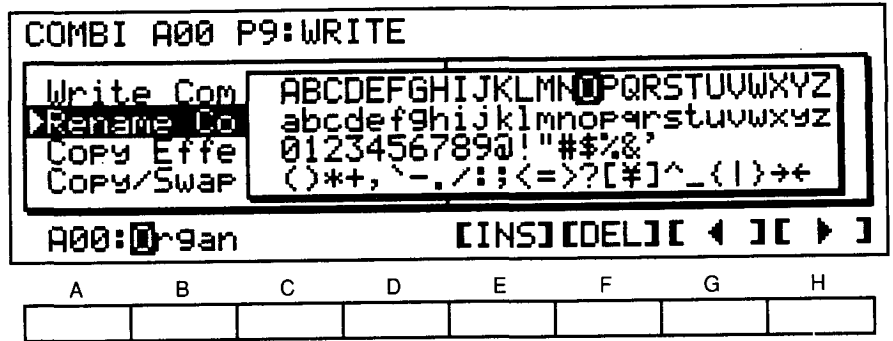

[E]		[INS]	Insert one character at the rename cursor position
[F]		[DEL]	Delete one character at the rename cursor position
[G]		[◀] (cursor left)	Move the rename cursor to the left
[H]		[▶] (cursor right)	Move the rename cursor to the right

Use [◀] (cursor key [G]), [▶] (cursor key [H]), [INS] (cursor key [E]), [DEL] (cursor key [F]), the VALUE slider, and the △ / ▽ keys to modify the Combination name.

Pressing [INS] will insert one copy of the character at the cursor position to the right of the cursor position. Pressing [DEL] will delete the character at the cursor position.

- You may give a Combination a name of up to 10 characters or symbols.

P9-3 Copy Effects All

COMBI A00 P9:WRITE		▶Source Mode	
Write Combination			
Rename Combination			
▶Copy Effects All			
Copy/Swap FX			
from [COMBINATION]		- A00	[COPY]
A	B	C	D
E	F	G	H

[B]	Source Mode	PROGRAM COMBINATION SONG	Copy from a Program Copy from a Combination Copy from a Song
[E]	Source Number	A00 — B99/C00 — D99 A00 — B99/C00 — D99 0 — 9/C0 — D9	The Program to copy The Combination to copy The Song to copy
[G]		[COPY]	Execute the copy operation

■ This function copies only the Effect parameters from a Combination, Program, or Song.

- The data will be copied into the Combination you are currently editing.

(1) Select the type of data containing the memory whose Effect parameters you want to copy ([B]).

(2) Select the memory number you want to copy from. This will be the Program number when copying from a Program, the Combination number when copying from a Combination, or the Song number when copying from a Song.

(3) Press [COPY] ([G]) to copy the effect parameters from the specified memory.

P9-4 Copy/Swap FX

COMBI A00 P9:WRITE		▶Direction	
Write Combination			
Rename Combination			
Copy Effects All			
▶Copy/Swap FX			
FX1 → FX2			[COPY]
A	B	C	D
E	F	G	H

[A]		FX1 → FX2 FX1 ← FX2 FX1 ↔ FX2	Copy FX1 settings to FX2 Copy FX2 settings to FX1 Swap (exchange) settings of FX1 and FX2
[G]		[COPY]	Execute the copy/swap operation

This operation copies (or exchanges) parameter values between Effect 1 and Effect 2.

6. SEQUENCER MODE

HOW A SONG IS ORGANIZED

The 01/WFD•01/W's memory can hold up to 10 Songs. Each Song consists of the following data.

Song

Song parameters (tempo, time signature, etc.)	TRACK 1 parameters (Program number, volume, MIDI channel, etc.)	TRACK 1 musical data
	TRACK 2 parameters	TRACK 2 musical data
	TRACK 3 parameters	TRACK 3 musical data
	TRACK 4 parameters	TRACK 4 musical data
	TRACK 5 parameters	TRACK 5 musical data
	TRACK 6 parameters	TRACK 6 musical data
	TRACK 7 parameters	TRACK 7 musical data
	TRACK 8 parameters	TRACK 8 musical data
	TRACK 9 parameters	TRACK 9 musical data
	TRACK 10 parameters	TRACK 10 musical data
	TRACK 11 parameters	TRACK 11 musical data
	TRACK 12 parameters	TRACK 12 musical data
	TRACK 13 parameters	TRACK 13 musical data
	TRACK 14 parameters	TRACK 14 musical data
	TRACK 15 parameters	TRACK 15 musical data
	TRACK 16 parameters	TRACK 16 musical data

Tempo tracks
(Tracks into which control data is inserted to change the tempo or beat for Tracks 1-16 simultaneously)

EFFECT (effect settings used in this Song)

- Each song contains 16 tracks.
- Each track has its own Program and MIDI channel. (It is also possible to insert program changes at any point in a song.)
- Each track can contain up to 999 measures of musical data.
- Each song has its own effect settings. (In Sequencer mode, the effect settings of the Program assigned to each Track will be ignored.)
- The number of simultaneous notes that the 01/WFD•01/W can produce can not exceed 32 oscillators total for all Tracks.
- Control of external sound sources can be carried out by assigning EXT status to each Track.
- You can select a base resolution (the smallest unit of timing used) of either $\text{♩}/48$ (1/48th of a quarter note) or $\text{♩}/96$. These are referred to respectively as Low Resolution and High Resolution. If you wish to record subtle nuances of timing, you should select High Resolution, but be aware that in this case there are some time signatures (see P0 Beat) which cannot be used.
- Before playing sequence data from a card or disk (01/WFD only), you must first load the data into internal memory.
- A song can be played directly from a card, but no editing or recording can be carried out.
- Among the settings (Track Parameters) used when you start playback, if the Program number, Volume and Pan have been recorded as playback data, the settings for these parameters can be changed during playback.

- ☆ Musical data on tracks in a Song can be created in three ways.
- (1) **Realtime recording (P0-1):** Your keyboard playing will be recorded in the timing that you play it. This is the simplest way to record. When you enter Sequencer mode, you will automatically be in the realtime recording page.
- (2) **Step recording (P5-1):** This allows you to enter notes one by one (a step at a time) from the keyboard, specifying the length and velocity of each note.
- (3) **Pattern (P7-1, P7-2):** Patterns (musical data of 1 — 9 measures) can be strung together to form rhythm parts, etc.

HOW A PATTERN IS ORGANIZED

Pattern

In addition to the 10 Songs, memory also holds 100 Patterns. These Patterns can be arranged in a Track, and played during a Song. It is also possible to use Patterns for repeating sections of a Song, such as rhythm patterns or phrases. This lets you save memory. Each Pattern consists of the following data.

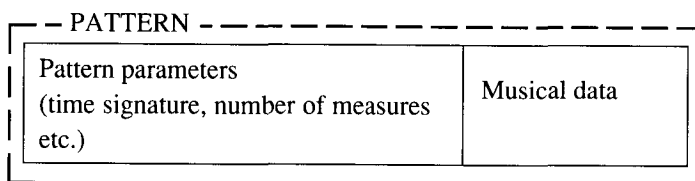

- A Pattern can be placed in any Track of any Song. However, it is not possible to place two or more Patterns in the same measure of the same Track, nor can the same measure contain both a Pattern and other musical data.
- ☆ Pattern data can be created in three ways.
 - (1) **Realtime recording:** Your keyboard playing will be recorded in the timing that you play it. Unlike realtime Track recording, realtime Pattern recording overdubs your playing (the newly played data is added to the old data) as the Pattern continues to repeat. (This allows you to record a drum kit pattern by playing each drum separately.)
 - (2) **Step recording:** This allows you to enter notes one by one (a step at a time) from the keyboard, specifying the length and velocity of each note. Unlike step Track recording, the newly played data is overdubbed (added to the old data).
 - (3) **Copy from a Track:** Musical data can be copied from a Track into a Pattern.

SEQUENCE DATA MEMORY

The sequence memory of the 01/W can contain up to 48,000 steps total for all Songs and Patterns. However, a single Track or Pattern can contain no more than 16,000 steps.

When you turn the 01/W power off, all the sequence data in memory will be lost. Be sure to save your newly created sequence data to disk or card, or use the MIDI data dump to save it to some other external data file.

- The sequence memory of a PROG/SEQ card can contain a total of 7000 steps. Therefore, you can save all the sequence data created on the 01/W. You can also save the sequence data created on the 01/WFD if the free memory space on the 01/WFD is 86% or more.
- When there is enough free memory, you can press the COMPARE key to cancel the previous edit and return the sequence data to its previous condition. For example, if after executing a Quantize operation you decide that you don't like the results, this function allows you to restore the data to its original state.

However, this Compare function applies only to the last-executed operation. While editing a sequence, it is a good idea to save your work to disk (01/WFD only) or RAM card as necessary.

- If there is not enough free memory and the Compare function is not available, the display will ask "Continue?".

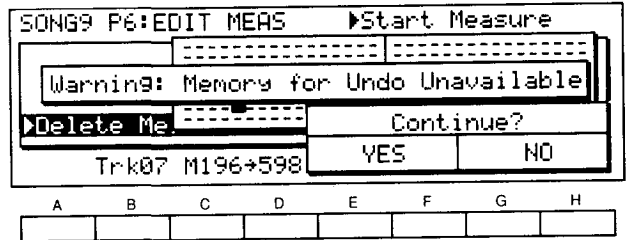

Press YES (**[E]**) to execute the operation. To quit without executing, press NO (**[G]**).

TIME SIGNATURE

The 01/WFD•01/W allows you to specify the beat (time signature) of each measure, but it is not possible for the same measure in two or more tracks to be set to a different time signature. If the time signature of a track is changed as a result of recording or editing, the time signature of the other tracks will change in the same way. Measures that became longer

will have rests inserted into them, and measures that became shorter will no longer play the musical data that extends beyond the new end of the measure. (However since the musical data still remains in the measures, it can be played if the time signature is restored to its original value.)

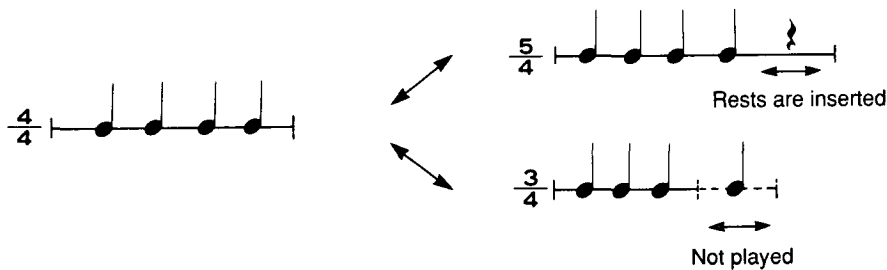

- * The range of beats you can specify will depend on the base resolution.
- Base resolution is the resolution which a song is based on, and is divided into High and Low.

The range of beats on the beat resolution

Base Resolution	Beat
Low	1/4 — 9/4
	1/8 — 16/8
	1/16 — 16/16
High	1/4 — 5/4
	1/8 — 10/8
	1/16 — 16/16

Note: Please note that you cannot change the base resolution of the Song recorded unless you erase the entire Song in P5-7.

FUNCTIONS IN SEQUENCER MODE

Functions in Sequencer mode allow you to play and record a Song, and edit musical data and Song parameters.

- In this mode, the keyboard will play the Program which is assigned to the currently selected Track (i.e., the Track which is selected in P0-1 Track).

PAGE	FUNCTION	
P0 REC/PLAY	0-1 Real Time Recording	Record a Track in realtime
	0-2 Track 1 — 8 Mute/Rec/Play	Mute/record/playback settings for Tracks 1—8
	0-3 Track 1 — 8 Program, Volume, Pan	Specify the Program, Volume and Pan for Tracks 1—8
	0-4 Track 9 — 16 Mute/Rec/Play	Mute/record/playback settings for Tracks 9—16
	0-5 Track 9 — 16 Program, Volume, Pan	Specify the Program, Volume and Pan for Tracks 9—16
P1 TRACK 1 — 8	1-1 Track Status	On/Off, MIDI output for each Track
	1-2 Track Protect	Memory protect On/Off for each Track
	1-3 Transpose	Transpose setting for each Track
	1-4 Detune	Detune setting for each Track
P2 TRACK 9 — 16		Same as P1
P3 Ch, Window 1 — 8	3-1 MIDI Channel	Specify MIDI channel for each Track
	3-2 Velocity Window Top	Specify velocity window for each Track
	3-3 Velocity Window Bottom	
	3-4 Key Window Top	Specify key window for each Track
	3-5 Key Window Bottom	
P4 Ch, Window 9 — 16		Same as P3
P5 EDIT SONG	5-1 Step Recording	Step record a Track
	5-2 Create Control Data	Modify and insert control data in a Track
	5-3 Event Edit	Edit the events in a Track
	5-4 Erase Track	Erase a Track
	5-5 Bounce Track	Bounce a Track
	5-6 Copy Track	Copy a Track
	5-7 Erase Song	Erase a Song
	5-8 Append Song	Append a Song

PAGE	FUNCTION	
P6 EDIT MEASURE	6-1 Quantize 6-2 Shift Note 6-3 Modify Velocity 6-4 Delete Measure 6-5 Erase Measure 6-6 Copy Measures 6-7 Insert Measure 6-8 Put/Copy Pattern	Quantize Shift note data Modify velocity data Delete measures Erase measures Copy measures Insert measures Place/copy a Pattern in/to a measure
P7 EDIT PATTERN	7-1 Real Time Recording 7-2 Step Recording 7-3 Event Edit 7-4 Pattern Parameter 7-5 Erase Pattern 7-6 Get from Track 7-7 Bounce Pattern 7-8 Copy Pattern	Record a Pattern in realtime Step record a Pattern Edit the events in a Pattern Set time signature and length of a Pattern Erase a Pattern Define a Pattern as data from a Track Bounce a Pattern Copy a Pattern
P8 EFFECT		Effect settings
P9 SONG	9-1 Next Song 9-2 Rename Song 9-3 Metronome 9-4 Copy Effects All 9-5 Copy/Swap FX 9-6 Copy from Combination 9-7 Base Resolution	Specify the Song to be played next Set the Song name Metronome settings Copy effect parameters Copy/exchange settings of effects 1 and 2 Copy Combination data Specify the Base Resolution

SEQUENCER

Page-0 REC/PLAY (record/play)

P0-3 Track1~8 Program,Volume,Pan
 P0-2 Track1~8 Mute/Rec/Play
 P0-5 Track9~16 Program,Volume,Pan
 P0-4 Track9~16 Mute/Rec/Play
 P0-1 Real Time Rec/Play

SONG0		SnowGoose				▶Tempo	
*A00	A01	A02	A03	A04	A05	A06	A07
PLAY	PLAY	PLAY	PLAY				
A08	A09	A10	A11	A12	A13	A14	OFF
SNG0 Tr01		M001	4/4	OVWR			
J=144		MAN	Q:HI	M:OFF	Edit:PRG		
A	B	C	D	E	F	G	H

P0-1 Real Time Rec/Play

[A]	SNG	Song	0 — 9	Select the Song to play or record
[B]		Track	1 — 16 MULT	Select the Track to record Specify multitrack recording
[C]	M	Location Measure	001 — 999	Current measure number (location measure)
[D]		Beat	01/04 — 9/04 01/08 — 16/08 01/16 — 16/16 01/04 — 05/04 01/08 — 10/08 01/16 — 16/16 ** / **	Display and set the time signature Low base resolution High base resolution Recording
[E]		REC Mode	OVWR OVDB AUTP MANP LOOP	Select the recording mode Overwrite Overdub Auto punch in Manual punch in Loop (recording mode)
[F]		Rec Start Measure	001 — 999	Measure to start the recording
[G]		Rec End Measure	001 — 999	Measure to end the recording

▼ Song selects the song to be played or recorded. If a card containing sequence data has been inserted, press the BANK key (or the INT/CARD key on the 01/W) to make your selection for playback. Songs you wish to edit or record must first be loaded from a disk or card into the internal memory.

▼ Track specifies the track that will be recorded. When set to a specific track “1 — 16”, the specified track will be recorded. When set to “MULT”, recording will be done in “Multitrack recording” mode, and recording will occur for

all tracks whose REC/PLAY setting is “REC” (see Multitrack Recording).

- When a specific track “1—16” is selected and you play the keyboard, the specified track will sound. At this time, the other tracks with the same MIDI channel assignment will sound simultaneously.
- When “MULT” is selected and you play the keyboard, the track which is assigned to the same channel as the Global channel will sound.

6. SEQUENCER MODE

* The global channel is a MIDI channel which is set in Global mode P0-3, and it controls the entire 01/WFD•01/W.

▼Measure (location measure) indicates the current recording/playback location. After a song has been played back, or when the RESET key has been pressed, this will display "001".

▼Beat specifies the time signature.

By specifying the beat (second row from the bottom **[D]** key) before starting to record, you can specify the time signature the measures will be recorded in. Changes in time signature will apply to all tracks that contain musical data.

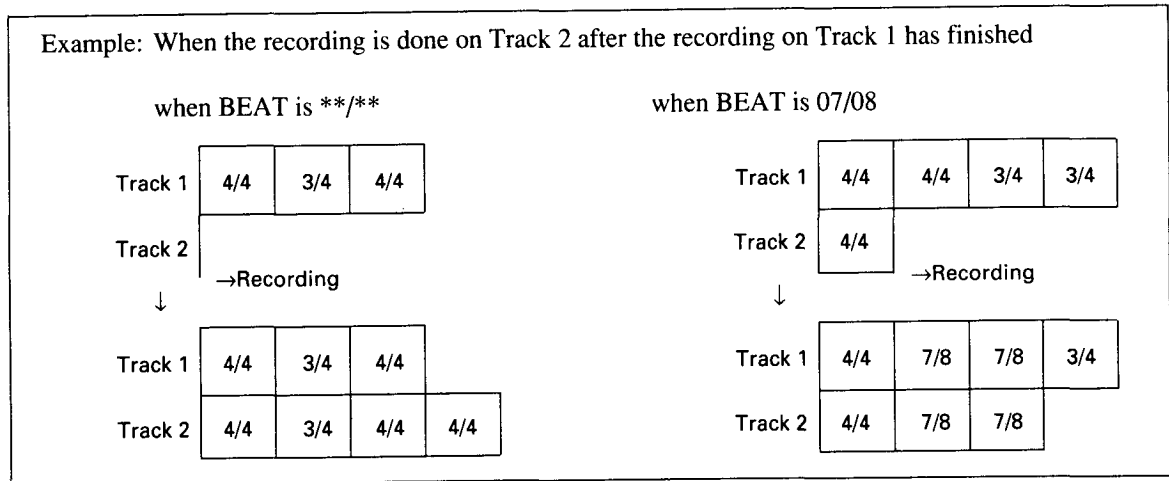

The time signatures that can be selected will depend on the Base Resolution (see Base Resolution P9-7).

- Base resolution is the timing resolution which a Song is based on, and is divided into High and Low.

Low resolution 1/4 — 9/4

1/8 — 16/8

1/16 — 16/16

High resolution 1/4 — 5/4

1/8 — 10/8

1/16 — 16/16

- * It is not possible to make Beat settings during playback.
- * If previously recorded tracks exist, the Beat display during recording will be "**/**". If you begin recording in this condition, the previously recorded time signature will be used, but if you specify a time signature other than "**/**", that time signature will be used for the previously recorded track.

Note: Please note that you cannot change the base resolution of the Song recorded unless you erase the entire Song in P5-7.

▼Recording Mode

Five methods of realtime recording are provided. Use the method that is appropriate for your situation. (Refer to "Realtime Recording" P108)

- The Rec Start Measure and Rec End Measure will be displayed if REC Mode is set to "AUTP" or "LOOP".
- * If you have selected Loop Recording, looping will be carried out during playback as well.

[A] ♩ =	Tempo	40 — 240 EXT	Tempo when clock source is INT (number of beats per minute) When clock source is EXT
[B]	Tempo Track	MAN, AUT MAN, AUT, REC	Normally, during playback When the REC/WRITE key is pressed
[C] Q	Realtime Quantize	HI, ♩ ₃ , ♩, ♩ ₃ , ♩, ♩ ₃ , ♩, ♩	Rhythm correction step while recording (realtime quantization)
[D] M:	Metronome	OFF ON REC	Specify how the metronome will sound The metronome will not sound The metronome will sound during both recording and playback The metronome will sound only during recording
[E]	Edit Parameter	PRG VOL PAN	Select the parameter you wish to edit in this page Program number Volume Panpot
[G]	Add/Remove	[ADD] [RMV]	Add or remove musical data
[H]	Erase	[ERA]	Partially erase performance data

▼Tempo displays and adjusts the playback tempo.

- When the Global mode P0-3 “Clock Source” is set to “INT”, the current tempo will be displayed if the Tempo Track is set to «AUT» when playing back or when the measure is changed. (You cannot use the Value Slider or Δ/∇ key to edit). The Tempo Track can be edited when “MAN” is selected.
- When the Global mode P0-3 “Clock Source” is set to “EXT”, the Tempo display will be “EXT”. The tempo will be determined by clock messages from an external sequencer, etc.

▼The Tempo Track registers data to control the tempo during a song.

When recording, this can be set to MAN (manual), AUT (auto), or REC (record). If you modify the tempo when this is set to “REC”, the tempo changes will be recorded into the tempo track. When set to “AUT”, the tempo will change according to the tempo changes that were recorded, and you can record as the tempo changes.

When playing back, this can be set to MAN or AUT. When “MAN”, the tempo will not change. When “AUT”, the recorded tempo changes will control the tempo.

▼Realtime Quantize

Realtime Quantize (bottom line [B] key) determines the timing accuracy to which data will be corrected as you

realtime record. If you set this to “HI”, data will be recorded at the timing set in the Base Resolution (P9-7), and if this is set to ♩, data will be recorded at quarter note intervals. If control data for which the value is constantly changing (such as pitch bend) is recorded at a rough resolution (such as ♩), it will have an unnatural “stepped” effect when played back. In such cases, record using as fine a resolution as possible, and then use P6-1 Quantize to correct the timing of note data.

▼Metronome

OFF: the metronome will not sound

REC: the metronome will sound during recording but not during playback

ON: the metronome will sound during both recording and playback

* When the metronome is used, the number of available voices will decrease by one.

▼Edit Parameter allows you to select either “Program No.”, “Volume”, or “Panpot” as the parameter to be edited in that screen. If you edit these while recording, your edits will be recorded, allowing you to insert Program Change, Fade In, Fade Out or panning data in realtime.

▼[RMV] Remove and [ERA] Erase will be displayed if REC Mode is set to “Loop”.

* See “Loop Recording”, P112, for Rec Start Measure, Rec. End Measure, Add/Remove, and Erase.

P0-2 Track 1 — 8, Mute/Rec/Play

[A]	Track 1	PLAY MUTE REC PLAY MUTE	Playing Muted Recording Playing Muted	During playback During recording
:	:	:		
[H]	Track 8			

▼Specify the Mute/Rec/Play mode of each track 1 — 8

- During playback, tracks set to PLAY will be played, and tracks set to MUTE will not be played.
- When carrying out single track recording (Tracks 1-16), select REC for the track to be recorded, and other tracks which have data to PLAY or MUTE.
- When carrying out multi-track recording (select MULTI), REC or "—" will appear for tracks which contain no data, and for tracks which do contain data, select REC, PLAY or MUTE.
 - : Track is not used (contains no data)
 - REC : Track is used for recording
 - PLAY : Track is played back
 - MUTE : Track is not played (contains data)

- During playback, press a key 0-3 while holding down any key [A]—[H] that corresponds to the track you have selected. The following settings may be selected.
 - 0 : The track(s) will be played.
 - 1 : The track(s) will be muted.
 - 2 : All tracks will be played.
 - 3 : All tracks other than the one selected will be muted (Solo function).

P0-3 Track 1 — 8 Program, Volume, Pan

[A]	Track 1	OFF, A00 — A99, B00 — B99 00 — 127 A, 9:1 — 1:9, B, C, C+D, D, ALL, PRG	Program number Volume Pan
:	:	:	
[H]	Track 8		

▼This determines the Program, Volume, and Pan settings for each Track 1 — 8. Edit Parameter ([E] key in the bottom line) determines whether Program, Volume, or Pan will be set.

- If changes are made in the Program, Pan or Volume settings of a track during recording, those changes will be recorded along with the note data and the control data.
- If changes are made during playback, they will be stored as track parameters, and the new settings will be selected when Reset Start (playback from the beginning) is used for playback. However, if these changes result in parameters which are the same as some other parameters already recorded on that track, no changes will be made.

For example, the Volume parameter for a track is set to 127 and a song which contains data setting the Volume to 100 in the 10th measure is played. At some point prior to playback of the 10th measure, the Volume parameter is changed to 110, so the next time the song is played the track will start playback at 110, the new Volume parameter.

However, when the song reaches the 10th measure, the data in that measure will adjust the Volume parameter to 100. After this change, no further adjustments will be made in the value of the Volume parameter during playback from the 10th measure forward.

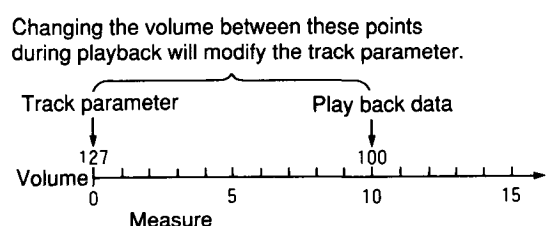

- If a Track contains program change, volume control, or pan change data, the display will change independently during playback and when the measure is changed.

- When a Track's pan setting is "PRG", the pan setting of the Program selected for that track will be used. This means that if that Program is a Drum Kit, the pan settings of the inst of the drum kit will be used.
- When any setting other than PRG is selected, a single pan will be used for Oscillators 1 and 2, even if the OSC mode for the Program is set to Double. The output (= effects input) will be transmitted from this setting. The DRUMS setting in the OSC mode also works in this manner.
- * When a Pan setting is changed during playback or recording, the newly selected pan will be enabled with the next note played following the change. Pan settings cannot be changed for a sound while it is being played.

P0-4 Track 9 — 16, Mute/Rec/Play

[A]	Track 9	PLAY MUTE REC PLAY MUTE	Playing Muted Recording Playing Muted	During playback During recording
:	:	:		
[H]	Track 16			

▼Specify the Mute/Rec/Play mode of each track 9 — 16. The content is the same as P0-2.

P0-5 Track 9 — 16 Program, Volme, Pan

[A]	Track 9	OFF, A00 — A99, B00 — B99 00 — 127 A, 9:1 — 1:9, B, C, C+D, D, ALL, PRG	Program number Volume Pan
:	:	:	
[H]	Track 16		

▼This determines the Program, Volume, and Pan settings for each Track 9 — 16. The content is the same as P0-3.

Play

Specify the Song number (second row from the bottom **[A]** key) to play, and press START/STOP to begin playback. Insert a PROG/SEQ card containing sequence data and press the BANK key (or the INT/CARD key on the 01/W) to select a song from the card. To playback from a specific location in the song, specify the location measure (second row from the bottom **[C]** key). During playback, pressing START/STOP will pause playback. Press START/STOP once again to resume playback.

When the song ends, playback will stop and the measure will be reset to 001. However if P9-1 Next Song has been specified, that song will be selected.

- If playback was started from the middle of a song, the position will be reset to the measure at which playback was started when the song ends.
- While not playing back, pressing the RESET switch will return to the beginning of the song, and all settings will change to the initial track parameter values. The Bank, Program Number, Volume, and Pan settings for tracks with a status of "EXT" or "BOTH" will be transmitted via MIDI OUT.

- Effect settings can be changed even during playback by moving to Page 8 and making your selection.

* Beat settings cannot be made during playback.

- During playback, you can set P0-2 and P0-4 REC/PLAY mode to "MUTE", to mute the playback of a track.
- * When the tempo (the **[A]** key in the bottom line) is "EXT", playback will not begin if you have not input a MIDI clock when you press the START/STOP key, since it will be controlled from an external MIDI device. If you set the Global mode parameter P0-3 "Clock Source" to "INT", the tempo display will show a number value, and you will be able to start playback by pressing the START/STOP key.
- When a change is made in the Program, Volume or Pan settings during playback or when stopped, the value is written as a new track parameter (initial value) with each change that is made.

About realtime recording

There are five ways to realtime record. "P0-1 Rec Mode" specifies the recording method.

Over Write	overwrite
Over Dub	overdub
Auto Punch In	auto punch in
Manual Punch In	manual punch in
Loop	loop

• Over Write Recording

Press the REC/WRITE key and then press the START/STOP key to begin recording. To stop recording, press the START/STOP key once again. This is the most basic form of recording.

If you overwrite record on a track which already contains musical data, the data will be rewritten and the data following the point at which you began recording will be erased.

• Over Dub Recording

If you overdub record into a track which already contains musical data, the newly recorded data will be combined with the previous data.

• Auto Punch In Recording

This method of recording allows you to re-record a specified area (specified measures) of a previously recorded track.

• Manual Punch In Recording

This method of recording allows you to playback a previously recorded track, and press the REC/WRITE key or a pedal to re-record only as long as the pedal is pressed.

• Loop Recording

This method of recording repeatedly plays back a specified area (specified measures), and allows you to continue recording additional data (or deleting data) in that area.

☆ Sequence data cannot be recorded or edited directly from a card. The data must first be loaded into the internal sequence memory.

Pattern opening

If there is a Pattern which has been put into a specified measure in Put Pattern (P6 — 8), in the range specified in the Source/ Destination Track of the Bounce Track or Edit Measure, the following message will be shown when the recording or editing has finished.

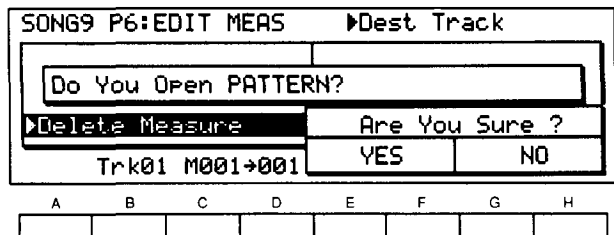

Selecting “Yes” will have the same result as when the Pattern was copied onto the Track when the Pattern was copied in P6-8. This is the same result as that obtained when editing in the Bounce Track or Edit Measure has finished.

In other words, “Pattern opening” means that the Pattern put into the measure will be copied onto the Track. This operation does not affect the Pattern.

Selecting “No” will cancel the Put Pattern. (Data will be erased from measures in which the Pattern of the corresponding Track has been Put.)

There may be some cases where the error message is displayed and you cannot execute Edit depending on the type of Edit (see page 211).

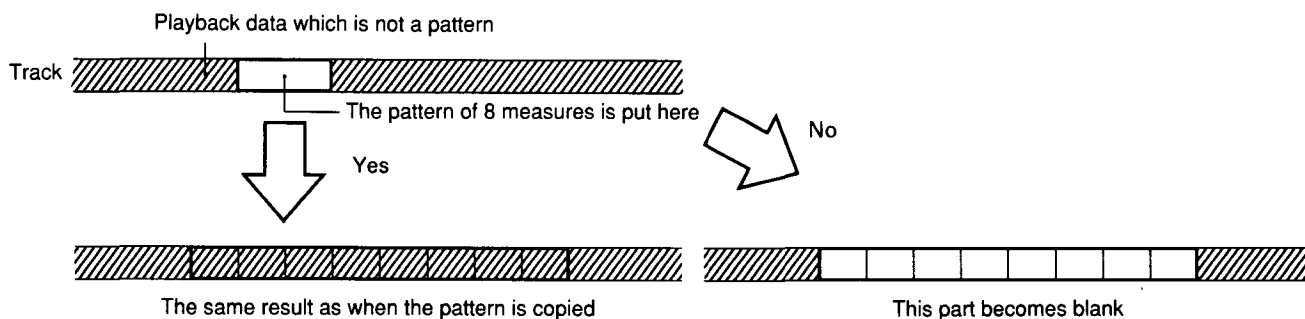

If there is a Pattern in the range where Recording has been done using Real Time Recording mode, the Pattern is opened automatically when recording is finished. However, the following message will be displayed if there is not enough memory space.

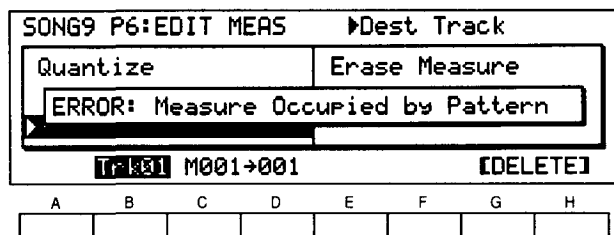

Pressing “Yes” will lead to the same result as selecting “No” for the above “Do You Open Pattern?”. Pressing “No” will cancel the recording and editing operation.

Realtime recording procedure

- (1) Select the song you wish to record (second line from the bottom **[A]** key), and then specify the P9-7 Base Resolution. This can be set independently for each song. However, be aware that once the Base Resolution has been set, it cannot be modified until you erase the song data (P5-7 Erase Song).
- (2) Select the track you wish to record (second line from the bottom **[B]** key), and if necessary, use P1 — 4 to specify parameters (output destination and MIDI channel of the musical data, etc.). At this time, set P1-2 (P2-2) Protect to “OFF”. (If this is “ON”, recording will not be possible.)
- (3) Press the REC/WRITE key to make the indicator light.
- (4) Specify the Beat (second line from bottom **[D]** key) and Tempo (bottom line **[A]** key). These parameters can be set independently for each song, and playback will begin with the settings you specify. If necessary, make settings for the basic parameters related to the tempo, Quantize value, Metronome ON/OFF, and so on using Tempo Track (bottom line **[B]** key), Realtime Quantize (bottom line **[C]** key), and Metronome (bottom line **[D]** key).
- (5) Press Edit Parameter (bottom line **[E]** key), and in P0-3 and P0-5, specify the Program number, Volume, and Panpot for the track you will be recording. If you modify these settings during recording, your changes will be recorded. If desired, make settings when you start recording.
- (6) Select the recording mode (second line from bottom **[E]** key). After this step, the procedure will depend on the type of recording, so refer to the explanations of each recording mode.
 - Aftertouch data uses up a lot of memory. When recording a Track which does not require aftertouch data, save memory by setting the Global mode P0-5 MIDI Filter setting for Aftertouch to “DIS”.

Overwrite Recording

Follow steps (1) — (5) of the “Realtime recording procedure”, and select “OVWR” in step (6).

- (7) Press START/STOP. After the countdown specified by P9-3 Lead In, recording will begin. At this time, other tracks will be played according to the P1-1 (P2-1) Track Status setting.

- (8) When you are finished, press START/STOP to stop recording. You will return to the measure at which recording began, so you can press START/STOP to hear the performance you just recorded.

* Overwrite Recording on the Track where the Pattern has been Put will automatically cancel the Put pattern, and new data will be recorded on the Track.

Overdub recording

The recording procedure is the same as for “Overwrite recording”. (Select “OVDB” in step (6).)

* In the Overdub recording on the Track in which the Pattern has been put, the display will ask you if you want to open the Pattern. Selecting and “Yes” will open the Pattern on the Tracks and Selecting “No” will cancel the Put Pattern.

Auto Punch In recording

Auto Punch In recording allows you to re-record a specified measure of a Track.

Perform steps (1) — (5) of “Realtime recording”, and select “AUTP” in step (6).

- (7) Specify the Rec start measure (second from the bottom row **[F]** key) and the Rec End measure (second from the bottom row **[G]** key).
- (8) Set the location measure (second row from the bottom **[C]** key) to a location several measures before the Rec start measure, and press START/STOP. After a count-down to the measures specified on P9-3 Lead In, playback will begin.
- (9) When the Rec start measure is reached, recording will automatically begin.

- (10) When the Rec end measure is reached, press START/STOP to stop playback. You will return to the measure at which playback began. To punch in record to the same measure once again, repeat from step (8).

- If the specified punch in/out area contains damper or pitch bend data, the loss of this data may result in a “stuck” or different effect of damper pedal or pitch bend when played back. If so, use Create Control Data or event edit to correct the data.

- * In the Auto Punch In recording on the Track onto which the Pattern has been put, the display will ask you if you want to open the Pattern. Selecting “Yes” will open the Pattern on the Track, and selecting “No” will cancel the Put Pattern.

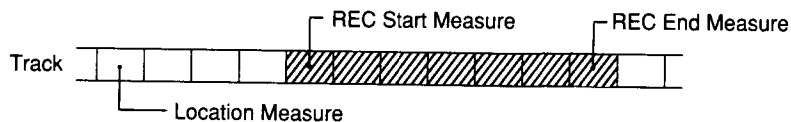
**Manual punch in recording**

Perform steps (1), (2), (4), and (5) of “Realtime recording” (not (3)), and select “MANP” in step (6).

- (7) Set the location measure (second row from the bottom **[C]** key) to a location several measures before the area you wish to re-record, and press START/STOP to begin playback.
- (8) When you reach the beginning of the area you want to re-record (the punch-in point), press the REC/WRITE key or press a foot switch (the assignable pedal for which you select “SEQ Punch In/Out” in Global mode P4-2(3)). The REC/WRITE key will light, and recording will begin.
- (9) When you reach the end of the area you wish to record (the punch-out point), press the REC/WRITE key once again, or press the footswitch. Recording will end.

- If the specified punch in/out area contains damper off or pitch bend data, the loss of this data may result in a “stuck” damper pedal or pitch bend when played back. If so, use Create Control Data or event edit to correct the data.
- * This method of recording is used to make corrections to existing data. The previously specified beat will be used, and cannot be set here.
- * In the Manual Punch In recording on the Track in which the Pattern has been Put, the display will ask you if you want to open the Pattern. Selecting “Yes” will open the Pattern on the Track, and selecting “No” will cancel the Put Pattern.

Loop Recording

In this method of recording, the specified area of measures will be played back repeatedly, and you can record additional data while listening to the previously recorded data play back.

Perform steps (1) — (5) of “Realtime recording”, and select “LOOP” in step (6).

- (7) Specify the Rec start measure (second from the bottom row **[F]** key) and the Rec end measure (second from the bottom row **[G]** key).
- (8) Set the location measure (second row from the bottom **[C]** key) to a location several measures before the Rec start measure, and press START/STOP. After a count-down to the measures specified on P9-3 Lead In, playback will begin.
- (9) When the Rec start measure is reached, recording will automatically begin.
- (10) When the Rec end measure is passed, playback will immediately begin again from the Rec start measure, and you can continue recording. The newly recorded data will be overdubbed.

* In Loop recording, there are two ways in which you can erase data.

- After starting the recording, press [ERA] (**[H]**), and all sequence data during the time you press the key will be erased.

- After starting, select “RMV” for Add/Remove (**[G]**). Press the key you wish to erase, and data for that note will be erased from the pattern as long as you hold the key down. While you use the joystick to apply an effect such as pitch bend, that control data will be erased.

(11) When you press the START/STOP key, recording will stop. If you start without pressing the REC/WRITE key, you will hear the data you just recorded. If you wish to modify or erase the data further, repeat steps (8) — (11).

* If you record data onto the area which indicates the Pattern which has been Put on the Track, the Put Pattern will be automatically cancelled, and new data will be recorded on the Track.

Multi-track recording

The 01/WFD•01/W can also record MIDI data from external devices. When the Track selection (second row from bottom **[B]** key) is set to a single track “Trk1”—“Trk16”, only MIDI data which matches the channel specified for that Track will be recorded (single track recording). However, if a Track (C2) is set to “MULT”, several Tracks can simultaneously record data on the corresponding MIDI channels.

* Multi-track recording involves receiving data from an external source such as a MIDI sequencer. Because of this, the clock source should be set to EXT in order to be in synch with the external MIDI device.

- (1) Specify the P3-1 (P4-1) Track MIDI Channel for each Track.
- (2) Set Track (second row from bottom **[B]** key) to “MULT”.
- (3) Set P0-2 and P0-4 Track REC/PLAY to “REC” for each Track you want to record. (Tracks you do not wish to record should be set to “———”, and Tracks you wish to play back should be set to “PLAY”.)

Synchronization with external MIDI devices

External rhythm machines or sequencers can be connected via MIDI to play back in synchronization with the 01/WFD•01/W. Set the clock (timing) source of the master unit (the device operations controlling operations) to Internal (transmit MIDI clock messages), and the slave unit (the device being controlled) to External (synchronize to incoming MIDI clock messages), and connect the master unit’s MIDI OUT to the slave units’ MIDI IN.

- Specify the clock source of the 01/WFD•01/W in Global mode (P0-3). (The operating manual of your other unit will tell you how to set its clock source.)

- (4) Follow the procedure for Realtime Recording.

- If the amount of MIDI data on each channel is uneven, a memory full error may occur even though not all memory has been used up. In such cases, record without the largest track, and then re-record this track later.
- The following messages received at MIDI IN will be recorded; note on/off, pitch bend, program change, channel pressure, poly key pressure, and control change (0 — 101).
- ☆ Multi-track recording and Loop recording cannot be carried out together.
- “PLAY” is shown in the REC/PLAY display for tracks which contain single track recording data. When the REC/ WRITE key is pressed, “REC” will be displayed for the selected tracks.

- Start and stop operations must be executed on the master unit.
- If the slave side MIDI device is able to use Song Select or Song Position Pointer messages, selecting a song or measure on the 01/WFD•01/W being used as a master device will make the External Clock device start from the same location of the same song. This is the same if the 01/WFD•01/W is being used as a slave device as well.
- If a MIDI clock is supplied from an external device when the 01/WFD•01/W is being used as a slave unit, start and stop operations can be carried out from either the MIDI device or the 01/WFD•01/W, but this will be subject to the MIDI clock which is inputting the tempo.

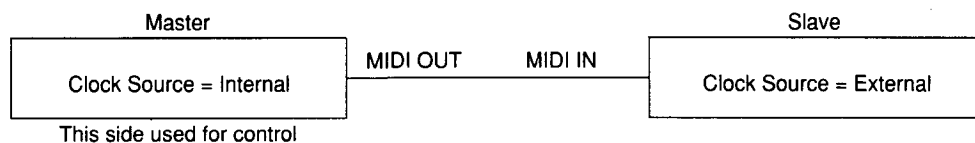

Page-1 Track 1—8 Parameters

P1-1 Track Status
 P1-2 Track Protect
 P1-3 Transpose
 P1-4 Detune

SONG0 P1:TRK PARA 1-8 ▶Track Status							
Tr01	Tr02	Tr03	Tr04	Tr05	Tr06	Tr07	Tr08
BOTH	BOTH	BOTH	BOTH	BOTH	BOTH	BOTH	BOTH
ON	ON	ON	OFF	OFF	OFF	OFF	OFF
T+00	T-12	T+00	T+00	T+00	T+00	T+00	T+00
D+00	D+00	D+00	D+00	D+00	D+00	D+00	D+00
A	B	C	D	E	F	G	H

P1-1 Status

[A]	Track 1	OFF INT EXT BOTH	Not played back Played back only internally Played back only from MIDI OUT Played back both internally and from MIDI OUT
:	:	:	
[H]	Track 8		

▼ You can specify whether each track will not be played back (OFF), played back only by the internal tone generators “INT”, played back only from MIDI OUT “EXT”, or played back by both (BOTH).

• If you have selected a track which is set to “EXT”, playing the keyboard will not make the internal tone generator produce sound. If the selected track is set to “INT” or “OFF”, playing the keyboard will not transmit data from MIDI OUT.

P1-2 Track Protect

[A]	Track 1	OFF/ON	Protect On/Off for each Track
:	:	:	
[H]	Track 8		

▼ If protect is turned On, changes cannot be made on that track, nor can the data be recorded or edited.

* When this is set to ON, changes made in the Volume or other settings are not written to the Sequence memory, so pressing the RESET key will return the data to the original settings. When this is set to OFF, Volume and other setting changes will be rewritten in the data. Select ON if you want no changes to be made your data.

P1-3 Transpose

[A]	Track 1	-24 — +24	Detune setting for each Track (one-cent steps)
:	:	:	
[H]	Track 8		

▼ Each Track can be transposed in chromatic steps.

• This has no effect on the data transmitted from MIDI OUT.

P1-4 Detune

A	Track 1	-50 — +50	Transpose setting for each Track (chromatic steps)
:	:	:	
H	Track 8		

▼ This adjusts the pitch of each track in one-cent steps.

Page-2 Track 9 — 16 Parameter

SONG0 P2:TRK PARA 9-16▶Track Status							
Tr09	Tr10	Tr11	Tr12	Tr13	Tr14	Tr15	Tr16
BOTH	BOTH	INT	INT	EXT	EXT	OFF	OFF
OFF	OFF	OFF	OFF	OFF	OFF	OFF	OFF
T+00	T+00	T+00	T+00	T+00	T+00	T+00	T+00
D+00	D+00	D+00	D+00	D+00	D+00	D+00	D+00
A	B	C	D	E	F	G	H

▼ Status, Protect, Transpose, and Detune settings for tracks 9 — 16.

- The details are the same as for Page-1 Track 1 — 8 Parameter.

Page-3 Track 1 — 8 Channel/Window

P3-1 MIDI Channel
 P3-2 Velocity Window Top
 P3-3 Velocity Window Bottom
 P3-4 Key Window Top
 P3-5 Key Window Bottom

SONG0 P3:CH/WINDOW1-8 ▶MIDI Ch							
Tr01	Tr02	Tr03	Tr04	Tr05	Tr06	Tr07	Tr08
01G	02	03	04	05	06	07	08
127	127	127	127	127	127	127	127
001	001	001	001	001	001	001	001
G9	C7	B0	B2	B4	B6	G9	G9
C-1	C2	C-1	C1	C3	C5	C7	C4
A	B	C	D	E	F	G	H

P3-1 MIDI Channel

[A]	Track 1	1 — 16	MIDI transmit channel for each track
:	:	:	
[H]	Track 8		

▼ This determines the MIDI transmit channel (1 — 16) for each Track.

- If the channel is the same as the Global channel, a “G” will be displayed after the channel number.

• When the 01/WFD•01/W keyboard is played, the track selected in P0-1 sounds, but other tracks assigned to the same MIDI channel will also sound. In addition, when P0-1 is “MULT”, the tracks assigned to the same MIDI channel as the Global channel (a “G” is displayed) will sound.

• By assigning the same MIDI channel to Tracks for which different Programs are selected, you can play those Programs in unison.

Example:

Track 1	Data	ch: 3	Prog A10
Track 2	No data	ch: 3	Prog B30

As a result, Programs A10 and B30 will be played in unison.

• It is also possible to set two or more tracks to the same MIDI channel, and divide the musical data between the tracks; for example, placing note data in one track and control data in another track.

Example:

Track 1	Note data	ch: 1	Prog A15
Track 2	Control data	ch: 1	Prog OFF

Prog A10 and B30 Layer

Track 1 data is used to combine programs A10 and B30 for playback.

• The MIDI channel selected here will be used for MIDI data output from tracks which have been assigned status of “EXT” or “BOTH”.

P3-2 Velocity Window Top

[A]	Track 1	1 — 127	Upper limit of the velocity window
:	:	:	
[H]	Track 8		

▼ This determines the upper limit of the velocity that will play the Program assigned to each Track 1 — 8.

P3-3 Velocity Window Bottom

[A]	Track 1	1 — 127	Lower limit of the velocity window
:	:	:	
[H]	Track 8		

▼ This determines the lower limit of the velocity that will play the Program assigned to each Track 1 — 8.

P3-4 Key Window Top

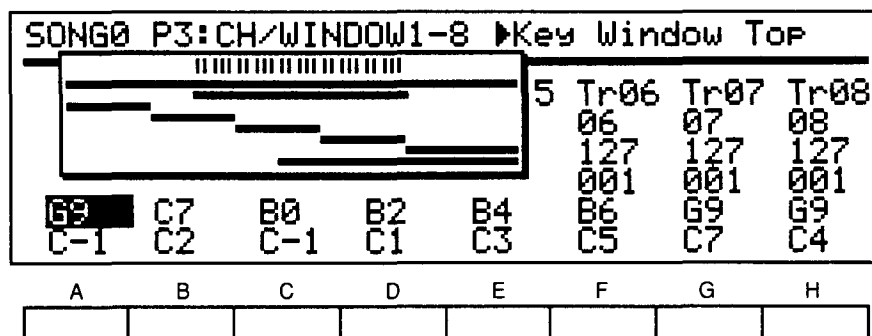

[A]	Track 1	C-1 — G9	Upper limit of the key window
:	:	:	
[H]	Track 8		

▼ This determines the highest note of the key range that will play the Program assigned to each Track 1 — 8.

P3-5 Key Window Bottom

[A]	Track 1	C-1 — G9	Lower limit of the key window
:	:	:	
[H]	Track 8		

▼ This determines the lowest note of the key range that will play the Program assigned to each Track 1 — 8.

- When recording, only the notes that fall inside the specified velocity window and key window will be recorded.
- By setting two or more Tracks to the same MIDI channel but different velocity and key windows, you can record and playback using velocity switched and/or key split sounds.

- When editing the key window, the display will show a graphic indication of the key window setting for each Track.
- To exit the display, move the cursor to a parameter other than key window.
- Key window settings can also be made using the keyboard. While pressing a key [A] — [H], press a key. When you release the key [A] — [H], the data will be entered.

Page-4 Track 9 — 16 Channel/Window

SONG0 P4:CH/WINDOW9-16▶MIDI Ch							
Tr09	Tr10	Tr11	Tr12	Tr13	Tr14	Tr15	Tr16
09	10	11	12	13	14	15	16
127	127	127	127	127	127	127	127
001	001	001	001	001	001	001	001
G9	G9	G9	G9	G9	G9	G9	G9
C-1	C-1	C-1	C-1	C-1	C-1	C-1	C-1
A	B	C	D	E	F	G	H

▼MIDI channel, velocity window, and key window settings for each track 9 — 16. Details are the same as for Page-3 Track 1 — 8 Channel/Window.

Page-5 Edit Song

P5-1 Step Recording

SONG0 P5:EDIT SONG		▶Track Number
▶Step Recording	Create CTRL Data	Bounce Track
Event Edit	Erase Track	Copy Track
		Erase Song
		Append Song
Track01	Meas001	(REC + S/S to Start)
A	B	C
D	E	F
G	H	

[A]	Track	1 — 16	The Track number to record
[C]	Measure	1 — 999	The measure at which to begin recording

- Press the REC/WRITE key, and then press the START/STOP key to enter the step recording display.

SONG0 P5:Step REC		▶Beat
Track = 1	Measure = 001	
Location = 1:00	98% Free	-M001--Beat: 4/4 --
4/4	♪-	U064 075% [RST] [◀]
A	B	C
D	E	F
G	H	

[A]	Beat	01/04 — 9/04 01/08 — 16/08 01/16 — 16/16 01/04 — 05/04 01/08 — 10/08 01/16 — 16/16	Display and set the time signature Low base resolution High base resolution
[B]	Step Time	♪,♪,♪,♪,♪,♪,○	Basic note length
[C]	Triplet/Dot	3 — •	Triplet of note length specified by Step Note length specified by Step Dotted note of note length specified by Step
[D]	Key Dynamics	002 — 126, key	Note velocity (002 — 126), key input
[E]	Note length	1 — 100 [%]	Note duration
[F]		[RST]	Specify a rest
[G]		[TIE]	Specify a tie (only when a note has been input)
[H]		[◀]	Go back one step

Step recording

■ Step recording allows you to enter notes one by one from the keyboard, specifying the length and velocity for each note. If you step record over a measure which already contains data, the old data in that measure will be lost.

- (1) Specify the track program, volume, pan, etc. for the song you will be recording (P0).
- (2) Specify the track ([A]) and starting measure ([C]) for recording.
- (3) Press REC/WRITE to make the indicator light, and then press START/STOP.
 - The upper left of the display will indicate the track measure number which is being recorded, the current beat of that measure, and the current "clock" in that beat. (0:01 corresponds to a 1/96th of a quarter note.)
- (4) Specify the beat ([A]).
 - If you have already finished recording other Tracks, the beat of the other Tracks will be displayed.
 - If you change the beat, the beat of other Tracks will also be changed.
- (5) Specify the type of note to be input, using step time ([B]) and triplet / dot ([C]). A triplet "3" changes the step time by 2/3, and a dot "." changes the step time by 3/2.

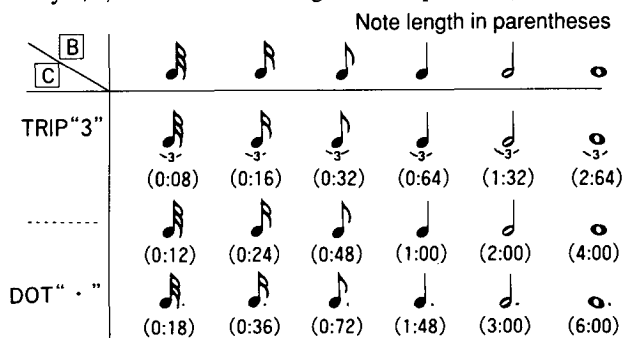

- (6) Use note length ([E]) to adjust the length of the note specified by the step time ([B]) and triplet/dot ([C]).

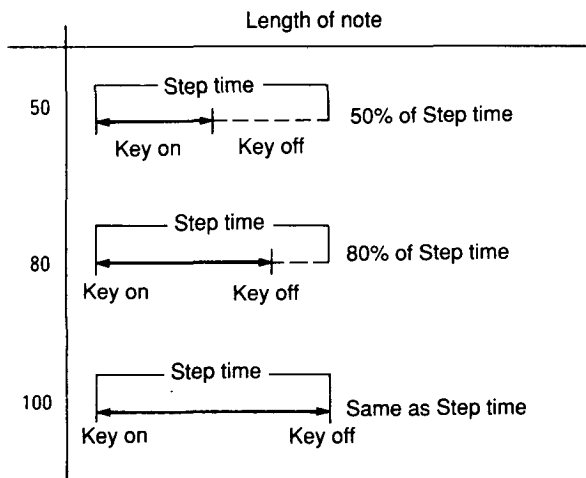

- (7) Use key dynamics ([D]) to specify the loudness of the note.
 - In step recording if Key Dynamics is set to "Key", the velocity of each note will be recorded just as you actually played it. However if Key Dynamics is set to "002—126", the actual played velocity of the note will be ignored and the velocity specified by the numeric values will be recorded.
- (8) Use the keyboard to enter a note. (To enter a chord, press that chord.) Regardless of the timing with which they were pressed, each note that is pressed until all notes are released will be recorded at the same step.
 - Pressing each note on the keyboard will display the key on position, pitch name, velocity and note length on the right hand side of the display.
- (9) When all notes are released, you will advance to the next step. Repeat steps (5) — (8) as many times as necessary.
 - To enter a rest, specify the length of the rest and then press [RST] ([F]).
- (10) When you are finished recording, press "START/STOP" to exit step recording.

- When you press [RST] ([F]), the position will advance by the specified step time.
- When you press [TIE] ([G]), the note you entered in the previous step will be lengthened as specified in step (5).

☆ In order to enter a note that is longer than the setting specified in step (5). You can either change the step time or use a tie to lengthen the note. These two methods will result in different note durations, as follows.

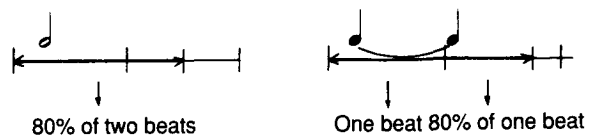

☆ You can also enter a tie while you are pressing a key, and that note will be lengthened by the value of the step time. In this case, the time will apply only to the note you are holding, so you can give different note lengths to individual notes in a chord.

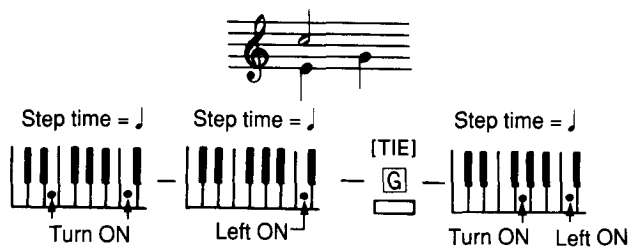

- Pressing [\blacktriangleleft] (\boxed{H}) will move back one step as specified by in step (5). If any notes exist at or later than that position, they will be deleted.
- This function is useful when you make a mistake, and also allows you to shorten the step time and enter notes as follows.

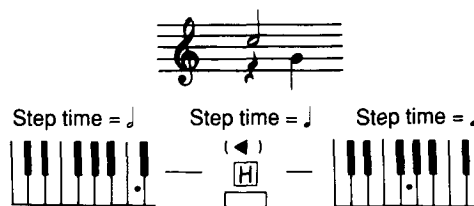

☆ In step recording only notes can be entered, not control data. If necessary, you can record control data into another Track in realtime and then use the Bounce function (mix the two tracks), or insert control data using Event Edit or Create CNTL.

P5-2 Create Control Data

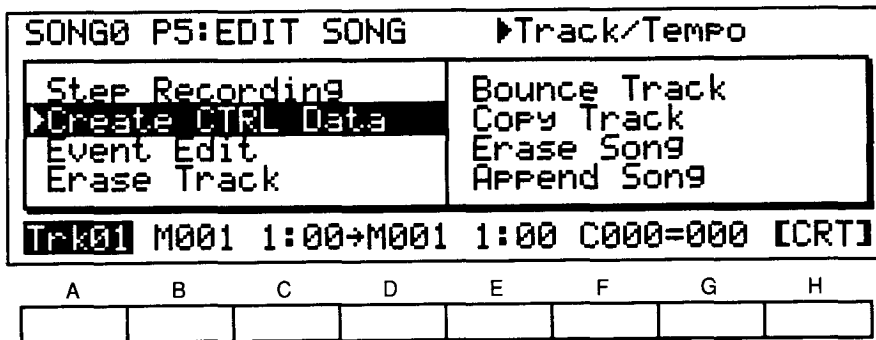

[A]	Track	Trk01 — Trk16, Tempo	The track you wish to modify
[B] M	Start Measure	001 — 999	The measure from which to begin modifying, and the location in that measure
[C]	Start Location	1:00 — 9:95	
[D] M	End Measure	001 — 999	The measure at which to stop modifying, and the location in that measure
[E]	End Location	1:00 — 9:95	
[F]	Controller	BEND, AFTT, C000 — C102	The controller to be modified
[G]	End Value	ERA, -8192 — +8191 ERA, 40 — 240 ERA, 0 — 127, C, C+D, D, ALL, PRG ERA, 0 — 127	The final value of the modified data (for bend) (for tempo) When Control No. = 10 (Pan) (for other)
[H]		CRT	Create Control Data function is carried out

This operation inserts data which gradually modify control data over the specified range.

- (1) Select the track ([A]) in which you wish to modify data.
- (2) Select the controller ([F]) you wish to modify. See the table on page 126.
- (3) Specify the measure ([B]) from which to begin modifying the data, and the location ([C]) in that measure.
- (4) Specify the measure ([D]) at which to stop the data, and the location ([E]) in that measure.
- (5) Specify the final value ([G]) (the resulting value) of the modified data.
- (6) Press [CRT] ([H]) to execute the Create operation.

- If you select “Tempo” as the Track, the controller display will be “♩= ”.
- If you specify “ERA” as the End Value, the specified controller data will be erased from the specified area of the specified track.
- When you move the cursor to the end value ([G]), the start value (the value of the start measure/location) and the end value will be displayed in the upper right of the display.
- The location will be displayed as quarter note beats in the measure and the number of clocks in that beat.

- The conditions of the tracks in the measure selected and the 16 measures which follow are shown in a graphic display.

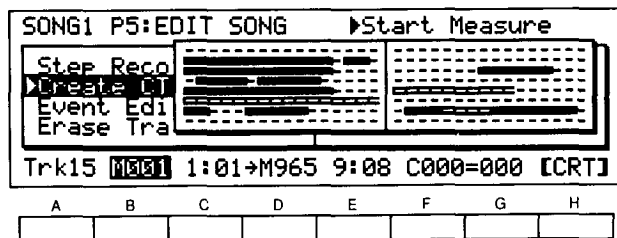

The left half of the display shows tracks 1-8, and the right half shows tracks 9-16. The track farthest to the left is the measure which has currently been selected. Measures which contain data will be written over. The measure where the pattern is placed is indicated by .

- Each clock corresponds to 1/96th of a quarter note. (One MIDI clock is equivalent to four clocks of the 01/WFD•01/W.)
- When P9-7 Base Resolution has been set to “High”, the location clock can be specified in individual steps. When it has been set to “Low”, the location clock can be specified in steps of 2.

- It is not possible to set the end location before the start location.

e.x. The following example shows an arbitrary selected measure on a Track, where, **[C]** = 3:48, **[E]** = 4:24, **[F]** = AFTT (Aftertouch), and **[G]** =100.

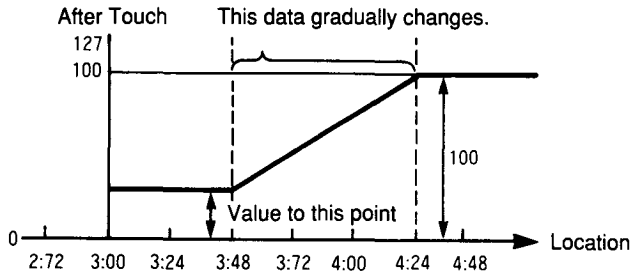

- * If any Pattern which has been put exists between the Start and End, the display will ask you if you wish to open the Pattern when you try to execute the Create operation. Selecting "Yes" will open the Pattern on the Track.

If you select "No" or there is not enough memory space left for Pattern opening, the control data will not be recorded into the measure.

- * Because a large amount of memory is used when making major value changes for a number of measures, a suitable amount of quantization will make this operation more manageable.

- * There are 11 Pan settings (from A to B) available in the O1/W. Values 0-127 are enabled when controlling Pans for external devices via MIDI OUT, but this puts a large demand on the memory of the O1/WFD•O1/W. Because of this, these settings should be made during Real Time Recording or Event Edit operations.

P5-3 Event Edit

SONG0 P5:EDIT SONG ▶Track Number

Step Recording	Bounce Track
Create CTRL Data	Copy Track
▶Event Edit	Erase Song
Erase Track	Append Song

Track01 (REC + S/S to Start)

A	B	C	D	E	F	G	H

[B]	Track	1 — 16, Tempo	The track to be edited
------------	-------	---------------	------------------------

- * If you press the REC/WRITE key the following display will appear (the Event Filter display).

SONG0 P5:EDIT SONG Note Data

▶Event Edit	Event Filter
	NOTE CTRL AFTT BEND PROG PAFT
	[B] ENA ENA ENA ENA ENA ENA

A	B	C	D	E	F	G	H

[B] NOTE	Note	DIS/ENA	Type of Event to display and edit (Events with a setting of DIS will not be displayed during edit).
[C] CTRL	Control Change	DIS/ENA	
[D] AFTT	After Touch	DIS/ENA	
[E] BEND	Bend	DIS/ENA	
[F] PROG	Program Change	DIS/ENA	
[G] PAFT	Poly After Touch	DIS/ENA	

6. SEQUENCER MODE

* If you now press the START/STOP key, the following display will appear (the Edit display).

SONG0 P5: Track01				▶Measure			
M001	#000	===	BAR	Beat:	4/4		
M001	#001	1:00	C#2	U064	0:72		
M002	#000	===	BAR	Beat:	4/4		
M002	#001	1:00	F#3	U074	0:00		
M002	#002	1:00	G3	U098	0:52		
M002	#003	1:00	A3	U114	0:53		

A	B	C	D	E	F	G	H

[A] M	Measure	001 — 999	The measure to be edited
[B] #	Index	000 —	Event index *1
[C]	Location	TIE, 1:00 — 9:95	Event timing within the measure
[D]	Event	BAR C-1 — G9 BEND AFTT PROG CTRL PAFT TEMPO	Type of event Bar line Note Pitch bend Channel aftertouch Program change Control change Poly aftertouch Tempo change (only tempo track)
[E]	Beat	1/4 — 9/4 1/8 — 16/8 1/16 — 16/16 1/4 — 05/4 1/8 — 10/8 1/16 — 16/16	(For bar lines) } Low base resolution } High base resolution
V	Velocity	2 — 126	(For notes)
	Bend	-8192 — 8191	(For pitch bend)
	After Touch	0 — 127	(For channel aftertouch)
	Program Bank	A, B, 2 — 127, GM, GMD, ---	(For program changes)
C	Controller No.	0 — 102	(For control changes)
	Poly After Touch Key	C- 1 — G9	(For poly aftertouch)
J	Tempo	40 — 240	(For tempo changes) (only tempo track)
[F]	Length	0:00 — 9:00, TIE	Note length (for notes)
	Program Number	00 — 127	(for program changes)
	Data Value	0 — 127, C, C+D, D, ALL, PRG	(Control No. = 10 (Pan))
	Data	0 — 127	Control data (for control changes)
[G] [INS]			Insert an event
[H] [DEL]			Delete an event

* Two or more events in a single measure are numbered consecutively from the beginning of the measure. When you modify the location, its index will be renumbered automatically.

About Event Edit

A single step of musical data is called an “event”. Event Edit allows you to modify, insert, or delete individual events from the data in a Track.

A note event consists of the note pitch (note number), loudness (velocity), and note length. For data other than notes, one MIDI type message is considered an event.

☆ Since event edit allows you to directly modify sequence data, careless editing can modify the data so that it can no longer be restored to its original state. Please use caution.

- (1) Specify the Track ([B]) to edit.
- (2) Press REC/WRITE to make the indicator light. The Event Filter setting will be displayed, so set the event types which you want to edit to “ENA”. (Events set to “DIS” will not be displayed during editing.)

NOTE	Note data
CNTL	Control change
AFTT	Channel aftertouch
BEND	Pitch bend
PROG	Program change
PAFT	Poly aftertouch

- (3) Press START/STOP and the event editing display will appear.

* If you move to Event Edit after stopping a song during playback, you can select the beginning of the measure where playback was ended.

- (4) Use the cursor UP/DOWN keys or modify the value of the measure ([A]) and index ([B]) to select the event you wish to edit.
- (5) Select a parameter, and edit it.
- (6) When you have finished, press START/STOP to exit event editing.
 - The location is indicated by the beat number in the measure and the clock number in that beat.
 - One clock is 1/96th of a quarter note. (A MIDI clock corresponds to 4 clocks of the 01/WFD*01/W.)
 - If the P9-7 Base Resolution has been set to “High”, you will be able to modify the location clock in units of 1, but if this has been set to “Low”, in units of 2. (When “Low” is selected, a quarter note is divided into 48 divisions.)

◆ For note events, [D] indicates the note name (pitch), [E] indicates the velocity (loudness), and [F] indicates the length (note duration).

- The velocity cannot be set to an odd numbered value.
- In event edit mode, notes will be sounded. (When you edit a note, it will be sounded with the current data.)

SONG9 P5: Track01					▶Index		
M001	#041	4:00	C3	U064	0:72		
M001	#042	4:00	D3	U064	0:72		
M002	#000	==	BAR	Beat:	4/4		
M002	#001	1:00	G3	U064	0:72		
M002	#002	1:00	C3	U064	0:72		
M002	#003	2:00	B2	U064	0:72	[INS]	[DEL]
A	B	C	D	E	F	G	H

◆ For pitch bend and aftertouch, [E] indicates the data value.

SONG9 P5: Track01					▶Measure		
M006	#049	1:00	BEND	-3281			
M006	#050	1:00	BEND	-1367			
M006	#051	1:00	BEND	+0000			
M006	#052	1:00	BEND	+0696			
M006	#053	1:00	BEND	+2816			
M006	#054	1:00	BEND	+4663			[INS] [DEL]
A	B	C	D	E	F	G	H

* The “GM” and “GMD (GMD rum)” parameters in the bank are provided to control an external GM or other sound source. The voice and drum set used for GM are selected with the sound source corresponding to the GM sound source to which the data is sent.

MIDI message - GM: Bn, 00, 38, 20, 00
GMD: Bn, 00, 3E, 20, 00

Also, if “--” is entered, the bank change will no longer be output in MIDI format.

◆ For control change events, [E] indicates the control number and [F] indicates the data value.

SONG9 P5: Track01					▶Measure		
M004	#029	1:87	CTRL	C002	043		
M004	#030	1:90	CTRL	C002	000		
M004	#031	1:95	CTRL	C001	029		
M004	#032	2:02	CTRL	C001	052		
M004	#033	2:05	CTRL	C001	073		
M004	#034	2:08	CTRL	C001	088		[INS] [DEL]
A	B	C	D	E	F	G	H

◆ For program changes, [E] indicates the bank, and [F] indicates the program number.

6. SEQUENCER MODE

Control No.	Type of control	Value	Note
1	Pitch modulation	0 (off) — 127 (max)	Turn the joystick in the direction of + Y (forward) Turn the joystick in the direction of - Y (forward you).
2	VDF modulation	0 (off) — 127 (max)	
7	Volume	0 (min) — 127 (max)	0 — 127 refers to Pan settings from A to B
10	Panpot	0 (A) — 127 (B), C, C+D, D, ALL, PRG	
12	Effect 1 control	0 (min) — 127 (max)	• Effect 1 dynamic modulation • Effect 2 dynamic modulation
13	Effect 2 control	0 (min) — 127 (max)	
64	Damper switch	0 (off), 127 (on)	• Effect 1 on/off • Effect 2 on/off
91	Effect 1 switch	0 — 63 (OFF), 64 — 127 (ON)	
92	Effect 2 switch	0 — 63 (off), 64 — 127 (ON)	• A value of 64 will set VDF Cutoff to the edited value of the Program
102	VDF cutoff	0 (low) — 64 — 127 (high)	

- Control numbers not listed in this table indicate control change data that is recorded only from MIDI IN.
- Control number 102 is not received or transmitted via MIDI.

◆ For poly aftertouch events, [E] indicates the pitch name, and [F] indicates the value of the aftertouch.

- The 01/WFD•01/W is not affected by the poly aftertouch function, which controls the poly aftertouch of the external MIDI instruments.

◆ For bar line events, [F] indicates the time signature.

- When the time signature is edited, the time signature of other Tracks will automatically be changed.

SONG9 P5: Track01				▶Beat
M019	#004	1:09	CTRL C001 000	
M020	#000	==	BAR Beat: 15/16	
M020	#001	1:18	CTRL C001 001	
M020	#002	1:21	CTRL C001 015	
M021	#000	==	BAR Beat: 15/16	
M021	#001	1:01	CTRL C001 031	[INS]

A	B	C	D	E	F	G	H

Editing an event

- [D] modifies the note pitch or event type, and [E] and [F] modify the event data. (Refer to the table of event types.)

Moving an event

- Use [C] to move the event within that measure.
- If an event has been moved so as to change the order of events, the index numbers within the measure will be re-numbered.

- ◆ Measures which contain a Pattern will be displayed as follows. (These cannot be edited. To replace a pattern, use P6-8 Put/Copy Pattern.)

- * If the piece contains a pattern which consists of two or more measures, (H) is displayed in the first measure of that pattern.

SONG9 P5: Track03				▶Measure
M002	#000	==	BAR	Beat: 4/4
M003	==	Pat00(H)	==	Beat: 4/4
M004	==	Pat00(H)	==	Beat: 4/4
M005	==	Pat00(H)	==	Beat: 1/16
M006	==	Pat00(H)	==	Beat: 1/16
M007	==	Pat00(H)	==	Beat: 1/16

A	B	C	D	E	F	G	H

- Events can be moved to another measure by using the delete and insert functions.

* Use the Tempo Track to edit the Tempo.

* Track data set in the Global channel determines the switches and controls used for Effects 1 and 2.

* Values 0 — 127 correspond to the Pan settings from A to B as shown in the table below.

Event edit value	Pan setting on the 01/W	Event edit value	Pan setting on the 01/W
0 — 11	A	70 — 81	4 : 6
12 — 23	9 : 1	82 — 93	3 : 7
24 — 34	8 : 2	94 — 104	2 : 8
35 — 46	7 : 3	105 — 116	1 : 9
47 — 58	6 : 4	117 — 127	B
59 — 69	5 : 5		

Deleting an event

- Press [DEL] ([H]) to delete the event at the cursor.
- If you accidentally delete a note, press insert ([G]) before doing anything else, and the note will be restored. However if the note was tied, inserting it will not restore it to its original length.

Inserting an event

- Press [INS] ([G]) to create a new event at the location of the cursor. By modifying the location or editing the event, you can use this to insert any desired event.
- If you insert immediately after deleting, the deleted event will be inserted.

☆ It is also possible to insert events into a new Track. In this case, you must first use P6-7 Insert Measure to create blank measures.

☆ Notes which overlap bar lines are treated as two tied notes.

To edit such notes, use the following procedure. (Refer to the diagram on the right.)

- (1) Edit the note number and velocity for note A. Note B will automatically be corrected.
- (2) To change the note length, edit note B.
- (3) To delete notes A+B, delete in the order of A, then B. If you delete only B, the length of A will extend to the end of the measure it is located in. (If you set the length of A to other than [TIE], note B will be given a location of 1:00.)

- (4) To insert A+B, insert B at location 1:00, then insert A, and then set the note length to [TIE]. Set the note numbers and velocities of A and B to the same values.

SONG9 P5: Track04		Measure	
M003	#000	===	BAR Beat: 4/4
M003	#001	TIE	C4 TIE
M003	#002	4:43	A3 U090 TIE
M003	#003	4:49	E3 U098 TIE
M004	#000	===	BAR Beat: 4/4
M004	#001	TIE	C4 3:30 [DEL]

A	B	C	D	E	F	G	H

- ☆ If you make a mistake, press the COMPARE key before performing any other edit operation, and the data before editing will be restored.

P5-4 Erase Track

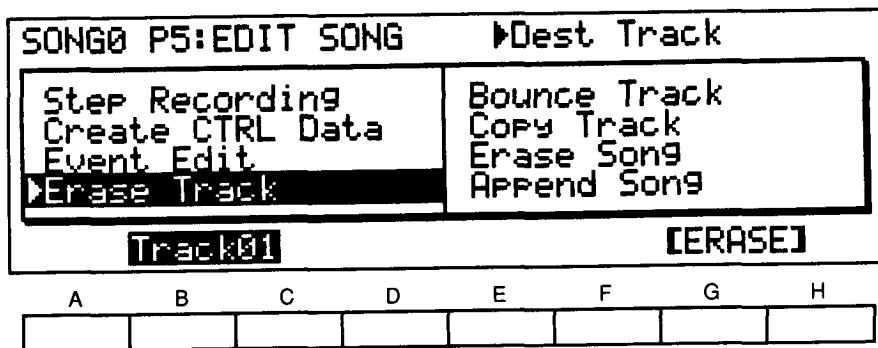

[B]	Track	1 — 16	Specify the Track to be erased
[G]		[ERASE]	Execute the Erase operation

■ This function erases a Track from a Song.

- (1) Select the Track ([B]) to be erased.
- (2) Press [ERASE] ([G]) and the track will be erased.

☆ If you erase a track by mistake, you can press the COMPARE key to restore the previous data before performing any other editing operation.

P5-5 Bounce Track

SONG0 P5:EDIT SONG		▶Source Track	
Step Recording	▶Bounce Track	Copy Track	
Create CTRL Data	Erase Song	Append Song	
Event Edit			
Erase Track			
Track01 → Track02		[BOUNCE]	
A	B	C	D
E	F	G	H

[B]	Source Track	1 — 16	Specify the track to be copied
[D]	Dest Track	1 — 16	Specify the bounce destination track
[G]		[BOUNCE]	Execute the Bounce operation

This operation combines the data of two tracks into 1 track.

- (1) Select the source Track ([B] : the Track to combine) and the destination Track ([D] : the Track into which to combine the data).
- (2) Press [BOUNCE] ([G]) and the data will be combined.
 - When the Bounce operation is completed, the data in the source track will be erased.
 - The settings of the destination Track will determine the value of track parameters such as Track program and MIDI channel. (If you bounce tracks with different program or MIDI channel settings, the program and MIDI channel settings will no longer be distinguished, and you will no longer be able to separate the data.)

- If both Tracks contain control change data etc., this bounce function can have unexpected effects. (You can use P6-5 Erase Measure to delete control change data.)

- ☆ If you bounce by mistake, press the COMPARE key to restore the previous data before editing again.
- * When bouncing a track in which a Pattern has been Put, the display will ask you if you wish to open the Patterns. Selecting "Yes" will open the Pattern on the track, and selecting "No" will cancel the Put Pattern.

P5-6 Copy Track

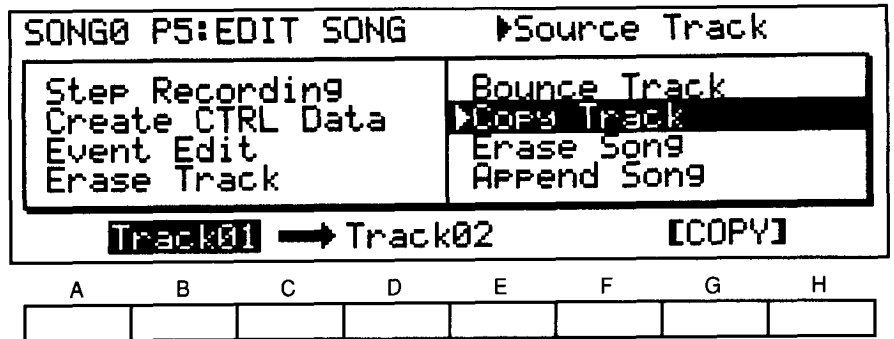

[B]	Source Track	1 — 16	The track to copy
[D]	Dest Track	1 — 16	The copy destination track
[G]		[COPY]	Execute the Copy operation

■ This operation copies a Track to another Track.

(1) Select the source Track ([B]: the Track to copy) and the destination Track ([D]: the Track into which the data will be copied).

(2) Press [COPY] ([G]) and the data will be copied.

* If you copy by mistake, press the COMPARE key to restore the previous data before editing again.

P5-7 Erase Song

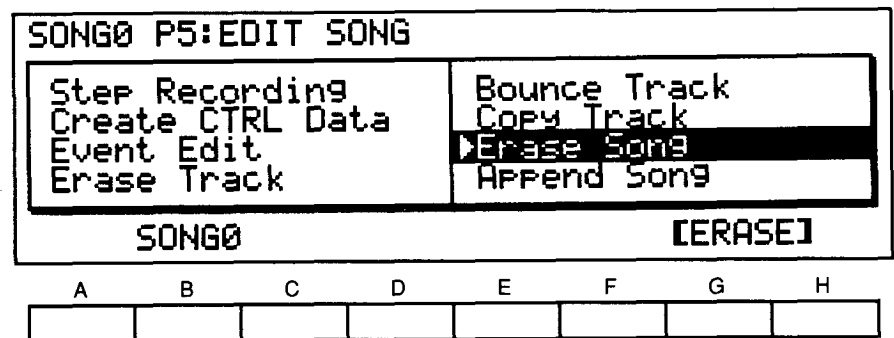

[G]		[ERASE]	Erase the track
-----	--	---------	-----------------

▼ This function erases all data from the Song.

- Press [ERASE] ([G]) to erase the song. The song erased will be the one currently selected by P0-1.

* If you erase by mistake, press the COMPARE key to restore the original data.

P5-8 Append Song

SONG0 P5:EDIT SONG		▶Source Song
Step Recording Create CTRL Data Event Edit Erase Track	Bounce Track Copy Track Erase Song ▶Append Song	
SONG0		[APPEND]
A	B	C
D	E	F
G	H	

[B]	Source Song	0 — 9	Specify the source Song
[G]		[APPEND]	Execute the Append operation

■ This function appends the data from a specified Song to the end of the currently selected Song.

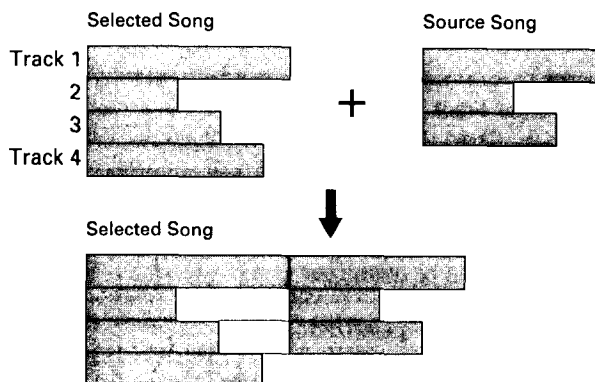

- Press ([B]) to select the song to append, and press [APPEND] ([G]) to execute the operation.
 - The data of the Source song will not be affected.
 - Track parameters of the currently selected song will be used.
 - If the currently selected song has unnecessary blank space at the end, use P6-4 Delete Measure to delete it.
- ☆ If you append by mistake, press the COMPARE key to restore the previous data before editing again.

* It is not possible to append songs which have a different Base Resolution.

Page-6 Edit Measure

- When you specify the measures (the measures to be affected) for a measure editing function (P6-1 — P6-8), the condition of each Track will be displayed for 16 measures beginning with the specified measure. Please refer to P5-2 Create Control Data.

P6-1 Quantize

SONG0 P6:EDIT MEAS		▶Track/Tempo	
▶Quantize		Erase Measure	
Shift Note		Copy Measure	
Modify Velocity		Insert Measure	
Delete Measure		Put/Copy Pattern	
Trk	M001→001	ALL	R:Hi
			[QTZ]
A	B	C	D
E	F	G	H

[A] Trk	Track	1 — 16, Tempo	Number of Track to be quantized All tracks of the selected Song
[B] M	Start Measure	1 — 999	First measure to be quantized
[C]	End Measure	1 — 999	Last measure to be quantized
[D]	Quantize Data	ALL NOTE CTRL AFTT BEND PROG	Type of data to be quantized All data Note On/Off (keyboard data) Control changes only (joystick Y, damper, etc.) Aftertouch only Pitch bend (joystick X) only Program changes only
[E] R	Resolution	Hi, ♩3, ♪, ♪3, ♪, ♪3, ♪, ♪	The quantization step
[F] O	Offset	-96 — +96	The amount of time skew
[G] I	Intensity	0 — 100	The percentage of accuracy (%)
[H]		[QTZ]	Execute quantization

■ This operation corrects the timing of the data in the specified range to the nearest specified timing unit.

- (1) Specify the Track ([A]), first measure ([B]), and last measure ([C]) to be quantized.
- (2) Specify the data to be quantized ([D]). (This is not displayed when the Tempo Track is specified.)

- Selecting "AFTT" will quantize both Channel pressure and Poly aftertouch data. The 01/W does not respond to Poly aftertouch events.

(3) Specify the quantizing resolution (**[E]**), the offset (**[F]**), and the intensity (**[G]**) of the quantization.

- For example if you specify a resolution of 1/4, data will be corrected to the nearest quarter note.

Original Data

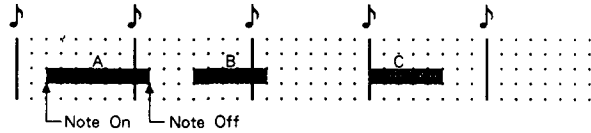

Ex1) Resolution = $\frac{1}{4}$, Offset = +00, Intensity = 100%

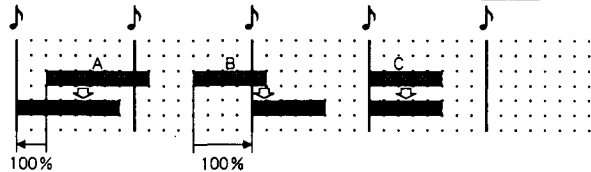

Ex2) Resolution = $\frac{1}{4}$, Offset = +00, Intensity = 50%

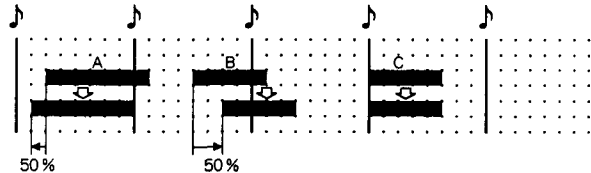

Ex3) Resolution = $\frac{1}{4}$, Offset = +24, Intensity = 100%

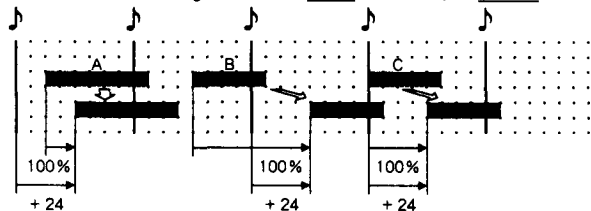

Ex4) Resolution = $\frac{1}{4}$, Offset = +24, Intensity = 75%

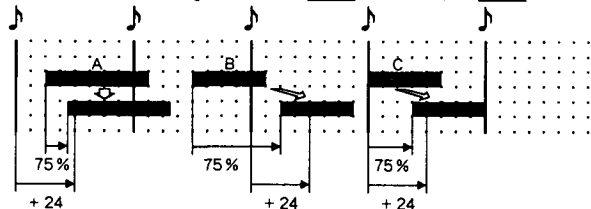

Ex5) Resolution = $\frac{1}{4}$, Offset = -12, Intensity = 100%

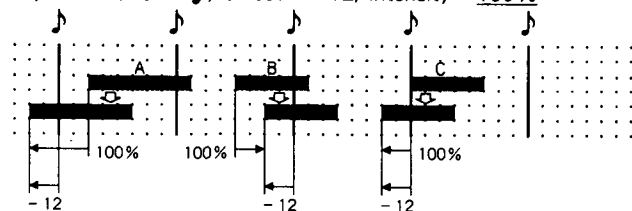

(4) Press [QTZ] (**[H]**) to execute quantization.

- Note on position will be corrected, but note length will remain the same.

☆ If quantization moves two control change events of the same type onto the same location, they will be combined into a single event. This allows you to use quantization to thin out control data and save memory.

- For a quantize resolution of "Hi", the resolution will be the same as the Base Resolution of the song.
- Quantizing at a resolution of "Hi" will thin out control data while leaving the timing of note data unchanged.
- You can quantize program change data to thin out unnecessary program changes that were recorded in realtime recording.
- When specifying the Start Measure or End Measure, the graph display will indicate the conditions of each Track.

☆ If you quantize by mistake, press the COMPARE key to restore the previous data before editing again.

Applications: You can offset the data located after the Start Measure by the amount specified in Offset by setting the End Measure to "999", Resolution to "Hi", and Intensity to "100". This allows you to erase unnecessary notes which have been recorded by mistake. However, please note that careless operation may cause the data to be damaged.

P6-2 Shift Note No.

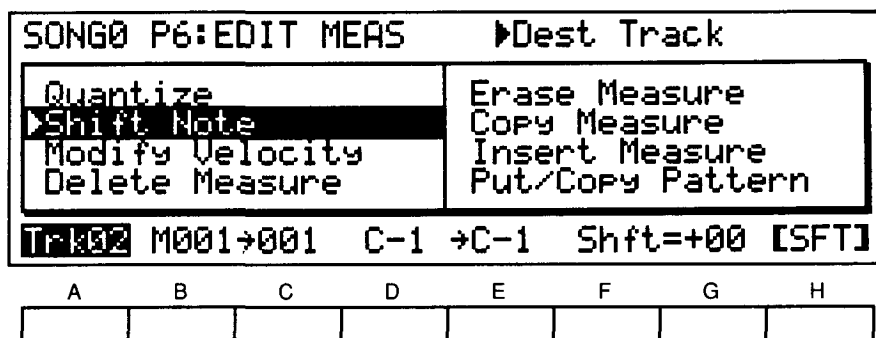

[A] Trk	Track	01 — 16	The track in which to shift notes
[B] M	Start Measure	001 — 999	The first measure for which to shift notes
[C]	End Measure	001 — 999	The last measure for which to shift notes
[D]	Note Range Bottom	C-1 — G9	The lowest note to be shifted
[E]	Note Range Top	C-1 — G9	The highest note to be shifted
[G]	Shift	-24 — +24	The number of chromatic steps by which to shift
[H]		[SFT]	Execute the Shift Note operation

■ This operation shifts (transposes) the note numbers in the specified area by the specified amount.

- (1) Specify the track ([A]), the first measure ([B]) and last measure ([C]), the lowest note ([D]) and the highest note ([E]).
- (2) Specify the number of chromatic steps by which the pitch will be shifted ([G]).
- (3) Press [SFT] ([H]) to execute the Shift Note operation.

- Shift specifies the transposition in chromatic steps, over a range of -2 — +2 octaves.

* If the specified range contains a Pattern which has been Put, the display will ask you if you wish to open the Pattern. Selecting "Yes" will open the Pattern, and a shift Note operation will be carried out on that data.

P6-3 Modify Velocity

SONG0 P6:EDIT MEAS		▶Dest Track					
Quantize	Erase Measure						
Shift Note	Copy Measure						
▶Modify Velocity	Insert Measure						
Delete Measure	Put/Copy Pattern						
Trk:Trk0101→001 V=001~127 I=000 Cv1 [MDF]							
A	B	C	D	E	F	G	H

[A] Trk	Track	01 — 16	The track in which to modify velocity
[B] M	Start Measure	001 — 999	The first measure for which to modify velocity
[C]	End Measure	001 — 999	The last measure for which to modify velocity
[D] V	Start Value	002 — 126	The initial velocity value
[E]	End Value	002 — 126	The last velocity value
[F] I	Intensity	000 — 100	The percentage (%) by which to modify the velocity
[G] Cv	Curve	1 — 6	The velocity curve
[H]		[MDF]	Execute the Modify Velocity operation

■ This operation changes the time setting and modifies the velocity values in the specified area by the specified intensity following the specified curve.

- (1) Specify the track ([A]), the first measure ([B]) and last measure ([C]), the velocity at the beginning of the range ([D]) and the velocity at the end of the range ([E]).
- (2) Specify how closely ([F]) the velocities will be modified toward the selected curve ([G]).
- (3) Press [MDF] to execute the Modify Velocity operation.

• When Intensity is 0, the velocity values will not change. When the Intensity is 100, the velocities will be changed to the specified curve.

* If the specified range contains a Pattern which has been Put, the display will ask you if you wish to open the Pattern. Selecting "Yes" will open the Pattern, and a Modify Velocity operation will be carried out on that data.

Modify Velocity Curve

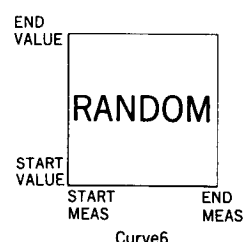
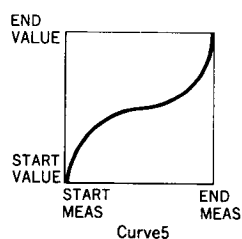
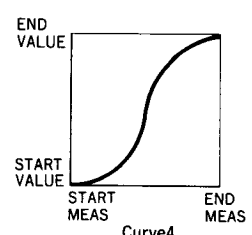
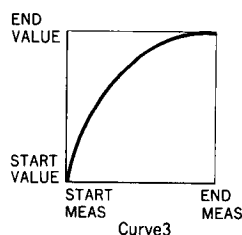
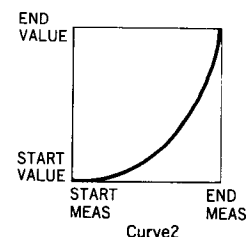
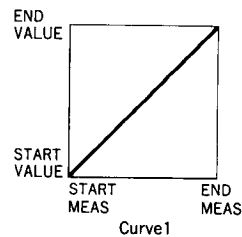

P6-4 Delete Measure

SONG0 P6:EDIT MEAS		▶Dest Track					
Quantize Shift Note Modify Velocity ▶Delete Measure	Erase Measure Copy Measure Insert Measure Put/Copy Pattern						
Trk:01 M001→001		[DELETE]					
A	B	C	D	E	F	G	H

[B] Trk	Dest Track	1 — 16, ALL	The Track to be edited
[C] M	Dest Start Measure	001 — 999	The first measure to be deleted
[D]	Dest End Measure	001 — 999	The last measure to be deleted
[G]		[DELETE]	Execute the Delete operation

- This operation deletes measures from the specified area.
- (1) Specify the track ([B]), first measure to be deleted ([C]), and the last measure to be deleted ([D]).
- (2) Press [DELETE] ([G]) to delete the measures.
- For example if you set [C] to 3 and [D] to 4, the two measures 3 and 4 will be deleted. (Refer to the diagram below.)

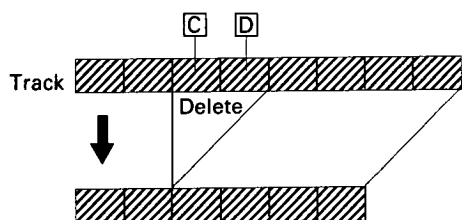

- If Track has been set to "ALL", the specified measures will be deleted from all Tracks.

- Measures after the deleted measures will be moved forward. The measures moved forward in this way will have the same time signature as measures in other tracks.

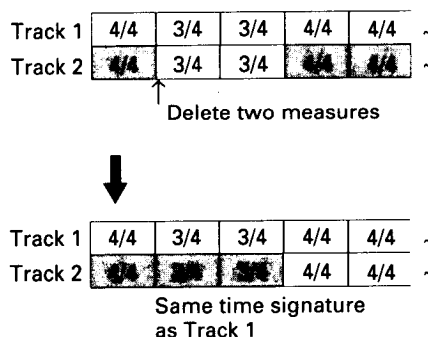

- If a note overlaps the entire area being erased, it will be shortened by the deleted length.
- * If you specify the End Measure within the Pattern which has been put, the display will ask you if you wish to open the Pattern when executing the operation.
 - Selecting "Yes" will open the Pattern.
 - Selecting "No" will cancel the Put Pattern.
- If you specify the Start Measure in the Pattern which has been Put, the measures starting from the Start Measure within the Pattern will not be played. This is the same as the operation to delete the corresponding measures.
- ☆ If you delete by mistake, press the COMPARE key to restore the previous data before editing again.

P6-5 Erase Measure

SONG0 P6:EDIT MEAS		▶Dest Track	
Quantize	▶Erase Measure	Copy Measure	
Shift Note		Insert Measure	
Modify Velocity		Put/Copy Pattern	
Delete Measure			
Trk01 M001→001 ALL		[ERASE]	
A	B	C	D
E	F	G	H

[B] Trk	Track	1 — 16, ALL	The Track to be erased
[C] M	Start Measure	001 — 999	The first measure to be erased
[D]	End Measure	001 — 999	The last measure to be erased
[E]	Erase Data	ALL NOTE CTRL AFTT BEND PROG	Type of data to be erased All data Note on/off data (keyboard data) only Control changes (joystick Y, damper, etc.) only Aftertouch only Pitch bend (joystick X) only Program changes only
[G]		[ERASE]	Execute the Erase operation

■ This function erases the specified data from the specified area.

(1) Specify the track ([B]), the first measure ([C]), and the last measure that will be erased ([D]).

(2) Specify the type of data to be erased.

• Selecting “AFTT” will erase both channel pressure and poly aftertouch data. The 01/WFD•01/W is not affected by the poly aftertouch function.

(3) Press [ERASE] ([G]) to erase the data.

• For example if you set [C] to 3 and [D] to 4, the two measures 3 and 4 will be erased.

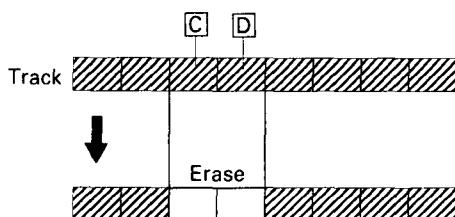

- If you specify “ALL” for Track, the specified measures will be erased from all tracks (including the tempo track).

- A Tempo Track can be erased by using event edit or create control data.

- If part of a note lies outside the specified range, only the portion within the range will be erased.

☆ If editing operations erase damper off or pitch bend (0 data) events, “stuck” damper pedal or pitch bend will result when the data is played back. In such cases you can either erase the corresponding damper on or pitch bend messages, or use the event edit function to correct the data.

* If you specify the End Measure within the Pattern which has been put, the display will ask you if you wish to open the Pattern when executing the operation.

Selecting “Yes” will open the Pattern.
Selecting “No” will cancel the Put Pattern.

If you specify the Start Measure in the Pattern which has been Put, the measures starting from the Start Measure within the Pattern will not be played. This is the same as the operation to erase the corresponding measures.

☆ If you erase by mistake, press the COMPARE key to restore the previous data before editing again.

P6-6 Copy Measure

SONG0 P6:EDIT MEAS				▶Source Track			
Quantize Shift Note Modify Velocity Delete Measure				Erase Measure ▶Copy Measure Insert Measure Put/Copy Pattern			
Trk01 M001→001				Trk01 M001 [COPY]			
A	B	C	D	E	F	G	H
□	□	□	□	□	□	□	□

[A] Trk	Source Track	1 — 16, ALL	The Track containing the measures to copy
[B] M	Source Start Measure	1 — 999	The first measure to copy
[C]	Source End Measure	1 — 999	The last measure to copy
[E] Trk	Dest Track	1 — 16, ALL	The track into which the measures will be copied
[F] M	Dest Start Measure	1 — 999	The first measure of the copy destination
[G]		[COPY]	Execute the Copy operation

This operation copies the specified range of data inside a song.

(1) Specify the copy source Track ([A]), the first measure ([B]), the last measure ([C]), the copy destination track number ([E]), and the first measure of the copy destination ([F]).

(2) Press [COPY] ([G]) to copy the data.

• For example if you set [B] to 5, [C] to 7, and [F] to 3, measures 5 — 7 of the source track will be copied to measures three through five of the destination track.

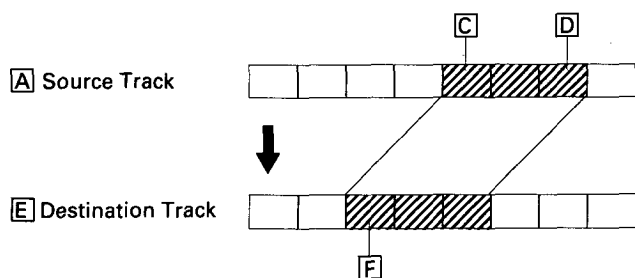

- The data in the copy destination measures will be lost.
- If you specify source measures which contain no data, blank measures will be copied.
- If data exists in tracks other than those from which you copied the measures, the time signature will be the same as that on the other tracks.
- If you have specified Tracks as "ALL", the same measures will be copied to all tracks (including the tempo track).
- * If the first measure to copy and the last measure of the copy destination are included in the Patterns which have been Put, the display will ask you if you wish to open the Patterns. Selecting "Yes" will open the Patterns, and selecting "No" will cancel the Put Pattern. If the last measure to copy is included in the Pattern which has been put, copied measures will be played. If the first measure of the copy destination is included in the Pattern which has been Put, the measures starting from the Dest Start Measure will not be played, but the copied measures will be played. This is the same as when the measures are copied normally.

☆ If you copy by mistake, press the COMPARE key to restore the previous data before editing again.

P6-7 Insert Measure

SONG0 P6:EDIT MEAS		▶Dest Track					
Quantize Shift Note Modify Velocity Delete Measure	Erase Measure Copy Measure ▶Insert Measure Put/Copy Pattern						
Trk:01 M001 L001 **/**		[INSERT]					
A	B	C	D	E	F	G	H

[B]	Trk	Dest Track	1 — 16, ALL	The Track into which the measure will be inserted
[C]	M	Dest Measure	001 — 999	The Measure position where the measure will be inserted
[D]	L	Insert Measure Length	001 — 999	The length of the measure to be inserted
[E]	Beat		**/** 01/04 — 09/04 01/08 — 16/08 01/16 — 16/16 01/04 — 05/04 01/08 — 10/08 01/16 — 16/16	Time signature of measures to be inserted Time signature will not change } Low base resolution } High base resolution
[G]			[INSERT]	Insert the measures

■ This operation inserts blank measures into the specified measure location.

- (1) Specify track ([B]), the measure to be inserted ([C]), the number of the measures to be inserted ([D]) and if necessary, the beat ([E]) of the measures to be inserted.
- (2) Press [INSERT] ([G]) to insert the measures.

• For example if you set [C] to 3 and [D] to 2, two measures will be inserted between measures 2 and 3.

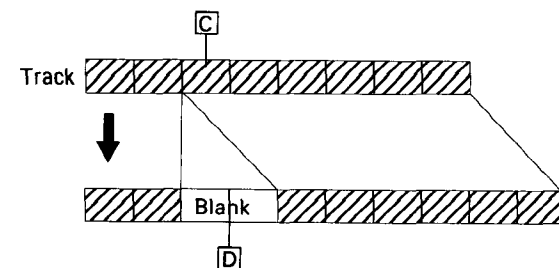

If BEAT: 07/08

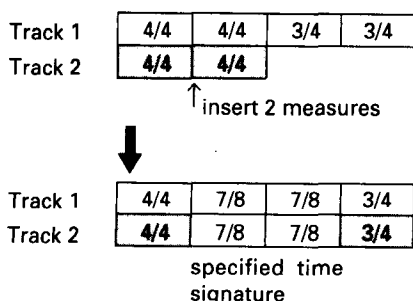

- If the Track has been set to "ALL", the measures will be inserted into all tracks (including the tempo track) which contain data.
- A note which extends beyond the specified first measure will be divided into two notes.
- When beat ([E]) is set to **/**, the time signature of the inserted measures will match the time signature of the measures already existing in the other tracks. If any other beat is specified, the other tracks will be changed to the specified beat.

e.g. If measures are inserted into Track 2:

If BEAT: **/**

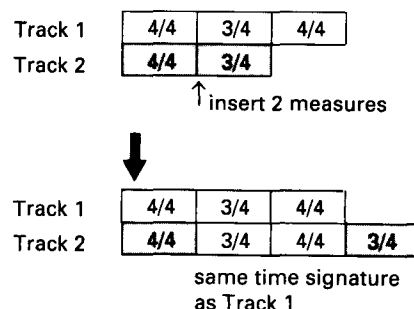

* If you try to insert measures within the Pattern which has been Put, the display will ask you if you wish to open the Pattern. Selecting "Yes" will open the Pattern, and selecting "No" will cancel the Put Pattern.

☆ If you insert by mistake, press the COMPARE key to restore the previous data before editing again.

P6-8 Put/Copy Pattern

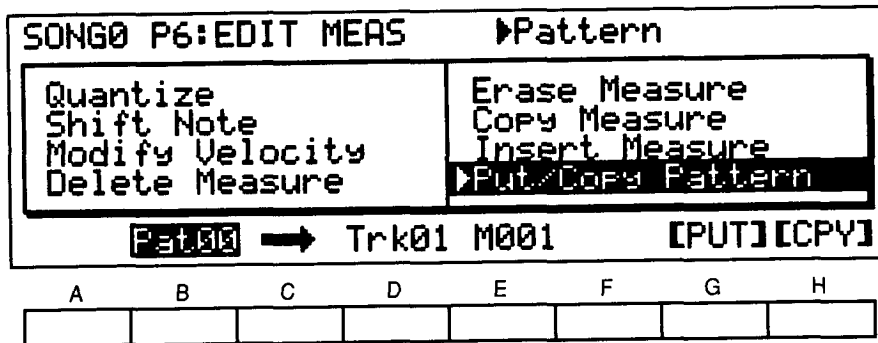

[B] Pat	Pattern	00 — 99	The Pattern to put/copy
[D] Trk	Dest Track	1 — 16	The Track into which the Pattern will be put/copied
[E] M	Dest Measure	1 — 999	The Measure into which the Pattern will be put/copied
[G]		[PUT]	Put the Pattern
[H]		[CPY]	Copy the Pattern

■ Put Pattern: This operation puts (assigns) a Pattern into a specified measure of a Track. The Track will contain only a pattern number, not the actual data.

• PUT PATTERN

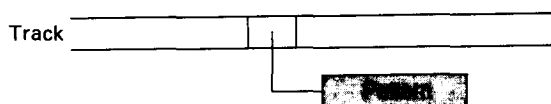

- Uses less memory
- When the Pattern is modified, playback will be affected

■ Copy Pattern: This operation copies musical data from the specified Pattern into the specified measure of a Track.

• COPY FROM PATTERN



- Track data can be edited
- Playback will not be affected when you modify the Pattern

- When this function is executed, the measure ([E]) will automatically move forward by the length of the Pattern.
- When you put/copy a Pattern into a measure, the data of that measure will be erased.
- If the destination Track contains musical data, the Pattern you put/copied will be played with the same time signature as the other Tracks.

☆ If the Base Resolution of the Song and Pattern are different, the Pattern data will be modified to the Song settings.

☆ When a Pattern is put into a measure, any control changes (other than volume) such as pitch bend which exist in that measure of the Track will be reset. In other words, if you want to apply pitch bend or damper to measures that were Put, you will have to write the data into the Pattern itself.

☆ If you put/copy by mistake, press the COMPARE key to restore the previous data before editing again.

- (1) Specify the Pattern to put ([B]).
 - (2) Specify the Track ([D]) and measure ([E]) into which the Pattern will be put or copied.
 - (3) To put the Pattern, press [PUT] ([G]). To copy the Pattern, press [CPY] ([H]).
- When creating a new Track, first set the Track program etc. in P0 REC/PLAY, and write the settings into memory.

Page-7 Edit Pattern

P7-1 Real Time Recording

SONG0 P7:PATTERN				▶Tempo					
▶Real Time Rec				Erase Pattern					
Step Recording				Get From Track					
Event Edit				Bounce Pattern					
Pattern Parameter				Copy Pattern					
P00		♩=144		M--		Q:HI		MM:ON	
A	B	C	D	E	F	G	H		

[A] P	Pattern Number	00 — 99	The Pattern to record
[B] ♩=	Tempo	40 — 240, EXT	Tempo
[C] M	Measure	00 — 99	Measure display
[D] Q:	Realtime Quantize	HI, ♩ 3 — ♩	Precision to which time will be corrected
[E] MM:	Metronome	OFF/ON/REC	Turn the metronome Off/On
[G]	Add / Remove	[ADD] [RMV]	Add data Remove data
[H]		[ERA]	Erase data

■ These settings allow you to record a Pattern in realtime.

- When creating a new Pattern or when you want to modify the beat or length of the Pattern, make settings in P7-4 Pattern Parameter.

- (1) Select the Pattern ([A]) to create. You may also select Patterns that were created by step recording, copy, etc.
- (2) Set the tempo ([B]), realtime quantize ([D]), and metronome On/Off/REC ([E]). These settings can also be modified after you start recording.
- (3) Press the REC/WRITE key to make the indicator light, and then press START/STOP to begin recording. In Pattern realtime recording, when the last measure of the Pattern ends, you will return to the first measure and recording will continue. The data of each pass will be added (overdubbed) to the previous data. (This is the same as when Loop Recording a song.) If you make a mistake, you can delete the incorrect data (see below).

• In Pattern realtime recording there are two ways to erase data.

- After starting the Pattern, press [ERA] ([H]), and all data existing over the time while the key is pressed will be erased.

- After starting, set Add/Remove ([G]) to "RMV". Press a key, and the data for that note will be removed while you continue pressing the note. While you apply an effect such as joystick or pitch bend, the data for that controller will be removed.

(4) Press START/STOP and recording will stop. To play the Pattern, start again without pressing REC/WRITE. To add data to the Pattern, repeat steps (3) — (4).

• In Pattern realtime recording, tempo settings and operations will not be recorded. Use any tempo that is comfortable for recording.

• While creating a Pattern, the Program of the currently selected Track will sound. (When a Pattern is put into a Track, it will use the Program of that Track.)

☆ Control data such as joystick or pedal data can also be recorded in a Pattern. However, be careful to return the controllers to their normal position before the end of the Pattern, to avoid “stuck” controllers or pedals. Also, remember that overdubbing several passes of the same control change can result in unnatural effects.

☆ When recording with a high resolution, a note you intended for the beginning of the Pattern will sometimes be recorded. In such cases, record using a lower resolution.

P7-2 Step Recording

SONG0 P7:PATTERN		▶Pattern Number					
Real Time Rec	Step Recording	Erase Pattern					
Event Edit	Pattern Parameter	Get From Track					
		Bounce Pattern					
		Copy Pattern					
Pattern00		(REC + S/S to Start)					
A	B	C	D	E	F	G	H

B	Pattern	00 — 99	The Pattern number to create
----------	---------	---------	------------------------------

* Press the REC/WRITE key, and then press the START/STOP key to select the Step Recording display.

SONG0 P7:Step REC		▶Beat					
Pattern = 00	-M001--Beat: 4/4 --						
Measure = 01	1:00 C3	U064 0:72					
Location = 3:00	2:00 D3	U064 0:72					
98% Free	3:00 E3	U064 0:72					
4/4		U064 075% [RST][TIE][◀]					
A	B	C	D	E	F	G	H

A	Beat	1/4 — 9/4 1/8 — 16/8 1/16 — 16/16 1/4 — 5/4 1/8 — 10/8 1/16 — 16/16	Display and set the time signature Low base resolution High base resolution
B	Step		The basic note length
C	Triplet / Dot	3 — •	Modification of the note length A triplet of note length specified by Step The note length specified by Step A dotted note of note length specified by Step
D	Key Dynamics	002 — 126, Key	Note velocity (002 — 126, key input)
E	Note Event Length	1 — 100 [%]	Note duration
F		[RST]	Enter a rest
G		[TIE]	Enter a tie (only when a note has been input)
H		[◀]	Go back one step

■ This is where you step record a Pattern.

- When creating a new Pattern or when you want to modify the time signature or length of the Pattern, make settings in P7-4 Pattern Parameter.
- (1) Specify the Pattern to record ([B]).
- (2) Press REC/WRITE to make the indicator light, and press START/STOP to begin step recording.
- (3) Follow the procedure explained in P5-1 Track Step Recording starting with step (4).
- In Pattern step recording, when the last measure of the Pattern ends, you will return to the first measure and

recording will continue. The data of each pass will be added (overdubbed) to the previous data.

- [RST] ([F]) and [TIE] ([G]) can be used as explained in P5-1 Step Recording.
- When you press [◀] ([H]), you will move back one step as specified by the step time, and any data which existed in that step will be erased. (See P5-1 Step Recording.) However if you press a note while holding [◀], only the the note you pressed will be deleted.
- When creating a Pattern, the Program of the Track selected in P0-1 Track will be used.

P7-3 Event Edit

SONG0 P7:PATTERN				▶Pattern Number			
Real Time Rec		Step Recording		Erase Pattern		Get From Track	
Event Edit		Pattern Parameter		Bounce Pattern		Copy Pattern	
Pattern00				(REC + S/S to Start)			
A	B	C	D	E	F	G	H

[B]	Pattern	00 — 99	The Pattern to edit
-----	---------	---------	---------------------

■ This function allows you to event edit a Pattern.

- (1) Select the Pattern to edit ([B]).
- (2) Press REC/WRITE to make the indicator light, and press START/STOP to begin event editing.
- (3) The remaining procedure is the same as explained in P5-3 Track Event Edit, starting with step (4).

P7-4 Pattern Parameter

SONG0 P7:PATTERN		▶Pattern Number
Real Time Rec	Step Recording	Event Edit
▶Pattern Parameter	Erase Pattern	Get From Track
	Bounce Pattern	Copy Pattern
[P00] Beat: 4/4 B.Res:Hi Length01 [SET]		
A	B	C
D	E	F
G	H	

[A] P	Pattern Number	00 — 99	The Pattern to edit
[B]	Pattern Beat	1/4 — 9/4 1/8 — 16/8 1/16 — 16/16 1/4 — 5/4 1/8 — 10/8 1/16 — 16/16	The time signature of the Pattern } Low base resolution } High base resolution
[D]	Pattern Base Resolution	Low, Hi	The timing resolution of the Pattern data
[F]	Pattern Length	01 — 99	Length of Pattern (number of measures)
[H]		[SET]	Set the specified Pattern parameters

■ These settings determine the time signature and length (number of measures) of each Pattern.

(1) Specify the Pattern ([A]) whose parameters you want to edit, and set the beat ([B]), resolution ([D]), and length ([F]).

- If the specified Pattern is used in a Track, the display will show the number of the Track in which that Pattern is used. (If you edit a Pattern which is being used in a Track, that Track may not play back correctly.)

- If the resolution is "Low", data will be recorded into the Pattern at a timing resolution of $\text{♩}/48$. If the resolution is "Hi", a finer timing resolution of $\text{♩}/96$ will be used, but fewer beat options will be available (specified in ([B])).
(2) Press [SET] ([H]) and the parameters will be set.

☆ If the Base Resolution of the Song and Pattern are different, the Pattern data will be modified to the Song settings.

P7-5 Erase Pattern

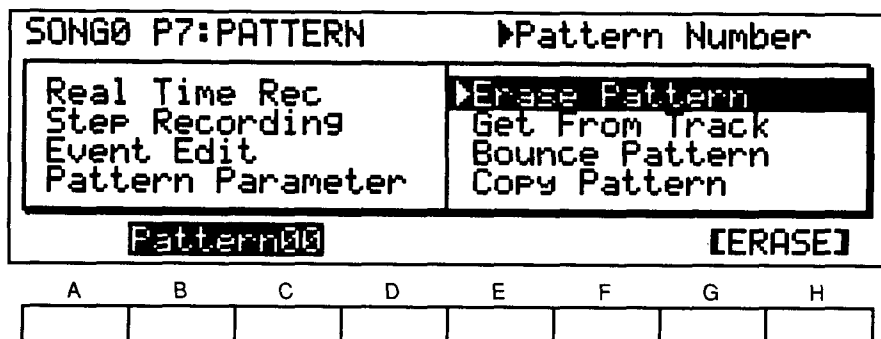

[B]	Pattern Number	00 — 99	The Pattern to erase
[G]		[ERASE]	Erase the Pattern

■ This operation erases a Pattern.

(1) Specify the Pattern ([B]) to be erased.

- If the specified Pattern is used in a Track, the display will show the number of the Track in which that Pattern is used.

(2) Press [ERASE] ([G]) to erase the Pattern.

☆ If you erase a Pattern by mistake, press the COMPARE key to restore the previous data before editing again.

P7-6 Get From Track

SONG0 P7:PATTERN		▶S0:New Song	
Real Time Rec	Erase Pattern		
Step Recording	▶Get From Track		
Event Edit	Bounce Pattern		
Pattern Parameter	Copy Pattern		
[S0]	Trk01 M001 →	P00	[GET]
A	B	C	D
E	F	G	H

[A] S	Source Song	0 — 9	The song from which to get measures
[B] Trk	Source Track	1 — 16	The Track from which to get measures
[C] M	Source Measure	1 — 999	The first measure to get
[E] P	Pattern	0 — 99	The Pattern into which data will be placed
[G]		[GET]	Execute the Get Pattern operation

■ This operation places data from a Track into a Pattern, allowing data recorded as a Track to be used in a Pattern. The number of measures that will be copied is determined by the length of the Pattern as specified in P7-4 Pattern Parameters.

(1) Specify the Song ([A]), Track ([B]), and measure ([C]) of the data, and the Pattern ([E]) into which the data will be copied.

(2) Press [GET] ([G]) to execute the operation.

☆ If you get a Pattern by mistake, press the COMPARE key to restore the previous data before editing again.

• If a note overlaps the specified range of measures, the tie will be deleted.

• The P7-4 Pattern Base Resolution and beat will be rewritten to the base resolution and beat of the song you get.

☆ Editing operations not available for Patterns (such as quantize, create control data, etc.) can be performed by copying the Pattern data to an empty Track, editing the data, and copying the data back to a Pattern.

* If the specified range of measures contains a Pattern which has been put, the display will ask you if wish to open the Pattern. Selecting "Yes" will open the Pattern, and selecting "No" will cancel the Put Pattern.

P7-7 Bounce Pattern

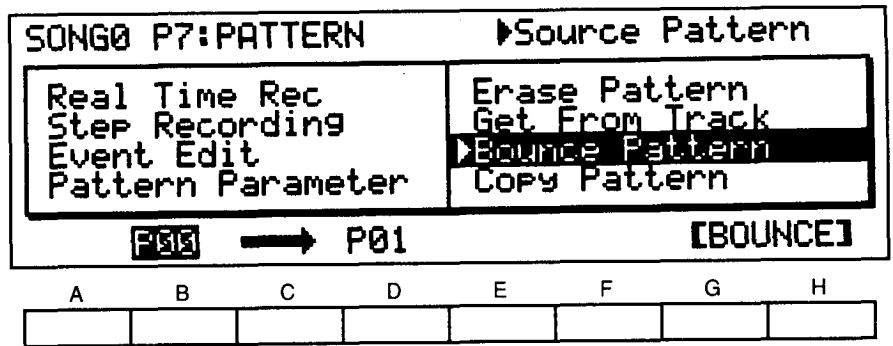

[B] P	Source Pattern	00 — 99	The source Pattern
[D] P	Dest Pattern	00 — 99	The destination Pattern
[G]		[BOUNCE]	Execute the Bounce operation

■ This operation combines the data of two Patterns into one Pattern.

- (1) Specify the source Pattern (the Pattern to bounce, [B]) and the bounce destination Pattern ([D]).
- (2) Press [BOUNCE] ([G]) to execute the operation.

- The combined data of both patterns will be placed in the destination Pattern.
- The time signature and length of the destination Pattern will be used for the newly combined data.

☆ If you Bounce by mistake, press the COMPARE key to restore the previous data before editing again.

P7-8 Copy Pattern

SONG0 P7:PATTERN				▶Source Pattern			
Real Time Rec Step Recording Event Edit Pattern Parameter				Erase Pattern Get From Track Bounce Pattern ▶Copy Pattern			
P00 → P01				[COPY]			
A	B	C	D	E	F	G	H

[B] P	Source Pattern	00 — 99	The source Pattern
[D] P	Dest Pattern	00 — 99	The destination Pattern
[G]		[COPY]	Execute the Copy operation

■ This operation copies a Pattern to another Pattern.

- (1) Specify the source Pattern (the Pattern to copy, [B]) and the copy destination Pattern ([D]).
- (2) Press [COPY] ([G]) to copy the Pattern.

- The time signature, length, and base resolution of the resulting Pattern will be determined by the source Pattern.

☆ If you Copy by mistake, press the COMPARE key to restore the previous data before editing again.

Page-8 Effect

For details of the following parameters, please refer to "Effect Parameters" (p.49).

SONG0 P8:EFFECT							
FX1 00:No Effect :OFF Mod:NONE I+00							
No Effect							
FX2 00:No Effect :OFF Mod:NONE I+00							
No Effect							
[SERIAL] Out3 = L Out4 = R							
A	B	C	D	E	F	G	H

- Pressing the Page+ key while a Song is playing will call up the Effect page, permitting you to edit any of the Effect parameters.
- If you wish to use effect settings from a Program or Combination, use the Copy Effect All operation (P9-4).

Page-9 Song**P9-1 Next Song**

SONG0 P9:SONG		▶ OFF					
▶ Next Song		Copy/Swap FX					
Rename Song		Copy from Combi					
Metronome		Base Resolution					
Copy Effects All							
Next: OFF		[STOP]					
A	B	C	D	E	F	G	H

[B]	Next Song	OFF / 0 — 9	Specify the Song to be played next
[F]		[STOP] [PLAY]	Select the next Song and stop Continue playing the next song

■ This function allows you to specify a Song to be selected (and played) when the currently selected Song ends.

- When Next Song is set to "OFF", playback will end when that song has been played back, but when set to "0—9", the specified song will be selected.
- When set to STOP, playback will stop at the beginning of the specified Song.

- When set to PLAY, playback will continue with the specified Song.

☆ When set to PLAY, there may be a slight delay when the Song is selected.

P9-2 Rename Song

SONG0 P9: SONG							
Next Song	ABCDEFGHIJKLMN O P Q R S T U V W X Y Z						
Rename Song	abcdefghijklmnopqrstuvwxyz						
Metronome	0123456789@! " # \$ % & ' ,						
Copy Effe	()*+, `-. / : ; < = > ? [\] ^ _ { } ~						
S0: ShowGoose [INS] [DEL] [◀] [▶]							
A	B	C	D	E	F	G	H

[E]	[INS]	Insert one character at the rename cursor position
[F]	[DEL]	Delete one character at the rename cursor position
[G]	[◀]	Move the cursor left
[H]	[▶]	Move the cursor right

▼This function sets the Song name.
Pressing [INS] will insert one copy of the character at the cursor position to the right of the cursor position. Pressing [DEL] will delete the character at the cursor position.

▼This operation rewrites the song name.
- Use [◀] (cursor key [G]) and [▶] (cursor key [H]), [INS] (cursor key [E]), [DEL] (cursor key [F]), the VALUE slider, and the △ / ▽ keys to set the Song name.
- Each Song can be given a ten-character name.

P9-3 Metronome

SONG0 P9: SONG		▶Lead In					
Next Song	Copy/Swap FX						
Rename Song	Copy from Combi						
Metronome	Base Resolution						
Copy Effects All							
L.In=2	Level=99	Pan=5:5					
A	B	C	D	E	F	G	H

[B]	Lead In	0 — 2	Number of measures for the lead-in (the number of measures until recording begins)
[D]	Metronome Level	00 — 99	Metronome volume
[F]	Metronome Panpot	A, 9:1 — 1:9, B, C, C+D, D, ALL	Panpot for the metronome sound

These settings determine how the metronome will sound for each Song.

• Lead In ([B]) specifies the number of measures which the metronome will countdown before recording begins when you start realtime recording; i.e, the number of measures before recording actually begins.

• The metronome volume ([D]) and panpot ([F]) can also be set. When "ALL" is selected, the sound will appear at all outputs A, B, C, and D.
• Using the metronome will decrease the simultaneous note capability of the 01/WFD•01/W by one note.

P9-4 Copy Effects All

SONG0 P9: SONG				▶Source Mode			
Next Song				Copy/Swap FX			
Rename Song				Copy from Combi			
Metronome				Base Resolution			
▶Copy Effects All							
from [SONG]				- S10		[COPY]	
A	B	C	D	E	F	G	H

[B]		PROGRAM COMBINATION SONG	Copy from a Program Copy from a Combination Copy from a Song
[E]		A00 — B99 / C00 — D99 A00 — B99 / C00 — D99 S10—S19, SC0—SC9, SD0—SD9	The Program from which to copy The Combination from which to copy The Song from which to copy
[G]		[COPY]	Execute the Copy operation

■ This operation copies only the Effect parameters from a Program Combination or a Song.

- The data will be copied into the Song currently being edited.

(1) Select the mode containing the memory whose Effect parameters you want to copy ([B]).

(2) Select the number you want to copy. (When copying from a Song, select the Song number; when copying from a Program, select the Program number; when copying from a Combination, select the Combination number.)

(3) Press [COPY] ([G]) to copy the effect parameters from the specified memory.

P9-5 Copy/Swap FX

SONG0 P9: SONG				▶Direction			
Next Song				▶Copy/Swap FX			
Rename Song				Copy from Combi			
Metronome				Base Resolution			
Copy Effects All							
FX1 → FX2						[COPY]	
A	B	C	D	E	F	G	H

[A]		FX1 → FX2 FX1 ← FX2 FX1 ↔ FX2	Copy FX1 → FX2 Copy FX1 ← FX2 Exchange FX1 ↔ FX2
[G]		[COPY]	Execute the Copy/Swap operation

■ This operation copies/exchanges effect parameters between effects 1 and 2.

This operation is the same as the Copy/Swap FX for the EDIT PROGRAM and EDIT COMBINATION modes.

P9-6 Copy from Combination

SONG00 P9: SONG				▶A00: Organ			
Next Song				Copy/Swap FX			
Rename Song				▶Copy from Combi			
Metronome				Base Resolution			
Copy Effects All							
from A00: Organ				to Trk1-8 [COPY]			
A	B	C	D	E	F	G	H

[B]	Source Combination	A00 — B99 / C00 — D99	The Combination from which to copy
[E]	Destination Tracks	Trk 1 — 8, Trk 9 — 16	The copy destination Track
[G]		[COPY]	Execute the Copy operation

■ This operation copies Timbre settings from the selected Combination to the song parameter data for tracks 1 — 8 or tracks 9 — 16.

- This operation will copy the settings for program, volume, transpose, detune, panpot, key window, velocity window, MIDI channel and Timbre mode (track status), and the effect parameter settings. Other song parameters will not be affected.
- Be aware that the way in which MIDI OUT etc. is handled differs somewhat between Combination mode and Sequencer mode.

- In order to use a Combination in the sequencer, you must use a Track for each Timbre (Program). If the MIDI channels match, the Programs will sound simultaneously. There is no copy the same data to the other tracks.

- (1) Select the Combination from which you want to copy the data ([B]).
- (2) Select the copy destination tracks (1 — 8 or 9 — 16) ([E]).
- (3) Press [COPY] ([G]) to execute the operation.

P9-7 Base Resolution

SONG0 P9: SONG				▶Base Resolution			
Next Song				COPY/SWAP FX			
Rename Song				COPY from Combi			
Metronome				▶Base Resolution			
COPY Effects All							
Base Resolution : High(1/96) [SET]							
A	B	C	D	E	F	G	H

[A]	Base Resolution	Low, High	Specify the Base Resolution
[G]		[SET]	Set

■ This function specifies the smallest unit of timing for musical data in a song.

- When "Low" is selected, recording and editing will use a timing resolution of 1/48th of a quarter note.
- When "High" is selected, recording and editing will use a timing resolution of 1/96th of a quarter note, but fewer options will be available for the time signature.

Beats for Base Resolutions

Base Resolution	Beat
Low	1/4 — 9/4
	1/8 — 16/8
	1/16 — 16/16
High	1/4 — 5/4
	1/8 — 10/8
	1/16 — 16/16

- When you set the realtime recording parameter P0-1 Realtime Quantize to "HI", or the resolution of P6-1 Quantize to "HI", quantization will be performed using the timing resolution you specify here.
- The location in P5-1 Step Recording, P5-2 Create Control Data, and P5-3 Event Edit will advance in steps of 2 if this setting is "Low", and in steps of 1 if this setting is "High".
- * Be aware that once you have recorded with this setting, it cannot be changed for the song unless you erase the entire song using the P5-7 operation.

7. GLOBAL MODE

In this mode you can make settings that affect the entire 01/WFD•01/W (overall tuning, and MIDI-related settings), and assign drum sounds to a Drum Kit.

- With the exception of some MIDI-related parameters (clock source, local, note receive), settings made in this mode are memorized even when the power is turned off. It is not necessary to write these settings into memory.

FUNCTIONS IN GLOBAL MODE

- Use the numeric keys and the PAGE+ and PAGE- keys to select the page containing the parameter you want to edit.

Page	Function	Parameters to set
P0 GLOBAL 1	0-1 LCD Contrast, Effect ON/OFF 0-2 Master Tune, Key Transpose 0-3 MIDI Channel, Clock Source 0-4 Local, Note Receive 0-5 MIDI Filtering	Adjust the contrast of the LCD, Effect switch ON/OFF Overall pitch adjustment, overall transposition Specify MIDI global channel, MIDI clock Local on/off, filter note data Transmission / reception switches for each type of MIDI message
P1	Drum Kit 1	Assign drum sounds
P2	Drum Kit 2	Assign drum sounds
P3	Scale Type / User Scale	Set the scale type and the user scale
P4 GLOBAL 2	4-1 Damper Switch Polarity 4-2 Pedal 1 Assign 4-3 Pedal 2 Assign 4-4 Velocity Curve, Aft Touch Curve 4-5 Prog. Protect, Combi Protect, Seq. Protect	Specify the polarity of the damper footswitch Specify the polarity of the assignable pedal 1 Specify the polarity of the assignable pedal 2 Velocity curve and aftertouch curve settings Memory protect (Program, Combination, Sequencer)
P5	Load Card	Load from PROG/SEQ card
P6	Save Card	Save to PROG/SEQ card
P7	Preload	Load preload data
P8	MIDI Data Dump	Transmit various parameters and sequence data as MIDI exclusive messages

GLOBAL

Page-0 Global-1

GLOBAL P0:GLOBAL				▶LCD Contrast			
LCD Contrast = 3				Effect : ON			
Master Tune = +00				Key Transpose = +00			
MIDI Channel : 01				Clock Source : INT			
Local Control : ON				Note Receive : ALL			
MIDI Filter				PROG:ENA		AFTT:ENA	
				CTRL:ENA		EXCL:DIS	
A	B	C	D	E	F	G	H

P0-1 LCD Contrast

[A]	LCD Contrast	1 — 8	Adjust the contrast of the LCD
[E]	Effect SW	OFF, ON	Effect ON/OFF switch

▼LCD Contrast adjusts the contrast of the display. A setting of 1 is the lightest, and 8 is the darkest.

▼When Effect SW (effect switch) is set to OFF, all effects are disabled.

P0-2 Master Tune / Key Transpose

[A]	Master Tune	-50 — +50	Adjust the overall pitch of the 01/WFD•01/W (steps of 1 cent)
[E]	Key Transpose	-12 — +12	Transpose the overall pitch of the 01/WFD•01/W (chromatic steps)

* These parameters determine the pitch of the entire 01/WFD•01/W.

▼Master tune adjusts the tuning of the entire 01/WFD•01/W over a range of ± 50 cents. Use this when tuning the 01/WFD•01/W to other instruments.

• The tuning selected on the 01/WFD•01/W is not transmitted from MIDI OUT, but the MIDI RPC Master Tune setting can be output from an external device.

▼Key transpose adjusts the pitch of the entire 01/WFD•01/W over a range of ± 1 octave, in chromatic steps (-12 — +12). This can be useful when you need to play songs of a difficult key signature in an easier key.

- This setting applies to the data that is recorded by the sequencer, and to the data that is transmitted from MIDI OUT. However, data played back by the sequencer will not be affected by this setting.

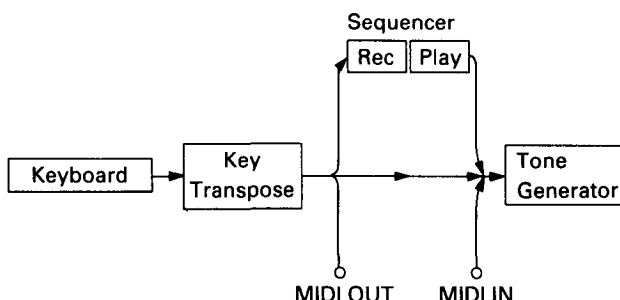

P0-3 MIDI Channel / Clock Source

[A]	MIDI Channel	1 — 16	Select the channel on which the 01/WFD•01/W will receive or transmit data (Global channel)
[E]	Clock Source	INT / EXT	Specify whether or not the sequencer will receive and transmit MIDI clock messages

▼MIDI channel determines the transmission and reception channel for musical data in Program mode, Combination changes in Combination mode, and for system exclusive data. (When the MIDI Filtering parameter “Prog” is set to “PRG”, Combinations cannot be selected via MIDI). (This MIDI channel is called Global channel, and it controls the entire 01/WFD•01/W).

- Musical data in all timbres used in Combinations and in all Tracks used in Sequencer songs will be transmitted on the channels specified in Edit Combination mode and Sequencer mode.

▼If you want to receive MIDI clock data from an external sequencer etc. to determine the playback tempo, set Clock Source to “EXT”. (The 01/WFD•01/W internal tempo settings will have no effect.) Use this setting when synchronizing the 01/WFD•01/W to an external device.

- If this is set to “INT”, MIDI clock data will be transmitted from MIDI OUT while the 01/WFD•01/W is in sequencer mode, allowing you to synchronize external devices to the 01/WFD•01/W.
- If no MIDI device is connected to MIDI IN, be sure to set this to “INT”.
- Start, stop, continue, song select, and song position messages will be received from external MIDI devices only if this is set to “EXT”.
- When the power is turned on, this will be set to “INT”.

P0-4 Local

[A]	Local Control	OFF/ON	MIDI local mode switch
[E]	Note Receive	EVEN, ODD, ALL	Note data filter

▼When local control is set “Off”, the 01/WFD•01/W’s keyboard and controllers (joystick, aftertouch, etc.) will be disconnected from its tone generator. (However, MIDI data will still be transmitted and received.) Normally you will leave this set “ON”.

- When local control is set “Off”, the sequencer will transmit and receive only MIDI data.
- When the power is turned on, this will be “On”.

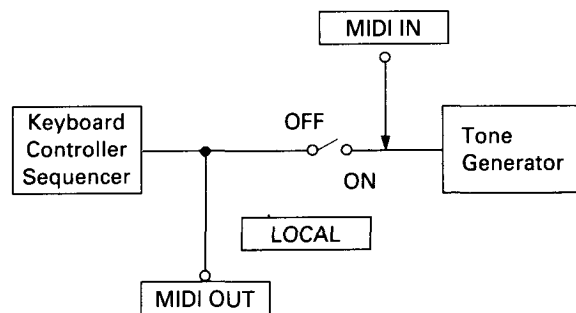

▼Note Receive determines the data to be filtered. (EVEN: Notes with an even number will sound. ODD: Notes with an odd number will sound.) The data from MIDI OUT will not be filtered.

- When you have a MIDI connection between two 01/WFD•01/W, this can be used to double the voice data being sounded. This is normally set to ALL.
- “ALL” is the default setting when the power comes on.

P0-5 MIDI Filtering

<input type="checkbox"/> D PROG	Combination / Program Change	DIS, ENA, PRG, NUM	When set to "DIS", the specified type of MIDI data will neither be transmitted nor received.
<input type="checkbox"/> F AFTT	After Touch	DIS, ENA	
<input type="checkbox"/> D CTRL	Control Change	DIS, ENA	When set to "DIS", the specified type of MIDI data will neither be transmitted nor received.
<input type="checkbox"/> F EXCL	Exclusive	DIS, ENA	

* These parameters allow you to disable reception and transmission of specified types of MIDI data. (This is known as "filtering".)

☆ Data will be filtered when it is recorded by the sequencer, but not when it is played back.

▼ If Combination / Program Change is set to "DIS", Combination (Program) changes will neither be transmitted nor received. If set to "ENA", in Combination mode, incoming program change messages on the Global channel will select Combinations. However if set to "PRG", the Combination will not change, but Timbres of the matching channels in the Combination will change Programs. Refer to "Program Change Filtering" at the end of this manual.

- Select ENA if you want to use MIDI Program Change to change and then play Combinations.
- Use PRG if you want to use MIDI Program Changes to change and then play a Program used in a Timbre of a single Combination. Select NUM if you do not want to change the Bank using MIDI Bank Change.

▼ If Control Change is set to "DIS", control change messages (pitch bend, volume, joy stick, etc.) will neither be transmitted nor received.

▼ If After Touch is set to "DIS", aftertouch data will not be received.

- Signals are sent and received only when the 01/WFD•01/W is set to Channel Aftertouch. Refer to MIDI MINI TEXT (P9) for more details.

▼ If Exclusive is set to "DIS", system exclusive messages for parameter changes will neither be transmitted nor received.

◇ System exclusive parameter changes are used by personal computer voice editing programs.

When two 01/WFD•01/Ws are connected and Exclusive is set to "ENA", you will be able to simultaneously edit the voice data of both units.

- When the 01/WFD•01/W is connected to a different type of MIDI device, set this to "DIS".

Page-1 Drum Kit 1

Page-1 Drum Kit 1

GLOBAL P1: DRUM KIT A1 ▶ScratchDbl							
#21	056	D5	+000	L+40	D+00	5:5	EX4
#22	037	D#4	+000	L+90	D+00	5:5	---
#23	036	D4	+000	L+80	D+00	5:5	---
#24	070	F5	-058	L+20	D-55	7:3	EX2
#25	072	G5	-095	L+15	D-33	3:7	EX2
#26	055	F4	+000	L+07	D-60	5:5	---

A	B	C	D	E	F	G	H

A #	Index	0 — 59	Index which assigns the drum sound you wish to edit
B	Inst	—, 000 — 118, C00 —	Select a drum sound
C	Inst Key	C0 — G8	Key assigned to drum sound
D	Inst Tune	-120 — +120	Pitch adjustment of ± 1 octave
E L	Inst Level	-99 — +99	Level adjustment for each sound
F D	Inst Decay	-99 — +99	Decay time adjustment for each sound
G	Pan	A, 9:1—1:9, B, C, C+D, D, ALL	Output selection
H	Exclusive Assign	—, EX1 — EX9	Set exclusive assign group

* This is where you edit the Drum Kit used as a sound source by a Program in Drum Kit mode. Up to 60 types of drum sounds can be assigned to the 4 Drum Kit.

There are two Drum Kits available in each bank, but when editing a kit in the Global mode, the drum kit must be from the bank selected for the Program in the Program mode. For example, when editing a drum kit from Bank B, first select a Program (one which uses the drum kit you want to edit) from Bank B in the Program mode, then move to the Global mode.

- When you play the keyboard in this page, the parameters of the Program selected in Program mode will be used.
- When the corresponding Program parameter is modified, the Volume etc. of the entire Drum Kit will be affected.

- Other Program parameters will also affect the entire Drum Kit.

In other words, if a Program with (for example) a slow attack has been selected, the drum kit will not sound correctly. If the drum sound is assigned to C, C+D, or D, and the Program mode setting Effect Pans 3 and 4 of the Program are turned off, there will be no sound from 1/L, 2/R, or the headphones.

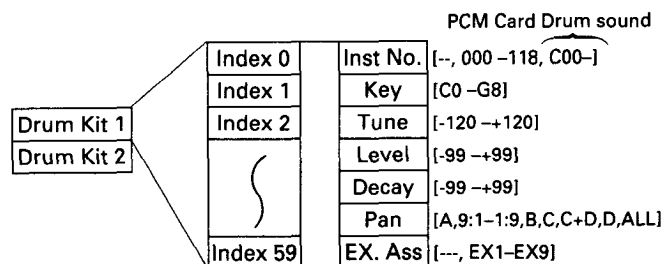

▼Index selects the drum index to edit. You can think of the Index as being a container in which a single drum is placed.

When the Index value is being changed and the cursor UP (DOWN) key is pressed while in the top (bottom) line, the screen will be scrolled.

- An index for which no drum sound is assigned will be indicated by "No Assign" in the upper right corner of the display.

☆While pressing the cursor key **[A]**, press a key, and the Index assigned to that key will be selected.

▼Inst is where you select the drum sound used by that index. (The end of this manual contains a list of the drum sounds.)

- If an optional PCM card containing drum sounds has been inserted, card sounds can also be selected using the VALUE slider. When using the numeric keys, use the 10's HOLD/-key. (When playing Programs which use PCM card drum sounds, be sure that the appropriate card is inserted.)

- Select "No Assign" for each Index which you don't need to assign, and set Key (**[C]**) to an unused key.

▼Key determines the key (C0 — G8) assigned to that index. (The note name for an octave setting of 8' will be displayed.)

- You will not be able to select keys which have already been assigned to another drum sound.

- You can assign a single drum sound to be played by more than one key.

- Keys which have not been assigned a drum sound will automatically be given the sound assigned to the next higher key. (However the pitch will change according to the scale.)

- You can also make key settings from the keyboard. While pressing cursor key **[C]**, press a key, and the selection will be input when you release the cursor key.

ex.

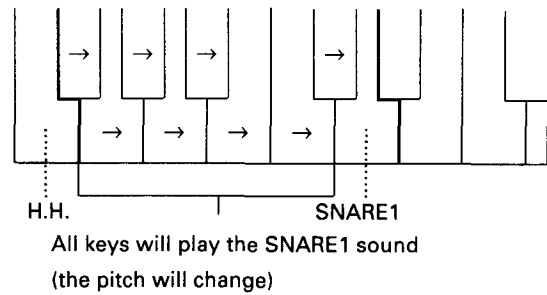

▼Tune adjusts the pitch of an assigned key over a range of -120 — +120 (in steps of 10 cents, ±1 octave).

▼Level is an adjustment relative to the oscillator level setting in program mode, over a range of -99 — +99.

▼Decay is an adjustment relative to the VDA EG decay setting in Program mode, over a range of -99 — +99.

▼Pan specifies the output; A, A:B (9:1 — 1:9), B, C, C+D, D.

▼Exclusive Assign is used to assign sounds. If an Index sound in a group specified by EX1-9 is played, other sounds specified for the same group will not be sounded. This results in a monophonic sound. For example, this would be used if you want to create a hi-hat open and close sound simultaneously. When this setting is - - -, a polyphonic sound is made without regard for the group.

Page 2 Drum Kit 2

* Details are the same as for Page 1 Drum Kit 1.

Page-3 Scale Type / User Scale

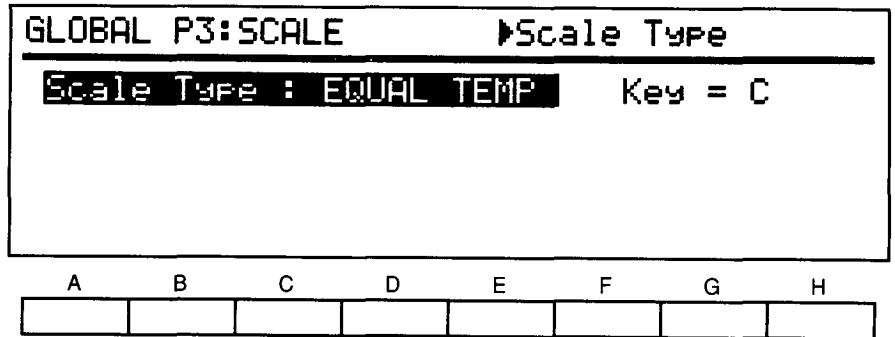

P3-1 Scale Type / Pure Key

<p>[A]</p>	<p>Scale Type</p>	<p>EQUAL TEMP EQUAL TEMP 2 PURE MAJOR PURE MINOR USER SCALE</p>	<p>Equal temperament Each time a key is pressed, the pitch will be given a slight random deviation from equal temperament Pure major scale Pure minor scale A scale with user-specified pitch for each note</p>
<p>[G] Key</p>	<p>Pure Key</p>	<p>C, C#, ... A#, B</p>	<p>The tonic used for pure temperament</p>

* This specifies the basic temperament used by the 01/WFD.

▼EQUAL TEMP: This is the temperament most widely used by keyboard instruments. Pitch intervals are not affected by transposition.

▼EQUAL TEMP 2 (equal temperament with random pitch): This adds a slight amount of random pitch variation to equal temperament. It is useful when simulating instruments that have natural irregularity in pitch.

▼PURE MAJOR: Pure temperament is designed so that chords in a specific tonic are as harmonious as possible. You can specify a tonic of C — B.

▼PURE MINOR: Specify a tonic of C — B.

▼USER PROGRAMMABLE: This allows you to adjust each of the 12 pitches in the equal tempered scale over a range of ± 50 cents, to create your own original temperament. Specify the pitch of each key in P3-2 User Scale.

* Pure Key settings are valid only when the Scale Type is "PURE MAJOR" or "PURE MINOR".

P3-2 User Scale

Change with cursor Up/Down keys

UP
↓
DOWN

GLOBAL P3:SCALE ▶Scale Type

Scale Type : USER SCALE Key = C

	+00	+00		+00	+00	+00	
+00	+00	+00	+00	+00	+00	+00	+00

A B C D E F G H

--	--	--	--	--	--	--	--

	DOWN	UP		
[A]	C	C [#] (D ^b)	-50 — +50	Pitch offset (in cents) for each note of the equal tempered scale
[B]	D		-50 — +50	
[C]	E	D [#] (E ^b)	-50 — +50	
[D]	F		-50 — +50	
[E]	G	F [#] (G ^b)	-50 — +50	
[F]	A	G [#] (A ^b)	-50 — +50	
[G]	B	A [#] (B ^b)	-50 — +50	

- These settings determine the pitch of each scale degree when the Scale Type is set to "User Scale".
- Use the cursor UP/DOWN keys and the cursor keys ([A] — [H]) to select the key to set.
- These settings for the 12 notes will be extended over the entire range (in each octave) of the 01/WFD•01/W.

Page-4 GLOBAL-2

GLOBAL P4:PROTECT		▶Damper Polarity					
Damper Sw Polarity : -							
Assignable Pedal 1 : Program Up		Aft.Touch Curve=4					
Assignable Pedal 2 : Volume		Seq:OFF					
Velocity Curve=4		Combi:OFF					
Protect Prog:OFF		Seq:OFF					
A	B	C	D	E	F	G	H

P4-1 Damper Switch Polarity

	Damper Switch Polarity	+, -	Select the polarity of the footswitch connected to the damper jack
--	------------------------	------	--------------------------------------------------------------------

* The damper switch is used as a damper switch or hold pedal. While it is depressed, released notes will continue sustaining as though they had not been released.

▼Damper Polarity selects the polarity of the damper foot switch. When using $\overline{\text{A}}$ types of footswitch such as the Korg PS-1, set this to “-”. When using other types of footswitch $\overline{\text{B}}$, set this to “+”.

- If a damper switch is not connected, set this to “-”.

P4-2 Pedal 1 Assign

	Pedal 1	<p style="text-align: center;">OFF</p> <p style="text-align: center;">Program Up Program Down SEQ Start/Stop SEQ Punch In/Out Effect On/Off Volume VDF Cutoff Effect Control</p> <p style="text-align: center;">Data Entry</p>	<p>The function assigned to Pedal 1</p> <p>Not used</p> <p>A footswitch will increment the Program (Combination)</p> <p>A footswitch will decrement the Program (Combination)</p> <p>A footswitch will start/stop the sequencer</p> <p>A footswitch will punch in/out when recording</p> <p>A footswitch will turn Effect on/off</p> <p>A foot controller will regulate Volume</p> <p>A foot controller will regulate VDF Cutoff</p> <p>A foot controller will regulate the dynamic modulation source of Effect</p> <p>A foot controller will function as a data entry control</p>
--	---------	------------------------------------------------------------------------------------------------------------------------------------------------------------------------------------------------------------------------------------------------------------	------------------------------------------------------------------------------------------------------------------------------------------------------------------------------------------------------------------------------------------------------------------------------------------------------------------------------------------------------------------------------------------------------------------------------------------------------------------------------------------------------------------------------------------------------------------------------------

▼These select the functions assigned to Pedal 1 and Pedal 2.

- Depending on the type of function that is selected, connect either a Footswitch (on/off type) or a Foot Controller (continuous type) to the Pedal 1/2 jack.
- The actual control range of the foot controller will be determined by various parameter settings for the function being controlled.
- * Program (Combination) Up: A footswitch will select the next Program (Combination). At this time, a program change message will be transmitted from MIDI OUT.
- * Program (Combination) Down: A footswitch will select the previous Program (Combination). At this time, a program change message will be transmitted from MIDI OUT.
- * SEQ Start/Stop: A footswitch will alternately start and stop the sequencer. Start/stop messages will be transmitted from MIDI out.

- * SEQ Punch In/Out: A footswitch will alternately start and stop the sequencer during manual punch in recording.
- * Effect 1 On/Off: A footswitch will turn effect 1 on/off. The Effect 1 on/off setting is output via MIDI OUT.
- * Effect 2 On/Off: A footswitch will turn effect 2 on/off. The Effect 2 on/off setting is output via MIDI OUT.
- * Volume: A foot controller will control the volume of the 01/WFD*01W. Volume change messages will be transmitted from MIDI OUT.
- * VDF Cutoff: A foot controller will regulate VDF cutoff frequency (tone). As you advance the pedal, the cutoff frequency will rise (the sound will become brighter).
- * Effect Control: Select this when you wish to use a foot controller to dynamically control an effect. Set the Dynamic Modulation Source of the effect to be controlled by "PEDAL 1(2)". When Pedal 1 (2) is operated, Effect control 1 (2) is output via MIDI OUT. When Pedal 1 (2) is operated, Effect control 1 (2) is output via MIDI OUT.

P4-3 Pedal 2 Assign

- Contents are the same as for P4-2 Pedal 1 Assign. This is used to select functions to be assigned to Pedal 2.

* Data Entry:

A foot controller will perform the same function as the front panel VALUE slider. During a performance, you can use the cursor keys to select the parameter you wish to modify, and then use the foot controller to control the value of the selected parameter.

☆ Be sure to connect either a footswitch or a foot controller, as appropriate for the function you have assigned. If no pedal or footswitch is connected to the pedal jacks, assign them to either OFF, Program Up, Program Down, or Effect ON/OFF.

◇ Footswitches must be of the  type, such as the Korg PS-1.

◇ Please use a Korg EXP-2 foot controller for continuous pedal functions.

P4-4 Vel / Aft.T Curve

[A]	Velocity Curve	1 — 8	Select the velocity curve; i.e., the way in which key velocity (how hard you play a note) will affect volume or tone.
[E]	After Touch Curve	1 — 8	Select the aftertouch curve; i.e., the way in which aftertouch (how hard you press down after playing a note) will affect volume or tone.

▼ Velocity Curve allows you to select one of 8 curves to determine how key velocity will affect volume or tone.

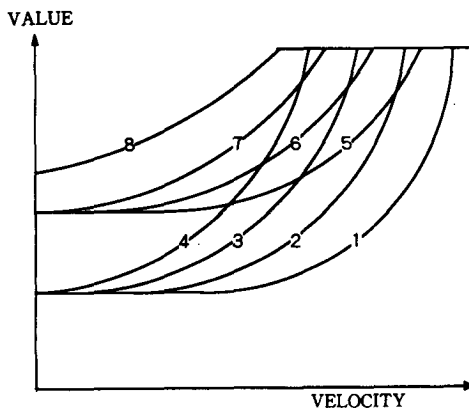

- The velocity / aftertouch curves specified here will apply to the data transmitted from MIDI OUT, but will have no effect on the data received from MIDI IN.

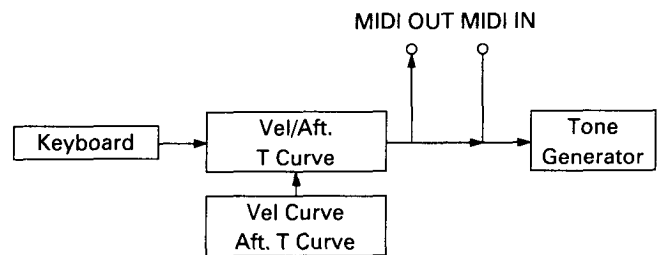

▼ After Touch Curve allows you to select one of 8 curves to determine how aftertouch will affect volume or tone.

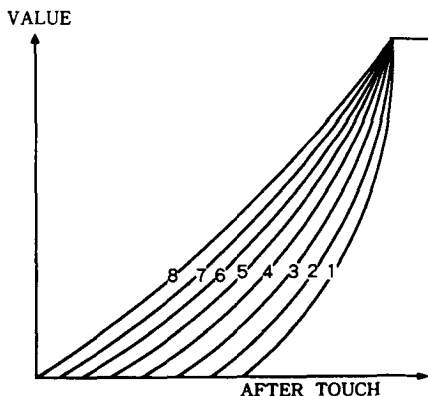

P4-5 Program Memory Protect / Combination Memory Protect / Sequencer Memory Protect

C	Program Memory Protect	OFF/ON	Memory protect for Program parameters in internal memory
E	Combination Memory Protect	OFF/ON	Memory protect for Combination parameters in internal memory
G	Sequencer Memory Protect	OFF/ON	Memory protect for internal Sequence data

▼When Program Memory Protect is set “ON”, it will not be possible to write Program parameters into Banks A and B in the internal memory.

▼When Combination Memory Protect is set “ON”, it will not be possible to write Combination parameters into Banks A and B in the internal memory.

▼When Sequencer Memory Protect is set “ON”, it will not be possible to write data into sequencer memory.

* There is a protect switch on each RAM card, allowing you to prevent data from being accidentally overwritten.

Program Card loading and saving

When you use a new card, first save the data for each bank onto the card in one of P6-1-2. This operation will format the card for each bank, and will allow you to load data (in P5-1-7), and read and write Programs and Combinations to in the Program mode and Combination mode.

These functions load and save data on a PROG/SEQ (ROM/RAM) card.

- The following groups of parameters can be Loaded (into internal memory).

100 Combinations / 100 Programs / 4 Drum Kits / Global parameters (P5-1)

All sequence data (P5-2)

1 Combination (P5-3)
 1 Program (P5-4)
 1 Drum Kit (P5-5)
 1 Song (P5-6)
 1 Pattern (P5-7)

- The following groups of parameters can be Saved (written into a card).

100 Combinations / 100 Programs / 2 Drum Kits / Global parameters (P6-1)

All sequence data (P6-2)

- On the 01/WFD, it is not possible to save Sequence data on a RAM card unless the sequence data memory is 86% or more free. If sequence data memory is less than 86% free, save the data to disk.
- ☆ Use a Korg "SRC-512" Memory Card RAM (512K Bits).
- Loading data into internal memory will overwrite the data previously in internal memory.
- Saving data into a card will overwrite the data previously in the specified bank of that card.
- It is not possible to load if Memory Protect is turned On. (Turn off memory protect in Global mode.) Turn on memory protect with the card protect switch.
- For details, refer to "How memory is organized" at the end of this manual.
- * On a PROG/SEQ card, one bank can accommodate 256 Kbits of data. Therefore, a card with a capacity of 512 Kbits (such as a RAM card) contains Bank C and Bank D.

Page-5 Card Load

P5-1 Card Load All Combi / Prog / Drums / Global

GLOBAL P5: CARD LOAD				▶Combi/Prog/Drum			
▶Load Combi/Prog	Load 1 Drum Kit						
Load All Sequence	Load 1 Song						
Load 1 Combi	Load 1 Pattern						
Load 1 Prog							
Bank-C+D → Bank-A+B						[LOAD]	
A	B	C	D	E	F	G	H

[A]	Source Card Bank	C+D, C, D	Specify the bank to load
[D]	Destination Bank	A+B, A, B	Specify the bank to which data will be loaded
[G]		[LOAD]	Execute loading

▼This operation loads 100 Combinations, 100 Programs, 2 Drum kits, and Global parameters from the specified bank of a ROM/RAM card into internal memory.

- (1) Specify the Bank ([A]) of the card from which you will load the data.
- (2) Specify the load destination of Bank D.
Data for two banks is loaded at one time when you select C + D as the loading bank and A + B as the load destination bank. (Both banks C and D must contain Program/Combination data.) In this situation, data from bank C is loaded to A, and data from bank D is loaded to B.

- (3) Press [LOAD] ([G]), and the display will ask whether you are sure you want to load. To load the data press [YES] ([E]). To quit without loading press [NO] ([G]).

☆When data is loaded to Bank A, the Global settings will be changed to the values which have been saved from the card. The LCD contrast and memory protect status will remain unchanged.

☆After loading, the Program banks within a Combination will be changed from C and D (card) to A and B (internal memory). When loading from Bank C to A or from Bank D to B, the Program bank within the Combination will also change from C to A or from D to B. When loading is done from C to B or from D to A, the Program bank will likewise change from C to B or from D to A.

P5-2 Card Load All Sequence

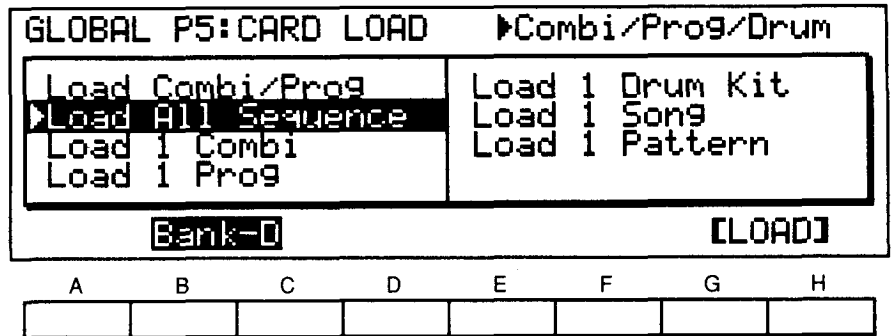

[A]	Card Bank	C, D	Specify the bank to load
[G]		[LOAD]	Execute loading

▼This operation loads all sequence data from the specified bank of a ROM/RAM card into internal memory.

(1) Specify the Bank ([A]) of the card from which you will load the data.

(2) Press [LOAD] ([G]), and the display will ask whether you are sure you want to load. To load the data press [YES] ([E]). To quit without loading press [NO] ([G]).

* After loading, the Program bank for each Track will be changed, from C to A, and from D to B.

P5-3 Card Load 1 Combination

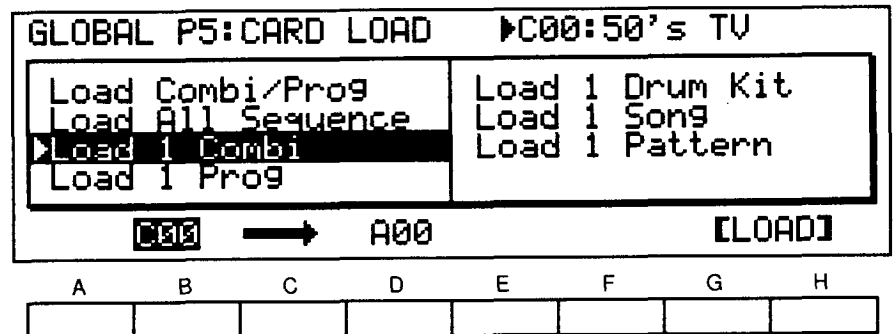

[A]	Card Combination	C00 — D99	Specify the Combination to be loaded from the card
[D]	Internal Combination	A00 — B99	Specify the internal memory into which the Combination will be loaded
[G]		[LOAD]	Execute loading

▼This operation loads a Combination from a card.

• You will need to use the P5-4 Card Load 1 Program operation to load each Program used by the card Combination.

(1) Specify, the Combination on the card ([A]) and the loading destination of the Combination ([D]). The combination name will be displayed in the upper right position.

(2) Press [LOAD] ([G]), and the display will ask whether you are sure you want to load. To load the data press [YES] ([E]). To quit without loading press [NO] ([G]).

* After loading, the Program bank for each Timbre will be changed, from C to A, and from D to B.

P5-4 Card Load 1 Program

GLOBAL P5: CARD LOAD		▶C00:096		Pizz			
Load Combi/Prog	Load 1 Drum Kit	Load All Sequence	Load 1 Song	Load 1 Combi	Load 1 Pattern		
▶Load 1 Prog							
C00		→		A00			
				[LOAD]			
A	B	C	D	E	F	G	H

[A]	Card Program	C00 — D99	Specify the Program to be loaded from card
[D]	Internal Program	A00 — B99	Specify the internal memory into which the Program will be loaded
[G]		[LOAD]	Execute loading

▼This function loads a Program from a card.

(1) Specify the Program ([A]) on the card and the loading destination of the Program ([D]).

(2) Press [LOAD] ([G]), and the display will ask whether you are sure you want to load. To load the data press [YES] ([E]). To quit without loading press [NO] ([G]).

* After loading a Drum program, the Drum Kit used will be changed to one from the bank at the load destination.

P5-5 Card Load 1 Drum Kit

GLOBAL P5: CARD LOAD		▶Source					
Load Combi/Prog	▶Load 1 Drum Kit	Load All Sequence	Load 1 Song				
Load 1 Combi	Load 1 Pattern	Load 1 Prog					
C:Kit1		→		A:Kit1			
				[LOAD]			
A	B	C	D	E	F	G	H

[A]	Card Drum Kit	C:Kit1 — D:Kit2	Specify the Drum Kit to be loaded from card
[D]	Int Drum Kit	A:Kit1 — B:Kit2	Specify the internal memory into which the Drum Kit will be loaded
[G]		[LOAD]	Execute loading

▼This operation loads a Drum Kit from a card.

(1) Specify the Drum Kit ([A]) ON the card and the loading destination Drum Kit ([D]).

(2) Press [LOAD] ([G]), and the display will ask whether you are sure you want to load. To load the data press [YES] ([E]). To quit without loading press [NO] ([G]).

P5-6 Card Load 1 Song

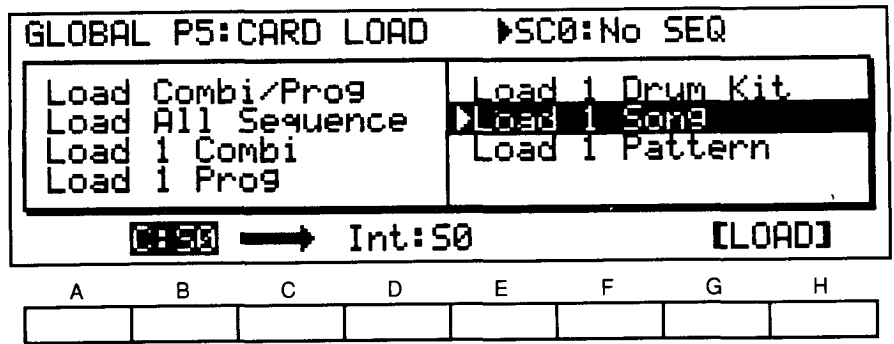

[A]	Card Song	C:S0 — D:S9	Specify the Song to be loaded from the card
[D]	Internal Song	Int:S0 — Int:S9	Specify the internal memory into which the Song will be loaded
[G]		[LOAD]	Execute loading

▼This operation loads a Song from a card.
 (1) Specify the Song ([A]) on the card and the loading destination of the Song ([D]).

(2) Press [LOAD] ([G]), and the display will ask whether you are sure you want to load. To load the data press [YES]([E]). To quit without loading press [NO] ([G]).
 * After loading, the Program bank for each Track will be changed, from C to A, and from D to B.

P5-7 Card Load 1 Pattern

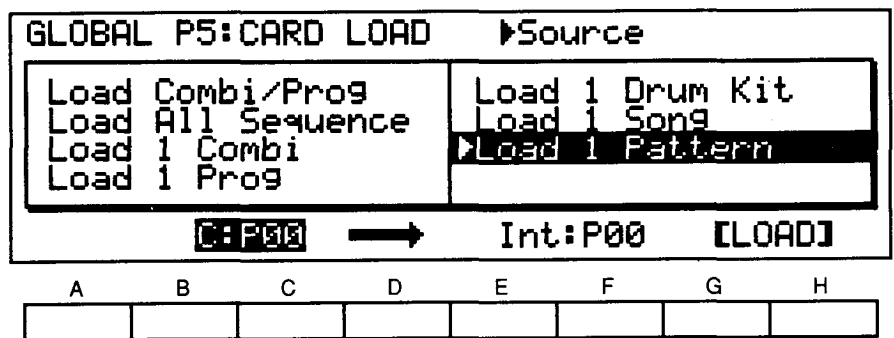

[A]	Card Pattern	C:P00 — D:P99	Specify the Pattern to be loaded from the card
[D]	Internal	Pattern Int:P00 — Int:P99	Specify the internal memory into which the Pattern will be loaded [LOAD] Execute loading
[G]		[LOAD]	Execute loading

▼This operation loads a Pattern from a card.
 (1) Specify the Pattern ([A]) on the card and the loading destination of the Pattern ([D]).

(2) Press [LOAD] ([G]), and the display will ask whether you are sure you want to load. To load the data press [YES]([E]). To quit without loading press [NO] ([G]).

Page-6 Card Save

P6-1 Card Save All Combi / Prog / Drums / Glob

GLOBAL P6: CARD SAVE		▶Source Bank	
▶Save Combi/Prog			
Save All Sequence			
Bank-A+B		→	Bank-C+D
		[SAVE]	
A	B	C	D
E	F	G	H

[A]	Source Bank	A + B, A, B	Specify the bank from which the data will be saved
[D]	Dest Card Bank	C + D, C, D	Specify the bank into which the data will be saved
[G]		[SAVE]	Execute saving

▼This operation saves (writes) internal memory data (100 Combinations, 100 Programs, 2 Drum Kits, Global parameters) to a RAM card.

• The protect switch located on the upper part of the card must be set to "OFF".

- (1) Specify the Bank ([A]) from which the data will be saved.
- (2) Specify the Bank ([D]) into which the data will be saved.

- (3) Press [SAVE] ([G]), and the display will ask whether you are sure you want to save. To save the data press [YES] ([E]). To quit without saving press [NO] ([G]). Data for two banks is saved at one time when you select A + B as the loading bank and C + D as the bank to which the data will be saved. Data from bank A will be saved in bank C, and data from bank B will be saved in bank D.

• When you execute saving to a card, the card will automatically be formatted. Set the protect switch "ON" for cards containing important data that you do not want to erase accidentally.

☆ After saving, the Program banks within a Combination will be changed from A and B (internal memory) to C and D (card). When saving from Bank A to C or from Bank B to D, the Program bank within the Combination will also change from A to C or from B to D. When saving is done from B to C or from A to D, the Program bank will likewise change from B to C or from A to D.

P6-2 Card Save All Sequence Data

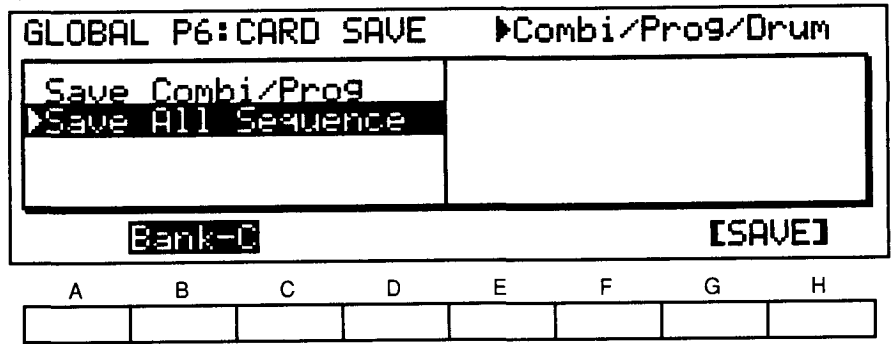

[A]	Card Bank	C, D	Specify the bank into which the data will be saved
[G]		[SAVE]	Execute saving

▼This operation saves (writes) internal sequence data (10 Songs, 100 patterns) to a RAM card.

- The protect switch located on the upper part of the card must be set to "OFF".
- (1) Specify the Bank ([A]) into which the data will be saved.
- (2) Press [SAVE] ([G]), and the display will ask whether you are sure you want to save. To save the data press [YES] ([E]). To quit without saving press [NO] ([G]).

* It is not possible to save All Data or Sequence data on a RAM card unless the sequence data memory is 86% or more free. If sequence data memory is less than 86% free, save the data to disk. (This is because a RAM card has a capacity of 7,000 steps of sequence data, but the 01/WFD sequence memory has a capacity of 48,000 steps.)

☆ Sequence data which has been saved to a card can be played but it cannot be edited or recorded. Load sequence data from the card (P5-2) before carrying out these operations.

* After saving, the Program bank for each Track will be changed, from A to C, and from B to D.

Page-7 Preload

P7-1 Load All Combi/Prog/Drums/Global

GLOBAL P7:PRELOAD				▶ROM			
▶Load Combi/Prog				Load Demo Sequence			
Load 1 Combi							
Load 1 Prog							
Load 1 Drum Kit							
Bank-A+B → Bank-A+B				[LOAD]			
A	B	C	D	E	F	G	H

[A]	Source Bank	A+B, A, B	Specify the ROM to be loaded
[D]	Destination Bank	A+B, A, B	Specify the bank to which data will be loaded
[G]		[LOAD]	Execute loading

▼ This operation loads 100 Combinations, 100 Programs, 2 Drum Kits, and the Global parameters from a ROM card into internal memory.

(1) Specify the Bank ([A]) from which the data will be loaded.

(2) Specify the Bank ([D]) to which the data will be loaded.

- When "A+B" has been selected as the Bank to be loaded or as the load destination, data from banks will be loaded in one operation.

☆ When data is loaded to Bank A, the Global preload settings will be changed according to the values in the new data. The LCD contrast and memory protect status will remain unchanged.

(3) Press [LOAD] ([G]), and the display will ask whether you are sure you want to load. To load the data press [YES]([E]). To quit without loading press [NO] ([G]).

P7-2 Load 1 Combination

GLOBAL P7:PRELOAD				▶A00:DawnOfTime			
▶Load Combi/Prog				Load Demo Sequence			
▶Load 1 Combi							
Load 1 Prog							
Load 1 Drum Kit							
A00 → A00				[LOAD]			
A	B	C	D	E	F	G	H

[A]	ROM Combination	A00 — B99	Specify the ROM combination to be loaded
[D]	Internal Combination	A00 — B99	Specify the internal memory combination to which data will be loaded
[G]		[LOAD]	Execute loading

This operation loads a Combination from a card to a number specified in the internal memory.

You will need to use the 7-3 Load 1 Program operation to load each Program used by the ROM Combination.

(1) Specify the ROM Combination ([A]) and the loading destination Combination ([D]).

(2) Press [LOAD] ([G]), and the display will ask whether you are sure you want to load. To load the data press [YES]([E]). To quit without loading press [NO] ([G]).

P7-3 Load 1 Program

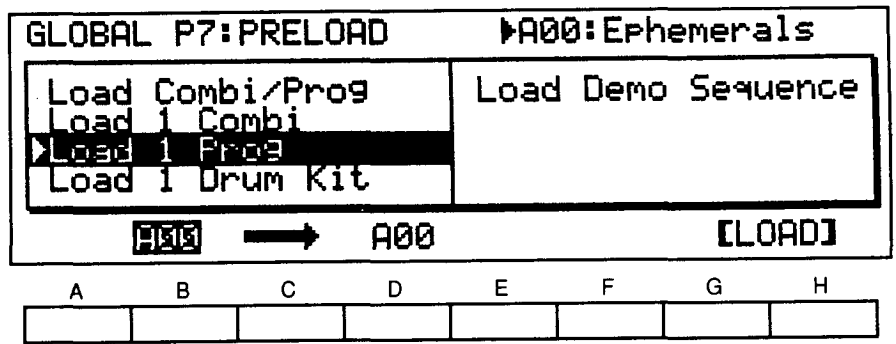

[A]	ROM Program	A00 — B99	Specify the ROM program to be loaded
[D]	Internal Program	A00 — B99	Specify the internal memory program to which data will be loaded
[G]		[LOAD]	Execute loading

▼This operation loads a Program from a card to a number specified in the internal memory.

- (1) Specify the ROM Program ([A]) and the loading destination Program ([D]).
- (2) Press [LOAD] ([G]), and the display will ask whether you are sure you want to load. To load the data press [YES]([E]). To quit without loading press [NO] ([G]).

P7-4 Load 1 Drum Kit

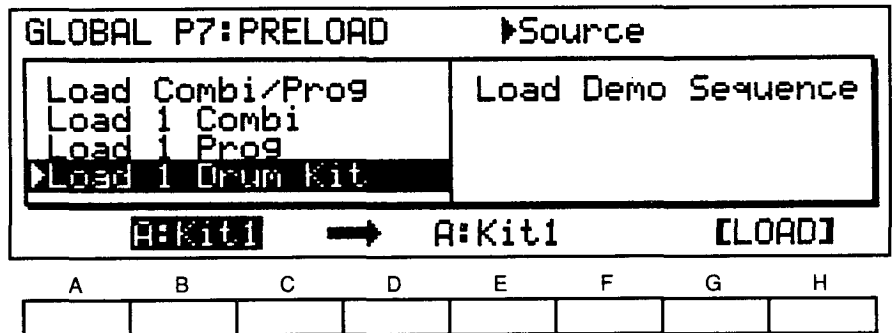

[A]	ROM Drum Kit	A:Kit1 — B:Kit2	Specify the ROM Drum Kit to be loaded
[D]	Int Drum Kit	A:Kit1 — B:Kit 2	Specify the internal memory Drum Kit to which data will be loaded
[G]		[LOAD]	Execute loading

▼This operation loads a Drum Kit from a card to a number specified in the internal memory.

- (1) Specify the ROM Drum Kit ([A]) and the loading destination Drum Kit ([D]).
- (2) Press [LOAD] ([G]), and the display will ask whether you are sure you want to load. To load the data press [YES]([E]). To quit without loading press [NO] ([G]).

P7-5 Load Demo Sequence (01/W only)

GLOBAL P7:PRELOAD							
Load Combi/Prog	▶Load Demo Sequence						
Load 1 Combi							
Load 1 Prog							
Load 1 Drum Kit							
							[LOAD]
A	B	C	D	E	F	G	H

[G]		[LOAD]	Execute loading
-----	--	--------	-----------------

▼ Demo sequence data is pre-loaded when the unit is shipped from the factory.

Use this function to re-load the original demo sequence data. Note: this function will replace any data in SEQ mode with the demo sequence data.

- When [Load] [G] is pressed, the display will ask "Are You Sure?". Press YES [E] to load the data, or No [G] to interrupt the loading sequence.

* Since the programs used for the demo performance are also pre-loaded (before the unit is shipped from the factory), they should be loaded at this time, using P7-1.

MIDI Data Dump

The 01/WFD•01/W can transmit parameter and sequence data from its internal memory to another 01/WFD•01/W connected via MIDI.

- When this page is selected, MIDI data dumps can be transmitted and received regardless of the MIDI Filtering Exclusive setting in Global mode.
- To receive data, be sure that memory protect is turned "OFF", and that the global MIDI channels of the transmit-

ting and receiving devices match. No other operations are necessary.

- By using a MIDI device that is able to save exclusive data, you can store voice data and sequence data in an external device.
- For details of the exclusive message data format, refer to the end of this manual.

Data type	Length of message	Time required for transmission
Programs (200)	approx. 39 Kbytes	approx. 13 seconds
Combinations (200)	approx. 29 Kbytes	approx. 10 seconds
Drum Kit data (4)	approx. 2 Kbytes	approx. 1 second
Global data	31 bytes	less than 1 second
Sequence data (01/WFD)	4 K — 223 Kbytes	1 — 72 seconds
Sequence data (01/W)	4 K — 36 Kbytes	1 — 12 seconds
Combination / Program / Drum Kit / Global / Sequence (01/WFD)	74 Kbytes — 294 Kbytes	24 — 94 seconds
Combination/Program/Drum Kit/ Global/Sequence (01/W)	74 Kbytes — 107 Kbytes	24 — 34 seconds

Page-8 Data Dump**P8-1 Dump Program**

GLOBAL P8:DATA DUMP							
▶DUMP Program				DUMP Sequence			
DUMP Combination				DUMP All Data			
DUMP Drum Kit							
DUMP Global							
[DUMP]							
A	B	C	D	E	F	G	H

G		[DUMP]	Execute the Dump operation
---	--	--------	----------------------------

▼This operation transmits (dumps) the data for 200 internal Programs to another 01/WFD or 01/W connected via MIDI. Press [DUMP] to execute the data dump.

P8-2 Dump Combination

GLOBAL P8:DATA DUMP							
DUMP Program				DUMP Sequence			
▶DUMP Combination				DUMP All Data			
DUMP Drum Kit							
DUMP Global							
[DUMP]							
A	B	C	D	E	F	G	H

G		[DUMP]	Execute the Dump operation
---	--	--------	----------------------------

▼This operation transmits (dumps) the data for 200 internal Combinations to another 01/WFD or 01/W connected via MIDI. Press [DUMP] to execute the data dump.

P8-3 Dump Drum Kit

GLOBAL P8:DATA DUMP							
DUMP Program				DUMP Sequence			
DUMP Combination				DUMP All Data			
▶DUMP Drum Kit							
DUMP Global							
[DUMP]							
A	B	C	D	E	F	G	H

[G]		[DUMP]	Execute the Dump operation
-----	--	--------	----------------------------

▼This operation transmits (dumps) the data for the 4 Drum Kits in internal memory (created in Global mode P1 , P2) to another 01/WFD or 01/W connected via MIDI. Press [DUMP] to execute the data dump.

P8-4 Dump Global

GLOBAL P8:DATA DUMP							
DUMP Program				DUMP Sequence			
DUMP Combination				DUMP All Data			
DUMP Drum Kit							
▶DUMP Global							
[DUMP]							
A	B	C	D	E	F	G	H

[G]		[DUMP]	Execute the Dump operation
-----	--	--------	----------------------------

▼This operation transmits (dumps) all Global parameters except for MIDI settings to another 01/WFD or 01/W connected via MIDI. Press [DUMP] to execute the data dump.

P8-5 Dump Sequence

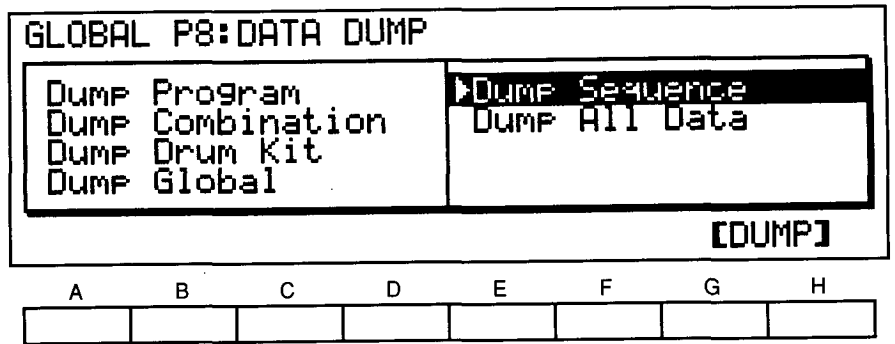

G		[DUMP]	Execute the Dump operation
---	--	--------	----------------------------

▼ This operation transmits (dumps) all sequence data to another 01/WFD•01/W connected via MIDI. Press [DUMP] to execute the data dump.

☆ When dumping sequence data from an 01/WFD to an 01/W, check to be sure that 86% or more of the 01/WFD's sequence data memory is free. (48,000 steps are available on the 01/WFD, and 7,000 steps for the 01/W.)

P8-6 Dump All Data

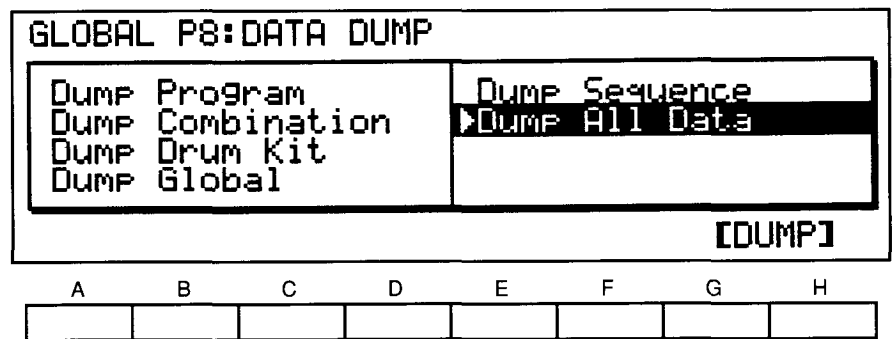

G		[DUMP]	Execute the Dump operation
---	--	--------	----------------------------

▼ This operation transmits (dumps) all Program parameters, Combination parameters, Drum Kit data, Global parameters, and Sequence data from internal memory to another 01/WFD•01/W connected via MIDI. Press [DUMP] to execute the data dump.

☆ When dumping all data from an 01/WFD to an 01/W, check to be sure that 86% or more of the 01/WFD's sequence data memory is free. (48,000 steps are available on the 01/WFD, and 7,000 steps for the 01/W.)

8. DISK MODE (01/WFD only)

In this mode, data can be loaded from a disk (copied into internal memory), or saved to a disk (copied from internal memory).

* On the 01/WFD, the contents of sequencer memory will be lost when the power is turned off. Be sure to save important data to disk before turning the power off.

• Only 3.5 inch disks marked “Double sided double density, double track” can be used. These disks are usually labeled “MF2DD”, “MFD-2DD”, etc.

* Two types of floppy disk formats may be used with the 01/WFD. One type of format is used for the 01/W series and the other type is used for Standard MIDI Files.

FUNCTIONS IN DISK MODE

• Use the numeric keys (0 — 9) and the PAGE+ and PAGE- keys to select the page.

* The disk format used for P4 differs from that used for P0-P3.

Page	Function	
P0	DISK LOAD 1	Load disk data into internal memory (copy all data)
P1	DISK LOAD 2	Load disk data into internal memory (copy individual Combinations, etc.)
P2	DISK SAVE	Save internal memory data to disk
P3	MIDI DATA FILE	Transmit MIDI bulk data (load, save)
P4	STANDARD MIDI FILE	Load/save/format Standard MIDI File data

ABOUT FILES

Two types of floppy disk formats may be used with the 01/WFD. One type of format is used for the 01/W series and the other type is used for Standard MIDI Files.

* Each disk file contains data from the two internal banks.

• 01/W series format

The 01/WFD uses two files on each disk; file A and file B. Each file contains all internal data and all data received by the MIDI data file function.

one file

200 Combinations
 200 Programs
 4 Drum Kits
 1 set of Global data
 Sequence data (10 songs, 100 patterns)
 MIDI data (64 Kbytes)

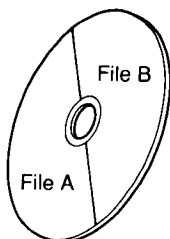

• Standard MIDI Format

Multiple files may be stored for use on the disk. For files that contain sequence data, each file corresponds to a single song.

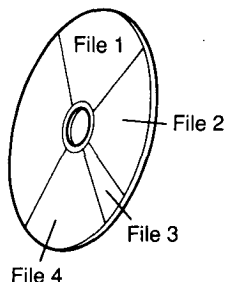

One file

Sequence data for 1 song
(Playback data only)

Standard MIDI File

This standard makes it possible to use sequence data from a floppy disk regardless of the source equipment or manufacturer. Files of sequence data made on equipment that conforms to this standard can be loaded and played back on the 01/WFD. In addition, sequence data created on the 01/WFD can be saved to disk as a Standard MIDI File, making it possible to load and play back this data on other equipment as well.

There are two types of formats used by the 01/WFD for saving sequence data to disk. The 01/W series format makes it possible to save the sequence settings and playback data created on the 01/WFD. This data (up to 48,000 steps) can then be loaded to and played back on the 01/WFD, 01/W_{pro}, and 01/W_{proX}.

Only playback data can be saved as a Standard MIDI File. Such data cannot be loaded to a 01/WFD that doesn't conform to the Standard MIDI File format (old system ROM), but it can be loaded to and played back on equipment made by other manufacturers that conforms to this MIDI standard.

Select the format that is appropriate for saving your data when you format each floppy disk.

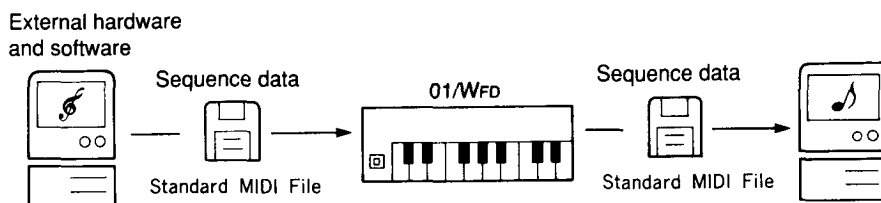

When sequence data is transmitted as a Standard MIDI File using a 01/WFD, you should check in advance to make sure that the 01/WFD can use the Standard MIDI file.

The Standard MIDI File disk compatible with the 01/WFD is a 720K DOS-formatted disk.

DISK

Loading from disk

This operation loads data from disk into internal memory.

- When you load data, the data previously in internal memory will be overwritten and lost.

The following types of data can be loaded.

All data (P0-1)	all Combinations, Programs, and Global parameters (P0-2)	1 Combination (P1-1) 1 Program (P1-2) 1 Drum Kit (P1-5)
	All sequence data (P0-3)	1 Song (P1-3) 1 Pattern (P1-4)
MIDI Data File (P3-1)		

- Never remove the disk while the data is being loaded (the display shows "Now Loading").
- When the data has been correctly loaded, the display will show "Completed". If an error message appears, re-insert the disk in the disk drive, and try the load operation once again. (Refer to page 211 "Error messages" for an explanation of each error message.)
- Loading is not possible if Global mode P4-5 Memory Protect is turned On.

Page-0 Disk Load

P0-1 Disk Load All Data

DISK P0:LOAD-1 ▶Source File

<div style="border: 1px solid black; padding: 2px;"> <p>▶Load All Data</p> <p>Load Combi/Prog</p> <p>Load All Sequence</p> </div>	
File-E	[LOAD]

A
B
C
D
E
F
G
H

--	--	--	--	--	--	--	--

[A]	File	A, B	Specify the disk file to be loaded
[G]		[LOAD]	Execute loading

▼This operation loads all data (except MIDI data) from the specified disk file into internal memory (Banks A and B, sequence memory). The LCD contrast and memory protect status will remain unchanged.

(1) Insert the disk into the disk drive.

(2) Specify the disk file to be loaded ([A], file A or B).

(3) Press [LOAD] ([G]). Then, if you are sure you want to execute loading, press [YES] ([E]). To quit without loading, press [NO] ([G]).

P0-2 Disk Load All Combi/Prog

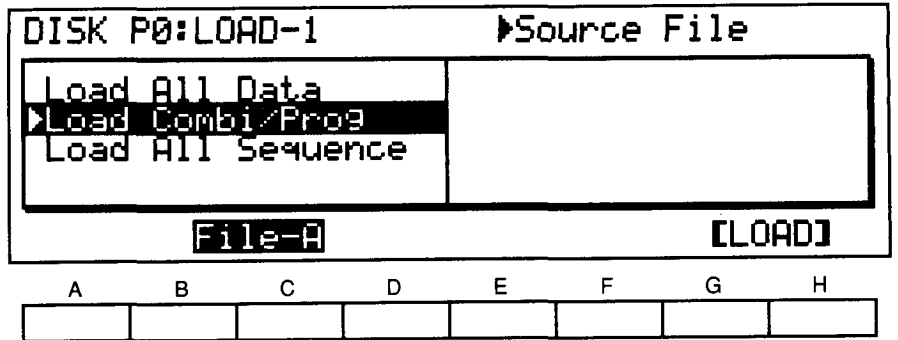

▼This operation loads all Combinations, Programs, Drum Kits, and Global parameters from the specified disk file into internal memory (Banks A and B). The LCD contrast and memory protect status will remain unchanged.

• The procedure is the same as for P0-1 Load All Data.

P0-3 Disk Load All Sequence

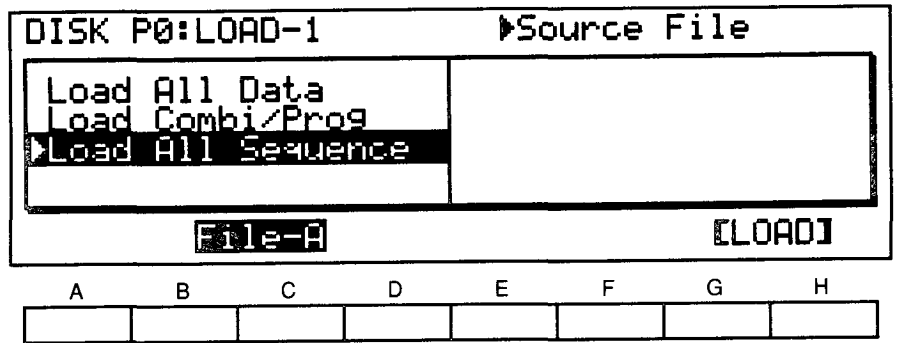

▼This operation loads all sequence data from the specified disk file into internal sequence memory.

• The procedure is the same as for P0-1 Load All Data.

Page-1 Disk Load-2

P1-1 Disk Load 1 Combination

DISK P1:LOAD-2				▶Source File			
Load 1 Combi				Load 1 Drum Kit			
Load 1 Prog							
Load 1 Song							
Load 1 Pattern							
File-A --- → A00				[LOAD]			
A	B	C	D	E	F	G	H

[A]	File	A, B	Specify the disk file from which to load a Combination
[C]	Disk Combination	A00—A99, B00—B99	Specify the Combination from the file being loaded
[E]	Internal Combination	A00—A99, B00—B99	Specify the internal memory Combination into which the data will be loaded
[G]		[LOAD]	Execute loading

▼This operation loads one Combination from a disk file.

- Use the P1-2 Load 1 Program operation to load the Programs used by that Combination into the same Program numbers.

- (1) Insert the disk into the disk drive.
- (2) Specify the disk file containing the Combination to be loaded ([A]), the Combination number ([C]), and the internal memory Combination number ([E]) into which the Combination is to be loaded.

- When you press [C], no other operations will be possible for approximately 0.4 — 1.6 seconds while the Combination name area of the disk is being searched.
- When searching ends, the Combination names will be displayed in the upper right of the screen.

DISK P1:LOAD-2				▶A-A00:Organ 1			
Load 1 Combi				Load 1 Drum Kit			
Load 1 Prog							
Load 1 Song							
Load 1 Pattern							
File-A A00 → A00				[LOAD]			
A	B	C	D	E	F	G	H

- (3) Press [LOAD] ([G]). Then, if you are sure you want to execute loading, press [YES] ([E]). To quit without loading, press [NO] ([G]).

P1-2 Disk Load 1 Program

DISK P1:LOAD-2				▶Source File			
Load 1 Combi				Load 1 Drum Kit			
▶Load 1 Prog							
Load 1 Song							
Load 1 Pattern							
File-A --- → A00				[LOAD]			
A	B	C	D	E	F	G	H

[A]	File	A, B	Specify the disk file from which to load a Program
[C]	Disk Program	A00 — A99, B00 — B99	Specify the Program from the file being loaded
[E]	Internal Program	A00 — A99, B00 — B99	Specify the internal memory Program into which the data will be loaded
[G]		[LOAD]	Execute loading

This operation loads one Program from a disk file.

- (1) Insert the disk into the disk drive.
- (2) Specify the disk file containing the Program to be loaded ([A]), the Program number ([C]), and the internal memory Program number ([E]) into which the Program is to be loaded.

- When you press [C], no other operations will be possible for approximately 0.4 — 1.6 seconds while the Program name area of the disk is being searched.
 - When searching ends, the Program names will be displayed in the upper right of the screen.
- (3) Press [LOAD] ([G]). Then, if you are sure you want to execute loading, press [YES] ([E]). To quit without loading, press [NO] ([G]).

P1-3 Disk Load 1 Song

DISK P1:LOAD-2				▶Source File			
Load 1 Combi				Load 1 Drum Kit			
Load 1 Prog							
▶Load 1 Song							
Load 1 Pattern							
File-A		--	→	Int:S0		[LOAD]	
A	B	C	D	E	F	G	H

[A]	File	A, B	Specify the disk file from which to load a Song
[C]	Disk Song	S0 — S9	Specify the Song from the file being loaded
[E]	Internal Song	S0 — S9	Specify the internal memory Song into which the data will be loaded
[G]		[LOAD]	Execute loading

▼This operation loads one Song from a disk file.

- When loading a Song that uses patterns, load the necessary patterns first.

- (1) Insert the disk into the disk drive.
- (2) Specify the disk file containing the Song to be loaded ([A]), the Song number ([C]), and the internal memory Song number ([E]) into which the Song is to be loaded.

- When you press [C], no other operations will be possible for approximately 0.4 — 1.6 seconds while the Song name area of the disk is being searched.

- When searching ends, the song names will be displayed in the upper right of the screen.

- (3) Press [LOAD] ([G]). Then, if you are sure you want to execute loading, press [YES] ([E]). To quit without loading, press [NO] ([G]).

P1-4 Disk Load 1 Pattern

DISK P1:LOAD-2				▶Source File			
Load 1 Combi				Load 1 Drum Kit			
Load 1 Prog							
Load 1 Song							
▶Load 1 Pattern							
File-A		P00	→	Int:P00		[LOAD]	
A	B	C	D	E	F	G	H

[A]	File	A, B	Specify the disk file from which to load a Pattern
[C]	Disk Pattern	P00 — P99	Specify the Pattern from the file being loaded
[E]	Internal Pattern	P00 — P99	Specify the internal memory Pattern into which the data will be loaded
[G]		[LOAD]	Execute loading

This operation loads one Pattern from a disk file into internal memory.

- (1) Insert the disk into the disk drive.
- (2) Specify the disk file containing the Pattern to be loaded ([A]), the Pattern number ([C]), and the internal memory Pattern number ([E]) into which the Pattern is to be loaded.

- (3) Press [LOAD] ([G]). Then, if you are sure you want to execute loading, press [YES] ([E]). To quit without loading, press [NO] ([G]).

P1-5 Disk Load 1 Drum Kit

DISK P1:LOAD-2		▶Source File					
Load 1 Combi		▶Load 1 Drum Kit					
Load 1 Prog							
Load 1 Song							
Load 1 Pattern							
File-A	A:Kit1	→ A:Kit1 [LOAD]					
A	B	C	D	E	F	G	H

[A]	File	A, B	Specify the disk file from which to load a Drum Kit
[C]	Disk Drum Kit	A:Kit1 — B:Kit2	Specify the Drum Kit from the file being loaded
[E]	Internal Drum Kit	A:Kit1 — B:Kit2	Specify the internal memory Drum Kit into which the data will be loaded
[G]		[LOAD]	Execute loading

▼This operation loads one Drum Kit from a disk file.

- (1) Insert the disk into the disk drive.
- (2) Specify the disk file containing the Drum Kit to be loaded ([A]), the Drum Kit number ([C]), and the internal memory Drum Kit number ([E]) into which the Drum Kit is to be loaded.

- (3) Press [LOAD] ([G]). Then, if you are sure you want to execute loading, press [YES] ([E]). To quit without loading, press [NO] ([G]).

Saving to disk

Use these operations to save data from internal memory to disk. When data is saved to a disk file which already exists, the old data of that disk file will be lost. You can use the disk protect slider to keep important disk data from being accidentally overwritten.

- The following types of data can be saved to disk.

All data (P2-1)	All Combinations / Programs / Drum Kits / Global parameters (P2-2)
	All Sequence data (P2-3)
MIDI data file	(P3-2)

- It is not possible to rewrite an individual Combination, Program, Song, Pattern, or Drum Kit inside a file. Load the file you want to edit (but remember to first save the current contents of internal memory as a different file), and edit it in internal memory.

- A newly purchased disk must be “formatted” before it can be used to store data. 2DD disks used by another device or for Standard MIDI Files must also be formatted before they can be used to store 01/WFD data. For details, see P2-4 Format Disk.
- While data is being saved to disk and the display shows “Now Saving”, do not remove the disk.
- When the data has been correctly saved, the display will show “Completed”. If an error message appears, re-insert the disk in the disk drive, and try the save operation once again. (Refer to page 211 “Error messages” for an explanation of each error message.)
- Be sure to release the disk protect slider before trying to save data or format a disk.

Page-2 Disk Save All

P2-1 Disk Save All Data

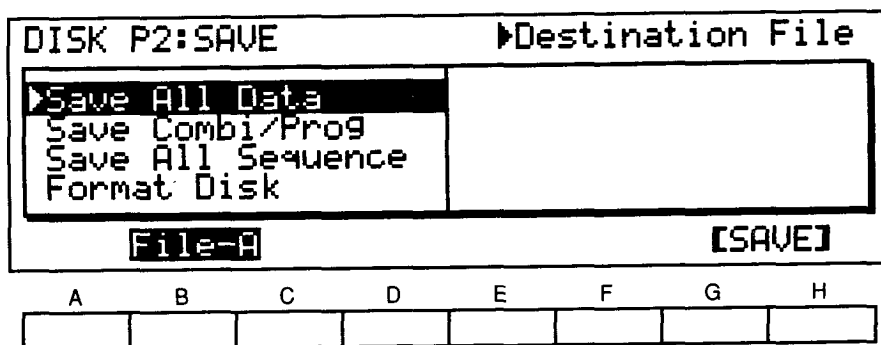

[A]	File	A, B	Specify the disk file into which the data will be saved
[G]		[SAVE]	Execute saving

▼This operation saves all internal memory (Bank A + B, sequence memory) data (except MIDI data) to disk.

(1) Insert the disk into the disk drive.

- Make sure that the write protect slider is in the Write Permit position.

- Specify the disk file into which the data will be saved ([A], file A or B).
- Press [SAVE] ([G]). Then, if you are sure you want to execute saving, press [YES] ([E]). To quit without saving, press [NO] ([G]).

P2-2 Disk Save All Combi / Prog / Drums / Global

DISK P2:SAVE		Destination File					
Save All Data							
▶ Save Combi/Prog							
Save All Sequence							
Format Disk							
File-A		[SAVE]					
A	B	C	D	E	F	G	H

▼ This operation saves all Combinations, Programs, Drum Kits, and Global parameters from internal memory (Banks A and B) to disk.

• The procedure is the same as explained in P2-1 Save All Data.

P2-3 Disk Save All Sequence

DISK P2:SAVE		Destination File					
Save All Data							
Save Combi/Prog							
▶ Save All Sequence							
Format Disk							
File-A		[SAVE]					
A	B	C	D	E	F	G	H

▼ This operation saves all Sequence data from internal sequence memory to disk.

• The procedure is the same as explained in P2-1 Save All Data.

Formatting a disk

P2-4 Format Disk

DISK P2:SAVE							
Save All Data							
Save Combi/Prog							
Save All Sequence							
▶Format Disk							
							[FORMAT]
A	B	C	D	E	F	G	H

[G]		[FORMAT]	Execute formatting (initialization)
-----	--	----------	-------------------------------------

▼This operation formats a floppy disk (3.5' 2DD type) for use by the 01/WFD.

- A newly purchased floppy disk must be formatted before it can be used to store data. 2DD floppy disks used by other devices or for Standard MIDI Files must also be formatted before they can be used to store 01/W series data. When a disk is formatted, all its data is erased. Be careful not to format a disk containing important data, and use the disk write protect slider to prevent accidental erasure.

(1) Insert the disk into the disk drive.

(2) Press [FORMAT] ([G]). Then, if you are sure you want to format the disk, press [YES] ([E]). To quit without formatting, press [NO] ([G]).

- Make sure that the disk write protect tab is in the WRITE PERMIT position.
- Formatting takes approximately 2 minutes.
- Never attempt to remove the disk while formatting is taking place (while the display shows "Now Formatting").
- When formatting is completed, the display will show "Completed". If an error message appears, re-insert the disk into the disk drive and try the operation once again. If an error appears again, try formatting a different disk. (For an explanation of each error message, see "Error messages" page 211.)
- * The formatting of disks for Standard MIDI Files is described under P4-4.

MIDI data file

The 01/WFD can receive MIDI Exclusive data (sound data etc. specific to each device) from external devices and save this data to disk.

- Each file can store up to 64 Kbytes of MIDI data.
- Since each device handles MIDI exclusive messages in different ways, it may not be possible for the 01/WFD to save data from a certain device even if that device is able to use exclusive messages.

* In order to save or load MIDI data files, the sequence data memory must be at least 35% free.

* When this page has been selected, MIDI data can be transferred regardless of the MIDI Filtering Exclusive setting selected in the Global mode.

Page-3 Data file

P3-1 Disk Load MIDI Data

DISK P3:DATA FILE				▶Source File			
▶Load MIDI Data							
Save MIDI Data							
File-A				[LOAD]			
A	B	C	D	E	F	G	H

[A]	File	A, B	Specify the disk file to be loaded
[G]		[LOAD]	Execute loading

▼This operation loads exclusive data (unique data for each device) that was received from an external MIDI device using the P3-2 Save MIDI Data function, and transmits this data from MIDI OUT.

- (1) Insert the disk into the disk drive.
- (2) Specify the file ([A] , file A or B) to be loaded.

(3) Press [LOAD] ([G]). Then, if you are sure you want to load the data, press [YES] ([E]). To quit without loading, press [NO] ([G]).

- Never attempt to remove the disk while the "Now Loading" message appears in the display.

P3-2 Disk Save MIDI Data

DISK P3:DATA FILE								▶File	
Load MIDI Data									
Save MIDI Data								Awaiting MIDI data	
File-A								[SAVE]	
A	B	C	D	E	F	G	H		

[A]	File	A, B	Specify the disk file into which the data will be saved
[G]		[SAVE]	Execute saving

▼ This operation receives a MIDI system exclusive message from an external MIDI device, and saves the data to disk. All data received from when you selected this function until you press [SAVE] ([G]) will be saved.

* To save a MIDI Data File, the sequence data memory must be at least 35% free.

- (1) Insert the disk to which you will save the data into the disk drive.
- (2) Specify the file ([A], file A or B) into which the data will be saved.
- (3) Operate the MIDI device connected to the 01/WFD MIDI IN to make it transmit the system exclusive data you want to store. Different devices will call this function by various names, such as "Data Dump", "Transmit Exclusive Data", etc. Consult the manual for your device.

- The display will indicate the number of bytes in the received message.
- Exclusive messages from more than one device can be received, up to a total of 64 Kbytes of data (approximately 21 seconds total). (If you will be saving data from two or more devices of the same type, you will need to distinguish the data in some way, for instance by transmitting the data on different MIDI channels. Korg devices allow you to specify the transmission channel of exclusive data.)
- If the received data exceeds 64 Kbytes, an error message will appear, and the previously received data will be invalid.
- (4) When you are finished receiving, press [SAVE] ([G]). Then, if you are sure you want to save the data to disk, press [YES] ([E]). To quit without saving, press [NO] ([G]). The data will not be saved to disk until you perform this step.
- Never attempt to remove the disk while the "Now Saving" message appears in the display.

Standard MIDI file

Page-4 Standard MIDI file

The Standard MIDI File functions on this page make it possible to load sequence data from a floppy disk regardless of the source equipment or manufacturer (insomuch as that equipment conforms to this MIDI standard).

P4-1 Load Song Data

DISK P4:STD MIDI FILE ▶File							
▶Load Std MIDI File							
Set Date for Save							
Save Std MIDI File							
Format Disk							
ENTEROK MID Jun 24 1993 Song0 [LOAD]							
A	B	C	D	E	F	G	H

[A]			Select file to be loaded from disk
[D] Song		0 ~ 9	Select load destination of song
[G]		[LOAD]	Execute loading

▼This operation loads the sequence data saved to a double-density, 720K DOS-formatted disk in the Standard MIDI File format.

- (1) Insert the disk into the disk drive.
- (2) Press [A] to select the file to be loaded.
- (3) Press [D] to select the load destination of the Song.
- (4) Press [LOAD] ([G]). If you are sure you want to load the data, press YES ([E]). To quit without loading, press NO ([G]).

- Do not remove the disk while the "Now Loading" message is displayed.
- * When saving sequence data created on the 01/WFD as a Standard MIDI File, the Memory Full message may appear. This is because all of the Patterns are opened at the time the data is saved.
- ☆ You need to set track settings individually after the song name and performance data are loaded from the disk.

P4-2 Date For Save

DISK P4:STD MIDI FILE ▶Month	
Load Std MIDI File	
▶Set Date for Save	
Save Std MIDI File	
Format Disk	
Sep 08 1991	

A	B	C	D	E	F	G	H

B	Month	Jan ~ Dec	Set the month
C	Day	01 ~ 31	Set the date
D	Year	1980 ~ 2079	Set the year

▼This operation is used to add the date to files that are being saved.

When the file is loaded using P4-1, the date added in this operation will be displayed at B. This date will be displayed when viewing a disk directory on a personal computer.

P4-3 Save Song Data

DISK P4:STD MIDI FILE ▶Song							
Load Std MIDI File							
Set Date for Save							
Save Std MIDI File							
Format Disk							
[A] ▶ NEW_SONG Fmt0 [◀] [▶] [SAVE]							
A	B	C	D	E	F	G	H

[A] S	Song	0 ~ 9	Select song to be saved
[E]		[◀]	Move the file rename cursor to the left
[F]		[▶]	Move the file rename cursor to the right
[D] Fmt	File Format	0, 1	Select the file format used when saving a file
[G]		[SAVE]	Execute saving

▼This operation saves a Song in memory to disk in the Standard MIDI File format.

- The Song name and playback data are saved.

- (1) Set the write protect slider on the floppy disk so data can be saved to the disk.
- (2) Press [A] to select the Song to be saved. Press [B] to display the song names. The first 8 characters of names (up to 10 characters long) will be displayed. The underline character “_” is displayed at the position where an unavailable character has been entered. If the first 8 characters in a Song name match the name used for another file, the “_” symbol will replace the Song name.

Check to be sure the file name you want to assign to the data does not already exist on the disk.

- (3) If necessary, use the ◀[E] and ▶[F] keys with the Value slider and the△and▽keys to change a file name being displayed. Use capital letters, numerals and symbols (some of which can be used for song names but not for file names) in combination to form the name, which can be up to 8 characters long.

* At this point, be sure to use the new song name after pressing [A] to select a song.

- (4) Press [D] to select the format used when saving the file. Select either 0 or 1 for the format of each file.

Format 0: All of the data from tracks 1-16 will be saved on a single track.

Format 1: The data for each track is saved separately. Data is saved separately to each of the tracks, in the same manner as when the data is created.

Format 1 will be selected under most circumstances.

However, if there is a problem when loading the data to another device (e.g. the device will not respond to Format 1 or the number of tracks is inappropriate), use Format 0 to save the data.

- (5) Press [SAVE] ([G]). If you want to save the data, press [YES] ([E]). To quit without saving, press [NO] ([G]). If the file name already exists on the disk, the File Already Exists, Overwrite? message will appear. Select [YES] or [NO] to proceed.

- Do not remove the disk while the “Now Saving” message is displayed.
- * The file name extension .MID is used. An example of this would be KORG.MID.
- * In sections which contain Patterns, the Patterns are opened before they are saved. Because of this, a large portion of the disk’s memory is used when saving a Song that uses several Patterns. This may make it difficult to re-load this data to the 01/WFD.

P4-4 Format Disk

DISK P4:STD MIDI FILE							
Load Std MIDI File							
Set Date for Save							
Save Std MIDI File							
▶Format Disk							
							[FORMAT]
A	B	C	D	E	F	G	H

[G]		[FORMAT]	Execute formatting (initialization)
-----	--	----------	-------------------------------------

▼This operation formats a floppy disk (3.5" 2DD) for the use of Standard MIDI Files.

- A newly purchased floppy disk must be formatted before it can be used to store data. 2DD floppy disks used by other devices for the use of 01/W files must also be formatted before they can be used to store Standard MIDI File data. When a disk is formatted, all its data is erased. Be careful not to format a disk containing important data (use the disk write protect slider to prevent accidental erasure).

- (1) Insert the disk into the disk drive.
- (2) Press [FORMAT] ([G]). Then, if you are sure you want to format the disk, press [YES] ([E]). To quit without formatting, press [NO] ([G]).

- Make sure that the disk write protect tab is in the write permit position.
- Formatting takes approximately 2 minutes.
- Never attempt to remove the disk while formatting is taking place (while the display shows "Now Formatting").
- When formatting is completed, the display will show "Completed". If an error message appears, re-insert the disk into the disk drive and try the operation once again. If an error appears again, try formatting a different disk. (For an explanation of each error message, see "Error messages" on page 211.)
- * The disk is formatted using the 720K MS-DOS format.
- * Follow P2-4 if you want to carry out the 01/W series formatting procedure.

MIDI IMPLEMENTATION

1. TRANSMITTED DATA

1-1 CHANNEL MESSAGES

Status	Second	Third	Description	E	N	A
1000 nnnn	Okkk kkkk	0100 0000	Note Off kkk kkkk-24~108 (61Keys+Transpose)			A
1001 nnnn	Okkk kkkk	0vvv vvvv	Note On kkk kkkk-24~108 (61Keys+Transpose) vvv vvvv-1~127			A
1010 nnnn	Okkk kkkk	0vvv vvvv	Poly Key Pressure (Seq Recorded Data)			TandQ
1011 nnnn	0000 0000	0000 0000	Bank Select(MSB) (BANK Key)			P
1011 nnnn	0000 0001	0vvv vvvv	Pitch Modulation (Joy Stick(+Y))			C
1011 nnnn	0000 0010	0vvv vvvv	VDF Modulation (Joy Stick(-Y))			C
1011 nnnn	0000 1010	0vvv vvvv	Panpot			C
1011 gggg	0000 1100	0vvv vvvv	Effect1 Control (Assignable Pedal1)			C
1011 gggg	0000 1101	0vvv vvvv	Effect2 Control (Assignable Pedal2)			C
1011 nnnn	0010 0000	0000 00bb	Bank Select(LSB) (BANK Key) bb=0~3:Bank A~D			P
1011 gggg	0000 0110	0vvv vvvv	Data Entry (MSB) (V. Slider, A. Pedal) *1			E
1011 nnnn	0000 0111	0vvv vvvv	Volume (Assignable Pedal)			C
1011 gggg	0010 0110	0vvv vvvv	Data Entry (LSB) (V. Slider, A. Pedal) *1			E
1011 nnnn	0100 0000	0000 0000	Damper Off (Damper Pedal)			C
1011 nnnn	0100 0000	0111 1111	Damper On (Damper Pedal)			C
1011 gggg	0101 1011	0000 0000	Effect1 Off (Assignable Pedal)			C
1011 gggg	0101 1011	0111 1111	Effect1 On (Assignable Pedal)			C
1011 gggg	0101 1100	0000 0000	Effect2 Off (Assignable Pedal)			C
1011 gggg	0101 1100	0111 1111	Effect2 On (Assignable Pedal)			C
1011 gggg	0110 0000	0000 0000	Data Increment (△ Key) *1			E
1011 gggg	0110 0001	0000 0000	Data Decrement (▽ Key) *1			E
1011 nnnn	0ccc cccc	0vvv vvvv	Control Data (Seq Recorded Data)			CandQ
			ccc cccc=00~101			
1100 nnnn	0ppp pppp	-----	Program Change (Program/Combi Change)			P
			ppp pppp=0~99			
1101 nnnn	0vvv vvvv	-----	Channel Pressure (After Touch)			T
1110 nnnn	0bbb bbbb	0bbb bbbb	Bender Change (Joy Stick(X))			C

nnnn : MIDI Channel No. (0~15) Usually Global Channel. When using Sequencer, each track's channel, and when in Combination Mode, each timbre's channel.

gggg : Always Global Channel No. (0~15)

ENA = A : Always Enabled

C : Enabled when Control Filter is ENA

P : Enabled when Program Filter is ENA

T : Enabled when After Touch Filter is ENA

E : Enabled when Exclusive Filter is ENA

Q : Enabled when Sequencer is Playing(T), Recording(R)

*1 : Prog. E. Prog. Combi. E. Combi Mode Only

1-2 SYSTEM COMMON MESSAGES

Status	Second	Third	Description
1111 0010	0111 1111	0hhh hhhh	Song Position Pointer 111 1111 : Least significant hhh hhhh : Most significant
1111 0011	000s ssss	-----	Song Select s ssss : Song No. = 0~29 (10~29:Card)

Transmits when in Sequencer Mode (Internal Clock)

1-3 SYSTEM REALTIME MESSAGES

Status	Description	
1111 1000	Timing Clock	*2
1111 1010	Start	*2
1111 1011	Continue	*2
1111 1100	Stop	*2
1111 1110	Active Sensing	

*2 : Transmits when in Sequencer Mode (Internal Clock)

1-4 UNIVERSAL SYSTEM EXCLUSIVE MESSAGES (DEVICE INQUIRY)

1111 0000 (F0)	Exclusive Status	
0111 1110 (7E)	Non Realtime Message	
0000 gggg (0g)	MIDI GLOBAL CHANNEL (DEVICE ID)	
0000 0110 (06)	INQUIRY MESSAGE	
0000 0010 (02)	IDENTITY REPLY	
0100 0010 (42)	KORG ID (MANUFACTURERS ID)	
0010 1011 (2B)	01/W Series ID (FAMILY CODE (LSB))	
0000 0000 (00)	(- - (MSB))	
0000 0000 (00)	(MEMBER CODE (LSB))	
0000 0000 (00)	(- - (MSB))	
0*** **** (**)	ROM No. 1~ (Minor Ver. (LSB))	
0000 0000 (00)	(- - (MSB))	
0*** **** (**)	SOFT VER. 1~ (Major VER. (LSB))	
0000 0000 (00)	(- - (MSB))	
1111 0111 (F7)	END OF EXCLUSIVE	

Transmits when INQUIRY MESSAGE REQUEST Received

*3 : m=0 : 01/W FD

1 : 01/W (no FD)

2 : 01R/W

3 : 01/W pro

4 : 01/W pro X

1-5 SYSTEM EXCLUSIVE MESSAGES

1st Byte = 1111 0000 (F0)	: Exclusive Status] EX. Header
2nd Byte = 0100 0010 (42)	: KORG ID	
3rd Byte = 0011 gggg (3g)	: Format ID g:Global ch.	
4th Byte = 0010 1011 (2B)	: 01/W Series ID	
5th Byte = 0fff ffff (ff)	: Function Code	
6th Byte = 0ddd dddd (dd)	: Data	
...	...	
LastByte = 1111 0111 (F7)	: End of Exclusive EOX

MIDI IMPLEMENTATION

8. DISK MODE

Function Code List

Func	Description	R	C	D	E
42	MODE DATA	○			
47	ALL DRUM SOUND(PCM CARD) NAME DUMP	○			
45	ALL MULTISOUND(PCM CARD) NAME DUMP	○			
4E	MODE CHANGE		○		
41	PARAMETER CHANGE		○		
53	DRUNKIT PARAMETER CHANGE		○		
40	PROGRAM PARAMETER DUMP	○	○		
4C	ALL PROGRAM PARAMETER DUMP	○	○	○	
49	COMBINATION PARAMETER DUMP	○	○		
4D	ALL COMBINATION PARAMETER DUMP	○	○	○	
48	ALL SEQUENCE DATA DUMP	○	○	○	
51	GLOBAL DATA DUMP	○	○	○	
52	DRUMS DATA DUMP	○	○	○	
50	ALL DATA(GLOBAL, DRUM, COMBI, PROG, SEQ) DUMP	○	○	○	
2B	RECEIVED MESSAGE FORMAT ERROR	○			○
23	DATA LOAD COMPLETED				○
24	DATA LOAD ERROR				○
21	WRITE COMPLETED				○
22	WRITE ERROR				○

Transmitted when

- R : Request Message is received
 C : Mode or No. is changed by SW
 D : Data dump by SW (Don't respond to Exclusive ENA.DIS)
 E : EX. Message received

2. RECOGNIZED RECEIVE DATA

2-1 CHANNEL MESSAGES

Status	Second	Third	Description	E	N	A
1000 nnnn	0kkk kkkk	0xxx xxxx	Note Off			A
1001 nnnn	0kkk kkkk	0000 0000	Note Off			A
1001 nnnn	0kkk kkkk	0vvv vvvv	Note On			A
			vvv vvvv=1~127			
1010 nnnn	0kkk kkkk	0vvv vvvv	Poly Key Pressure (For Seq. Recording)			TandQ
1011 nnnn	0000 0000	0000 0000	Bank Select(MSB)			P
1011 nnnn	0000 0001	0vvv vvvv	For Pitch Modulation			C
1011 nnnn	0000 0010	0vvv vvvv	For VDF Modulation			C
1011 nnnn	0000 0110	0vvv vvvv	Data Entry (MSB)	*1.3		E
1011 nnnn	0000 0111	0vvv vvvv	Volume			C
1011 nnnn	0000 1010	0vvv vvvv	Panpot			C
1011 nnnn	0000 1011	0vvv vvvv	Expression			C
1011 gggg	0000 1100	0vvv vvvv	Effect1 Control			C
1011 gggg	0000 1101	0vvv vvvv	Effect2 Control			C
1011 nnnn	0010 0000	0000 00bb	Bank Select(LSB)			P
			bb=0~3:Bank A~D			
1011 nnnn	0010 0110	0vvv vvvv	Data Entry (LSB)	*1.3		E
1011 nnnn	0100 0000	00xx xxxx	Damper Off			C
1011 nnnn	0100 0000	01xx xxxx	Damper On			C
1011 gggg	0101 1011	00xx xxxx	Effect1 Off			C
1011 gggg	0101 1011	01xx xxxx	Effect1 On			C
1011 gggg	0101 1100	00xx xxxx	Effect2 Off			C
1011 gggg	0101 1100	01xx xxxx	Effect2 On			C
1011 nnnn	0110 0000	0000 0000	DATA Increment	*1.3		E
1011 nnnn	0110 0001	0000 0000	DATA Decrement	*1.3		E
1011 nnnn	0110 0100	0000 00rr	RPN Parameter No. (LSB)	*3.4		E
1011 nnnn	0110 0101	0000 0000	RPN Parameter No. (MSB)	*3.4		E
1011 nnnn	0111 1001	0000 0000	Reset All Controllers			C
1011 nnnn	0ccc cccc	0vvv vvvv	Control Data (For Seq. Recording)			CandQ
			ccc cccc=00~101			
1011 gggg	0111 1010	0000 0000	Local Control Off			A
1011 gggg	0111 1010	0111 1111	Local Control On			A
1011 nnnn	0111 1011	0000 0000	All Notes Off			A
1011 nnnn	0111 110x	0000 0000	(All Notes Off)			A
1011 nnnn	0111 1110	000m mmmm	(All Notes Off)			A
			m mmm=0~16			
1011 nnnn	0111 1111	0000 0000	(All Notes Off)			A
1100 nnnn	0ppp pppp	---- ----	Program Combination Change	*2.3		P
1101 nnnn	0vvv vvvv	---- ----	Channel Pressure (After Touch)			T
1110 nnnn	0bbb bbbb	0bbb bbbb	Bender Change			C

x : Random

ENA Same as TRANSMITTED DATA

*1 : Prog. E. Prog. Combi. E. Combi Mode Only

*2 : Data beyond value of 99 are assigned a new value by subtracting 100 and change the Bank.
 ex. When in Bank A. and Received Prog No. is 110,
 Change the Bank to B. and change the Prog No. to 10.

*3 : After Processing (While Exclusive ENA).
 Transmits Exclusive Message[DATA LOAD COMPLETED]or[DATA LOAD ERROR].

*4 : rr = 0 : Pitch Bend Sensitivity
 = 1 : Fine Tune (When Received Ch = Global Ch. Master Tune)
 = 2 : Coarse Tune (Transpose)

2-2 SYSTEM COMMON MESSAGES

Status	Second	Third	Description
1111 0010	0111 1111	Ohhh hhhh	Song Position Pointer 111 1111 : Least significant hhh hhhh : Most significant
1111 0011	000s ssss	----	Song Select s ssss : Song No. = 0~29(10~29:Card)

Receive when in Sequencer Mode (External Clock)

2-3 SYSTEM REALTIME MESSAGES

Status	Description	
1111 1000	Timing Clock	*4
1111 1010	Start	*4
1111 1011	Continue	*4
1111 1100	Stop	*4
1111 1110	Active Sensing	

*4 : Receive when in Sequencer Mode (External Clock)

2-4 UNIVERSAL SYSTEM EXCLUSIVE MESSAGE (DEVICE INQUIRY)

Byte	Description
1111 0000 (F0)	EXCLUSIVE STATUS
0111 1110 (7E)	NON REALTIME MESSAGE
0*** **** (**)	MIDI CHANNEL
0000 0110 (06)	INQUIRY MESSAGE
0000 0001 (01)	INQUIRY REQUEST
1111 0111 (F7)	END OF EXCLUSIVE

*5 = 0~F : Receive if Global Channel

= 7F : Receive any Channel

2-5 SYSTEM EXCLUSIVE MESSAGES

* Don't receive when Sequencer is Playing,Recording

Function Code List

Func	Description	G	C	P	A	No.
12	MODE REQUEST	○	○	○	○	42
1F	ALL DRUM SOUND (PCM CARD)NAME DUMP REQUEST	○	○	○	○	47
16	ALL MULTISOUND (PCM CARD)NAME DUMP REQUEST	○	○	○	○	45
10	PROGRAM PARAMETER DUMP REQUEST			○		40
1C	ALL PROGRAM PARAMETER DUMP REQUEST	◎	○	○	○	4C
19	COMBINATION PARAMETER DUMP REQUEST		○	○		49
1D	ALL COMBINATION PARAMETER DUMP REQUEST	◎	○	○	○	4D
18	ALL SEQUENCE DATA DUMP REQUEST	◎	○	○	○	48
0E	GLOBAL DATA DUMP REQUEST	◎	○	○	○	51
0D	DRUMS DATA DUMP REQUEST	◎	○	○	○	52
0F	ALL DATA(GLOBAL, DRUMS, COMBI, PROG, SEQ)DUMP REQ	◎	○	○	○	50
11	PROGRAM WRITE REQUEST			○		21
1A	COMBINATION WRITE REQUEST		○			21
40	PROGRAM PARAMETER DUMP			○		23
4C	ALL PROGRAM PARAMETER DUMP	◎	○	○	○	23
49	COMBINATION PARAMETER DUMP		○	○		23
4D	ALL COMBINATION PARAMETER DUMP	◎	○	○	○	23
48	ALL SEQUENCE DATA DUMP	◎	○	○	○	23
51	GLOBAL DATA DUMP	◎	○	○	○	23
52	DRUMS DATA DUMP	◎	○	○	○	23
50	ALL DATA(GLOBAL, DRUMS, COMBI, PROG, SEQ) DUMP	◎	○	○	○	23
4E	MODE CHANGE	○	○	○	○	23
41	PARAMETER CHANGE		○	○		23
53	DRUM KIT PARAMETER CHANGE	○				23

Receive when in

G : GLOBAL Mode

(◎---Does not respond to Exclusive ENA.DIS in DATA DUMP Page)

C : COMBI, E. COMBI Mode

P : PROG, E. PROG Mode

A : ANY OTHER Mode

No. : MIDI Out Function No.

(transmitted after the message has been received.)

3. MIDI EXCLUSIVE FORMAT (R:Receive, T:Transmit)

(1) MODE REQUEST R

Byte	Description	
F0. 42. 3n. 2B	EXCLUSIVE HEADER	
0001 0010	MODE REQUEST	12H
1111 0111	EOX	

Receives this message, and transmits Func=42 message.

(2) PROGRAM PARAMETER DUMP REQUEST R

Byte	Description	
F0. 42. 3n. 2B	EXCLUSIVE HEADER	
0001 0000	PROGRAM PARAMETER DUMP REQUEST	10H
1111 0111	EOX	

Receives this message, and transmits Func=40 or Func=24 message.

(3) ALL DRUM SOUND (PCM CARD) NAME DUMP REQUEST R

Byte	Description	
F0. 42. 3n. 2B	EXCLUSIVE HEADER	
0001 1111	ALL DRUM SOUND NAME DUMP REQUEST	1FH
0000 0000		
1111 0111	EOX	

Receives this message, and transmits Func=47 or Func=24 message.

(4) ALL MULTISOUND (PCM CARD) NAME DUMP REQUEST R

Byte	Description	
F0. 42. 3n. 2B	EXCLUSIVE HEADER	
0001 0110	ALL MULTISOUND NAME DUMP REQUEST	16H
0000 0000		
1111 0111	EOX	

Receives this message, and transmits Func=45 or Func=24 message.

(5) ALL PROGRAM PARAMETER DUMP REQUEST R

Byte	Description	
F0. 42. 3n. 2B	EXCLUSIVE HEADER	
0001 1100	ALL PROGRAM PARAMETER DUMP REQUEST	1CH
0000 0000		
1111 0111	EOX	

Receives this message, and transmits Func=4C or Func=24 message.

(6) COMBINATION PARAMETER DUMP REQUEST R

Byte	Description	
F0. 42. 3n. 2B	EXCLUSIVE HEADER	
0001 1001	COMBINATION PARAMETER DUMP REQUEST	19H
1111 0111	EOX	

Receives this message, and transmits Func=49 or Func=24 message.

(7) ALL COMBINATION PARAMETER DUMP REQUEST R

Byte	Description	
F0. 42. 3n. 2B	EXCLUSIVE HEADER	
0001 1101	ALL COMBI. PARAMETER DUMP REQUEST	1DH
0000 0000		
1111 0111	EOX	

Receives this message, and transmits Func=4D or Func=24 message.

(8) ALL SEQUENCE DATA DUMP REQUEST R

Byte	Description	
F0. 42. 3n. 2B	EXCLUSIVE HEADER	
0001 1000	ALL SEQUENCE DATA DUMP REQUEST	18H
0000 0000		
1111 0111	EOX	

Receives this message, and transmits Func=48 or Func=24 message.

(9) GLOBAL DATA DUMP REQUEST R

Byte	Description	
F0. 42. 3n. 2B	EXCLUSIVE HEADER	
0000 1110	GLOBAL DATA DUMP REQUEST	0EH
0000 0000		
1111 0111	EOX	

Receives this message, and transmits Func=51 or Func=24 message.

(10) DRUMS DATA DUMP REQUEST R

Byte	Description	
F0. 42. 3n. 2B	EXCLUSIVE HEADER	
0000 1101	DRUMS DATA DUMP REQUEST	0DH
0000 0000		
1111 0111	EOX	

Receives this message, and transmits Func=52 or Func=24 message.

(11) ALL DATA (GLOB. DRUMS, COMBI. PROG. SEQ) DUMP REQUEST R

Byte	Description	
F0. 42. 3n. 2B	EXCLUSIVE HEADER	
0000 1111	ALL DATA (GLB. CMB. PRG. SEQ) DUMP REQ	0FH
0000 0000		
1111 0111	EOX	

Receives this message, and transmits Func=50 or Func=24 message.

(12) PROGRAM WRITE REQUEST R

Byte	Description	
F0. 42. 3n. 2B	EXCLUSIVE HEADER	
0001 0001	PROGRAM WRITE REQUEST	11H
0000 00bb	Write Program Bank	(NOTE 1)
0ppp pppp	Write Program No. (0-99)	
1111 0111	EOX	

Receives this message, writes the data and transmits Func=21 or Func=22 message.

(13) COMBINATION WRITE REQUEST R

Byte	Description	
F0. 42. 3n. 2B	EXCLUSIVE HEADER	
0001 1010	COMBINATION WRITE REQUEST	1AH
0000 00bb	Write Combination Bank	(NOTE 1)
0ppp pppp	Write Combination No. (0-99)	
1111 0111	EOX	

Receives this message, writes the data and transmits Func=21 or Func=22 message.

(14) PROGRAM PARAMETER DUMP R, T

Byte	Description	
F0. 42. 3n. 2B	EXCLUSIVE HEADER	
0100 0000	PROGRAM PARAMETER DUMP	40H
0ddd dddd	Data	(NOTE 2.3)
⋮	⋮	
1111 0111	EOX	

Receives this message & data, and transmits Func=23 or Func=24 message.

Receives Func=10 message, and transmits this message & data.

When the Program No. is changed by SW, transmits this message & data.

(15) ALL PROGRAM PARAMETER DUMP R. T

Byte	Description
F0. 42. 3n. 2B	EXCLUSIVE HEADER
0100 1100	PROGRAM PARAMETER DUMP 4CH
0000 0000	
0ddd dddd	Data (NOTE 2.4)
⋮	⋮
1111 0111	EOX

Receives this message & data, and transmits Func=23 or Func=24 message.
 Receives Func=1C message, and transmits this message & data.
 Transmits this message & data when DATA DUMP is executed.

(16) COMBINATION PARAMETER DUMP R. T

Byte	Description
F0. 42. 3n. 2B	EXCLUSIVE HEADER
0100 1001	COMBINATION PARAMETER DUMP 49H
0ddd dddd	Data (NOTE 2.5)
⋮	⋮
1111 0111	EOX

Receives this message & data, and transmits Func=23 or Func=24 message.
 Receives Func=19 message, and transmits this message & data.
 When the Combi No. is changed by SW, transmits this message & data.

(17) ALL COMBINATION PARAMETER DUMP R. T

Byte	Description
F0. 42. 3n. 2B	EXCLUSIVE HEADER
0100 1101	ALL COMBINATION PARAMETER DUMP 4DH
0000 0000	
0ddd dddd	Data (NOTE 2.6)
⋮	⋮
1111 0111	EOX

Receives this message & data, and transmits Func=23 or Func=24 message.
 Receives Func=1D message, and transmits this message & data.
 Transmits this message & data when DATA DUMP is executed.

(18) ALL SEQUENCE DATA DUMP R. T

Byte	Description
F0. 42. 3n. 2B	EXCLUSIVE HEADER
0100 1000	ALL SEQUENCE DATA DUMP 48H
0000 0000	
0sss ssss	Seq. Data Size (NOTE 7-1)
⋮	⋮
0ddd dddd	Control Data (NOTE 2.7-2)
⋮	⋮
0ddd dddd	Sequence Data (NOTE 2.7-3)
⋮	⋮
1111 0111	EOX

Receives this message & data, and transmits Func=23 or Func=24 message.
 Receives Func=18 message, and transmits this message & data.
 Transmits this message & data when DATA DUMP is executed.

(19) GLOBAL DATA DUMP R. T

Byte	Description
F0. 42. 3n. 2B	EXCLUSIVE HEADER
0101 0001	GLOBAL DATA DUMP 51H
0000 0000	
0ddd dddd	Data (NOTE 2.8)
⋮	⋮
1111 0111	EOX

Receives this message & data, and transmits Func=23 or Func=24 message.
 Receives Func=0E message, and transmits this message & data.
 Transmits this message & data when DATA DUMP is executed.

(20) DRUMS DATA DUMP R. T

Byte	Description
F0. 42. 3n. 2B	EXCLUSIVE HEADER
0101 0010	DRUMS DATA DUMP 52H
0000 0000	
0ddd dddd	Data (NOTE 2.9)
⋮	⋮
1111 0111	EOX

Receives this message & data, and transmits Func=23 or Func=24 message.
 Receives Func=0D message, and transmits this message & data.
 Transmits this message & data when DATA DUMP is executed.

(21) ALL DATA(GLOBAL, DRUMS, COMBI, PROG, SEQ.) DUMP R. T

Byte	Description
F0. 42. 3n. 2B	EXCLUSIVE HEADER
0101 0000	ALL DATA(GLBL, COMBI, PROG, SEQ.) DUMP 50H
0000 0000	
0sss ssss	Seq. Data Size (NOTE 7-1)
⋮	⋮
0ddd dddd	Data (NOTE 2.10)
⋮	⋮
1111 0111	EOX

Receives this message & data, and transmits Func=23 or Func=24 message.
 Receives Func=0F message, and transmits this message & data.
 Transmits this message & data when DATA DUMP is executed.

(22) MODE CHANGE R. T

Byte	Description
F0. 42. 3n. 2B	EXCLUSIVE HEADER
0100 1110	MODE CHANGE 4EH
0000 mmmm	Mode Data (NOTE 11)
0000 0000	
1111 0111	EOX

Receives this message & data, changes the Mode, and transmits Func=23 or Func=24.
 When the Mode is changed by SW, transmits this message & data.

(23) PARAMETER CHANGE R. T

Byte	Description
F0. 42. 3n. 2B	EXCLUSIVE HEADER
0100 0001	PARAMETER CHANGE 41H
0000 0ppp	Parameter Page (TABLE 6.7)
0000 0sss	Parameter Stage (TABLE 6.7)
0000 0ppp	Parameter Position (TABLE 6.7)
0vvv vvvv	Value (LSB bit6-0) (NOTE 12)
0vvv vvvv	Value (MSB bit13-7) (NOTE 12)
1111 0111	EOX

Receives this message & data, and transmits Func=23 or Func=24 message.
When the Parameter No. is changed by SW, transmits this message & data.

(24) DRUM-KIT PARAMETER CHANGE R

Byte	Description
F0. 42. 3n. 2B	EXCLUSIVE HEADER
0101 0011	DRUM KIT PARAMETER CHANGE 53H
0000 0000	
0000 000n	Drum Kit No. (NOTE 13-1)
00ss ssss	Index No. (NOTE 13-2)
0000 0ppp	Parameter No. (TABLE 8)
0vvv vvvv	Value (LSB bit6~0) (NOTE 12)
0vvv vvvv	Value (MSB bit13~7) (NOTE 12)
1111 0111	EOX

Receives this message & data, and transmits Func=23 or Func=24 message.

(25) ALL DRUM SOUND (PCM CARD)NAME T

Byte	Description
F0. 42. 3n. 2B	EXCLUSIVE HEADER
0100 0111	ALL DRUM SOUND NAME 47H
0000 0000	
0nnn nnnn	Number of Drum Sound (NOTE 14-1)
0ddd dddd	Data (NOTE 14-2)
⋮	⋮
1111 0111	EOX

Receives Func=1F message, and transmits this message & data or transmits Func=24 message.

(26) ALL MULTISOUND (PCM CARD)NAME T

Byte	Description
F0. 42. 3n. 2B	EXCLUSIVE HEADER
0100 0101	ALL MULTISOUND NAME 45H
0000 0000	
0nnn nnnn	Number of Multisound (NOTE 15-1)
0ddd dddd	Data (NOTE 15-2)
⋮	⋮
1111 0111	EOX

Receives Func=16 message, and transmits this message & data or transmits Func=24 message.

(27) MODE DATA T

Byte	Description
F0. 42. 3n. 2B	EXCLUSIVE HEADER
0100 0010	MODE DATA 42H
0000 mmmm	Mode Data (NOTE 11)
0000 0000	
00cc 00vv	Card Variation (NOTE 16)
0000 01cc	PCM Memory Status (NOTE 17)
1111 0111	EOX

Receives Func=12 message, and transmits this message & data.

(28) MIDI IN DATA FORMAT ERROR T

Byte	Description
F0. 42. 3n. 2B	EXCLUSIVE HEADER
0010 0110	MIDI IN DATA FORMAT ERROR 26H
1111 0111	EOX

Transmits this message when there is an error in the MIDI IN message (ex. data length).

(29) DATA LOAD COMPLETED T

Byte	Description
F0. 42. 3n. 2B	EXCLUSIVE HEADER
0010 0011	DATA LOAD COMPLETED 23H
1111 0111	EOX

Transmits this message when DATA LOAD.PROCESSING have been completed.

(30) DATA LOAD ERROR T

Byte	Description
F0. 42. 3n. 2B	EXCLUSIVE HEADER
0010 0100	DATA LOAD ERROR 24H
1111 0111	EOX

Transmits this message when DATA LOAD.PROCESSING have not been completed (ex. protected).

(31) WRITE COMPLETED T

Byte	Description
F0. 42. 3n. 2B	EXCLUSIVE HEADER
0010 0001	WRITE COMPLETED 21H
1111 0111	EOX

Transmits this message when DATA WRITE MIDI has been completed.

(32) WRITE ERROR T

Byte	Description
F0. 42. 3n. 2B	EXCLUSIVE HEADER
0010 0010	WRITE ERROR 22H
1111 0111	EOX

Transmits this message when DATA WRITE MIDI has not been completed.

NOTE 1 : PROGRAM COMBINATION BANK

- bb=0 : Bank A
- 1 : Bank B
- 2 : Bank C
- 3 : Bank D

NOTE 2 :

DUMP DATA CONVERT n=0~ for NOTE 3. 4. 5. 6. 7-2. 7-3. 8. 9. 10. 14-2. 15-2

DATA (1set = 8bit x 7Byte)

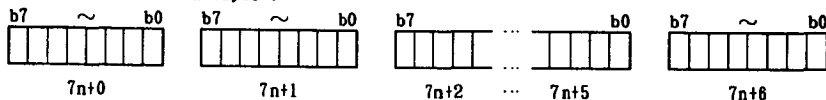

MIDI DATA (1set = 7bit x 8Byte)

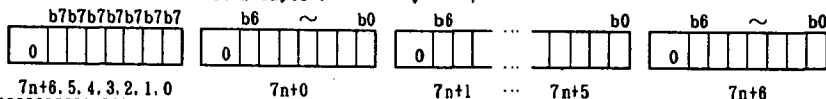

NOTE 3 : PROGRAM PARAMETER (IN CURRENT BUFFER) DUMP FORMAT (See TABLE 1 , NOTE 2)

[Parameter No. 00], ..., [Parameter No. 171]
172Byte = 7x24+4 → 8x24+(1+4) = 197Byte

NOTE 4 : ALL PROGRAM PARAMETER (IN INTERNAL MEMORY) DUMP FORMAT (See NOTE 2)

[Prog A 00 (172Byte)], ..., [Prog B 99 (172Byte)]
172x200Byte = 7x4914+2 → 8x4914+(1+2) = 39315Byte (12.6Sec)

NOTE 5 : COMBINATION PARAMETER (IN CURRENT BUFFER) DUMP FORMAT (See TABLE 2 , NOTE 2)

[Parameter No. 00], ..., [Parameter No. 127]
128Byte = 7x18+2 → 8x18+(1+2) = 147Byte

NOTE 6 : ALL COMBINATION PARAMETER (IN INTERNAL MEMORY) DUMP FORMAT (See NOTE 2)

[Combi. A 00 (128Byte)], ..., [Combi. B 99 (128Byte)]
128x200Byte = 7x3657+1 → 8x3657+(1+1) = 29258Byte (9.4Sec)

NOTE 7 : ALL SEQUENCE DATA (IN INTERNAL MEMORY) DUMP FORMAT

7-1 : Sequence Data Size (2Byte) 4Step/1Size

[Data Size (bit6-0)],
[Data Size (bit13-7)]

7-2 : Control Data Dump Format (3462Byte) (See TABLE 5-1 , NOTE 2)

[Control Data (Song Size(272) x 10 = 2720Byte)],
[Pattern Data (200Byte)],
[Song0-Tr. 1 Addr (2Byte)], ..., [Song0-Tr. 16 Addr], [Song0-Tempo Track Addr],
[Song1-Tr. 1 Addr], ..., [Song9-Tr. 16 Addr], [Song9-Tempo Track Addr] (340Byte),
[Pattern0 Addr (2Byte)], ..., [Pattern99 Addr] (200Byte),
[Pattern End Addr (2Byte)]

7-3 : Sequence Data Dump Format (See TABLE 5-2 , NOTE 2)

[Sequence 1st Data(4Byte)], ..., [Seq. nth Data]
n : Seq. Data Step = 0 ~ 48000 (01/W PD)
= 0 ~ 7320 (01/W)

3462Byte+4x[Seq. Data Step]Byte = 7xA+B → 8xA+(1+B)Byte

∴ 8-1, 8-2, 8-3 = 2+8xA+(1+B)Byte (1.3~71.5Sec)

NOTE 8 : GLOBAL DATA (IN INTERNAL MEMORY) DUMP FORMAT (See TABLE 3 , NOTE 2)

[Global Data (21Byte)]
21=7x3+0 → 8x3 =24Byte

NOTE 9 : DRUMS DATA (IN INTERNAL MEMORY) DUMP FORMAT (See TABLE 4 , NOTE 2)

[Drum Kit Data (7x60x2x2Byte)]
1680Byte =7x240+0 → 8x240 =1920Byte (0.6Sec)

NOTE 10 : ALL DATA (GLOBAL, DRUMS, COMBI, PROG, SEQ) DUMP FORMAT (See NOTE 2)

[Global Data], (See NOTE 8)
[Drums Data], (See NOTE 9)
[All Combination Parameter Data], (See NOTE 6)
[All Program Parameter Data], (See NOTE 4)
[All Sequence Data] (See NOTE 7-2.7-3)
21+1680+34400+25600+3462+4x[Seq. Data Step]Byte = 7xC+D
→ 8xC+(1+D)Byte (23.9~94.1Sec)

NOTE 11 : mmm = 0 : COMBINATION 3 : EDIT PROG. 8 : DISK

- 1 : EDIT COMBI. 4 : GLOBAL
- 2 : PROGRAM 6 : SEQUENCER

NOTE 12 : VALUE DATA FORMAT (Use at PARAMETER CHANGE, DRUM KIT PARAMETER CHANGE)

Bit15-13 of Value Data is the Sign Flag, and each bit has the same value

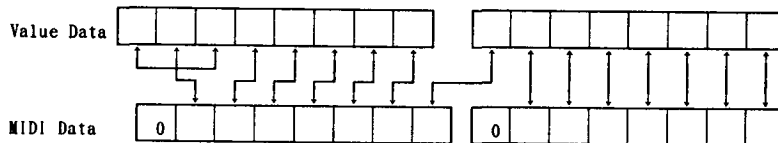

NOTE 13-1 : n=0 : Drum Kit1
1 : Drum Kit2

NOTE 13-2 : ss ssss : Index (=0~59)

NOTE 14-1 : NUMBER OF DRUMSOUND
nnn nnnn = 1 ~ 100

NOTE 14-2 : ALL DRUM SOUND (PCM CARD) NAME DATA FORMAT
[Drum Sound 1 Name (10Byte)], ..., [Drum Sound n Name (10Byte)]
n : Drum Sound Number

NOTE 15-1 : NUMBER OF MULTISOUND
nnn nnnn = 1 ~ 100

NOTE 15-2 : ALL MULTISOUND (PCM CARD) NAME DATA FORMAT
[Multisound 1 Name (10Byte)], ..., [Multisound n Name (10Byte)]
n : Multisound Number

NOTE 16 : cc, vv = 0.0 : Card Off
= 0.1 : NG Card (ROM)
= 0.2 : - - (RAM)
cc = 1 : ROM Card vv = bit0...Bank C, bit1...Bank D
= 2 : RAM Card (Protect Off) = 0 : Prog/Combi Data
= 3 : - - (- On) = 1 : Seq Data

NOTE 17 : cc = 0 : Card Off
= 1 : NG Card
= 2 : PCM Card In

SEQUENCER CONTROL DATA

No.	PARAMETER	DATA(Hex) : VALUE
SONG 0 CONTROL DATA		
00	MIDI Channel(Tr.1)	00~0F : 1~16
15	MIDI Channel(Tr.16)	
16	STATUS (Tr.1)	*11
31	STATUS (Tr.16)	
32	BEAT	*12
33	TEMPO	28~F0 : 40~240
34	PROTECT (Tr.1)	bit0=0:OFF, =1:ON
	PROTECT (Tr.8)	bit7
35	PROTECT (Tr.9)	bit0=0:OFF, =1:ON
	PROTECT (Tr.16)	bit7
36	NEXT SONG NO.	*13
37	SONG NAME (Head)	20~7F : ~
46	SONG NAME (Tail)	
47	(RESERVE)	00
48	EFFECT PARAMETER	*15
76		
TRACK 1 CONTROL DATA		
77	PROGRAM NO.	*6
78	OUTPUT LEVEL	00~7F : 00~127
79	KEY TRANSPOSE	E8~18 : -24~24
80	DETUNE	CE~32 : -50~50
81	PAN	00~0F *5
82	KEY WINDOW TOP	00~7F : C-1~G9
83	KEY WINDOW BOTTOM	00~7F : C-1~G9
84	VEL WINDOW TOP	01~7F : 01~127
85	VEL WINDOW BOTTOM	01~7F : 01~127
86	CONTROL FILTER	*7
87	MIDI CHANNEL	00~0F : 1~16
TRACK 2~16 CONTROL DATA		
88	SAME AS TRACK 1(77~87) x 15	
252		
253	(RESERVE)	00
258		
259	METRONOME LEVEL	00~63 : 0~99
260	METRONOME PAN	00~0D *5
261	METRONOME LEAD IN	0~2 : 0~2
262	TEMPO TRACK ON/OFF	0:OFF, 1:ON
263	(RESERVE)	00
271		
SONG 1~9 CONTROL DATA		
272	SAME AS SONG 0(00~271) x 9	
2719		

(TABLE 5-1)

PATTERN 0 CONTROL DATA		
2720	BEAT	*12
2721	LENGTH	01~63 : 1~99
PATTERN 1~99 CONTROL DATA		
2722	SAME AS PATTERN 0(2720,2721) x 99	
2919		
SONGO-TRACK1 DATA ADDRESS		
2920	DATA ADDRESS(LSB)	
2921	(MSB)	0000 (Start Addr)
SONGO-TRACK2 ~ TRACK16 DATA ADDRESS		
2922	SAME AS SONGO-TRACK1 ADDRESS(2920,2921) x 15	
2951		
SONGO TEMPO TRACK DATA ADDRESS		
2952	DATA ADDRESS (LSB)	
2953	(MSB)	
SONG1~9 TRACK DATA ADDRESS		
2954	SAME AS SONGO TRACK ADDRESS(2920~2953) x 9	
3259		
PATTERN 0 DATA ADDRESS		
3260	DATA ADDRESS (LSB)	
3261	(MSB)	
PATTERN 1 ~ PATTERN 99 DATA ADDRESS		
3262	SAME AS PATTERN 0(3260,3261)	
3459		
3460	End Pattern Addr(L)	
3461	(H)	

SEQUENCE DATA (TABLE 5-2)

No.	PARAMETER	DATA(Hex) : VALUE
SEQUENCE DATA 1		
3462	DATA (1-L)	*14
3463	DATA (1-H)	*14
3464	DATA (2-L)	*14
3465	DATA (2-H)	*14
SEQUENCE DATA 2 ~		
3466	SAME AS SEQUENCE DATA 1(3462~3465)	

*10 : bit0~3 = 00 : 10:00

0A : 00:10
 0B : C
 0C : C+D
 0D : D
 0E : ALL
 0F : PRG
 bit4~7 = 0 : EX Off
 1 : EX Group1
 9 : EX Group9

* 11 : bit0.1 = 0 : OFF

1 : INT
 2 : EXT
 3 : BOTH
 bit2 = 0 : Play. = 1 : Mute

* 12 : bit0~5 10~18 : 1/4 ~ 9/4
 20~2F : 1/8 ~ 16/8
 30~3F : 1/16 ~ 16/16

bit7 = 0 : High Resolution
 1 : Low Resolution

* 13 : bit0~3 = 0 : Song0

9 : Song9

* 14 : SEQUENCE DATA FORMAT

DATA(1-H) DATA(1-L) DATA(2-H) DATA(2-L)

↓ ↓ ↓ ↓
 *14-1 NOTE ON/OFF

lvvv vvv t	tttt tttt	kkkk kkk g	gggg gggg
Velocity	Event Time	Key No.	Length
t = 30 : J	.t = IFE : Tie from Last Bar		
g = 30 : J	.g = IFE : Tie to Next Bar		

*14-2 PITCH BEND

0001 000 t	tttt tttt	0 vvv vvvv	0 vvv vvvv
		Event Time	Value(H) Value(L)

*14-3 AFTER TOUCH

0010 000 t	tttt tttt	0000 0000	0 vvv vvvv
		Event Time	Value

*14-4 PROGRAM CHANGE

0011 000 t	tttt tttt	0000 00bb	0ppp pppp
		Event Time	Bank Program No.

p=00~C7:00~99

*14-5 CONTROL CHANGE

0100 000 t	tttt tttt	0vvv vvvv	0ccc cccc
		Event Time	Value Control No.

c= 00~65 : Same as MIDI Control Change
 = 66 : Assignable Pedal

*14-6 POLY KEY PRESSURE

0101 000 t	tttt tttt	0 vvv vvvv	0 kkk kkkk
		Event Time	Value Key No.

*14-7 BAR

0110 00bb	bbbb bbbb	xx ss ssss	0ppp pppp
		Bar No. Type Beat	Pattern No.

xx= 00 : Don't use Pattern
 = 10 : Pattern continual
 = 11 : Pattern Start
 s= 10~18 : 1/4~9/4
 = 20~2F : 1/8~16/8
 = 30~3F : 1/16~16/16

*14-8 TRACK END

0111 000 t	tttt tttt	0000 00bb	bbbb bbbb
		Event Time	Last Bar No.

*15 EFFECT PARAMETER

No.	PARAMETER	DATA(Hex) : VALUE
(00)	Effect 1 Type No.	0.1~2F:OFF.1~47
(01)	- 2 - -	0.1~2F:OFF.1~47
(02)	- 1 L-Ch E. Balnc	00~64 : 00~100
(03)	- 1 R-Ch -	00~64 : 00~100
(04)	- 2 L-Ch -	00~64 : 00~100
(05)	- 2 R-Ch -	00~64 : 00~100
(06)	Output 3 Pan	00.01~65 *15-1
(07)	- 4 -	00.01~65 *15-1
(08)	Effect 1/O	bit5~0 *15-2
(09)	Effect 1 Parameter	*15-3
(16)		
(17)	Effect 1 Mod Source	00~0D *15-4
(18)	Effect 1 Mod Amount	F1~0F : -15~15
(19)	Effect 2 Parameter	*15-3
(26)		
(27)	Effect 2 Mod Source	00~0D *15-4
(28)	Effect 2 Mod Amount	F1~0F : -15~15

*15-1 : 00 : Off *15-2 :

01 : R bit0=0:Efct1 L-Ch Off.=1:On
 02 : 01:99 bit1=0: - 1 R-Ch Off.=1:On
 ... bit2=0: - 2 L-Ch Off.=1:On
 64 : 99:01 bit3=0: - 2 R-Ch Off.=1:On
 65 : L bit4.5=0:Serial 1:Parallel

2:Parallel12

*15-3 : Effect Parameter (8Byte) 47 Type

offset	PARAMETER	DATA(Hex) : VALUE
1~3:Hall. (4:5:Room. 6:Live Stage)		
(00)	Reverb Time	00~61(2F):0.2~9.9(4.9)
(01)	(NUL)	00
(02)	High Damp	00~63 : 00~99
(03)	Pre Delay	00~C8 : 00~200
(04)	E. R Level	00~63 : 00~99
(05)	(NUL)	00
(06)	EQ High	F4~0C : -12~12
(07)	EQ Low	F4~0C : -12~12

Don't display NUL from here. and that must be 00
7:Wet Plate. 8:Dry Plate. 9:Spring

(00)	Pre Delay(L)	00~190: 00~400
(01)	- (H)	
(02)	E. R Level	01~0A : 01~10
(03)	Reverb Time	00~63 : 00~99
(04)	High Damp	00~63 : 00~99
(06)	EQ Low	F4~0C : -12~12
(07)	EQ High	F4~0C : -12~12

10~12:Early Reflection 1.2.3

(00)	E. R Time	00~46 : 100~800
(01)	Pre Delay	00~C8 : 00~200
(06)	EQ High	F4~0C : -12~12
(07)	EQ Low	F4~0C : -12~12

13:Stereo Delay. 14:Cross Delay

(00)	Delay Time L (L)	00~1F4 : 00~500
(01)	- - (H)	
(02)	Feed Back	9D~63 : -99~99
(03)	High Damp	00~63 : 00~99
(04)	Delay Time R (L)	00~1F4 : 00~500
(05)	- - (H)	
(06)	EQ High	F4~0C : -12~12
(07)	EQ Low	F4~0C : -12~12

15:Dual Delay

(00)	Delay Time L (L)	00~1F4 : 00~500
(01)	- - (H)	
(02)	Feed Back L	9D~63 : -99~99
(03)	High Damp L	00~63 : 00~99
(04)	Delay Time R (L)	00~1F4 : 00~500
(05)	- - (H)	
(06)	Feed Back R	9D~63 : -99~99
(07)	High Damp R	00~63 : 00~99

16~18:Multi Tap Delay 1.2.3

(00)	Delay Time 1(L)	00~1F4 : 00~500
(01)	- - (H)	
(02)	Delay Time 2(L)	00~1F4 : 00~500
(03)	- - (H)	
(04)	Feed back	9D~63 : -99~99
(06)	EQ Low	F4~0C : -12~12
(07)	EQ High	F4~0C : -12~12

19.20:Stereo Chorus 1.2

(00)	Mod Depth	00~63 : 00~99
(01)	Mod Speed	00~D8 *15-3-2
(02)	MG Status *15-3-3	bit0=0:Sin. =1:Tri bit1 ← 1 bit2 ← 0
(04)	Delay Time	00~C8 : 00~200
(06)	EQ High	F4~0C : -12~12
(07)	EQ Low	F4~0C : -12~12

21:Quadrature Chorus. 22:X Over Chorus

(00)	Delay Time L	00~FA : 00~250
(01)	Delay Time R	00~FA : 00~250
(02)	Mod Speed	01~63 : 01~99
(03)	Mod Depth	00~63 : 00~99
(04)	Mod Waveform	EB~14 *15-3-4
(06)	EQ Low	F4~0C : -12~12
(07)	EQ High	F4~0C : -12~12

23:Harmonic Chorus

(00)	Delay Time L (L)	00~1F4 : 00~500
(01)	- - (H)	
(02)	Delay Time R (L)	00~1F4 : 00~500
(03)	- - (H)	
(04)	Mod Speed	01~63 : 01~99
(05)	Mod Depth	00~63 : 00~99
(06)	Filter Split Point	00~12 : 00~18

24:Symphonic Ensemble

(00)	Mod Depth	00~63 : 00~99
(06)	EQ High	F4~0C : -12~12
(07)	EQ Low	F4~0C : -12~12

25.26:Flanger1.2. 27:X Over Flanger

(00)	Delay Time	00~C8 : 00~200
(01)	Mod Depth	00~63 : 00~99
(02)	Mod Speed	01~63 : 01~99
(03)	Resonance	9D~63 : -99~99
(06)	EQ Low	F4~0C : -12~12
(07)	EQ High	F4~0C : -12~12

28:Exciter

(00)	Blend	9D~63 : -99~99
(01)	Emphatic Point	00~09 : 01~10
(06)	EQ High	F4~0C : -12~12
(07)	EQ Low	F4~0C : -12~12

29:Enhancer

(00)	Harmonic Density	01~63 : 01~99
(01)	Hot Spot	01~14 : 01~20
(02)	Stereo Width	00~63 : 00~99
(03)	Delay	01~63 : 01~99
(06)	EQ Low	F4~0C : -12~12
(07)	EQ High	F4~0C : -12~12

30:Distortion. 31:Over Drive

(00)	Drive (Edge)	01~6F : 01~111
(01)	Hot Spot	00~63 : 00~99
(02)	Resonance	00~63 : 00~99
(03)	Out Level	00~63 : 00~99
(06)	EQ Low	F4~0C : -12~12
(07)	EQ High	F4~0C : -12~12

32.33:Phaser 1.(2)

(00)	Mod Depth	00~63 : 01~99
(01)	Mod Speed	00~D8 : *15-3-2
(02)	MG Status *15-3-3	bit0=0:Sin. =1:Tri bit1 ← 1.(0) bit2 ← 0
(03)	Feedback	9D~63 : -99~99
(04)	Manual	00~63 : 00~99

34:Rotary Speaker

(00)	Vibrato Depth	00~0F : 00~15
(01)	Acceleration	01~0F : 01~15
(02)	Slow Speed	01~63 : 01~99
(03)	Fast Speed	01~63 : 01~99

35:Auto Pan. (36:Tremolo)

(00)	Depth	00~63 : 00~99
(01)	Speed	00~D8 : *15-3-2
(02)	MG Status *15-3-3	bit0=0:Sin. =1:Tri bit1 ← 1.(0) bit2 ← 0
(03)	Shape	9D~63 : -99~99
(06)	EQ High	F4~0C : -12~12
(07)	EQ Low	F4~0C : -12~12

37:Parametric EQ

(00)	Low Freq	00~1D : 00~29
(01)	Low Gain	F4~0C : -12~12
(02)	Mid Freq	00~63 : 00~99
(03)	Mid Gain	F4~0C : -12~12
(04)	Mid Width	00~63 : 00~99
(05)	High Freq	00~1D : 00~29
(06)	High Gain	F4~0C : -12~12

38:Chorus-Delay. 39:Flanger-Delay

(00)	Delay Time	00~32 : 00~50
(01)	Mod Speed	01~63 : 01~99
(02)	Mod Depth	00~63 : 00~99
(03)	Feed back	9D~63 : -99~99
(04)	Delay Time	00~E1 : 00~450
(05)	Feed back	9D~63 : -99~99

40:Delay / Hall

(00)	Delay Time (L)	00~1F4 : 00~500
(01)	Delay Time (H)	
(02)	Feed Back	9D~63 : -99~99
(03)	High Damp	00~63 : 00~99
(04)	Reverb Time	00~61 : 0.2~9.9
(06)	High Damp	00~63 : 00~99
(07)	Pre Delay	00~96 : 00~150

41:Delay / Room

(00)	Delay Parameter	*15-3-1
(03)		
(04)	Reverb Time	00~2F : 0.2~4.9
(06)	High Damp	00~63 : 00~99
(07)	Pre Delay	00~96 : 00~150

42:Delay / Chorus. (43:Delay / Flanger)

(00)	Delay Parameter	*15-3-1
(03)		
(04)	Depth	00~63 : 00~99
(05)	Speed	00~D8 *15-3-2
(06)	MG Status *15-3-3	bit0=0:S.=1:T(←0) bit1 ← 0 bit2 ← 0.(←1)
(07)	Feed Back	0.(9D~63:-99~99)

44:Delay / Distortion. 45:Delay / Over Drive

(00)	Delay Time (L)	00~1F4 : 00~500
(01)	- (H)	
(02)	Feed back	9D~63 : -99~99
(03)	Drive	01~6F : 01~111
(04)	Hot Spot	01~63 : 01~99
(05)	Resonance	00~63 : 00~99
(06)	Out Level	01~63 : 01~99

46:Delay / Phaser

(00)	Delay Parameter	*15-3-1
(03)		
(04)	Depth	00~63 : 00~99
(05)	Speed	00~D8 *15-3-2
(06)	Feedback	9D~63 : -99~99

47:Delay / Rotary Speaker

(00)	Delay Time (L)	00~1F4 : 00~500
(01)	- (H)	
(02)	Feed back	9D~63 : -99~99
(03)	Acceleration	01~0F : 01~15
(04)	Slow Speed	01~63 : 01~99
(05)	Fast Speed	01~63 : 01~99

*15-3-1 : Delay Parameter
Same as 40-(00)~(03)

*15-3-2 : Data(Hex) Value[Hz]
00~63 0.03~ 3.00 (0.03step)
64~C7 3.1 ~13.0 (0.1 step)
C8~D8 14 ~30.0 (1 step)

*15-3-3 : MG Status
bit0 : Wave Form =0:Sin. =1:Tri
bit1 : Phase =0:0° =1:180°
bit2 : Wave Shape =0: Normal
=1: for Flanger

*15-3-4 : Waveform
EB : T+10
FF : T-10
00 : S-10
14 : S+10

*15-4 : Dynamic Modulation Source
0 : None 7 : Value Slider
1 : Joy Stick (+Y) 8 : V.S + J.S(+Y)
2 : Joy Stick (-Y) 9 : V.S + J.S(-Y)
3 : After Touch A : V.S + A. Touch
4 : Ass Pedal 1 B : V.S + Pedal 1
5 : Ass Pedal 2 C : V.S + Pedal 2
6 : VDA EG D : V.S + VDA EG

PROGRAM PARAMETERS : PAGE/STAGE/POSITION TO OFFSET (TABLE 6)

STAGE	PARAMETER	POSITION								
		A	B	C	D	E	F	G	H	
IN PROGRAM MODE										
PAGE 0		0	1	2	3	4	5	6	7	
0	(FOR EFFECT DYNAMIC MOD)	(POSITION = 0)								
5	(FOR PERFORMANCE EDIT)	OSC	WS	FC	FINT	LEVL	ATK	REL	EFF	
IN EDIT PROGRAM MODE										
PAGE 0 : OSC		0	1	2	3	4	5	6	7	
0	OSC MODE	10								
1	ASSIGN/HOLD	11				11				
2	OSC1 MULTISOUND	12, 13	65			14	40	90		
3	OSC2 MULTISOUND	15, 16	116			17	91	141		
4	OSC2	18			19		20			
5	PITCH EG	21	22	23	24	25	26	28	27	
PAGE 1 : EMPHASIS/WAVE SHAPING		0	1	2	3	4	5	6	7	
1	OSC1 EMPHASIS	87					88			
2	OSC2 EMPHASIS	138					139			
4	OSC1 WAVE SHAPING	82				86	83	84	85	
5	OSC2 WAVE SHAPING	133				137	134	135	136	
PAGE 2 : VDF1		0	1	2	3	4	5	6	7	
0	CUT OFF	50								
1	KEYBOARD TRACKING	52				51		89		
2	EG INTENSITY	53				56				
3	EG TIME VELOCITY SENS	55				79	79	79	79	
4	EG TIME KEYBOARD TRACKING	54				78	78	78	78	
5	ENVELOPE	57	58	59	60	61	62	63	64	
PAGE 3 : VDF 2		0	1	2	3	4	5	6	7	
0	CUTOFF	101								
1	KEYBOARD TRACKING	103				102		140		
2	EG INTENSITY	104				107				
3	EG TIME VELOCITY SENS	106				130	130	130	130	
4	EG TIME KEYBOARD TRACKING	105				129	129	129	129	
5	ENVELOPE	108	109	110	111	112	113	114	115	
PAGE 4 : VDA 1		0	1	2	3	4	5	6	7	
1	VELOCITY SENSITIVITY	68								
2	KEYBOARD TRACKING	67				66		89		
3	EG TIME VELOCITY SENS	70				81	81	81	81	
4	EG TIME KEYBOARD TRACKING	69				80	80	80	80	
5	ENVELOPE	71	72	73	74	75	76	77		
PAGE 5 : VDA 2		0	1	2	3	4	5	6	7	
1	VELOCITY SENSITIVITY	119								
2	KEYBOARD TRACKING	118				117		140		
3	EG TIME VELOCITY SENS	121				132	132	132	132	
4	EG TIME KEYBOARD TRACKING	120				131	131	131	131	
5	ENVELOPE	122	123	124	125	126	127	128		
PAGE 6 : PITCH MODULATION		0	1	2	3	4	5	6	7	
0	PITCH BEND	37								
2	OSC1 PITCH MODULATION	40			42		45	43	44	
3	OSC1 PITCH MODULATION	46			49		47	48	41	
4	OSC2 PITCH MODULATION	91			93		96	94	95	
5	OSC2 PITCH MODULATION	97			100		98	99	92	

PAGE 7 : VDF MODULATION		0	1	2	3	4	5	6	7
0	VDF SWEEP	38				34			
1	AFTER TOUCH TO VDA LEVEL	36							
3	VDF MODULATION	29			30		32	31	
4	VDF MODULATION	29					35	39	29
PAGE 8 : EFFECT		0	1	2	3	4	5	6	7
0	EFFECT1 TYPE	143				151	160		181
1	EFFECT1 PARAMETERS	152-159							
3	EFFECT2 TYPE	144				151	170		171
4	EFFECT2 PARAMETERS	162-169							
5	EFFECT PLACEMENT	151			149		150		

COMBINATION PARAMETERS PAGE/STAGE/POSITION TO OFFSET (TABLE 7)

STAGE	PARAMETER	POSITION							
		A	B	C	D	E	F	G	H

IN COMBINATION MODE

PAGE 0		0	1	2	3	4	5	6	7
0	(FOR EFFECT DYNAMIC MOD)	(POSITION = 0)							
4	(FOR PERF. EDIT PROG NO.)	TIM1	TIM2	TIM3	TIM4	TIM5	TIM6	TIM7	TIM8
5	(FOR PERF. EDIT LEVEL)	TIM1	TIM2	TIM3	TIM4	TIM5	TIM6	TIM7	TIM8

IN EDIT COMBINATION MODE

PAGE 0 : TIMBRE		0	1	2	3	4	5	6	7
2	TIMBRE MODE	50	61	72	83	94	105	116	127
3	MIDI CHANNEL	50	61	72	83	94	105	116	127
4	PROGRAM	40	51	62	73	84	95	106	117
5	VOLUME	41	52	63	74	85	96	107	118
PAGE 1 : TIMBRE		0	1	2	3	4	5	6	7
3	KEY TRANSPOSE	42	53	64	75	86	97	108	119
4	DETUNE	43	54	65	76	87	98	109	120
5	PANPOT	44	55	66	77	88	99	110	121
PAGE 2 : WINDOW		0	1	2	3	4	5	6	7
2	VELOCITY WINDOW TOP	47	58	69	80	91	102	113	124
3	VELOCITY WINDOW BOTTON	48	59	70	81	92	103	114	125
4	KEY WINDOW TOP	45	56	67	78	89	100	111	122
5	KEY WINDOW BOTTON	46	57	68	79	90	101	112	123
PAGE 3 : MIDI FILTER		0	1	2	3	4	5	6	7
2	PROGRAM CHANGE FILTER	49	60	71	82	93	104	115	126
3	CONTROL CHANGE FILTER	49	60	71	82	93	104	115	126
4	DAMPER FILTER	49	60	71	82	93	104	115	126
5	AFTER TOUCH FILTER	49	60	71	82	93	104	115	126
PAGE 8 : EFFECT		0	1	2	3	4	5	6	7
0	EFFECT1 TYPE	11				19	28		29
1	EFFECT1 PARAMETERS	20-27							
3	EFFECT2 TYPE	12				19	38		39
4	EFFECT2 PARAMETERS	30-37							
5	EFFECT PLACEMENT	19			17		18		

DRUMKIT PARAMETERS (TABLE 8)

ppp	PARAMETER
0	INDEX NUMBER
1	INST NUMBER
2	KEY
3	TUNE
4	LEVEL
5	DECAY
6	PAN
7	EXCLUSIVE ASSIGN

Program Change MIDI In (X:Channel)

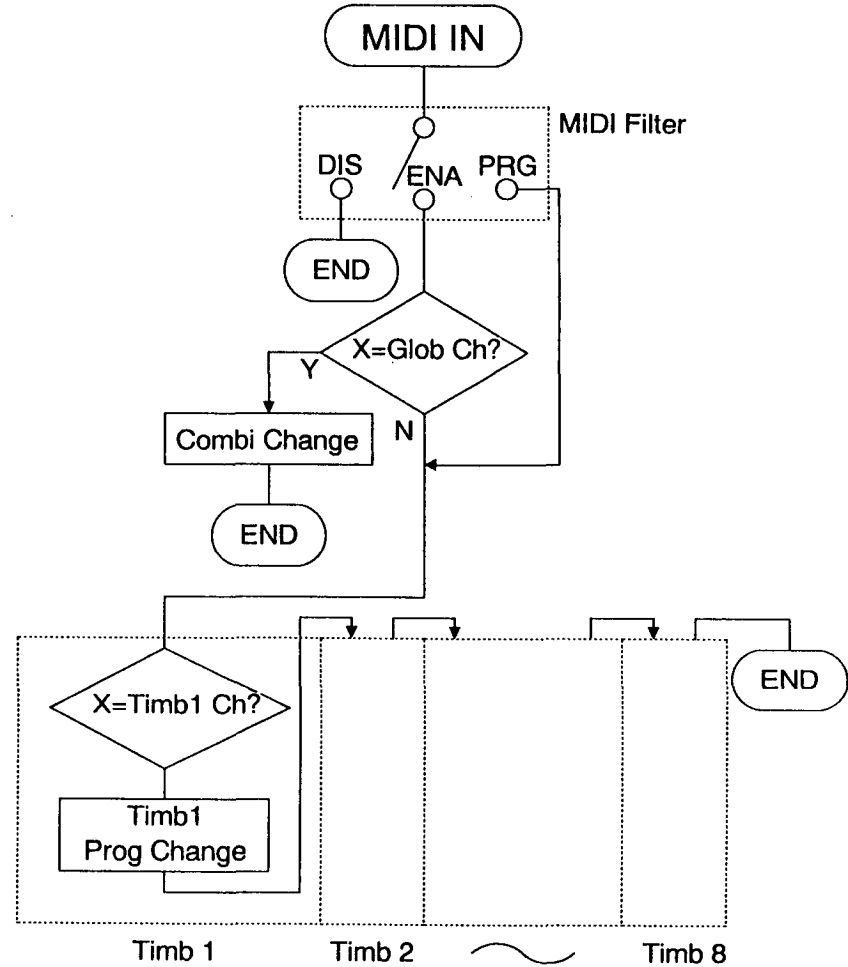

ERROR MESSAGES

Common to all modes

Error message	Meaning
Battery Low (Internal)	The voltage of the internal memory backup battery is low. (Contact your dealer, or a nearby Korg service center.)
Memory Protected	You attempted to write data into memory when the Global mode Protect was set "ON".
Will use New Bank's Drum Kit	You attempted to write data to a bank which differs from the one for the oscillator mode drums program you selected. (Enter a drum kit selected from the same bank used for the write destination.)

Sequencer mode

Error message	Meaning
Beat or Length Mismatch	<p>You attempted to place data (a track or pattern) into a track of a different time signature, or to Bounce/Copy patterns of different lengths.</p> <div style="text-align: center;"> <p style="margin-left: 100px;">Punch In Measure/ Dest Measure</p> <p style="margin-left: 150px;">Track</p> <p style="margin-left: 100px;">Pattern</p> </div>
Blank Measure	Data does not exist in the measure you specified as the source.
Blank Pattern	Data does not exist in the pattern you specified as the source.
Blank Track	Data does not exist in the track you specified as the source.
Card Memory Full	The number of steps in the sequence data you attempted to save exceeds the capacity of the card.
Measure Occupied by Pattern	A pattern overlaps the measure you specified for punch in/out, or the measure you specified as a measure edit destination.
Measure Overflow	The operation you attempted to execute would result in a track length of more than 999 measures.
Memory Full	The total number of steps in all songs and patterns has reached the sequence data memory capacity.
No Events Exist	The track or pattern specified in event edit contains no data.
Pattern Across Source	When copying from a track, the area specified as the source contains part of a pattern. Or, during a Get operation, the specified source area contains all or part of a pattern.
Pattern Conflicts with Events	The attempted Bounce operation cannot be executed, since one track contains a pattern, and the other track contains an event or pattern in the same measure.
Pattern Used in Song	Since the patterns before loading are used in the song, the pattern cannot be loaded.
Source Across Destination	In a Measure Copy (F5-2) operation within the same track, the source and destination data overlap.
Track Protected	The specified track is write-protected.

Disk mode (01/WFD only)

Error message	Meaning
Data Error	The data that was saved to disk or read from disk is incomplete and meaningless. Or, the inserted disk is not for the 01/WFD. Data errors are often caused by scratches or dirt on the disk, and can also occur when a disk is unsuitable for the disk drive, or if the disk drive heads are dirty. If a data error occurs, take the following steps. <ul style="list-style-type: none"> - Re-insert the disk and try the operation again. - If you are formatting or saving, insert a different disk and try again. - Clean the disk drive heads, and try the operation again. (For head cleaning, refer to page 17.)
Disk Type Error	The disk is not formatted for the 01/WFD. Or it is not formatted for Standard MIDI Files.
Drive Not Ready	A disk is not inserted into the drive.
Insufficient Memory	There is not enough free sequence data memory, and MIDI data files cannot be saved or loaded.
Memory Overflow	While saving a MIDI data file, the received data exceeded 64 Kbytes.
No File	The specified file does not exist on the disk.
Protected Disk	The disk's write protect slider is in the write prohibit position, so formatting or saving is not possible.

Global mode

Error message	Meaning
Battery Low (Card)	The voltage of the card memory backup battery is low. (Load the data from the card into internal memory, replace the card battery, and save the data back into the card. When the card battery is replaced, all data in the card will be lost.)
Card Format Mismatch	You attempted to read data which the card did not contain.
Invalid (Unformatted) Card	The card contains no data, or is not intended for the 01/WFD•01/W.
No Card Inserted	You attempted to read or write card data when no card was inserted.
ROM Card or Protected Card	You attempted to write data into a ROM card or a RAM card whose protect switch was ON.
Combi/Prog in the Bank (C/D)	You attempted to load Sequence data from a bank which contained Combination and Program data
SEQ in the Bank (C/D)	You attempted to load Combination, Program or Drum Kit data from a bank which contained Sequence data.
Invalid Bank (C/D)	You attempted to load data from a bank which did not contain any data.

SPECIFICATIONS AND OPTIONS

Tone generation method	AI square synthesis system (full digital processing)
Tone generator	32 voices, 32 oscillators (single mode); 16 voices, 32 oscillators (double mode)
Keyboard	61 notes, with initial and aftertouch sensitivity
Waveform memory	PCM 48 Mbits
Effects	two digital multi-effect systems
Programs	200 Programs
Combinations	200 Combinations
Sequencer section	10 Songs, 100 Patterns, maximum 48,000 notes (for the 01/W, 7,000), 16 tracks, 16 timbres (dynamic voice allocation)
Control inputs	Damper pedal, Assignable pedal 1, 2
Outputs	1/L, 2/R, 3, 4, headphones
Floppy disk drive (01/WFD only)	3.5 inch 2DD (for Program/Combination/Drum Kit/Global parameters/Sequence data/MIDI data)
PCM card slot	PCM data
PROG/SEQ card slot	for Program/Combination/Drum Kit/Global parameters / Sequence data
MIDI	IN, OUT, THRU
Display	LCD 64 x 240 dots, full dot matrix, with backlight
Options	RAM card (SRC-512), ROM card, PCM card
Power consumption	20 W
Dimensions	1059.5 (W) x 344 (D) x 115.5 (H)
Weight	01/WFD.....13.9 kg 01/W.....13.4 kg

* Appearance and specifications are subject to change without notice for product improvement.

TROUBLESHOOTING

The LCD does not light when the POWER switch is turned on	<ul style="list-style-type: none"> - Is the power cable plugged in? - Is the Global mode Contrast control correctly adjusted?
No sound	<ul style="list-style-type: none"> - Are the amplifier or headphones connected to the correct jack? - Has the master volume been turned up? - Are any of the level-related parameters set to 0? - Is the Global mode MIDI Global parameter Local OFF? - Are you playing an area of the keyboard which will not sound due to split settings or the pitch range?
Cannot format a disk	<ul style="list-style-type: none"> - Is the write protect tab of the disk in the write prohibit (open) position? - Is the disk inserted correctly?
Cannot save data to disk	<ul style="list-style-type: none"> - Is the write protect tab of the disk in the write prohibit (open) position? - Is the disk inserted correctly? - Is the disk a correctly formatted good-quality 2DD type disk?
Cannot load data from disk	<ul style="list-style-type: none"> - Is the disk inserted correctly? - Does the disk contain data?
Cannot save data to card	<ul style="list-style-type: none"> - Is the card protect switch ON? - Is the card a ROM card? - Is the card inserted correctly?
Cannot load data from card	<ul style="list-style-type: none"> - Is the card inserted correctly? - Does the card contain data?
The sound is not correct	<ul style="list-style-type: none"> - Is the inserted PCM data card the one you used when creating the sound? - Is the inserted PROG data card the one you used when creating the Combination? - Is the drum kit taken from the same bank you used for the Program when creating the drum program?
The sequencer will not start	<ul style="list-style-type: none"> - Is the clock source set to EXT? - Is there data?
Cannot record into the sequencer	<ul style="list-style-type: none"> - Is memory protect or track protect turned on?
The sound does not stop	<ul style="list-style-type: none"> - Is the damper polarity correct? - Is the program parameter hold turned "ON" ?
Cannot control through MIDI	<ul style="list-style-type: none"> - Are the MIDI cables connected correctly? - Is the MIDI channel correct? - Is the Filtering in the Global mode set to "DIS" ?

01/W MEMORY CONFIGURATION

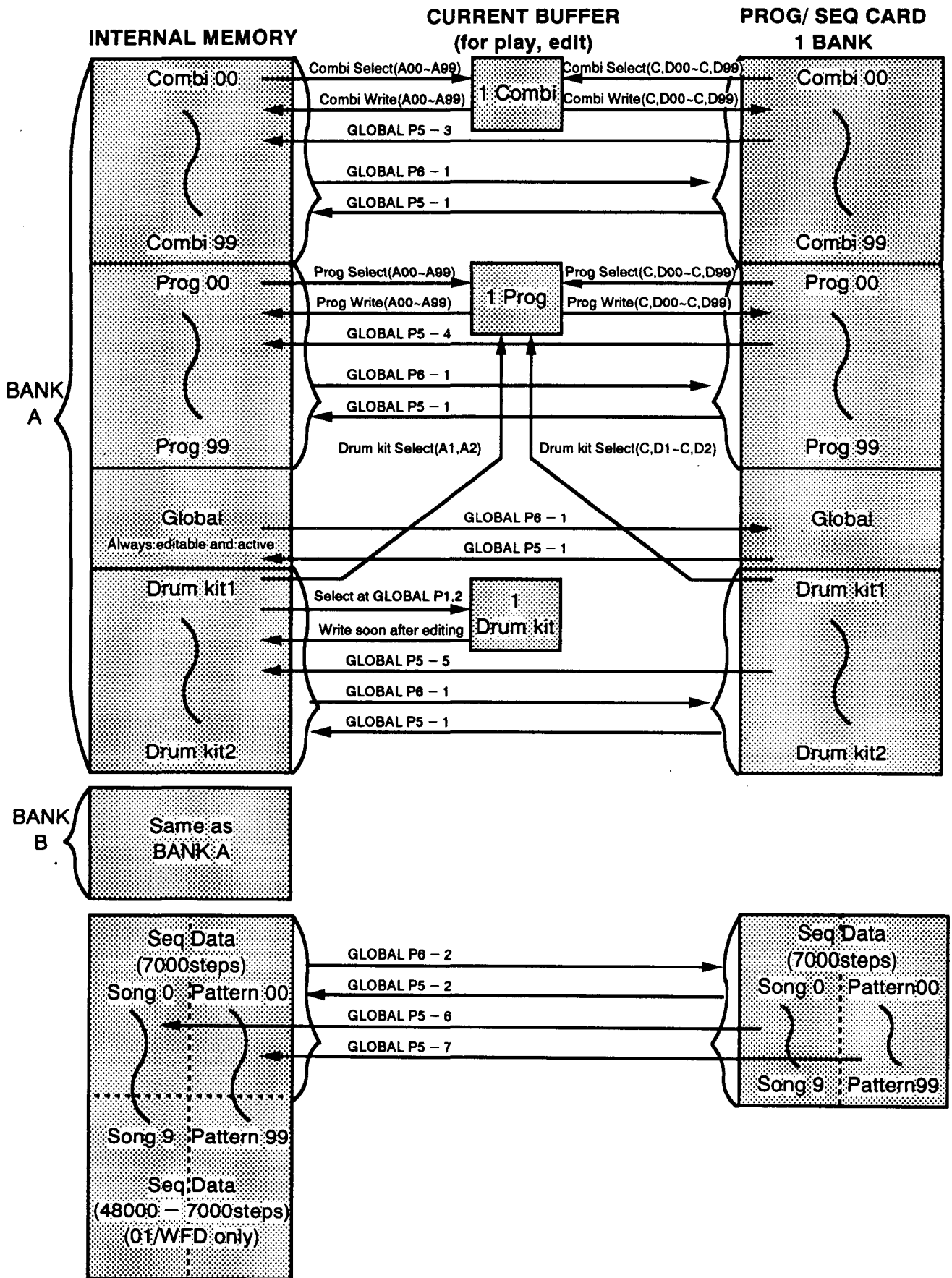

01/WFD, 01/W MIDI Implementation Chart

01/WFD, 01/W MIDI Implementation Chart

Function ...		Transmitted	Recognized	Remarks
Basic Channel	Default Changed	1 ~16 1 ~16	1 ~16 1 ~16	Memorized
Mode	Default Messages Altered	× *****	3 ×	
Note Number:	True voice	24~108 *****	0 ~127 0 ~127	Seq. Data : 0~127
Velocity	Note ON Note OFF	○ 9n, V= 1 ~127 ×	○ 9n, V= 1 ~127 ×	Seq. Data : 2~126
After Touch	Key's Ch's	○ ○	○ ○	Key's : Sequence *5, 6 Data only *5
Pitch Bender		○	○	*1
Control	0, 32	○	○	Bank (MSB),(LSB) *3
	1, 2	○	○	Mod Wheel *1
Change	6, 38	○	○	Data Entry (MSB),(LSB) *2
	7	○	○	Volume *1
	10	○	○	Pan Pot *1
	11	×	○	Expression *1
	12, 13	○	○	FX 1,2 Cntrl *1
	64	○	○	Damper *1
	91, 92	○	○	FX 1,2 ON/OFF *1
	96, 97	○	○	Data Increment/Decrement *2
	100, 100~102	×	○	RPC (LSB,MSB) *2
	121	×	○	Reset All Cntrls
0~101	○	○	(Sequence Data) *6	
Prog Change: True #	○ 0 ~99 *****	○ 0 ~127 0 ~99	*3	
System Exclusive	○	○	*2	
System Common:	Song Pos	○	○	*4
	Song Sel	○ 0 ~29	○ 0 ~29	*4
	Tune	×	×	
System Real Time:	Clock	○	○	*4
	Commands	○	○	*4
Aux Messages :	Local ON/OFF	×	○	
	: All Notes OFF	×	○ 123~127	
	: Active Sense	○	○	
	: Reset	×	×	
Notes *1 Transmitted and recognized when CONTROL=ENA in global mode. *2 Transmitted and recognized when EXCLUSIVE=ENA in global mode. *3 Transmitted and recognized when PROG CHANGE=ENA in global mode. *4 Transmitted but not recognized when using Internal Clock. Recognized but not transmitted when using External Clock. *5 Transmitted and recognized when AFTER TOUCH=ENA in global mode.				*6 Only Sequence Data will be transmitted and recognized.

Mode 1 : OMNI ON, POLY
Mode 2 : OMNI ON, MONO

Mode 3 : OMNI OFF, POLY
Mode 4 : OMNI OFF, MONO

○ : Yes
× : No

WAVE SHAPING LIST

00 Sine	10 Symmetry	20 Take 1	30 Take 2	40 Integers	50 7th Res.
01 2 Cycle	11 Frequency8	21 Vitalsings	31 Take 3	41 Super Sqr	51 Waves
02 Frequency3	12 Resonant 1	22 Forest	32 Take 4	42 LineSine 2	52 Take 6
03 Frequency7	13 Resonant 2	23 Zigzag	33 Take 5	43 Comb	53 Exciter
04 10 Cycle	14 Zinger	24 High Pass	34 Experiment	44 Snake	54 Booster
05 Cocoon	15 GeoGraphic	25 LineSine 1	35 Real Steep	45 Rezzo	55 Claver
06 DoubleSine	16 Reptile	26 WS Bass	36 Pulse 5	46 Super Res.	56 Soft Road
07 Phase	17 SyncSter	27 Soft Curve	37 BowwBass	47 Acordion	57 Rubber
08 20 Cycle	18 Profile	28 Smoothy	38 Pulse Oct.	48 Triangles	58 Parabola
09 Attack Up	19 Star	29 LogSine 1	39 Inverter 1	49 Inverter 2	59 Wurlly

DRUM SOUND

000 Fat Kick	017 Ambi.Snare	034 CloseSynHH	051 Mute Conga	068 Zap 2	085 MetalBell1	102 Tri Roll
001 Rock Kick	018 Rev Snare	035 Open SynHH	052 Maracas	069 Stick Hit	086 MetalBell2	103 Yo vox
002 Ambi.Kick	019 RollSnare1	036 Ride Edge	053 L- Shaker	070 Scratch Hi	087 Gamelan 1	104 Flutter
003 Crisp Kick	020 RollSnare2	037 Ride Cup	054 S- Shaker	071 Scratch Lo	088 Gamelan 2	105 Timpani
004 Punch Kick	021 Rock Snare	038 Tom	055 Cabasa	072 ScratchDbl	089 Pole	106 Orch Crash
005 Real Kick	022 GatedSnare	039 ProcessTom	056 MuteTriang	073 Castanet	090 TubulBel 1	107 Music Box1
006 Dance Kick	023 HouseSnare	040 Syn Tom 1	057 OpenTriang	074 FingerSnap	091 TubulBel 2	108 Music Box2
007 Gated Kick	024 Syn Snare1	041 Syn Tom 2	058 Tambourine	075 Industry	092 Gong	109 Tron Up
008 ProcesKick	025 Syn Snare2	042 Agogo	059 Cowbell	076 Rev Thing	093 Wind Gong	110 Clicker 1
009 Metal Kick	026 Fist	043 Lo Bongo	060 R- Timbal	077 Kalimba	094 Alia Bass	111 Clicker 2
010 Syn Kick 1	027 Side Stick	044 Hi Bongo	061 Hi Timbal	078 Marimba 1	095 Spectrum 1	112 Clicker 3
011 Syn Kick 2	028 Syn Rim	045 Slap Bongo	062 Lo Timbal	079 Marimba 2	096 Spectrum2a	113 Crickets
012 Snare 1	029 CrshCymbal	046 Claves	063 WoodBlockH	080 Marimba 3	097 Spectrum2b	114 Crash 2
013 Snare 2	030 Tite HH	047 Syn Claves	064 WoodBlockM	081 Log Drum 1	098 Noise	115 Orch Hit
014 PicloSnare	031 Close HH	048 Open Conga	065 WoodBlockL	082 Log Drum 2	099 Stadium	116 Wind Bell
015 Soft Snare	032 Open HH	049 Slap Conga	066 Hand Claps	083 Digi.Bell	100 Thing	117 Metronome1
016 TightSnare	033 Pedal HH	050 Palm Conga	067 Zap 1	084 BrightBell	101 Belltree	118 Metronome2