

A V I S T A ⁷⁶⁰⁰

User's Guide



ENSONIQ

READ THIS FIRST!

WARNING!!

To reduce the risk of fire or electric shock, do not expose this product to rain or moisture.

Grounding Instructions

This product must be grounded. If it should malfunction or break down, grounding provides a path of least resistance for electric current to reduce the risk of electric shock. This product is equipped with a cord having an equipment-grounding conductor and a grounding plug. The plug must be plugged into an appropriate outlet that is properly installed and grounded in accordance with all local codes and ordinances.

DANGER: Improper connection of the equipment-grounding conductor can result in the risk of electric shock. Check with a qualified electrician or service personnel if you are in doubt as to whether the product is properly grounded. Do not modify the plug provided with this product — if it will not fit the outlet, have a proper outlet installed by a qualified electrician.

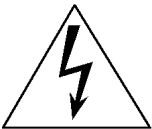
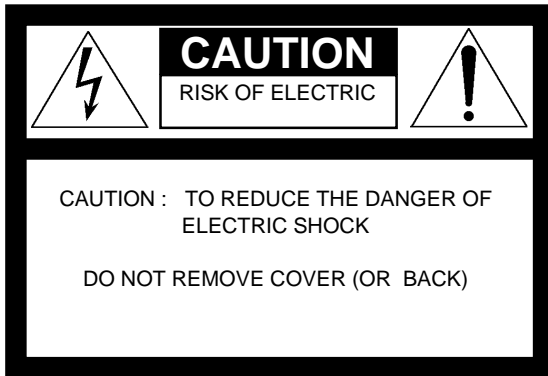

This symbol is intended to alert the user to the presence of uninsulated "dangerous voltage" within the product's enclosure that may be of sufficient magnitude to constitute a risk of electronic shock to persons.



This symbol is intended to alert the user to the presence of important operating and maintenance (servicing) instructions in the literature accompanying the appliance.

**“INSTRUCTIONS PERTAINING TO A RISK OF FIRE,
ELECTRIC SHOCK, OR INJURY TO PERSONS”**

IMPORTANT SAFETY INSTRUCTIONS

WARNING—When using electric products, basic precautions should always be followed and all warnings heeded, including the following:

1. Read and follow all enclosed instructions before using the product.
2. Do not use this product near water - for example, near a bathtub, washbowl, kitchen sink, in a wet basement, or near a swimming pool, or the like.
3. Product should be used only with a cart or stand recommended by the manufacturer.
4. This product, either alone or in combination with an amplifier and headphones or speakers, may be capable of producing sound levels that could cause permanent hearing loss. Do not operate for a long period of time at a high volume level or at a level that is uncomfortable. If you experience any hearing loss or ringing in the ears, you should consult an audiologist.
5. The product should be located so that its ventilation openings are not blocked.
6. The product should be located away from heat sources such as radiators, heat registers, or other products that produce heat.
7. The product should be connected to a power supply only of the type described in the operating instructions or as marked on the product.
8. This product may be equipped with a polarized line plug (one blade wider than the other) or grounding-type plug (two blades and a third grounding prong). If you are unable to insert the plug into the outlet, contact an electrician to replace your obsolete outlet. The wide blade and third prong are provided for your safety—do not defeat the safety purpose of the polarized or grounding-type plug.
9. Unplug this product during lightning storms or when unused for a long period of time.
10. Care should be taken so that objects do not fall and liquids are not spilled into the enclosure through openings.
11. The product should be serviced by qualified service personnel when:
 - a. The power supply cord or the plug has been damaged; or
 - b. Objects have fallen, or liquid has been spilled into the product; or
 - c. The product has been exposed to rain or moisture; or
 - d. The product does not appear to operate normally or exhibits a marked change in performance; or
 - e. The product has been dropped, or the enclosure damaged.
12. Do not attempt to service the product beyond that described in the user-maintenance instructions. All other servicing should be referred to qualified service personnel.
13. Clean product only with a damp cloth.
14. Protect the power cord from being walked on or pinched, particularly at plugs, convenience receptacles, and the point where they exit from the product.
15. Only use the attachments/accessories specified by the manufacturer.

SAVE THESE INSTRUCTIONS

Avista 7600 User's Guide

Copyright © 1998
EMU-ENSONIQ® Corp
155 Great Valley Parkway
Box 3035
Malvern, PA 19355-0735
USA
World Wide Web <http://www.ensoniq.com>

Printed in U.S.A.

All Rights Reserved

Your Authorized ENSONIQ Dealer is your primary source for service and support. If you have any questions concerning the use of this unit, please contact your Authorized ENSONIQ Dealer first. For additional technical support, or to find the name of the nearest Authorized ENSONIQ Repair Station, call ENSONIQ Customer Service.

This manual is copyrighted and all rights are reserved by EMU-ENSONIQ Corp. This document may not, in whole or in part, be copied, photocopied, reproduced, translated, or reduced to any electronic medium or machine readable form without prior written consent from EMU-ENSONIQ Corp. The Avista 7600 software is copyrighted and all rights are reserved by EMU-ENSONIQ Corp.

Although every effort has been made to ensure the accuracy of the text and illustrations in this manual, no guarantee is made or implied in this regard.

ENSONIQ and Avista 7600 are trademarks of EMU-ENSONIQ Corp.

TABLE OF CONTENTS

Welcome to the Avista 7600	1
The Main Features of the Avista 7600	1
About this User's Guide	1
Included Accessories	2
Setting Up the Avista 7600	2
Getting Ready	2
Contents of the Stand Box	2
Contents of the Hardware Bag	2
Required Tools	2
Avista 7600 Stand Assembly Instructions	3
Rear-Panel Connections	4
DC 15V In (Power)	4
Stereo Out	4
Foot Pedal Jacks	4
MIDI Jacks	5
Contrast	5
Turning the Avista 7600 On and Off	6
Listening to the Avista 7600	6
Volume Control	6
The Avista Controls and Display	7
The Minus and Plus Buttons	7
The Display	7
Selecting Preset Sounds	8
Selecting Other Sounds	8
Playing the Avista 7600 Demos	8
Selecting Sounds	8
The Avista 7600's General MIDI Sounds	9
The Avista 7600's General MIDI Drum/Percussion Kits	10
Adjusting a Sound's Volume	10
Layering Two Sounds	10
Adjusting the Volume of a Layer	10
The Master Controls Section	11
Transposing the Notes You Play	11
Adjusting the Response of the Keyboard	11
Using the Avista's Metronome	12
Setting the Metronome's Time Signature	12
Activating the Metronome	12
Adjusting the Metronome Tempo	12
Adding Effects to a Sound	13
To Turn the Reverb or Chorus Effects On	13
To Adjust the Volume of an Effect	13
Recording Music in the Avista 7600	14
The Rec/Play Controls	14
Making a Recording	15

To Play Back a Recording	15
Using the Other Recorder Controls	15
Playing a Specific Portion of Your Recording	15
To Make a New Recording	15
To Change a Recording's Tempo	16
To Re-Orchestrate a Recording	16
Using the Avista Floppy Drive	16
The Disk Controls	16
The Floppy Drive	17
Working with Floppy Disks	17
Write-Protection	17
Formatting a Floppy Disk for Use	18
Saving Your Recordings to Disk	18
Updating and Over-Writing Disk Files	19
Loading Recordings from Disk	20
Muting an SMF Recording's Melody	20
The Avista 7600 and MIDI	21
Transmitting MIDI from the Avista 7600	21
To Select the Channel on Which the Avista Transmits MIDI Data	21
Receiving MIDI Data on the Avista 7600	22
Muting a MIDI Channel	22
Viewing the Sounds Played on Each MIDI Channel	22
Proper Operation of the Avista 7600	23
Temperature Guidelines	23
Care and Feeding of the Disk Drive	23
Clean-Up and Maintenance	24
Polarization and Grounding	24
AC Line Conditioning	25

WELCOME TO THE AVISTA 7600

Congratulations on your purchase of the ENSONIQ Avista 7600. We're confident that you'll experience many hours of pleasure with this elegant, easy to use and great-sounding keyboard.

The Main Features of the Avista 7600

- Your Avista 7600 contains 136 terrific sounds that you can play using its realistic piano-style keyboard. You can listen to these sounds through the Avista's built-in speakers, your headphones, or you can connect the Avista's stereo output to the inputs of a home stereo amplifier or audio recorder.
- You can play two sounds at once, layered on top of each other.
- You can instantly transpose your playing into any key with a tap or two of the Avista's Transpose button.
- You can add reverb and/or chorusing effects to the Avista's sounds, making them sound even more exciting.
- You can record your playing into the Avista's built-in recorder—and then hear it instantly played back. Once recorded, you can store your music on a floppy disk using the Avista's built-in floppy drive. You can load your music back into the Avista's recorder at any time; you can even load your recording into your home computer with the proper software installed.
- You can play any General MIDI (GM) recording once you've loaded it into your Avista from a floppy disk. There are thousands of GM recordings available for purchase from your local music store, or downloadable—often for free—from the Internet. When playing a GM recording, you can mute the melody part, allowing you to sing or play the melody yourself.
- If you've got a computer or other external MIDI sequencer, you can play the Avista's sounds via MIDI.

About this User's Guide

Throughout this booklet, you'll see special pieces of information presented as notes, tips and warnings.

- Notes provide important qualifying information relating to the topic being discussed.
- Tips describe handy uses for the feature being described.
- Warnings contain important information that can help you avoid damage to your music, the Avista or yourself.

Included Accessories

- music stand
- power adapter
- warranty card
- foot pedal
- Avista 7600 User's Guide
- power adapter line cord

SETTING UP THE AVISTA 7600

Getting Ready

Prior to assembling the Avista 7600's stand, make sure that you have all of the necessary parts and tools.

Contents of the Stand Box

- 2 stand legs (left and right)
- 2 metal brackets
- Center support board
- hardware bag

Contents of the Hardware Bag

- Four M6 x 30 screws
- Four M5 x 30 screws
- Four plated thumbscrews
- Eight screw-hole covers

Required Tools

You'll need a #2 (medium) Philips-head screwdriver.

Avista 7600 Stand Assembly Instructions

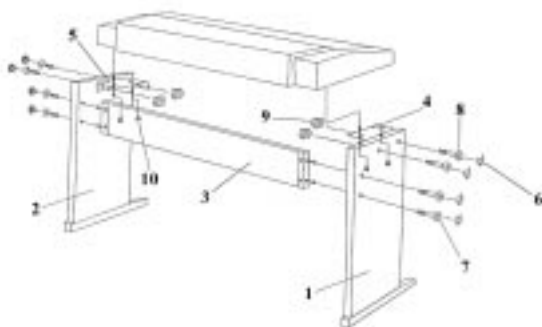

1. Using the four larger screws (8), connect a bracket (4 and 5) to the inside of each leg (1 and 2) so that its lip is facing toward the foot side of the leg. Each bracket has two circular holes on one of its sides, and two oval-shaped holes on its other side. When attaching a bracket to a leg, align the two circular holes with the two bracket holes on the leg. Insert each screw from the outside of the leg and fasten it on the inside of the bracket using a nut (9).

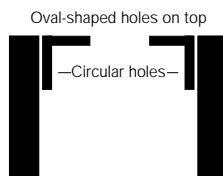

Oval-shaped holes on top
—Circular holes—
When each leg is viewed from its front edge, the brackets should look like this

2. Taking care not to crack the center support board (3), use the smaller screws (7) to attach it to the inside of one of the legs and then the other.

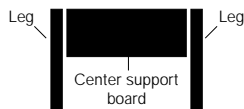

3. Set the stand upright and place the Avista on top of the stand so that its keyboard is facing the leg feet.
4. From underneath, use the plated thumbscrews (10) to attach the keyboard to the oval-shaped holes in the brackets. You may have to slightly re-position the keyboard so that its holes line up with the holes in the brackets.
5. Snap each of the four screw hole covers (6) into a hole on the outside of each stand leg to cover the head of the screw mounted in the hole.
6. Insert the music stand into the slots in the top of the Avista 7600.

REAR-PANEL CONNECTIONS



Note: The rear-panel jacks are also labeled on top of the Avista so that they can be easily located from the front.

DC 15V In (Power)

To supply power to the Avista, connect the small end of the supplied power adapter to the Avista’s DC 15V In jack. Connect one end of the supplied line cord to the adapter, and the other end to a 110-volt grounded wall outlet.

Warning: See “Polarization and Grounding” on Page 24.

Stereo Out

The Stereo Output jack allows you to send the Avista’s high-quality stereo sound output to any pair of line-level inputs such as those found on a home stereo system amplifier, cassette recorder or mixer. The jack is intended for use with a “Y” cable that has a stereo 1/4” plug on one end—the end that connects to the Avista’s jack—and a pair of mono plugs (RCA-type or 1/4”) at the other end. These cables can be purchased at most audio/TV supply stores.

Warning: When connecting the Avista to a home stereo, set the stereo’s volume carefully to avoid damaging your speakers.

Note: The volume of the Stereo Out jack is set at a fixed line level, and is unaffected by the setting of the Avista’s Volume slider.

Note: Connecting a cable to the Stereo Output jack does not turn off the Avista’s built-in speakers.

Foot Pedal Jacks

- **Damper**—When a foot switch—such as the supplied foot pedal—is connected to the Avista’s Damper jack, the pedal acts in the same manner as a sustain pedal on a piano.
- **Soft**—When the foot pedal is connected to the Avista’s Soft jack, the pedal acts in the same manner as a soft pedal on a piano.

Tip: The Avista 7600 ships with one foot pedal. You can purchase a second pedal by calling ENSONIQ Customer Service at 610-647-3930.

MIDI Jacks

If you intend to connect the Avista to an external MIDI device, you'll need to attach one or more MIDI cables—purchased separately—to the Avista's MIDI jacks. MIDI and MIDI operations are described on Page 21.

- **In**—To transmit MIDI data from an external device into the Avista, connect one end of a MIDI cable to the device's MIDI Out jack and the other end to this jack.
- **Out**—To transmit MIDI data from the Avista to an external device, connect one end of a MIDI cable to this jack and the other end to the external device's MIDI In jack.
- **Thru**—When you're interconnecting a series of MIDI devices and want to pass MIDI information from one device to the next, connect a MIDI cable between one device's MIDI Thru jack and the MIDI In jack of the next device in the daisychain.

Contrast

The Contrast knob allows you to set the contrast of the Avista's display so that its characters are easily readable from any viewing angle. To adjust the contrast, seat yourself in your intended playing position and turn the knob clockwise and /or counter-clockwise to achieve maximum display legibility.

TURNING THE AVISTA 7600 ON AND OFF

To turn the Avista 7600 on, press the front-panel Power button—the display will light and show “Welcome!” To turn it off, press the button again.



LISTENING TO THE AVISTA 7600

You can listen to the Avista 7600 through its built-in speakers or by plugging standard stereo headphones into either of the 1/4" stereo headphone jacks—labeled “Phones1” and “Phones2”—located below and just to the left of the lowest key on the keyboard.

Note: When headphones are connected to either Phones jack, the Avista’s speakers are turned off so that you can listen privately.

Note: If your headphones have a stereo mini-plug, you can purchase a stereo mini-to-stereo 1/4" adapter at many audio supply stores.

Volume Control

To set the Avista 7600’s overall listening level, adjust the position of its Volume slider.

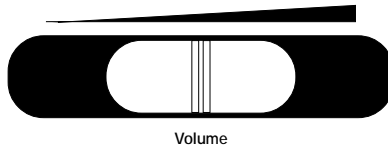

Tip: You can also adjust the volume of each sound. See Page 10.

THE AVISTA CONTROLS AND DISPLAY

The Avista's front panel is divided into five sections, each of which controls a certain type of activity. These are all described in this User's Guide.

- The master controls section allows you to set the sensitivity of its keyboard, transpose your playing and activate and adjust the built-in metronome.
- The eight sound buttons under the display allow you to quickly select and layer sounds.
- The Reverb/Chorus section allows you to select and adjust effects that can be added to the Avista's sounds, and contain the very important minus and plus buttons (described below).
- The buttons in the Disk-Rec/Play section serve a dual purpose. When the Disk-Rec/Play button's LED is lit, these buttons control the Avista's floppy disk operations. When the LED is unlit, these buttons control the Avista's built-in recorder.

The Minus and Plus Buttons

The minus and plus buttons located above the Reverb and Chorus buttons play a part in many of the things you'll do with the Avista 7600.



Whenever you're selecting a sound from the list of the Avista's sounds, or editing some displayed value, you can select the next lowest item—or value—by clicking the minus button, and the next highest by clicking the plus button.

The Display

The Avista's display is the window through which you view the settings associated with its many features. Whatever you do, information relevant to the task at hand appears on the display.



Tip: You can change the readability of the display by adjusting its contrast. See Page 5.

PLAYING THE AVISTA 7600 DEMOS

The Avista contains three pre-recorded demonstration songs—or “demos”—to give you an idea of its capabilities.



- To listen to all three demos, press the blue Demo button.
- To stop the demo, press the button again.
- To select and play one of the demos, hold down the Demo button and press the plus or minus button to select the desired demo.

SELECTING SOUNDS

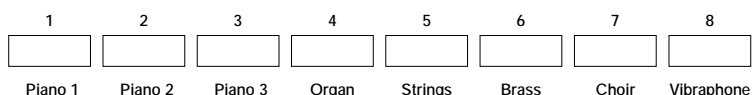

Selecting Preset Sounds

Before you can play one of the Avista’s sounds, you must first select the sound. Each of the eight buttons beneath the display is pre-set to select one of eight commonly-used sounds.

<i>Button</i>	<i>Selects</i>	<i>Button</i>	<i>Selects</i>
1	Grand Piano 001	5	Strs Ensemble 049
2	Bright Piano 002	6	Brass 062
3	Chorused Piano 006	7	Choir Aahs 053
4	Church Organ 020	8	Vibraphone 012

To select one of the eight preset sounds, press its button.

Selecting Other Sounds

In GM mode, you can select any of the other onboard sounds:

1. Press the blue GM button so that its LED lights.
2. Press the desired sound button.
3. Press the minus or plus button to select the desired sound.



Tip: Hold down the minus or plus button to quickly scroll down or up, respectively, through the list of sounds.

All of the Avista’s sounds except its drum kits are numbered to show their place in the GM sound list.

The sound you choose will be assigned to the sound button you pressed until you exit GM mode (or turn off the Avista). To reset the button to its original sound, press the GM button again to exit GM mode.

The Avista 7600's General MIDI Sounds

Grand Piano	001	Contrabass	044	Lead 7	087
Bright Pno	002	Tremolo Strs	045	Lead 8	088
E.Grand Pno	003	Pizz Strings	046	Pad 1	089
Honky-T Pno	004	Orch Harp	047	Pad 2	090
Elec. Pno	005	Timpani	048	Pad 3	091
Chorused Pno	006	Strs Ensemb1	049	Pad 4	092
Harpischord	007	Strs Ensemb2	050	Pad 5	093
Clavinet	008	Syn String1	051	Pad 6	094
Celesta	009	Syn String2	052	Pad 7	095
Glockenspiel	010	Choir Aahs	053	Pad 8	096
Music Box	011	Voice Oohs	054	FX 1	097
Vibraphone	012	Syn Voice	055	FX 2	098
Marimba	013	Orch Hit	056	FX 3	099
Xylophone	014	Trumpet	057	FX 4	100
Tubular Bell	015	Trombone	058	FX 5	101
Dulcimer	016	Tuba	059	FX 6	102
Hammond Organ	017	Muted Trumpet	060	FX 7	103
Percus Organ	018	French Horn	061	FX 8	104
Rock Organ	019	Brass	062	Sitar	105
Church Organ	020	Syn Brass1	063	Banjo	106
Reed Organ	021	Syn Brass2	064	Shamisen	107
Accordion	022	Soprano Sax	065	Koto	108
Harmonica	023	Alto Sax	066	Kalimba	109
Tango Accdn	024	Tenor Sax	067	Bagpipe	110
Nylon Guitar	025	Baritone Sax	068	Fiddle	111
Steel Guitar	026	Oboe	069	Shanai	112
Jazz Guitar	027	English Horn	070	Tinkle Bell	113
Clean Guitar	028	Bassoon	071	Agogo	114
Muted Guitar	029	Clarinet	072	Steel Drums	115
Overdrv Gtr	030	Piccolo	073	Woodblock	116
Distort Gtr	031	Flute	074	Taiko Drum	117
Guitar Harm	032	Recorder	075	Melodic Tom	118
Acoust Bass	033	Pan Flute	076	Synth Drum	119
Finger Bass	034	Bottle Blow	077	Rvrse Cymbal	120
Pick Bass	035	Shakuhachi	078	Fret Noise	121
Fretless Bas	036	Whistle	079	Breath Noise	122
Slap Bass1	037	Ocarina	080	Seashore	123
Slap Bass2	038	Lead 1	081	Bird Tweet	124
Synth Bass1	039	Lead 2	082	Telephone	125
Synth Bass2	040	Lead 3	083	Helicopter	126
Violin	041	Lead 4	084	Applause	127
Viola	042	Lead 5	085	Gun Shot	128
Cello	043	Lead 6	086		

The Avista 7600's General MIDI Drum/Percussion Kits

In addition to the 128 sounds listed on the preceding page, the Avista 7600 contains a set of General MIDI drum kits. Unlike normal GM sounds, in which a single sound plays up and down the keyboard, in a GM drum kit, each key plays its own sound. While the keyboard placement of individual drum or percussion sounds is consistent from kit to kit, each General MIDI kit has its own musical personality. The kits are:

Standard Kit	Room Kit	Power Kit	Electronic Kit
TR-808 Kit	Jazz Kit	Brush Kit	Orchestra Kit

Adjusting a Sound's Volume

You can adjust the volume of any selected sound without affecting the Avista's overall volume. To do this:

1. Hold down the sound's button until "Volume=[the current volume setting]" appears.
2. Press the minus or plus button to set the volume as desired.

Layering Two Sounds

You can layer two sounds so that when you play a key on the keyboard, both sounds are heard. This can be done using the eight preset sounds or sounds you've temporarily assigned to the sound buttons (see "Selecting Other Sounds" on Page 8). To layer two sounds:

1. Press and hold down the sound button for the first sound you want to use. This sound is called the "primary sound."
2. While still holding down the first sound's button, press the button for the second sound you want to use—this sound is called the "layer." The display will show the number of the primary sound and the layer sound joined by a "+" sign.
3. When the numbers of the two sounds appear, release both buttons.

Adjusting the Volume of a Layer

To adjust the volume of the layer sound:

1. Press and hold down the button for the primary sound.
2. While still holding down the primary sound's button, press and hold the button for the layer sound until "LAYER VOL=[the current layer volume setting]" appears.
3. Press the minus or plus button to set the volume as desired.

THE MASTER CONTROLS SECTION

Using the buttons in the master controls section of the Avista 7600's front panel, you can transpose your playing, change the response of the Avista's keyboard, and set and activate the built-in metronome.

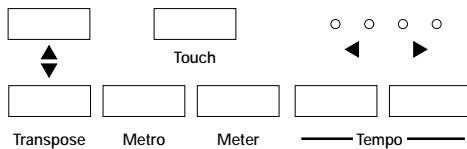

Transposing the Notes You Play

The Avista 7600 can transpose your playing up or down by as much as an octave in semitone steps. This allows you to play in whatever key you find comfortable—the Avista will shift the notes to the desired key for you. This is accomplished using the Transpose buttons. The Avista's display shows the amount of transposition in effect.

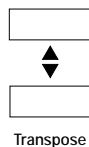

- To transpose your notes upward, repeatedly press the upper Transpose button until the number of semitones by which you want to raise your key is displayed.
- To transpose downward, press the lower Transpose button until the number of semitones by which you want to lower your key is displayed. A minus sign will be shown before the displayed number to show that you're below concert pitch.

Tip: To return to concert pitch, press both Transpose buttons at the same time—the display will show "00" when no transposition is in effect.

Adjusting the Response of the Keyboard

The manner in which the Avista's touch-sensitive keyboard plays its sounds can be adjusted to suit the amount of force with which you like to play. This allows you to play comfortably and still get the most out of the Avista's sounds. The best way to find the setting that's right for you is to experiment by spending some time with each one. Press the Touch button repeatedly to select any of the four settings.



- **Soft**—This setting is designed for players who use a minimum amount of force.
- **Medium**—This average setting will suit most users.

- **Hard**—Use this setting if you like to pound the keys.
- **Fixed**—This setting turns off the touch sensitivity of the Avista’s keyboard so that, regardless how hard you play, the sounds will respond as if you’ve hit the keys with maximum force. This can be handy when recording drum sounds, since it will produce a recording without any volume fluctuations.

Using the Avista’s Metronome

The Avista provides a built-in metronome as a rhythmic reference for your playing. This can be handy when practicing. The metronome can also be heard when you record in the Avista, though the metronome’s sound is not itself recorded.

Setting the Metronome’s Time Signature

The Avista’s metronome can be set to any of seven meters:

2/4	4/4	6/8	12/8
3/4	5/8	9/8	

To select a meter, repeatedly press the Meter button



Activating the Metronome

To turn the metronome on, click the Metro—for “metronome”—button. To turn it off, press the button again.



As the metronome plays, the four LEDs above the Tempo buttons light to show your place in each measure. At the first beat of each measure, all four LEDs light simultaneously.

Adjusting the Metronome Tempo

The metronome can be set to play at any tempo from 40 beats per minute to 240 beats per minute. The tempo can be changed when the metronome is turned off, or when it’s on—when you change the tempo while the metronome is on, you hear the changes you make and see the rate at which the LEDs blink change as well.

- To slow down the metronome, press the left-hand Tempo button until the desired tempo is displayed and/or heard.
- To speed up the metronome, press the right-hand Tempo button.

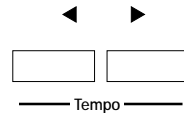

ADDING EFFECTS TO A SOUND

The Avista contains two effects that can greatly enhance sounds:

- Reverb makes your sounds seem as if they're playing in a large room or concert hall.
- Chorus adds a lovely swirling shimmer to your sounds.

Either of these effects can be turned on or off at any time. They can be used alone or together. You can also adjust the volume of the reverb and/or chorus.

To Turn the Reverb or Chorus Effects On

- To activate the reverb effect, press the Reverb button so that its LED lights.
- To activate the chorus effect, press the Chorus button so that its LED lights.

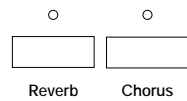

To Adjust the Volume of an Effect

If the desired effect is not currently active, click its button once to activate it. The Avista's display will show "REVERB DEPTH" or "CHORUS DEPTH."

To decrease or increase an effect's volume:

1. Press and release the desired effect's button.
2. Press the minus button to decrease the effect's volume, or the plus button to increase it.

Note: If both effects are turned on, the display will show "CHOVERB DEPTH," allowing you to adjust their volumes simultaneously.

RECORDING MUSIC IN THE AVISTA 7600

The Avista 7600 contains a recorder that you can use to capture your playing. When you play the Avista's keyboard and use its foot pedal, each activity automatically generates MIDI data—in fact, it's this MIDI data that causes the Avista's sounds to play. The Avista's recorder is, technically, a *MIDI sequencer* that records all of this data, including:

- which keys you pressed, and when
- how hard you struck the keys
- how long you held down the keys
- when and for how long you depressed any connected foot pedals

When the sequencer plays back the data, the Avista's sounds play just as they did when you played the keyboard, though, of course, you don't see the keys or foot switches move. In a sense, the recorder acts much like an old player piano: it doesn't record music itself; rather, it records the motions of the keyboard and foot switches.

This has a few interesting advantages:

- You can use the Tempo buttons to change the recording's tempo as it plays back.
- You can re-orchestrate the music by selecting a different sound.
- You can easily store a large number of recordings on any single floppy disk, since MIDI data is much more compact than actual recordings of sound.

Tip: If you've got a computer with a MIDI sequencing program, you can load your recordings into the computer from floppy for further work.

The Rec/Play Controls

The Avista's recorder uses a set of buttons that serve a dual purpose: when the Disk LED is unlit, the buttons operate the recorder; when the LED is lit, they control floppy disk operations. To light or unlight the LED, press the blue Disk-Rec/Play button.

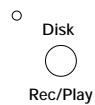

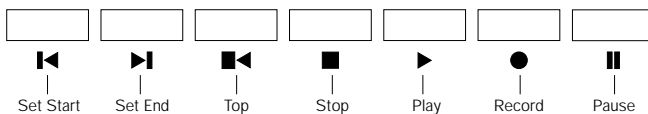

The symbols beneath the buttons show their function when used to control the recorder.





Making a Recording

Making a recording in the Avista is simple. To record your playing:

1. Select the time signature and tempo to be recorded using the Meter and Tempo buttons, as described on Page 12.
2. Press the Record button. You'll hear a one-measure countoff, after which recording will actually begin. 
3. The Avista will begin recording as soon as you start playing.
4. When you're done recording, press the Stop button. 

Tip: If you'd like a rhythmic reference as you record, turn on the metronome prior to Step 2 (see Page 12). If you'd like to record after a one-measure count-off, quickly press the Record button twice in Step 2 above.

To Play Back a Recording

1. Rewind the recorder back to the beginning—or “top”—by pressing the Top button. 
2. Press the Play button to begin playback. 

Using the Other Recorder Controls

- If you'd like to stop playback before the end of the recording, press the Stop button.
- To suspend playback, press the Pause button. To resume, press Pause again, or press the Play button. 

Playing a Specific Portion of Your Recording

During playback, press the Set Start button at the beginning of the section you want to hear, and the Set End button at its end. When you next play the recording, only the music between these two locations will be heard. To listen to the recording from its beginning or to its end, press the Stop button and then click the Start or End button, respectively.



To Make a New Recording

To make a new recording, press the Top button to return to the beginning of your recording, and then repeat the steps in “Making a Recording” above. The new recording will replace the old one.

To Change a Recording's Tempo

During playback or when the recorder is stopped, you can alter the tempo of a recording you've made by performing the following actions.

- To slow the tempo of a recording, press the left-hand Tempo button repeatedly until the desired tempo is heard and /or displayed.
- To speed up the tempo of a recording, press the right-hand Tempo button.

To Re-Orchestrate a Recording

You can re-orchestrate a recording at any time—during playback or when the recorder is stopped—by selecting a new sound to play the recorded MIDI data. To select one of the preset sounds, press one of the eight sound buttons (described on Page 8). To pick a sound that's not assigned to a sound button, press any of the buttons and repeatedly press the minus or plus button to select the desired sound.

USING THE AVISTA FLOPPY DRIVE

The Avista's built-in floppy disk drive allows you to store your recordings on high-density (HD) 3.5" floppy disks. These disks can be purchased at any computer supply outlet and many stationery stores. Once saved to a floppy disk, you can re-load and play your recordings at any time.

Tip: You can also use the Avista's drive to load and play pre-recorded GM songs in Standard MIDI File format.

The Disk Controls

Floppy-disk-related operations are accomplished by pressing the same buttons used when operating the recorder. When the Disk LED is lit, the buttons are assigned to floppy-disk duty. To turn the LED on, press the blue Disk-Rec/Play button.

The label above each button shows the button's purpose when used for disk operations.

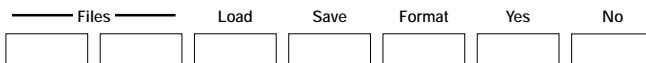

The Floppy Drive

The Avista's floppy drive is located on its rear panel to the left of its connection jacks, when viewed from the back. The drive's face provides a slot into which a floppy can be inserted for use in the Avista.

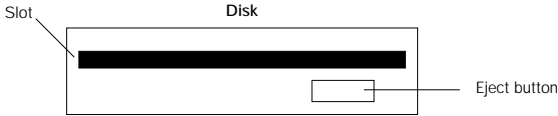

Note: The floppy drive is a sensitive piece of electronic equipment and, as such, should be treated with care. See "The Care and Feeding of the Floppy Disk Drive" on Page 23.

A disk is inserted into the drive—label-side up, with its shutter window to the right—by sliding the floppy into the drive's slot until the drive grabs the disk and seats it in the drive's mechanism.

To remove a floppy from the drive, press the drive's Eject button, shown above.

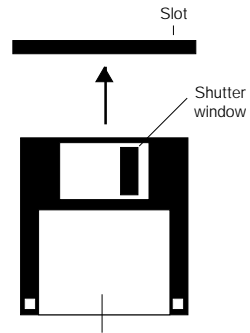

Working with Floppy Disks

Write-Protection

Floppy disks can be write-protected to prevent you from accidentally writing new disk files over already-saved files that you don't want to erase. Therefore, if you intend to save your recordings to a floppy, you must make sure that the floppy is not write-protected prior to inserting it into the drive for use. You can tell if a disk is write-protected by turning it over—so that it's label-side-down—and examining the small window in its lower-right-hand corner.

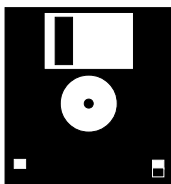

If the tab is in the down position and the write-protect window is open, the disk is write-protected. It can only be read.

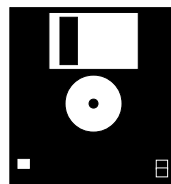

If the tab is in the up position, the write-protect window is closed, and the disk is not write-protected. It can be written to and read.

Formatting a Floppy Disk for Use

Before a floppy can be read or written to by the Avista, its data structure must be *formatted*. The Avista uses a standard DOS format, so its disks can be formatted in any computer that supports DOS formatting. In addition, the Avista offers its own formatting utility. An un-formatted disk only needs to be formatted the first time it's used.

Warning: Formatting completely erases a floppy disk. Before formatting a floppy, make sure that it contains no data that you want to keep.

To format a floppy in the Avista:

1. Make sure the disk is not write-protected.
2. Insert the floppy into the drive.
3. Press the blue Disk-Rec/Play button, if necessary, to ensure that the Disk LED is lit.

4. Press the Format button.



The display will show:



5. If you're ready to proceed, press the Yes button. If you want to cancel the operation, press the No button.

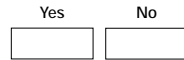

If you press the Yes button, the Avista will proceed to format the floppy. The procedure takes a few moments—the Avista's display will tell you when formatting is complete.

Saving Your Recordings to Disk

To save a recording to disk:

1. Insert a formatted disk into the floppy drive.
2. If the Disk LED is not already lit, press the Disk-Rec/Play button.

3. Press the Save button.



The display will show:



“SONG_000.MID” is the default name for the first disk file to be saved since powering up the Avista. As you save additional recordings, the number in the default name will grow. You can select your own eight-character name for the disk file, as described below. If you’d like to use the default name, skip to Step 8.

Note: Each name is followed by “.MID,” the required file extension for Standard MIDI Files, the type of file that the Avista uses. Standard MIDI Files (SMFs) can be loaded from floppy into any computer or external sequencer that supports Standard MIDI Files.

4. Note that the “S” in “SONG” is underlined. The underline shows that you can change this character. Press the minus or plus button repeatedly to select the desired first letter of the disk file’s name.

Each of the eight sound buttons beneath the display selects one of the eight characters in your disk file’s name for editing.

5. Press the second sound button (Piano2)—notice how the underline moved beneath the second character on the display to show that it can now be edited.
6. Press the minus or plus button repeatedly to select the desired second letter of the disk file’s name.
7. Repeat Steps 5 and 6 to select each of the characters required to spell out your intended disk file’s name.
8. When you’ve finished naming your disk file—or if you skipped here from Step 3—press the Yes button to finish saving your recording to floppy. To cancel the operation, press the No button.

Updating and Over-Writing Disk Files

If a file already exists on the floppy with the name you’ve selected, the display will show:

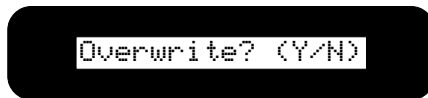

If you press the Yes button, the Avista will replace the disk file with the music currently in the recorder. If you’re updating an already-saved recording and want to replace the old version, press the Yes button to proceed. If you want to preserve the file already on disk, press the No button and repeat the steps above to save the current recording with a different name.

Loading Recordings from Disk

The Avista 7600 can load any SMF-format disk file—within the limits of its available memory—from a floppy, whether it’s a recording made on the Avista, or elsewhere. To load a disk file:

1. Insert the desired disk into the floppy drive.
2. If the Disk LED is not already lit, press the Disk-Rec/Play button.
3. Press the Load button. 

The display will show the name of the first SMF file it finds on the floppy.

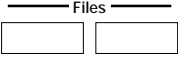
4. To view the names of other SMFs on the disk, repeatedly press the right-hand File button. To move backward in the list of files on the disk, press the left-hand File button. 
5. When the name of the file you wish to load is displayed, press the Yes button to load the file into the recorder.

Warning: When you load a recording into the recorder, it replaces the recording currently in the recorder’s memory. If you wish to preserve this recording, save it to floppy before loading a new one.

Muting an SMF Recording’s Melody

You can silence any of the tracks—including the melody—in a loaded SMF, allowing you to play or sing along.

To mute a melody track:

1. Select the melody track by pressing the Channel button repeatedly until the track’s number is shown on the left side of the display. 
2. Press the minus button—a small “m” will appear in the display to show that the track’s sound is muted.
3. To un-mute the melody, press the plus button.

THE AVISTA 7600 AND MIDI

The Avista 7600 can transmit MIDI data from its keyboard and foot pedal(s), allowing you to use its keyboard to control an external MIDI instrument, such as an external sound module or MIDI sequencer.

In addition, MIDI data that the Avista 7600 receives from an external device can play its internal sounds.

Note: The transmission and/or reception of MIDI data is dependent on the proper connection of MIDI cables. See Page 5.

Transmitting MIDI from the Avista 7600

MIDI data can travel from one instrument to another on any of 16 channels. The Avista can transmit data from its keyboard and foot pedal(s) on any MIDI channel you desire.

To Select the Channel on Which the Avista Transmits MIDI Data

1. Press the Channel button. The display will show the settings for the first MIDI channel, Channel 1.



- The number at the left of the display shows the number of the MIDI channel being viewed.
- The asterisk after the “1” shows that the Avista will transmit its MIDI data on this channel.
- The sound currently assigned to the channel is shown to the right.

Tip: Use the sound or plus and minus buttons to select a sound to be played by the Avista—as you select a sound, a Program Change value corresponding to the sound’s number will be transmitted via MIDI.

To view the settings for the other 15 channels, repeatedly press the Channel button—after Channel 16, the display will return to Channel 1.

To change the channel on which MIDI data will be transmitted, navigate to the desired channel’s display as described above, and press the plus button—an asterisk will appear next to the channel’s number.

Note: Only one channel may be selected at a time for the transmission of MIDI data.

Receiving MIDI Data on the Avista 7600

The Avista can automatically receive MIDI data on any or all of the 16 MIDI channels at any time—no action is required on your part to activate this feature. An external MIDI device can select the desired sound for each channel and set its volume, stereo placement and so on. The sound for each channel plays according to the MIDI instructions the Avista receives. This feature allows you to use the Avista’s superior sounds for the playing of General MIDI recordings from a computer or other external sequencer.

You can, if you like, silence, or “mute,” the Avista’s sound on any of the 16 MIDI channels when it receives MIDI data from an external source.

Muting a MIDI Channel

To mute a MIDI channel:

1. Select the desired channel by pressing the Channel button repeatedly until the channel’s number is shown on the left side of the display.  Channel
2. Press the minus button—a small “m” will appear in the display to show that the channel’s sound is muted.
3. To un-mute the sound, press the plus button.

Viewing the Sounds Played on Each MIDI Channel

You can view the sound being played by each MIDI channel when the Avista receives MIDI data. to do this:

1. Select the desired channel by pressing the Channel button repeatedly until the channel’s number is shown on the left side of the display.  Channel
The display will show the sound being played by the channel.

PROPER OPERATION OF THE AVISTA 7600

Temperature Guidelines

The Avista 7600 contains a substantial amount of computerized and electronic circuitry that can be susceptible to damage when exposed to extreme temperature changes. When the Avista 7600 is brought inside after sitting in a cold climate (i.e., the back seat of your car), condensation builds up on the internal circuitry in much the same way a pair of glasses fogs up when you come inside on a cold day. If the unit is powered up as this condensation occurs, components can short out or be damaged. Excessively high temperatures also pose a threat to the unit, stressing both the internal circuits as well as the case. With this in mind, it is highly advisable to follow these precautions when storing and setting up your Avista 7600:

- Avoid leaving the Avista 7600 in temperatures of less than 50 degrees Fahrenheit or more than 100 degrees Fahrenheit.
- When bringing the Avista 7600 indoors after travel, allow the unit at least 20 minutes to reach room temperature before powering up. In the case of excessive outdoor temperatures (below 50 degrees Fahrenheit or above 100 degrees Fahrenheit), allow an hour or more before power up.
- Avoid leaving the Avista 7600 inside a vehicle exposed to direct sunlight.

Care and Feeding of the Disk Drive

The Avista 7600's disk drive is used to store sounds, rhythms, and sequencer data. This disk drive will store your data on a high-density (HD) 3.5" floppy disk.

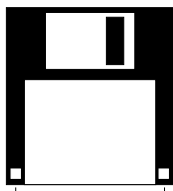

HD floppies have two windows.

Floppy disks are a magnetic storage medium, and should be treated with the same care you'd give important audio tapes. Just as you would use high quality audio tapes for your important recording needs, we recommend using high quality floppy disks for your Avista 7600. Here are a few Do's and Don't's concerning disks and the disk drive.

Do's:

- Use high-density (HD) 3.5" disks.
- Keep your disks and the disk drive clean and free of dust, dirt, liquids, etc.
- Label your disks and keep a record of what is saved on each.

Don't's:

- Don't use single-sided (SD) disks. These disks have not passed testing on both sides. While a single-sided disk might work with the Avista 7600, it is possible that you will eventually lose important data to a disk error if you try using single-sided disks.
- Don't put anything other than a disk into the disk drive.
- Don't transport the unit with a disk in the drive.
- Don't expose disks to temperature extremes. Temperatures below 50° F and above 140° F can damage the plastic outer shell.
- Don't expose your disks to moisture.
- Don't subject disks to strong magnetic fields. Exposure to magnetic energy can permanently damage the information on the disk. Keep disks away from speaker cabinets, tape decks, power cables, airline x-ray equipment, power amplifiers, TV sets, and any other sources of magnetic energy.
- Don't eject the disk while the drive is operating.

Clean-Up and Maintenance

Clean the exterior of your Avista 7600 with a soft, lint-free, dry (or slightly damp) cloth. You can use a slightly dampened cloth (with a mild neutral detergent) to remove stubborn dirt, but make sure that the Avista 7600 is thoroughly dry before turning on the power. Never use alcohol, benzene, volatile cleaners, solvents, abrasives, polish or rubbing compounds.

Polarization and Grounding

Like many modern electrical devices, your ENSONIQ product has a three-prong power cord with earth ground to ensure safe operation. Some products have power cords with only two prongs and no earth ground. To ensure safe operation, modern products with two-prong power cords have polarized plugs which can only be inserted into an outlet the proper way.

Some products do not have polarized plugs and can be connected to an outlet incorrectly. This may result in dangerous high voltages on the audio connections, which could cause you physical harm or damage any properly grounded equipment to which they are connected.

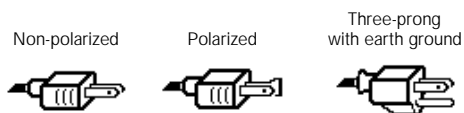

We recommend observing the following precautions:

- If you own equipment with two-pronged power cords, check to see if they are polarized or non-polarized. You might consider having an authorized repair station change any non-polarized plugs on your equipment to polarized plugs to avoid future problems.
- Exercise caution when using extension cords or plug adapters. Proper polarization should always be maintained from the outlet to the plug. The use of polarized extension cords and adapters is the easiest way to maintain proper polarity.
- Whenever possible, connect all products with grounded power cords to the same outlet ground. This will prevent equipment damage and minimize hum in the audio output.

AC outlet testers are available from many electronic supply and hardware stores. These can be used to check for proper polarity of outlets and cords.

AC Line Conditioning

As with any computer device, the Avista 7600 is sensitive to sharp peaks and drops in the AC line voltage. Lightning strikes, power drops, or sudden and erratic surges in the AC line voltage can scramble the internal memory, and in some cases, damage the unit's hardware. Here are a few suggestions to help guard against such occurrences:

- A surge/spike suppressor. A surge/spike suppressor absorbs surges and protects your gear from all but the most severe over-voltage conditions. You can purchase multi-outlet power strips with built-in surge/spike suppressers.
- A line conditioner. This is the best, although more expensive, way to protect your gear. In addition to protecting against surges and spikes, a line conditioner guards the equipment against excessively high or low line voltages. If you use the Avista 7600 in lots of different locations with varying or unknown AC line conditions, you might consider investing in a line conditioner.

AVISTA 7600 USER'S GUIDE

Part Number 9310023301-A

Model Number MM 171

