

# 2.0 Software Addendum

*audity* 2000



**E-MU**

E-MU PN FI 10383 Rev. A



# Audity 2000

## 2.0 Software Addendum

### New Features in Version 2.0

Page

4. Up to 64 voice Polyphony!
4. Additional user presets! 4 banks of 128 user presets.
4. New main display screen shows preset and ROM group.
4. New Sound Navigator feature allows you to browse sounds by ROM Group, Preset Number, Bank, Preset Category or Preset Name.
6. New Bank Select protocol for selecting USER, AUDTY, or XTREM banks over MIDI.
7. Multi-setups allow you to save 16 “snapshots” of Audity’s current Master menu/Preset/Volume/Pan/Arp configuration.
10. MIDI All Notes Off/All Sound Off/Reset All Controllers bug fix
10. Arpeggiator Resolution knob bug fix description
11. New Mix Output screen adds another FX Send and shows the true routing of signal to FX engine or submix outputs.
12. FX B Delay Time can now be controlled by internal or external clocks.
13. Arpeggiator knobs can now be generic controllers.
14. New Preset FX PatchCords allow you to modulate effects amounts.
14. New Edit All Layer parameter
14. New Solo Layer parameter
15. 9 New LFO waveforms! (17 total)
16. New Envelope Repeat mode for Filter and Auxiliary Envelopes.
16. Audity now contains 12 User Tuning Tables and 12 Factory Tables.
19. New Demo Sequence screen.
20. New Copy Preset Bank function.
20. Random Preset creator makes amazing new presets using random components of the presets in ROM.
22. New Clock/Tempo display screen.
22. Preset Tempo Offset screen allows you to offset the tempo parameters in the preset by any arbitrary value.
  - Support for the hot new “XTREME” ROM sound set.
  - Improved Reverb algorithms. Smoother and creamier—*like butta!*
  - New Arpeggiator Patterns include with the XTREME ROM set.

## 64 Voice Polyphony

Although its sound engine is designed for 64 voices, Audity was originally a 32-voice machine due to its powerful 12th order filters which used up the available filter resources.

Audity 2.0 is now 64 voice polyphonic when 6th order filters are used or 32 voice polyphonic when all filters are 12th order. Audity's intelligent 2.0 software dynamically allocates filter resources for maximum polyphony in all situations. When using combinations of 6th and 12th order filters the polyphony is between 32 and 64 voices.

## 512 User Presets

By a feat of magic, 256 User Preset locations have been added for a total of 512. The Audity bank contains 640 factory ROM presets and the new *EXTREME* ROM bank contains 256 ROM presets. That's 1408 presets total!

## New Main Screen

Audity's main screen has been improved to show the Preset Bank and to include the Sound Navigator features.

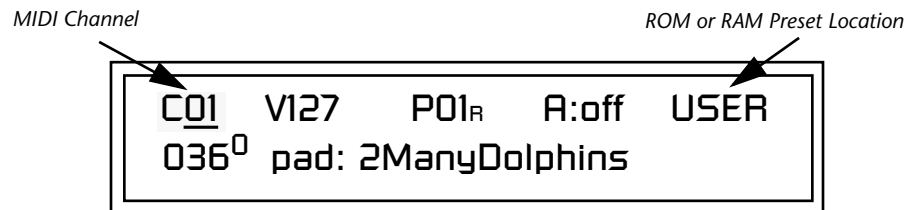

## Sound Navigator

Sound Navigator allows you to search through preset and instrument categories to find the type of sound you're looking for. Each preset and instrument has a name and a three letter preset category. You can create your own categories in order to group favorite presets. The category is assigned in the Edit menu (Preset Name). Instrument categories are fixed.

## Preset Category

When you want to find presets in a particular category, you simply change the category field in the main screen, then move the cursor to the preset name field to scroll through all the presets in the selected category.

When the cursor is on the Preset Category field, turning the Data Entry Control selects different preset categories. The Name Field will change to show the first preset in each category.

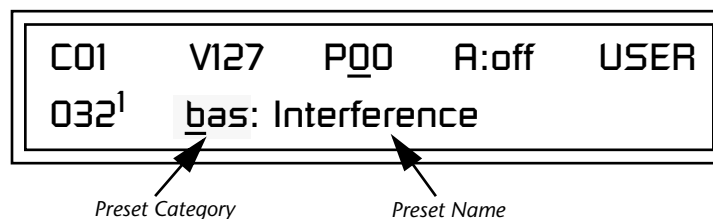

### To Change the Preset Category

1. Press either cursor key repeatedly until the cursor is underneath the Preset Category Field.
2. Rotate the Data Entry Control to select one of the Preset Categories. Preset Categories are displayed in alphabetical order.

### To Select a Preset within a Category

1. After selecting a category, move the cursor to the Preset Name field.
2. Rotate the Data Entry Control to scroll through the presets in the selected category. Note that the preset numbers will no longer change sequentially.

### Compatibility with old Audity presets

Sound Navigator uses the first 4 characters of the Preset name for the Navigator Category. Older Audity presets are not named using the category prefix which would cause problems for Sound Navigator (this would create hundreds of categories). Therefore, old presets are placed in a new category called "usr:" (User) with the actual name listed to the right of the colon, truncated to fit the remaining 12 characters with the following additional rules:

1. If there is a colon in the 4th character space, the name will not be altered in any way. The first 3 characters will simply be used as the category and the rest of the name will remain the same.
2. If there is a character other than a colon in the 4th space, the preset will be assigned to the category "usr:" and the original name will start to the right of the colon, truncating the length as necessary.
3. If the name needs to be truncated, the Audity will first try to remove spaces in the name so that it will fit.
4. Numbers at the end of the name will not be truncated and will remain as the final character of the name.

### *Instrument Category*

When the cursor is on the Instrument Category field (Edit menu), turning the Data Entry Control selects different instrument categories. The Name Field changes to show the first instrument in each category. Move the cursor back to the instrument number to select instruments in the selected category.



1. Choose Category

2. Scroll through Instruments

## New Bank Select Protocol

The MIDI standard calls for a two part bank select command consisting of an MSB (most significant byte) and an LSB (least significant byte). Audity version 1.0 ignored the MSB portion of the message. With the introduction of the new *EXTREME* ROM bank, we have followed the standard MIDI specification for bank selection. Select a bank, then send the program change number. Without a bank select command, presets are selected from within the current bank. The chart below shows the bank select commands for the three sound banks.

<b>MIDI BANK SELECT</b>				<b>MIDI BANK SELECT</b>				<b>MIDI BANK SELECT</b>			
	<b>MSB</b>	<b>LSB</b>		<b>MSB</b>	<b>LSB</b>			<b>MSB</b>	<b>LSB</b>		
	<b>cc00</b>	<b>cc32</b>	<b>RAM</b>	<b>cc00</b>	<b>cc32</b>	<b>ROM</b>		<b>cc00</b>	<b>cc32</b>	<b>ROM</b>	
<b>USER</b>	00	00	Bank 0	<b>AUDTY</b>	03	00	Bank 0	<b>XTREM</b>	02	00	Bank 0
<b>USER</b>	00	01	Bank 1	<b>AUDTY</b>	03	01	Bank 1	<b>XTREM</b>	02	01	Bank 1
<b>USER</b>	00	02	Bank 2	<b>AUDTY</b>	03	02	Bank 2				
<b>USER</b>	00	03	Bank 3	<b>AUDTY</b>	03	03	Bank 3				
				<b>AUDTY</b>	03	04	Bank 4				

In order to maintain compatibility with older sequences which do not send the MSB portion of the Bank Select, there is a special feature added in software version 2.0. If no MSB is sent, Audity assumes MSB 0 and all LSB bank selects will act as in version 1.0 (i.e. your old sequences will work). Once an MSB other than 0 is sent, Audity assumes that any LSBs are to be applied to the most recent MSB.

If you have older sequences that send only the Bank Select LSB, it's probably a good idea to update the sequences to include both the MSB and LSB. Otherwise, if you ran a newer sequence that included an MSB, LSB bank select, presets in your older sequence may not be selected correctly.

<b>New AUDTY Bank Ordering</b>			
	<b>LSB</b>	0	User 0
	<b>LSB</b>	1	User 1
<b>New Banks</b>	<b>LSB</b>	2	User 2, defaults to RAM copy of AUDTY 0
	<b>LSB</b>	3	User 3, defaults to RAM copy of AUDTY 1
	<b>LSB</b>	4	AUDTY 2
	<b>LSB</b>	5	AUDTY 3
	<b>LSB</b>	6	AUDTY 4

Audity version 2.0 includes two additional USER preset banks (which default to RAM copies of the AUDTY 0 and AUDTY 1 banks). Your old sequences will work as long as you don't modify the presets they use in these new banks. This is yet another reason to update your sequences with MSB & LSB bank selects.

# Multisetups

A Multisetup is a group of parameters that you might associate with a particular sequence or song. It is like a “snapshot” of the current MIDI channel configuration of the module. There are 16 setups numbered 0-15. Multisetups 0-14 are user programmable. Multisetup 15 is a factory preset.

## A Multisetup includes ALL the following parameters:

- Preset/Volume/Pan/Arp assignments for each of the 16 MIDI channels.
  - Multisetup Name
  - Clock Tempo or “Use MIDI” setting
  - ALL MASTER MENU PARAMETERS except...
- 
- MIDI Program Change->Preset map
  - User Key Tuning Tables



Multisetups can also be restored (selected) via MIDI Bank and Program change commands. Bank Select: MSB = 80, LSB = 00, then send a Program Change command (0-15) corresponding to the Multisetup you wish to select.

### To Enable the Multisetup Menu

Press the **Master** button, lighting the LED. The three Multisetup screens are located near the end of the list. The cursor appears below the first character of the screen heading on line one.

### To Select a New Screen

Press the Home/Enter button or press the Cursor button repeatedly until the cursor is below the screen title heading. Rotate the Data Entry Control to select another screen.

### To Modify a Parameter

Press either Cursor button repeatedly (or hold down the left or right cursor button while turning the Data Entry Control) until the cursor is below the desired parameter value. Rotate the Data Entry Control to change the value.

### To Return to the Main Screen

Press the Master button, turning off the LED.

## Restoring Multisetups



*MIDI Bank Select  
commands are implemented  
using Continuous Controllers.  
MSB = cc00 and LSB = cc32*

Audity 2000 contains 16 Multisetup locations. 15 of these (0-14) are user locations which you can use to store your own Multisetups.

Multisetups can also be restored using a MIDI Bank Select followed by a Program Change command (0-15).

**Bank Select: MSB = 80, LSB = 00**, then send a **Program Change** command (0-15) corresponding to the Multisetup you wish to select.



### **To Restore (Select) a Multisetup:**

1. Press the Master menu button, lighting the LED. The Restore Multisetup screen is the fifth screen from the last in the Master menu. The cursor appears below the first character of the screen heading on line one.
2. Go to the “Restore Multisetup” screen (shown above) using the Data Entry Control.
3. Press either cursor button to move the cursor to the bottom line of the screen.
4. Now, use the Data Entry Control to select a Multisetup. The Enter LED will be flashing.
5. Press the Enter button to load the selected Multisetup.

### **To Save a Multisetup:**

1. Set the Preset, Volume, Pan and Arp settings the way you want them for all 16 channels. Set the Master menu parameters the way you want them.
2. Press the Master menu button lighting the LED and go to “Save Setup To”. This is the third screen from the last in the Master menu.
3. If you wish to name your new Multisetup continue on, otherwise skip to step 6.
4. Scroll to the “Multisetup Name” screen (shown below) using the Data Entry Control.

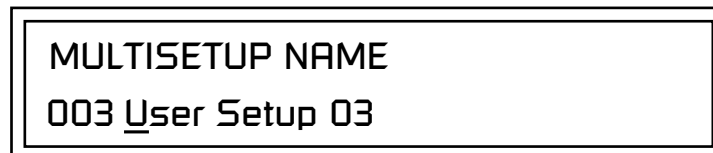



5. Press either cursor button to move the cursor to the bottom line of the screen, then use the Data Entry Control to change letters. Use the cursor buttons to select letters to be changed.
6. Scroll to the "Save Multisetup" screen (shown below) using the Data Entry Control.

**SAVE SETUP to**  
**014 Destination Multisetup**

7. Press either cursor button to move the cursor to the bottom line of the screen.
8. Now, use the Data Entry Control to select the destination location. The Enter LED will be flashing.
9. Press the Enter button to save the Multisetup.

### *MIDI All Notes Off/ All Sound Off/Reset All Controllers*

Audity software version 1.0 did not honor the MIDI channel of the All Notes Off/All Sound Off/Reset All Controllers messages. Instead, it incorrectly affected all channels. This has been corrected in version 2.0.

In addition, All Notes Off now correctly honors the state of the Sustain Pedal. All Notes Off will no longer shut off notes if the Sustain Pedal is held. Notes remain in the Sustain state until the pedal is released. All Sound Off shuts down all notes on the MIDI channel immediately.

### *Arp Resolution Knob*

The behavior of MIDI controller transmission of the Arp Resolution controller (first knob, third row) has changed in Audity 2.0. When the knob is fully clockwise the controller value sent is now the maximum (127). This is the opposite of the Audity 1.0 where the knob transmitted starting at maximum, (127= fully counter-clockwise) and decreased to the minimum as it was turned clockwise.

This could affect sequences authored in version 1.0 where the Arp Resolution knob was recorded into the sequence. The sequence will play back into Audity 2.0 with reversed parameter values on this knob.

## Changes to the Mix Output Screen

The Mix Output parameter allows you to override the routing assignments made in each preset and instead assign the outputs according to MIDI channel. For each of the 16 MIDI channels, you can select Send 1-4, or Preset. When Preset is selected, the output assignment defined in the Preset Edit menu is used.

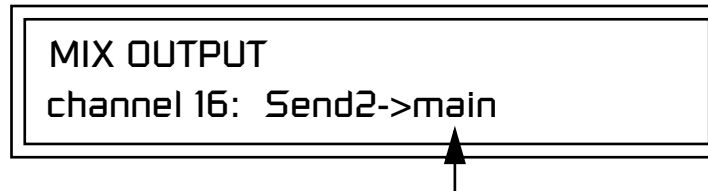

↑  
*Indicates that the signal is routed to the Main output jacks.*

The **Output Routing** field (pointed to by the arrow) reflects the true routing of Send 2 or Send 3 to either:

1) the effects processor input or... 2) the rear panel submix jacks.

If the Sub 1 output is NOT being used, the signal is routed through the effects processors, then on to the main outputs. If a plug were inserted into one of the Sub 1 jacks the destination field would read "Sub1" and the dry signal would be routed directly to the Sub 1 outputs on the back panel.



### Send Routings

- Send 1 - Main Outputs
- Send 2 - Subout 1 or Main Outs
- Send 3 - Subout 2 or Main Outs
- Send 4 - Main Outputs

The Sends function as effect processor inputs (effect sends). Send 2 and Send 3 are also used to route sounds to the Sub 1 and 2 outputs on the back panel. When a plug is inserted into the associated Submix jack on the back panel, the **Dry portion of the Send is disconnected** from the effects processor and the signal is routed directly to the output jack. The actual output routing is shown in parentheses in the display. If you don't want the wet portion of the signal in the main mix, turn down the Send Level. *The Dry Send is disconnected from the Effects Processors even if only one plug is inserted into the Submix jack.*

The four Effect Sends allow you to get the most out of the two effect processors. For example, with Effect B set to an echo algorithm, you could route one MIDI channel to Send 3 and set the effect amount to 80%. Another MIDI channel could be routed to Send 4 with an effect amount of only 5%. This is almost like having two different effects!

The Mix Output function is also useful when sequencing since it lets you route specific MIDI channels (and thus sequencer tracks) to specific Sub outputs (on the back panel) where they can be processed with EQ or other outboard effects.

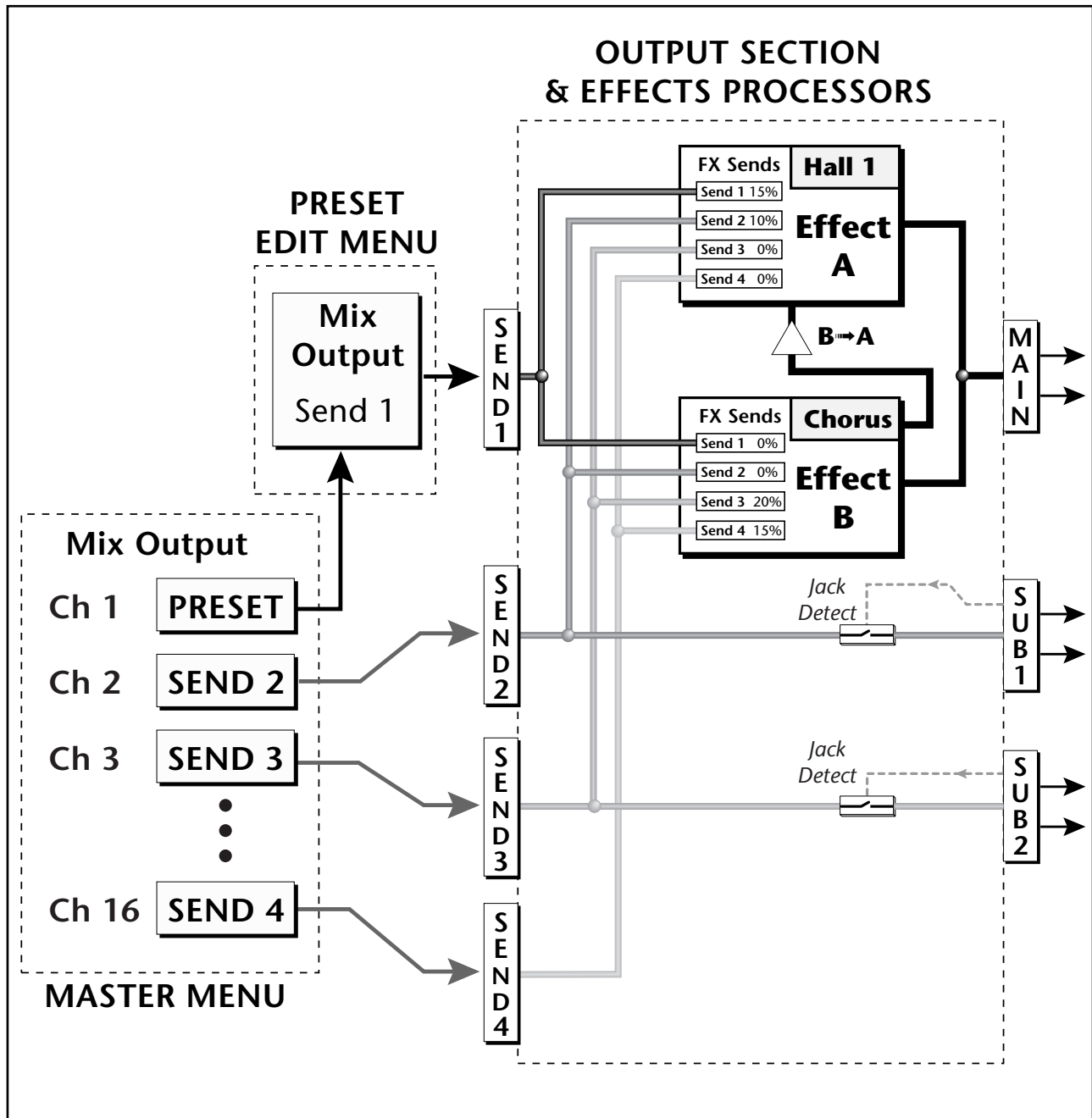

Sends 2 and 3 can be routed to the effects processors or to rear panel submix jacks. When a plug is inserted into a Submix jack, the Dry portion of the Send is disconnected from the effects processor and is routed to the Submix output jacks.

*FXA Submix Routing  
 4 FX Sends*

There are now four FXA sends as described on the previous pages.

FXA SEND AMOUNTS		1 : 10%
2 : 20%	3 : 30%	4 : 0%

*FXB Submix Routing  
 4 FX Sends*

There are also now four FXB sends as described on the previous pages.

FXB SEND AMOUNTS		1 : 10%
2 : 20%	3 : 30%	4 : 0%

*Delay Time can be  
 Controlled by the  
 Master Clock*

FX B Delay times can now be controlled by the Master Clock. This great feature allows you to synchronize echoes with your Arpeggiator patterns or sequences regardless of tempo. Echoes interact with Arp patterns to create complex polyrhythms and syncopations. Use either internal or external clock with any FXB delay effect. Select Delay values before 0mS to access the note values (just like the LFO). **Make sure you try out this feature!!**

FXB	FEEDBK	LFORATE	DELAY
	000	003	1/8

*Real-time Controller  
 Assignments*

Use these three pages to assign **twelve** real-time control sources. The Arpeggiator knobs can now be assigned to any available MIDI controller number and can be patched in the PatchCord screen.

Each MIDI Controller number you select is assigned to a letter (A - L) for internal routing. The front panel Controller Knobs *and* twelve MIDI controller numbers share these A-L controller routings.

 *"Knobs MIDI Out" in the Master menu must be enabled for Audity's controller knobs to be transmitted.*

**These screens let you select which MIDI real-time controller numbers will be received by Audity (from 1 to 31 and from 64 to 95) and which controller numbers will be transmitted over MIDI if the front panel control knobs are turned.** The PatchCord routing and amount in the Edit menu determine what effect the controller has on each preset. Real-time controllers are shown in the PatchCord menu as MIDI A through MIDI L.

 Audity 2000 factory presets have certain synth parameters assigned to each controller letter and so these are "Global" controller assignments.

For example, assigning a MIDI controller to "A" in this screen would let you control filter Fc for all the factory presets.

**REALTIME CONTROLLER #**

**A: 21 B: 22 C: 23 D: 24**

**REALTIME CONTROLLER #**

**E: 25 F: 26 G: 27 H: 28**

**Note:** Controllers 7 and 10 are already assigned to Volume and Pan for each MIDI channel. Controllers 91 & 93 are the standard controller numbers for reverb and chorus send amounts.

Following are a few of the standardized MIDI Controller numbers as defined by the MIDI Manufacturers Association. The controllers shown in **Bold** are automatically routed to the destination (volume & pan) or have their own PatchCord source. Others, such as Portamento Time, can be routed using a PatchCord to have the desired effect.

<b>1 - Modulation Wheel</b>	<b>7 - Volume</b>
2 - Breath Controller	8 - Balance
3 - Aftertouch (Rev. 1 DX7)	9 - Undefined
<b>4 - Foot Pedal</b>	<b>10 - Pan</b>
5 - Portamento Time	11 - Expression
6 - Data Entry	

## Arpeggiator Controller Assign

Use this page to assign four MIDI real-time control sources to the four front panel arpeggiator functions. The arpeggiator controllers use the "single byte" (7-bit) MIDI real-time controller message format and use controllers numbered from 1 to 31 and 64 to 95. **In this screen you set up which controller numbers will be received over MIDI and which controller numbers will be transmitted if the arpeggiator controls are turned.** The "Knobs MIDI Out" feature must be enabled in order to transmit the Arp controllers.

**ARP CONTROLLER#**

**I: 95 J: 81 K: 82 L: 83**

**Please Note:** The arpeggiator functions are *permanently* wired to controllers I-L and any changes made on the assigned MIDI controller number will adjust the associated arpeggiator control.

## Effects Patchcords



The FX Cords allow you to crossfade between effects.

- 1) Set FXA Send 1 to 100%.
- 2) Set FXB Send 1 to 0%.
- 3) Set FX Cord #1 to FXA Send 1 at -100.
- 4) Set FX Cord #2 to FXB Send 1 at +100.

Increasing the controller amount will crossfade from FXA to FXB.

Effects PatchCords give you real-time control of the effects send amounts. You can dynamically adjust the effects mix during a sequence or live performance. The effect processors are a powerful synthesis tool and this feature lets you control and use them in exciting new ways. There are 12 effects PatchCords per preset with a source, a destination and an amount control. The amount can be set from -100 to +100. The effects PatchCord controls are **added** to the FX Send Amounts set in the Master or Edit menus.

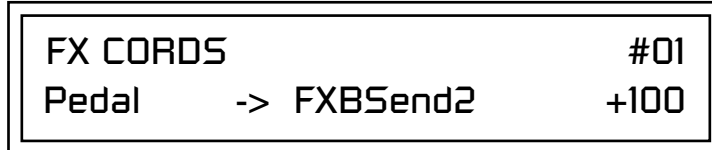

Modulation Sources:	Modulation Destinations
Off	Off
PitchWhl (Pitch Wheel)	Effect A Send 1
ModWhl (Modulation Wheel)	Effect A Send 2
Pedal	Effect A Send 3
MIDI Volume (Controller 7)	Effect A Send 4
MIDI Pan (Controller 10)	Effect B Send 1
MIDI A-L	Effect B Send 2
	Effect B Send 3
	Effect B Send 4

## Preset Edit All Layers Enable



TRY THIS FEATURE!

This function allows you to turn the Edit All Layers feature on or off. "Edit All Layers" is an Edit menu feature which allows you to select all layers (A) in order to edit all four layers simultaneously. Because this feature can be confusing to the beginning programmer, it can be disabled here in the Master menu. Check this feature out when you're ready. It's great!

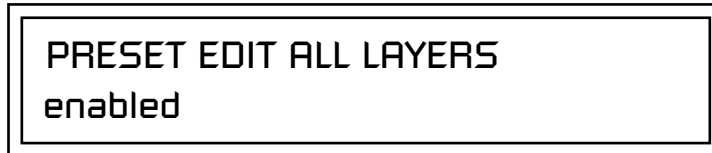

## Play Solo Layers

When constructing multilayer sounds it is often useful to turn off one or more of the layers so you can hear what you're doing! This feature allows you to temporarily solo individual layers or listen to them in any combination. This screen differs from the other Edit screens in that it is NOT saved with the preset. The values reset to "Off" each time you exit the Edit menu.

Solo is activated by setting any layer to On (On = the layer is being Soloed). Any layers set to **On will play** and any layers set to **Off will be muted**. If all layers are set to Off, then Solo mode ends and all layers play normally. When you exit the Edit menu, all layers play normally.

**PLAY SOLO LAYERS**

1: off    2: off    3: off    4: off

*New LFO Waveforms*

Audity now contains 17 LFO waves as shown in the diagram below. The new pattern shapes can be combined (*Send both LFOs to the same destination and adjust the amounts*) for even more variation. Try routing the random wave to the filter cutoff for interesting timbral effects.

**LFO Waveforms**

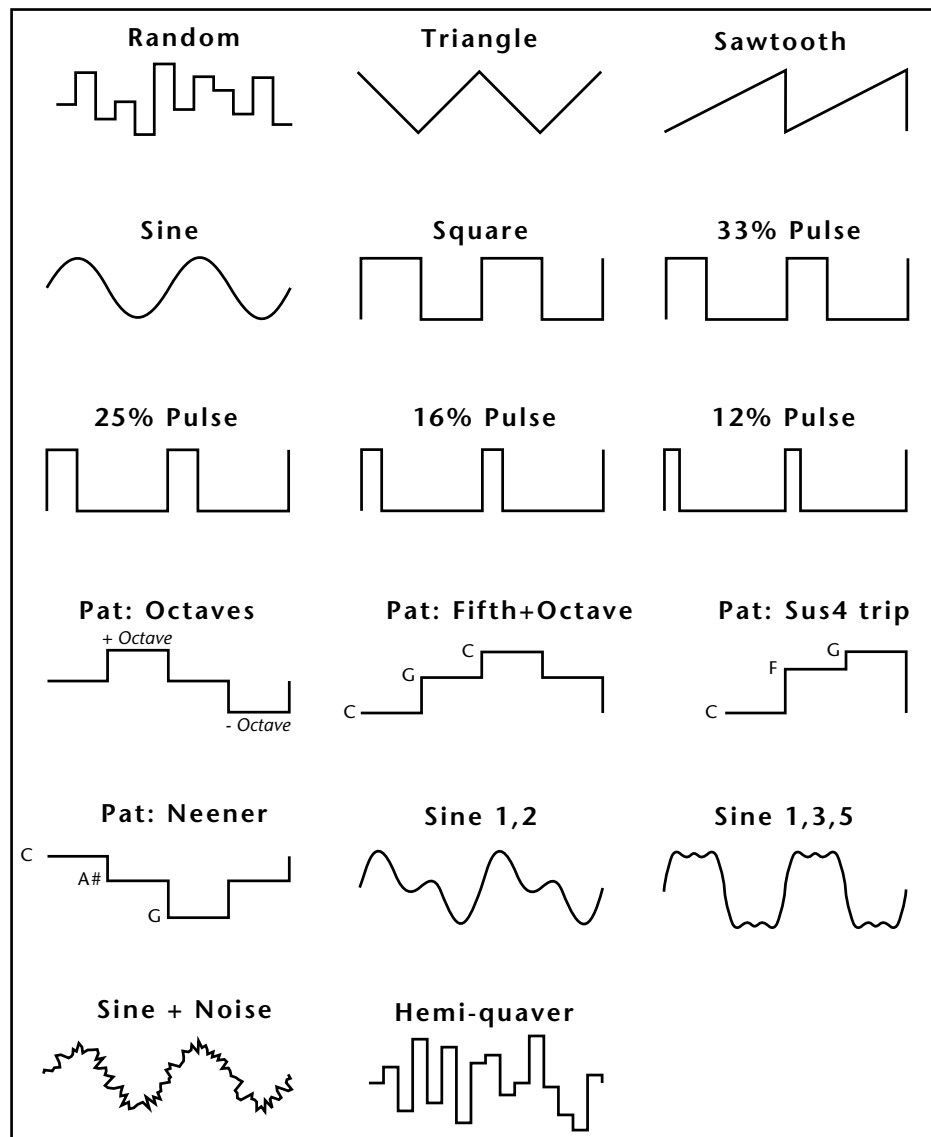

**LFO Tricks & Tips:**

- The Random LFO wave is truly random and is different for each voice and layer.
- The Pattern (Pat) waveforms will sound the same on different layers and voices.
- Sine + Noise is very useful for simulating trumpet and flute vibrato.

★ **When routing Hemi-quaver to Pitch:**

- +38 = major scale
- 38 = phrygian scale
- +76 = whole tone scale
- (+38) + (+76) = diminished (two cords)
- odd amount = S+H sound

**Note:** References to musical intervals in the pattern LFO shapes are with the LFO routed to pitch and a PatchCord amount of +38.

## Envelope Repeat

The Filter and Auxiliary Envelope Generators can now be made to repeat. When the envelope repeat function is On, the Attack (1&2) and Decay (1&2) stages will continue to repeat as long as the key is held. As soon as the key is released, the envelope continues through its normal Release stages (1 & 2). To turn on Envelope Repeat:

1. Move the cursor until it is underneath the Mode field as shown below.



2. Turn the data entry control clockwise. The lower line changes to:



3. Move the cursor underneath the on/off field, then turn the data entry control clockwise so that Repeat is On.

## Tuning Tables

There are now 12 user definable tuning tables and 12 factory tuning tables. The initial frequency of every key can be individually tuned using the user tuning tables, facilitating the creation of alternate or microtonal scales.

The User Tuning Table screen is located in the Master menu. Using the cursor key and the Data Entry Control, select the key name, the coarse tuning and the fine tuning. The key name is variable from C-2 to G8. Coarse Tuning is variable from 0 to 127 semitones. The fine tuning is variable from 00 to 63 in increments of 1/64 of a semitone (approximately 1.56 cents). **For each preset, the specific tuning table is selected in the Edit menu.**



*The user key tuning can be used to tune individual percussion instruments.*

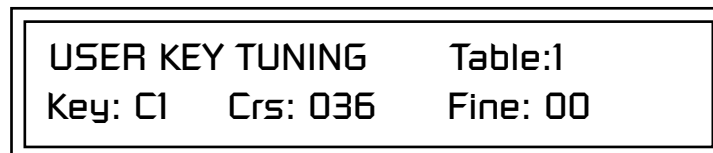

Audity 2000 now contains twelve factory programmed tunings. The Keyboard Tuning parameter in the Edit Menu selects which tuning is used by the current preset. The factory tuning tables are described on the following page.



The factory Keyboard Tuning tables are described in the following table.

<b>Tuning Tables</b>	<b>Description</b>
Equal Temperament	Standard Western tuning (12 equally spaced notes per octave)
Just C	Just intonation. (Based on small interval ratios. Sweet and pure, non-beating intervals.)
Vallotti	Vallotti & Young non-equal temperament. (Similar to 12 tone equal temperament. Each key has a different character for a given scale.)
19-Tone	19 tone equal temperament. (19 notes per octave. Difficult to play, but works well with a sequencer.)
Gamelan	5 tone Slendro and 7 tone Pelog. (Javanese. Pelog are white keys, Slendro are black keys. Exotic tunings of Gamelan flavor.)
Just C2	Allows you to play the following chords in the key of C: C, E, F, G, A, B, C#m, D#m, Em, G#m, Am, Bm
Just C-minor	Allows you to play the following chords in the key of C: C, D <sup>b</sup> , D, E <sup>b</sup> , G, A <sup>b</sup> , Cm, Em, Fm, Gm
Just C3	Allows you to play the following chords in the key of C: C, D, F, B <sup>b</sup> , C#m, Dm, Em, F#m, G#m, Am
Werkmeister III	A "well" temperament developed in the 17th century. Although you can play in all keys, each key sounds slightly different.
Kirnberger	Another well temperament developed by Johann Philipp Kirnberger where no pitch is more than 12 cents off from equal temperament.
Scarlatti	A variant of Meantone tuning which was used from the 15th to 18th centuries.
Repeating Octave	Middle C octave is repeated up and down the keyboard. Link with a preset in equal temperament to form unusual inversion up and down the keyboard.
User 1-12	Define your own tuning tables ( <i>Master menu</i> ).

### The Just C Tuning Tables

Well Tempered and Just were standard keyboard tunings up until the 18th-century when the current "equal tempered" scale became prevalent. In an equal tempered scale, the octave is equally divided into 12 parts. In Just or Well Tempered scales, the 12 notes are separately tuned to produce pure chords. However, in Just tunings you are limited to playing certain chords and if you play the wrong chord it may sound...well, BAD!

Audity 2000 allows you to modulate between keys by providing you 12 user tuning tables. Tuning tables can be changed as you play using a program change (create several presets with the same sound and different tuning tables), by MIDI SysEx command (using a programmable MIDI footswitch



*Audity 2000 implements the MIDI Tuning Dump protocol which allows you to create tuning tables on your personal computer and download them via MIDI. There are several computer applications available on the internet which let you create and download tuning tables via MIDI.*

or other device), or using a continuous controller (link 2 presets and cross-switch between them using a controller).

These new tuning tables take the concept of just intonation a step beyond previous E-mu products. Fully explaining the mysteries of just intonation is beyond the scope of this manual, but the subject is covered exhaustively in Hermann Helmholtz's On the Sensations of Tone, available at most libraries and bookstores.

The new tables are called Just C2, Just C3, and Just C Minor. Try playing in the key of C/Cm using each table. You'll quickly discover both the wonders and the frustrations of just intonation! In Just C, for example, you'll find that the chords C, Em, F, G, and Am sound beautiful. If you hold one of these chords, you'll hear no "beating". After playing for a few minutes, switch back to Equal Temperament for a rude awakening!

At this point you might wonder why anyone would use Equal Temperament to begin with. For the answer to that question, play a D, Dmi, or Bb chord! The intervallic ratios that make the C & G chords sound so pure make the D chord sound horribly out of tune. That's why we had to include Just C3. In this tuning, D, Dmi and Bb sound in tune, but the G chord will sound wrong.

Each of the 4 tables allows you to play a different group of common chords in just intonation. Sadly, there is no single 12 note tuning that will allow all of the common chords to be in tune, and of course that's why they invented the equal temperament tuning system that we use today.

### **Just C**

Play these chords: C, E, F, G, A, Cm, C#m, Em, F#m, Gm, Am

### **Just C2**

Play these chords: C, E, F, G, A, B, C#m, D#m, Em, G#m, Am, Bm

### **Just C minor**

Play these chords: C, D<sup>b</sup>, D, E<sup>b</sup>, G, A<sup>b</sup>, Cm, Em, Fm, Gm

### **Just C3**

Play these chords: C, D, E, B<sup>b</sup>, C#m, Dm, Em, F#m, G#m, Am

## *Playing Demo Sequences*

The Demo Screen has been updated to allow more sequences. The actual number of demo sequences depends on which ROM sounds sets are installed. You can play these demo sequences by accessing the Demo Sequence page.



### **To Play a Demo Sequence**

1. Press and hold both Master and Edit buttons to enter the demo mode.
2. Move the cursor to the lower line of the display using either cursor key.
3. Select a sequence using the data entry control. The Enter LED will be flashing.
4. Press the Enter button to begin playing the selected sequence. The screen shown below appears.



5. Press the Enter button again to stop playing the sequence.
6. When a demo sequence plays to the end, the next demo will automatically begin playing. The screen will display the new demo name.
7. With the sequence stopped, press either the Master or Edit button to Exit demo sequence mode.

## Copy Preset Bank

The new Copy Preset Bank command lets you copy an entire bank from any ROM or RAM bank location to any RAM (user) bank. This function can be especially useful after installing a new sound SIMM.

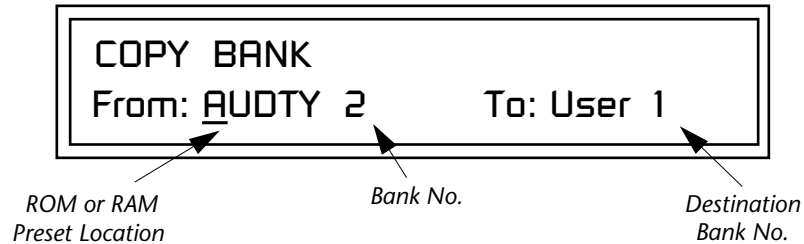

### To Copy a Preset Bank

1. Press the Save/Copy menu button.
2. Move the cursor to the "From" field on the bottom line on the display.
3. Use the Data Entry Control to select the preset bank you want to copy from.
4. Move the cursor to the "To" field on the bottom line on the display.
5. Use the Data Entry Control to select the User preset bank you want to copy into.
6. Press the Enter/Home button to overwrite the bank.

This is a great feature which creates a new preset using portions of the ROM presets as source material. By merging random presets, really great sounding presets can be generated with ease. Use this feature to generate wild new sounds, to get new programming ideas, or just for fun.

## Create Random Preset



### To Create a Random Preset

1. Press the Save/Copy menu button.
2. Use the data entry control to scroll to the Randomize Preset screen. The preset name shown will be the current preset. (*The preset you start with has no effect on the randomization process.*)
3. Press Enter. A new random preset will be created. You need to save this preset if you want to keep it.
4. Don't like the sound? Press Enter again and a new random sound will be generated.

 Examine interesting presets to learn how they work using the Edit menu.

## Multitimbral Sequencing

“Multitimbral” means that Audity 2000 can play multiple sounds at the same time. For a multitimbral sequence to play back correctly, the proper preset must be selected for each MIDI channel. This could be done by inserting preset changes into each track of your sequence before the sequence starts. Audity 2000 also provides another way to store this “pre-sequence setup” using the Multisetup menu.

Using **Multisetups**, you’ll set up the preset, volume and pan settings for each MIDI channel as you build your sequence, then save the Multisetup when it’s the way you want it. Sending one preset change command before the sequence starts selects the Multisetup and MIDI settings for all 16 MIDI channels.

### To Set up Audity 2000 for Multitimbral Operation

1. Set the MIDI mode to “multi mode,” using the MIDI mode function in the Master menu.
2. Decide which MIDI channels you want Audity 2000 to receive (16 channels can be used simultaneously). You can turn any unused channels (or channels assigned to other MIDI devices) OFF using the MIDI Enable function in the Master menu.
3. Select the desired preset for each of the MIDI channels you want the Audity 2000 to receive using the MIDI Channel/Preset selection screen. You can also set the initial Volume, Pan, Arp settings for each channel (as well as the Master Tempo).

1. Select Channel

C01 V127 P00 A:P USER

2. Select Preset

032<sup>2</sup> cmp: Jethro

4. Audity 2000 now responds multitimbrally on each of the MIDI channels you have specified. The volume and pan position parameters can be adjusted dynamically over MIDI (during the sequence).
5. Save the Multisetup.

### To Link a Multisetup with your Sequence

1. Insert a MIDI bank and program change in the lead-in measure of your sequence to select the proper Multisetup before the sequence starts. **Bank Select: MSB = 80, LSB = 00**, on any MIDI channel, then send a **Program Change** command (0-15) corresponding to the Multisetup you wish to select.
2. The Multisetup will now be selected before the sequence starts.

## Base Tempo

Audity 2000 contains an internal Master Clock. The Master Clock controls all the arpeggiators, synchronizes the LFOs when in Tempo-based mode, controls the times of Tempo-based envelopes, and can be used as a modulation source in the PatchCords section. There are two tempo values shown in the display.

- **Base Tempo** - The base tempo is the value to which the MIDI controller specified in the Tempo Controller screen will be applied.
- **Current Tempo** - The current tempo is equal to the base tempo modulated by the MIDI controller specified in the Tempo Controller screen. If no MIDI Tempo controller message has been received since the last Base Tempo change, the Current Tempo will be equal to the Base Tempo.

The LED to the right of the button blinks at the current tempo rate. Current Tempo is NOT displayed when the Base Tempo is set to "MIDI Clock".

### To Change the Master Tempo:

1. Move the cursor to the lower line of the display.
2. Adjust the Base Tempo using the Data Entry Control.

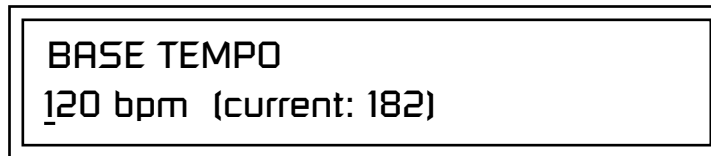

The Master Tempo values range from 1 through 300 beats per minute (BPM) or you can select "use MIDI clock" to use an external MIDI clock source.

## Preset Tempo Offset

This function allows you to double or halve the Master Tempo as it applies to this preset. When playing or sequencing several presets in Multimode, the Master Tempo may be too fast or slow for one preset. Using this feature, you can adjust the tempo for the misbehaving preset. The Tempo Offset can use the **current tempo** or be set to **half** or **twice** the current tempo.







**World Headquarters**

E-mu Systems, Inc. USA

PO Box 660015

Scotts Valley, CA USA

95067-0015

Tel: (831) 438-1921

Fax (831) 438-6812

[www.emu.com](http://www.emu.com)

**Europe, Africa, Middle East**

E-mu Systems, Ltd.

Suite 6 Adam Ferguson House

Eskmills Industrial Park

Musselburgh, East Lothian

Scotland, EH21 7PQ

Tel: +44 (0) 131-653-6556

Fax +44 (0) 131-665-0473