

Handwritten musical score for four staves (1, 2, 3, A). The score includes notes, rests, and dynamic markings such as *pp*, *mf*, *mp*, and *ff*. The key signature is three sharps (F#, C#, G#) and the time signature is common time (C). The notation is dense with various musical symbols and annotations.

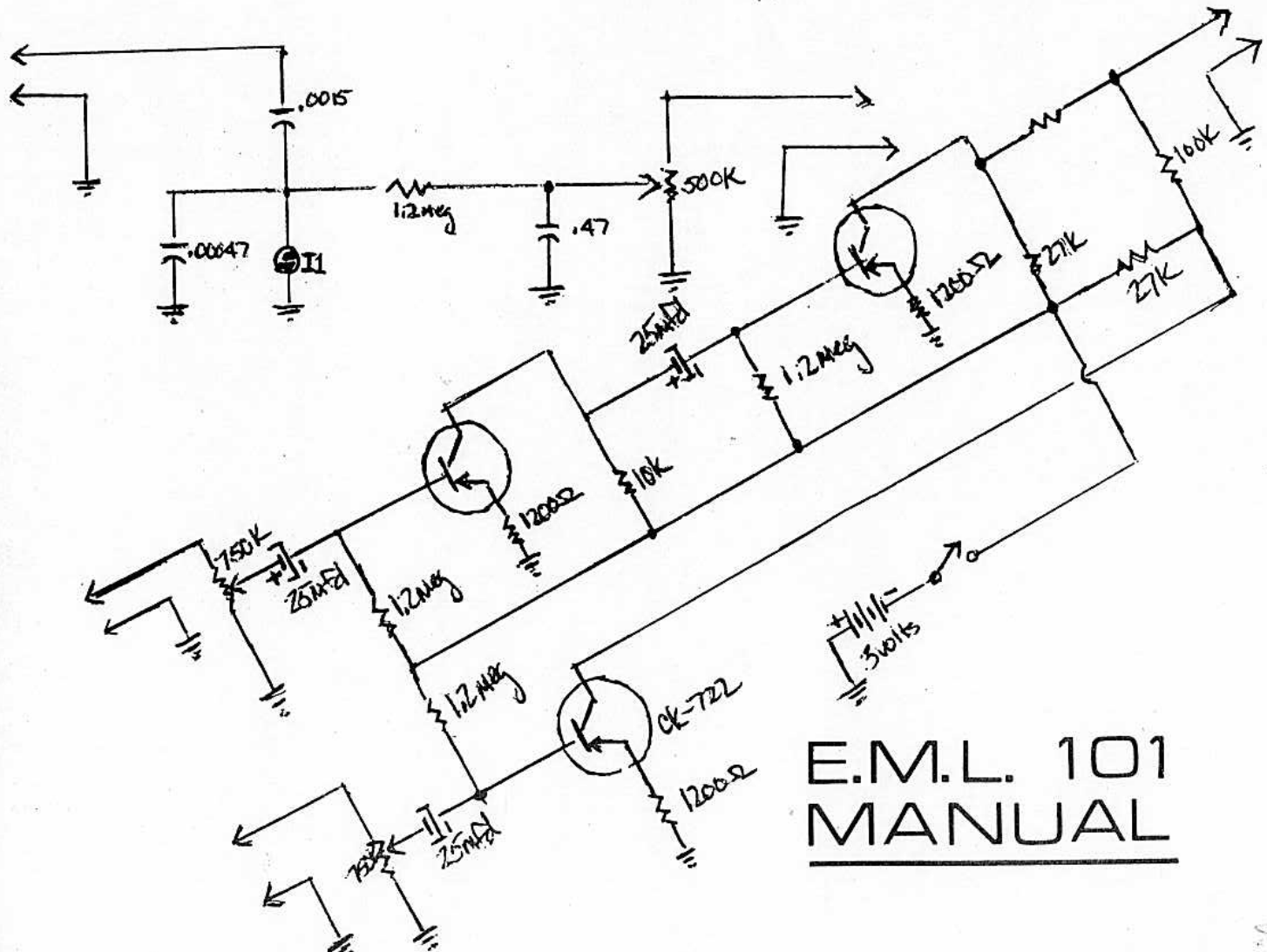

**E.M.L. 101
MANUAL**

THE NEW SOUND IS YOURS. GOOD LUCK AND GOOD FUN. Opening, unpacking and connecting the 101 to your amplifier.	1
THE 101 A simple block diagram of the major synthesizer sections.	5
AUDIO OSCILLATORS The four oscillators of the 101 used as pitch sources.	8
PITCH CONTROL Different methods of varying the pitch of the oscillators, including envelope generators and the sampler.	14
FILTER/TIMBRE CONTROL The principle timbre and modifier of a synthesizer - its use and control.	24
THE MODULATOR Its use in producing tremolos and ring modulation.	34
AMPLITUDE SHAPER/LOUDNESS CONTROL The principle loudness modifier of a synthesizer.	36
TUNING Precise tuning of the 101's oscillators.	38
MISCELLANEOUS 101 SETTINGS Unusual settings of interest.	41
THE 101/200 How to combine the 101 with the 200 Studio Synthesizer.	55

THE NEW SOUND IS YOURS.
GOOD LUCK AND GOOD FUN.

Your EML 101 is a creative tool. A tool which will enable you to generate an incredible variety of sounds, to modify those sounds, and to manipulate them in a musically exciting way.

How long will it take to learn to play? With effort and diligence many musicians are able to "play" the instrument using a variety of synthesizer effects in a period of a week or so. Mastery of the instrument is a different matter. The EML 101 is a complex and sophisticated instrument capable of great musical subtlety and nuance. You can look forward to years of discovery, challenge and reward. If you are adventuresome and innovative the 101 will never wear off.

THE MANUAL ITSELF.

Part I of this manual is designed to introduce you to many of the capabilities of the EML 101 synthesizer. It is somewhat cook-book, but not merely a collection of control settings to make particular sounds. The aim is to point the way, and to develop an understanding of the controls and functions of the synthesizer.

Part II deals with the more technical details of the instrument. After you have developed some facility with the 101 you may find this section will provide additional enlightenment and suggest many avenues for experimentation and the development of new techniques.

The ElectroComp 101 is one of the most sophisticated electronic instruments to reach the consumer. It utilizes some 57 integrated circuits and 75 transistors. It requires only about 15 watts of power. It is sturdily built to withstand long usage. Simply treat it as you would any fine instrument.

SETTING UP.

The 101 is composed of two parts, a keyboard and an electronics panel. For convenience in shipping and carrying they are folded together in one compact case.

To open the instrument, place it on a sturdy flat surface with the keyboard down. (The rubber feet are attached to the keyboard; the carrying handle to the electronics portion.) Open the four latches. Grasp the electronics section at the sides, lift it up and away from the keyboard, and set it down toward the rear of the keyboard.

Remove the power cord and keyboard connector cable from the storage space behind the keyboard. Place the electronics panel over the keyboard so that the latches on the base of the panel section line up with the latches on the side of the keyboard section. Close the latches.

Now plug the 3 pronged power plug into any 110 volt A.C. electrical outlet. If your wall socket will not accept this plug, use a universally available adapter, properly connected, for both safety and reduced hum and noise.

GETTING SOUND.

The 101 is supplied without amplifier or speakers. In order to hear anything you must use a sound system or high impedance headphones (600 ohms). While this may seem inconvenient at first, you should realize that an amplifier and speakers capable of properly reproducing the full range of sounds the 101 can generate could not be fitted into the instrument.

SAVE YOUR SPEAKERS.

A common misfortune suffered by electronic musicians is damaged speakers. Problems can easily be avoided if you follow these instructions.

1. Before making or breaking any connections between an amplifier and the synthesizer, turn the amplifier volume all the way down.
2. Speakers may be damaged by the combination of very high or very low frequencies at HIGH POWER LEVELS. When using the synthesizer in these frequency ranges do not turn your amplifier up beyond moderate listening levels. Leave the volume control set as you would for mid-range use.

With these precautions in mind, you are now ready to connect the 101 to your sound system.

CONNECTING THE AMPLIFIER.

The 101 must be connected to a sound system to produce sound. There are four separate outputs normally available for connecting the 101 to different sound systems. These jacks are located in the OUTPUT MIXER.

The connection to a typical Stereo Amplifier (or Tape Recorder) is normally made with the 6 foot Phone to RCA cord supplied with the 101.

The RCA plug should be connected to the AUXILLARY or SPARE input of your amplifier. If you don't have AUX or SPARE, try the MONITOR or TUNER inputs.

The Phone plug should be connected to the HI level output jack in the OUTPUT MIXER section of the 101.

If the 101's HI level output causes distortion or the Amplifier's volume control must be set very low at normal listening levels, use the LO level output of the 101 instead of the HI level.

If the Amplifier is a typical electronic music amplifier (Guitar type), the connection at the synthesizer will normally be the LO output jack in the OUTPUT MIXER.

For best results with either jack, the volume controls of the FILTER INPUT MIXER and OUTPUT MIXER should generally be turned up at least halfway at normal listening levels. Overall volume can be controlled with the Amplifier's volume control.

TURN ON YOUR AMPLIFIER.

Set the controls as shown below and push a key.

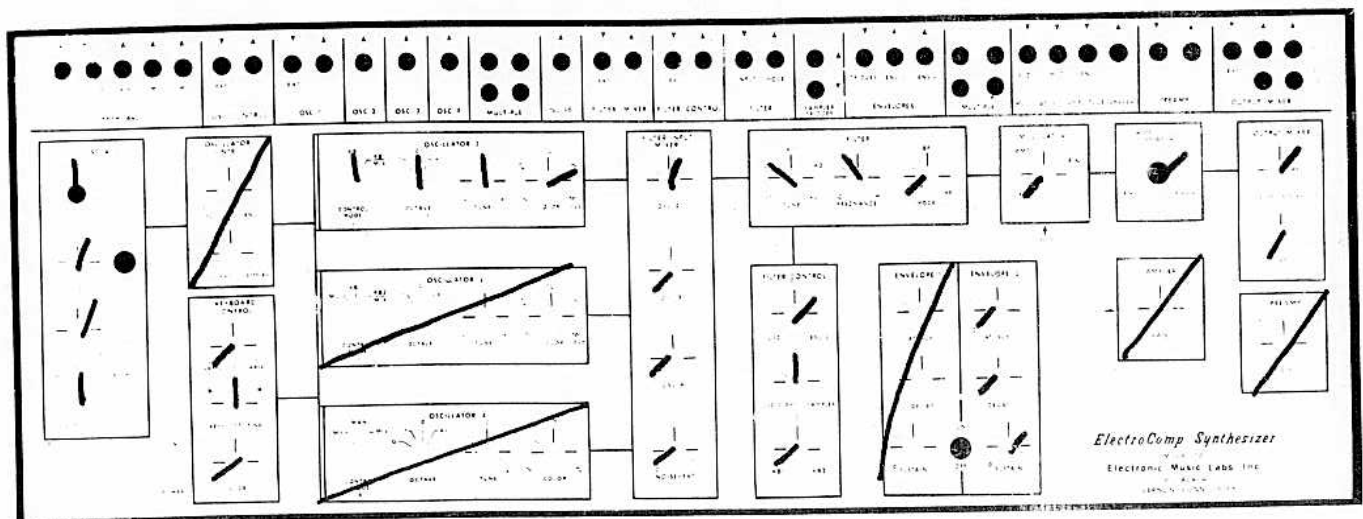

You should hear a sound. If you don't, disconnect the 101 from the amplifier and monitor the 101 with earphones.

If you hear a sound in the earphones, this indicates the problem is with your amplifier.

If you don't hear a sound, check to see that you set the 101's controls as shown.

THE 101.

A synthesizer is an electronic music instrument with the ability to produce almost any sound imaginable. It accomplishes this through control of pitch*, timbre*, and loudness.

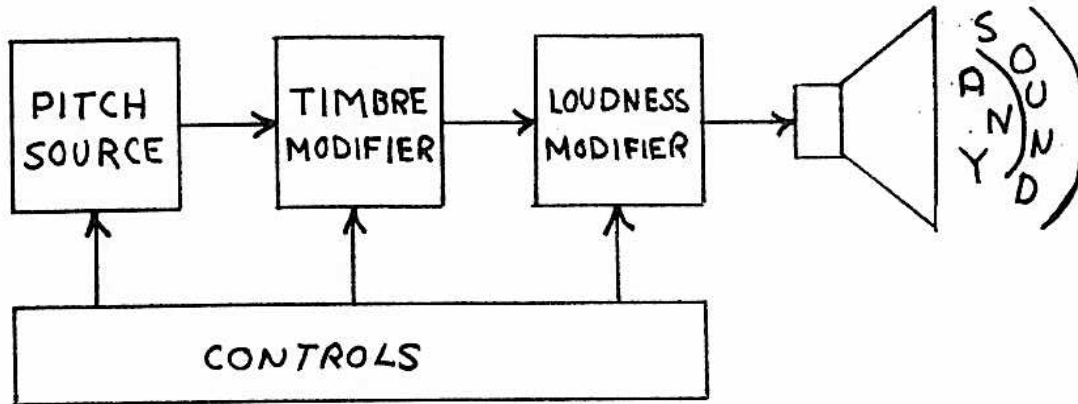

A simpler way to imagine a synthesizer is to consider it to be a rubber instrument. Stretch it here, compress it there, and you can make it sound like most anything.

The functions of the 101 can be divided into three groups:

SOURCES - where pitchs are produced.

MODIFIERS - where timbre and loudness are determined.

CONTROLLERS - where the type and amount of variation in pitch, timbre, and loudness is determined.

SOURCES.

The principle pitch source of a synthesizer is called an AUDIO OSCILLATOR. It produces vibrations of fixed timbre and loudness.

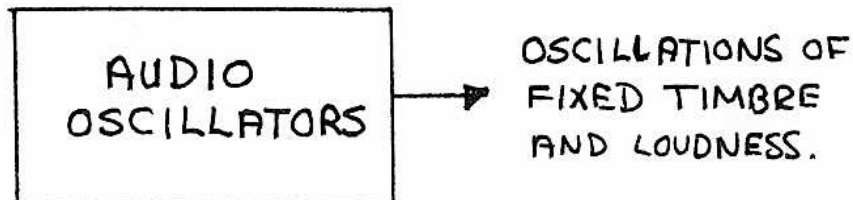

MODIFIERS.

The 101's principle modifiers are the FILTER for controlling timbre

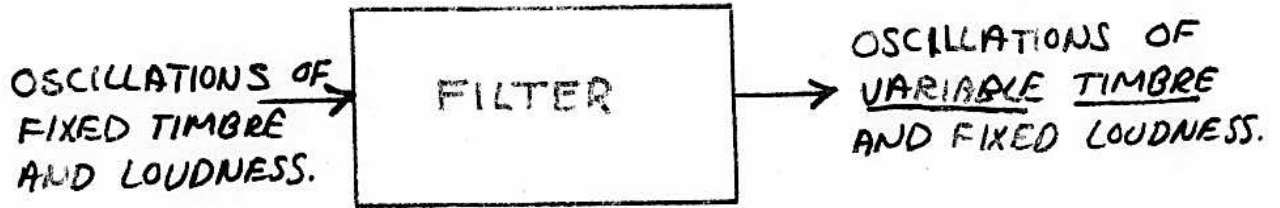

and the AMPLIFIER for controlling loudness.

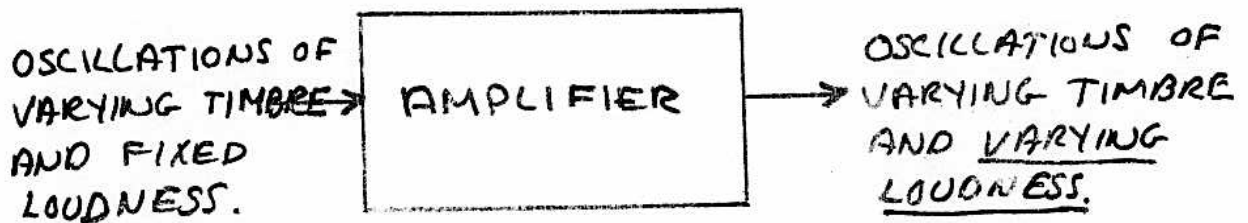

CONTROLLERS.

The 101's principle controller is the KEYBOARD. Each key depression can be used to change the pitch, timbre, and loudness.

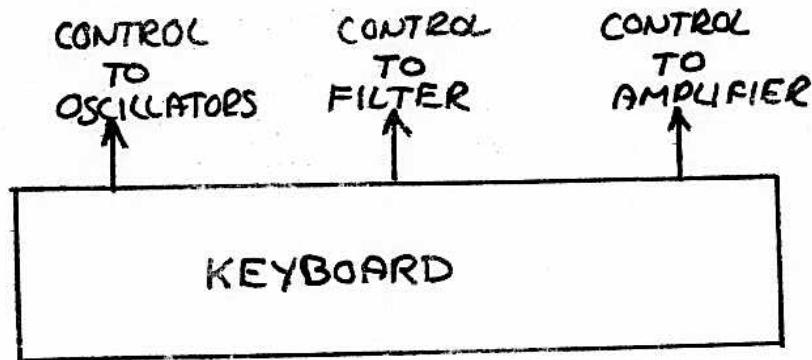

Together these individual functions make up the main part of your synthesizer.

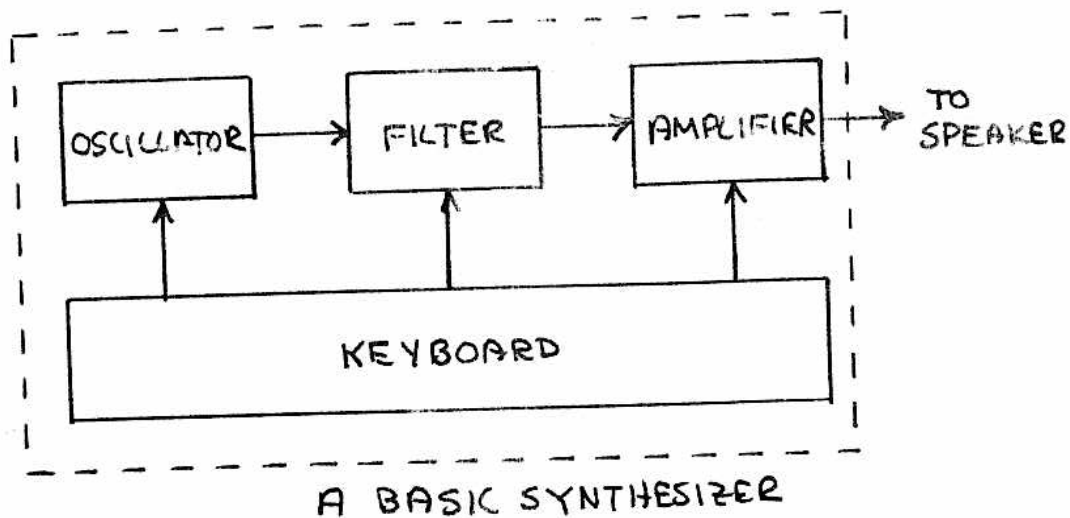

Your ability to produce sounds is directly related to:

1. The sophistication of these functions.
2. Your understanding of these functions.

Understanding of a synthesizer can be of two types:

1. electrical
2. musical

By far, the second is more important. So take your time and discover the musical effect each control has on the sound.

REMEMBER -

1. ANY SOUND CAN BE CREATED THROUGH CONTROL OF PITCH, TIMBRE AND LOUDNESS.
2. EVERY SWITCH OR POT ON THE SYNTHESIZER EFFECTS ONE OR MORE OF THE THREE BASIC PARAMETERS - PITCH, TIMBRE AND LOUDNESS.
3. SOURCES PRODUCE PITCH.
4. MODIFIERS CHANGE TIMBRE AND/OR LOUDNESS OF SOURCES.
5. CONTROLLERS DETERMINE HOW MUCH AND WHAT KIND OF CHANGE IN PITCH, TIMBRE AND LOUDNESS WILL OCCUR.

AUDIO OSCILLATORS.

The primary sound sources of any synthesizer are the audio oscillators. The 101 has four located in the left hand portion of the synthesizer.

An AUDIO OSCILLATOR and guitar strings play the same role in their respective instruments. They both produce vibrations.

The vibrations of the guitar string are mechanical and can actually be seen in the motion of the strings.

The vibrations of the AUDIO OSCILLATORS are electrical and can be seen with the aid of an oscilloscope - a T.V. like device.

Let's start by investigating OSCILLATOR 2. Set the controls as shown below:

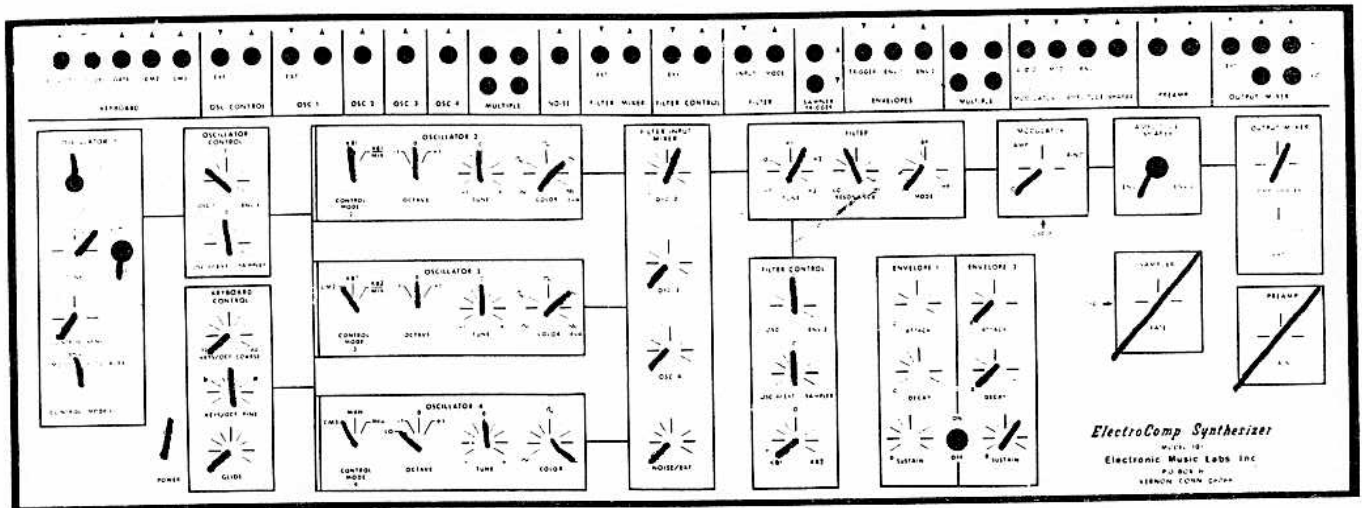

Hold down a key. The pitch you hear is generated by OSCILLATOR 2.

OSCILLATOR 2 has four controls. Two of these controls are used to manually control the pitch of the OSCILLATOR. They are called the OCTAVE and TUNE controls. These controls are analogous to the frets and tuning pegs on a guitar.

Rotate the OCTAVE switch. It shifts the pitch up and down one octave.

Rotate the TUNE pot. It causes the pitch to glissando up and down over a two octave range. With a little practice, a steady hand and a good ear, you will be able to play tunes with this control.

By combining the OCTAVE switch and the TUNE pot you have a usable range of more than four octaves. Note two things:

1. These controls provide basic tuning and range selection for the keyboard (a synthesizer can transpose).
2. When both the OCTAVE switch and the TUNE pot are set to "0", middle C on the synthesizer's keyboard will roughly coincide with middle C on a piano.

An oscillator is like a guitar string in that it generates pitch. It differs from a guitar string in that it vibrates continuously.

You can hear the constant vibrations of OSC 2 by plugging a patchcord from OSC2's output jack into the External Input (♥) jack of the OUTPUT MIXER. If using headphones, you can plug them into OSC 2's OUTPUT (▲) to hear the same thing.

With the synthesizer patched as mentioned above, you are listening to OSCILLATOR 2 connected directly to your amplifier without passing through any synthesizer modifiers.

You can use the COLOR POT on OSC 2 to select different waveforms. The various waveforms determine the timbre or tone color of the pitch.

As the COLOR pot is rotated clockwise, the waveform becomes progressively richer in harmonic content, finally dropping the fundamental pitch and moving up an octave at the extreme clockwise position. Examine the colors available.

These waveforms have been named for the way they look when observed on an oscilloscope - a T.V. like device. Going clockwise, they are:



TRIANGLE WAVE

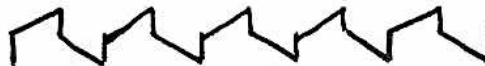

SLOPED SQUARE WAVE



SQUARE WAVE



SAWTOOTH WAVE

Play the keyboard - ad lib with one hand and move the COLOR and OCTAVE controls with the other. The sounds of many different instruments will be suggested. Try to develop a feeling for where various instrumental sounds occur. This knowledge will be very useful later.

Remove the patchcord and return to the setting on page 8.

REMEMBER -

1. OSCILLATORS PRODUCE VIBRATIONS THAT CAN BE HEARD WHEN CONNECTED TO AMPLIFIER/SPEAKERS AND EARPHONES.
2. THE OSCILLATOR HAS AN OCTAVE SWITCH FOR RAISING AND LOWERING PITCH BY OCTAVES.
3. THE OSCILLATOR HAS A TUNE CONTROL FOR TRANSPOSING THE PITCH BY MORE THAN 2 OCTAVES.
4. THE OSCILLATOR VIBRATIONS CAN BE OF DIFFERENT WAVEFORMS. THESE DIFFERENT WAVEFORMS ARE THE BASIS FOR SYNTHESIZING DIFFERENT INSTRUMENTS AND SOUNDS.
5. THE COLOR CONTROL CAN BE USED TO INCREASE THE KEYBOARD PITCH BY PRECISELY ONE OCTAVE WHEN ROTATED FULLY CLOCKWISE.

The final control of OSCILLATOR 2 is the CONTROL MODE 2 switch (KB1-KB1/MIX). This switch determines whether the pitch of the oscillator will be steady or varying.

In the KB1 position the pitch of OSC 2 is controlled by a voltage produced by the lowest key being depressed. As one progresses across the KEYBOARD, the pitch instantaneously jumps with motion from key to key.

In the KB1/MIX position, the pitch of the OSCILLATOR is controlled by both the KEYBOARD and the OSCILLATOR CONTROL mixer (as well as the OCTAVE and TUNE controls). This KB1/MIX position permits a wide variety of vibratos to be produced.

Switch CM2 to the KB1/MIX position and depress a key.

The resultant variation in pitch is being controlled by the OSCILLATOR CONTROL.

Prove this by turning the OSC CONTROL pots to zero until the pitch of OSC 2 is stationary.

The OSCILLATOR CONTROL mixer will be more fully covered under PITCH CONTROL.

REMEMBER -

1. KB1 MEANS THE OSCILLATOR IS UNDER KEYBOARD CONTROL FROM THE LOWEST KEY DEPRESSED.
2. KB1/MIX MEANS THE OSCILLATOR IS UNDER KEYBOARD CONTROL AND OSCILLATOR CONTROL MIXER CONTROL.
3. THE CONTROLS IN THE OSCILLATOR MIXER ONLY FUNCTION IN THE KB1/MIX POSITION.
4. ^{Osc 3 Key} THE OSCILLATOR MIXER CONTROLS DETERMINE THE AMOUNT OF VARIATION THAT WILL OCCUR. THESE CONTROLS ARE TURNED OFF AT 0.

OSCILLATOR 3 is virtually identical to OSCILLATOR 2. Both of these oscillators function only in the audio range, and both have the same range of color. The difference between them lies in their respective CONTROL MODE switches. First turn up the volume of OSCILLATOR 3 in the FILTER INPUT MIXER so that it is the same as OSCILLATOR 2. Then set the CONTROL MODE switch on OSCILLATOR 3 to CM2. This stands for CONTROL MODE 2 and means that OSCILLATOR 3 is controlled by CONTROL MODE 2. In this position, OSCILLATOR 3 will move in parallel with OSCILLATOR 2.

Play the KEYBOARD and note that OSCILLATORS 2 and 3 move in parallel.

Now switch the CONTROL MODE 3 switch to KB2.

Play the keyboard.
Play two notes simultaneously.
You now have polyphonic capability at your disposal.

Very simply:

KB1 refers to the lowest note played on the keyboard.
This is the note that is sounded by OSCILLATOR 2.

KB2 refers to the highest note played on the keyboard.
This is the note that is sounded by OSCILLATOR 3.

OSCILLATOR 4 and OSCILLATOR 1 can both be used as audio oscillators (pitch producing oscillators) as well as sub-audio oscillators (pitch controlling oscillators).

To use these oscillators in their audio ranges, ^{oscillator control must be in mix} move OSCILLATOR 1's HI/LO switch to HI and OSCILLATOR 4's OCTAVE switch to 0.

OSCILLATOR 4 is similar to OSCILLATORS 2 and 3. Its OCTAVE, TUNE and COLOR controls perform similar functions. Its CONTROL MODE switch is different. It can select:

1. CM3 where the pitch is controlled by the same voltages that control OSCILLATOR 3.
2. MANUAL where the pitch is only controlled by the OCTAVE and TUNE controls.
3. MIX where the pitch is controlled only by the OSC CONTROL MIXER.

To hear OSCILLATOR 4, turn up its volume control in the FILTER INPUT MIXER.

With OSCILLATORS 2, 3 and 4 all set to follow KB1, adjust their TUNE pots to produce a chord. Once set, this chord will follow the lowest key you are playing.

OSCILLATOR 1 may be used as a pitch source by patching from OSC 1's output jack (▲) to the FILTER INPUT MIXER's external input (▼) and using the NOISE/EXTERNAL pot to control volume.

Its CONTROL MODE switch selects between:

1. CM2 where OSC 1 moves in parallel with OSC 2.
2. ENV 1 where the pitch of OSC 1 increases as ENV 1's output increases.
3. OSC 4/EXT where the pitch of OSC 1 follows the waveform of OSC 4 or other inputs connected to its external input.

The SENSITIVITY CONTROL above the CONTROL MODE 1 switch is only operative in the ENV 1 and OSC 4 positions of CM1. The SENSITIVITY CONTROL determines the amount of change ENV 1 and OSC 4 will have on the pitch of OSC 1.

patch Osc. 1

REMEMBER -

1. OSCILLATORS SET TO KB1 FOLLOW THE LOWEST KEY BEING DEPRESSED.
2. IF OSCILLATOR 3 IS SET TO CM 2, IT ALSO FOLLOWS THE LOWEST KEY BEING DEPRESSED.
3. IF OSCILLATOR 3 IS SET TO KB2, IT FOLLOWS THE HIGHEST KEY BEING DEPRESSED.
4. OSCILLATORS CAN BE USED FOR SOUND PRODUCING AND SOUND CONTROLLING.
5. OSCILLATORS 1 AND 4 HAVE SUBAUDIO RANGES TO MAKE THEM MORE VERSATILE FOR SOUND CONTROLLING.

PITCH CONTROL.

The OSCILLATORS are the synthesizers primary pitch sources. Their pitch can be changed by a varying voltage, hence the name voltage controlled oscillators.

The primary source of varying voltages is the KEYBOARD. As you progress across the KEYBOARD its voltage increases, causing the pitch to increase.

The outputs of the KEYBOARD are connected to the OSCILLATORS through the KEYBOARD CONTROL.

The KEYBOARD CONTROL determines what kind and how much of an effect the KEYBOARD will have on the pitch.

KEYBOARD CONTROL.

To this point, with each motion from key to key, the pitch instantaneously jumped a precise amount.

There is an alternative to this instantaneous jump in pitch between keys that we've come to expect on pianos and organs. The alternative is called glide or portamento.

GLIDE.

Rotate the GLIDE pot clockwise. Depress low F and F up an octave. Release low F. The pitch gradually slides up to the higher F.

The time required to glide between any two keys is determined by two factors:

1. The position of the GLIDE pot.
2. The distance between successive keys.

Try holding a high key down and trilling a lower key.

An optional GLIDE foot switch may be used for selecting GLIDE.

TUNING.

The two upper pots of the KEYBOARD CONTROL determine how much of a change in pitch moving from one key to the next will cause. These controls are used to set the interval between keys.

When the KEYS/OCTAVE COARSE pot is set fully counterclockwise and the KEYS/OCTAVE FINE is set at "12 o'clock", the interval between notes should be approximately 12 tones per octave - the traditional semi-tone scale.

If you think the interval is not correct, use the KEYS/OCT FINE pot for tuning. Set it so a perfect octave results when you play the bottom F key and then its first octave.

Once you have set the interval for perfect octaves, you can use the oscillator's TUNE pot to tune the synthesizer to other instruments.

A method for extremely precise fine tuning will be described later.

The KEYS/OCT COARSE CONTROL permits the generation of quarter-tone and other unconventional intervals. Rotate this pot clockwise. You will hear the interval between notes decrease.

REMEMBER -

1. THE KEYBOARD PROVIDES A VOLTAGE WHICH CAN INCREASE THE PITCH OF THE OSCILLATORS.
2. THE KEYBOARD CONTROL CONTAINS TWO CONTROLS, KEYS/OCTAVE COARSE AND FINE, WHICH DETERMINE HOW MUCH OF A CHANGE MOVING FROM ONE KEY TO THE NEXT WILL PRODUCE.
3. SEMI-TONE TUNING IS ACCOMPLISHED BY TURNING THE COARSE CONTROL FULLY COUNTER CLOCKWISE AND ADJUSTING THE FINE CONTROL.
4. THE AMOUNT OF GLIDE IS DETERMINED BY THE GLIDE CONTROL.

There are three other forms of varying voltages within the synthesizer commonly used to change the pitch of the OSCILLATORS. They are:

1. control oscillators
2. envelopes
3. the sampler.

They may be used singly or in combination with each other.

CONTROL OSCILLATORS.

Any oscillator in the ElectroComp series of synthesizers may be used for control purposes.

In the 101 two oscillators can be preconnected to the rest to perform this function. They are OSCILLATORS 1 and 4.

The control oscillators are available at the OSCILLATOR CONTROL MIXER. Set the 101 as shown below. Hold a key down.

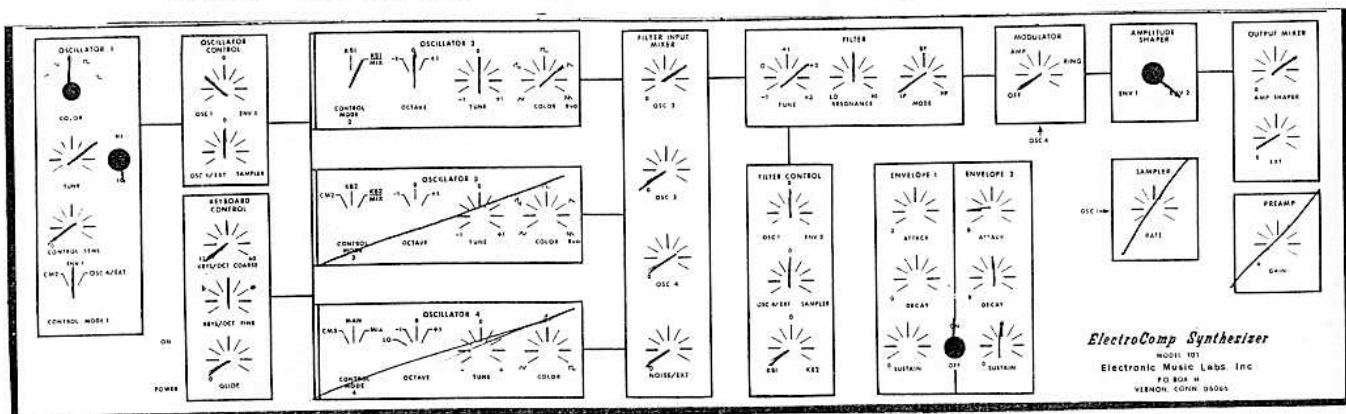

Note that the pitch of OSC 2 is swinging wildly up and down. It is being controlled by OSCILLATOR 1 via the OSCILLATOR CONTROL MIXER.

VIBRATO SHAPE.

If you listen carefully, you will hear that the pitch of OSC 2 coincides with the pattern described by the COLOR switch on OSC 1.

Try switching the COLOR switch of OSCILLATOR 1 to the other positions - the pitch of OSCILLATOR 2 will continue to describe the patterns depicted.

VIBRATO SPEED.

Using the TUNE pot of OSC 1, the speed of vibrato may be varied. The speed may be further increased by a factor of 100 with the TUNE pots associated HI/LO switch.

After experimenting a bit, return the COLOR control to the triangle (▲) and set the TUNE pot to its original position. Address yourself to the OSCILLATOR CONTROL MIXER.

OSCILLATOR CONTROL MIXER.

This mixer determines the amount and type of pitch change OSC 2 will experience when its CM2 switch is in the KB1/MIX position.

The OSCILLATOR CONTROL has two pots. The upper one is marked OSC 1, 0, and ENV 1. This control is turned to OSC 1.

Turn it slowly to 0 and note the result.

All the furious activity of OSC 2 has ceased and it is holding a steady pitch.

Now turn the control slowly back toward OSC 1. At some point you should hear a conventional vibrato. Adjust it to your taste using this control to adjust the amount of vibrato. Use the TUNE control on OSC 1 to adjust the speed of vibrato. This vibrato will remain the same in relationship to OSC 2's pitch regardless of which key is depressed.

Experiment further with this mixer, particularly OSC 4 found on the lower control.

Do not hesitate to vary OSCILLATOR 4's TUNE and COLOR controls.

REMEMBER -

1. OTHER VOLTAGES THAN THE KEYBOARD CAN MAKE THE PITCH OF OSCILLATOR 2 VARY.
2. THESE OTHER VOLTAGES ARE AVAILABLE WHEN OSCILLATOR 2's CONTROL MODE SWITCH IS IN THE KB1/MIX POSITION.
3. THE AMOUNT OF CHANGE IS DETERMINED BY HOW FAR OFF ZERO THE POTS OF THE OSCILLATOR CONTROL MIXER ARE TURNED.
4. THE TYPE OF PITCH CHANGE IS DETERMINED BY TWO FACTORS:
 - A. WHETHER OSC 1, ENV 1, SAMPLER OR OSCILLATOR 4 IS SELECTED IN THE OSC CONTROL MIXER.
 - B. THE SETTINGS OF THE PARTICULAR CONTROL FUNCTION.
5. WHEN OSC 1 IS CONTROLLING OSC 2, THE TYPE OF CHANGE IS DETERMINED BY THE WAVEFORM OF OSC 1; THE SPEED OF CHANGE IS DETERMINED BY THE TUNE OF OSC 1; AND THE DEPTH OF CHANGE BY THE SETTING OF THE UPPER CONTROL OF THE OSCILLATOR CONTROL MIXER.

There are three types of pitch changes that can be produced by the OSCILLATOR CONTROL MIXER.

The most common is the repeating variety produced by OSCILLATORS 1 and 4.

In addition to this variety where the variation occurs as long as a key is depressed, we can cause the pitch to sweep up and/or back down once for each key depression.

This type of change can be produced by ENV 1 or through patching, ENV 2.

An ENVELOPE is a varying voltage that increases when a key is depressed and continues rising until it reaches its maximum size. The amount of time it takes to reach this size is called the attack time and is adjusted with the ENVELOPE GENERATOR'S ATTACK pot.

After reaching its maximum size, it decays to its SUSTAIN level. The time taken to reach this level is determined by two factors:

1. How far the SUSTAIN level is from the ATTACK peak.
2. The setting of the DECAY pot.

If the SUSTAIN level is set midway, the ENVELOPE attacks, decays to the SUSTAIN level and remains there until the key is released. Upon release, it completes its decay. See ENVELOPE A.

If the SUSTAIN ON/OFF is OFF, the ENVELOPE would return instantly to zero upon release of the key. See ENVELOPE B.

For example, if the SUSTAIN level is set to zero, the ENVELOPE returns to its starting point at the DECAY rate producing ENVELOPE C.

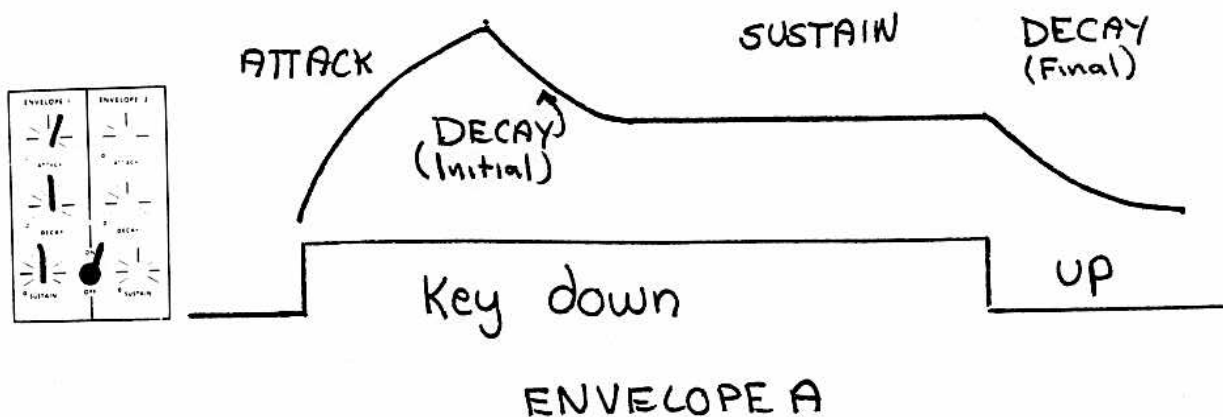

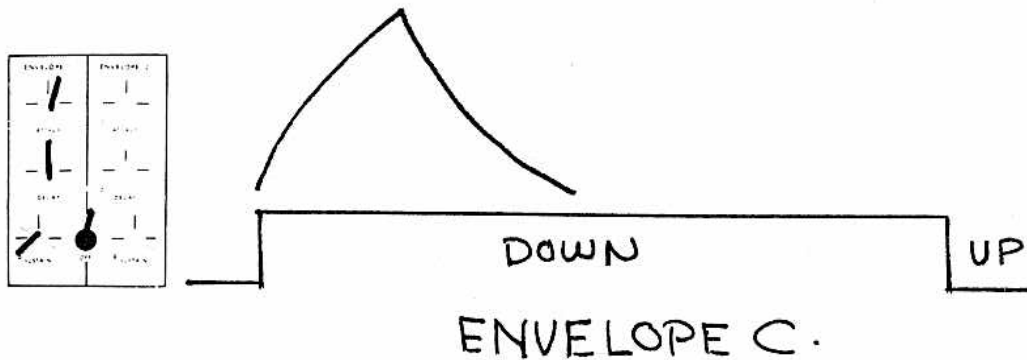
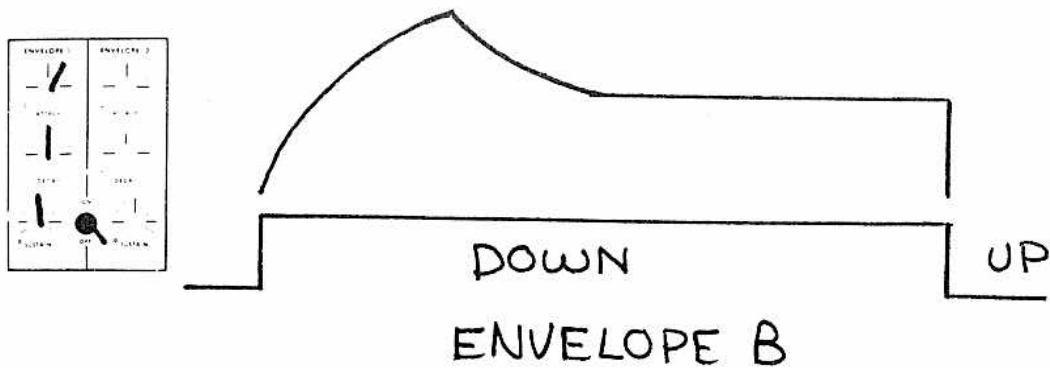

Using the setting shown below use ENV 1 to control the pitch of OSCILLATOR 2.

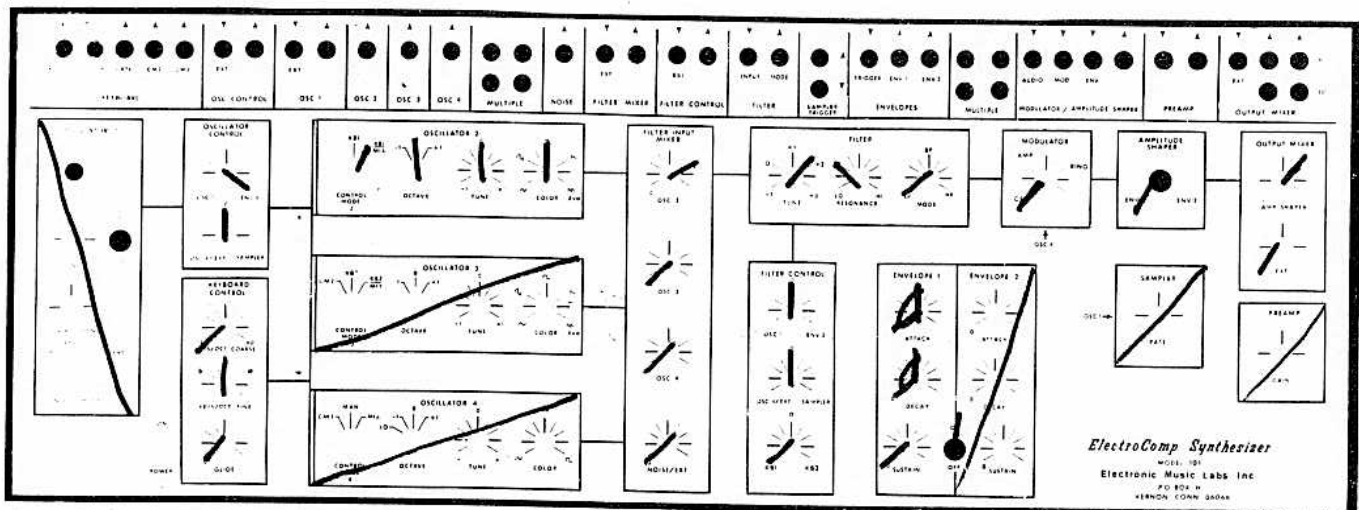

Using the settings shown above, you should hear a correlation between ENVELOPE shape and pitch change.

Also realize that ENV 1 and OSC 4 could be used simultaneously to vary the pitch of OSC 2. Try this!

REMEMBER -

1. THE AMOUNT OF CHANGE IS DETERMINED BY THE OSCILLATOR CONTROL MIXER'S ENV 1 POT.
2. THE SHAPE OF THE CHANGE BY THE ATTACK, DECAY AND SUSTAIN CONTROLS.
3. THE ATTACK CONTROL DETERMINES THE TIME IT TAKES TO REACH MAXIMUM ENVELOPE SIZE.
4. THE DECAY CONTROL DETERMINES THE TIME IT TAKES TO RETURN TO THE ENVELOPES STARTING POINT ASSUMING ZERO SUSTAIN LEVEL.
5. THE SUSTAIN LEVEL IS A STOPPING POINT FOR THE DECAY, WHERE THE ENVELOPE STAYS CONSTANT UNTIL THE KEY IS RELEASED.
6. IF THE SUSTAIN SWITCH IS ON, THE ENVELOPE CONTINUES ITS DECAY TO THE ENVELOPES STARTING POINT ON KEY RELEASE.
7. IF THE SUSTAIN SWITCH IS OFF, THE ENVELOPE INSTANTLY RETURNS TO THE ENVELOPES STARTING POINT ON KEY RELEASE.

The third type of pitch change that the OSCILLATOR CONTROL MIXER can produce is generated by the SAMPLER.

The SAMPLER can cause OSCILLATOR 2's pitch to vary in random or ordered sequences.

The SAMPLER is a circuit with two inputs. One comes from OSC 1. The other from a built-in rate oscillator.

From these two inputs it produces an output that is related to both of its inputs.

Assume the following:

1. OSCILLATOR 1 is producing a triangle wave that repeats once a second.

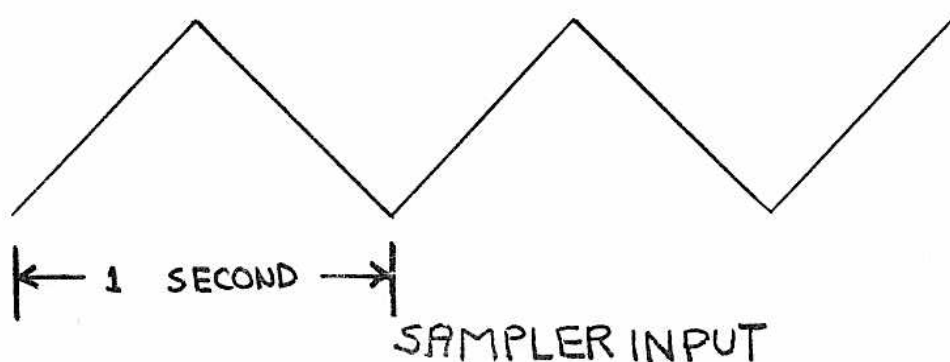

- The SAMPLER's rate control is running at 8 times second.

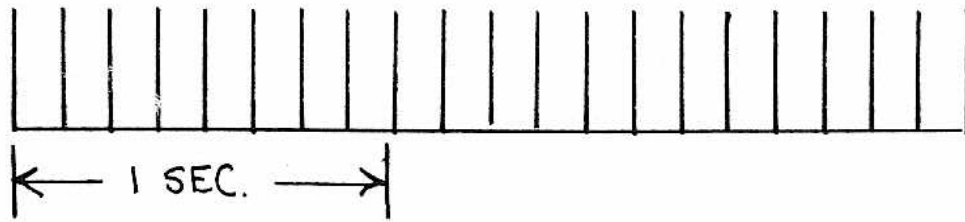

As an output you get a voltage that changes 8 times per second.

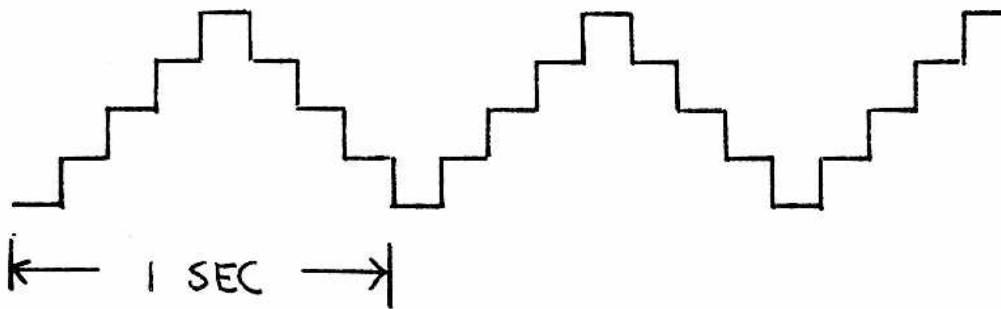

SAMPLER OUTPUT

The SAMPLER'S output causes the pitch of the OSCILLATOR to jump from one level to the next producing a series of pitches that increase and decrease.

Try the setting below. Use the OSCILLATOR CONTROL MIXER'S upper and lower pots to move between the SAMPLER output and OSC 1's triangle output.

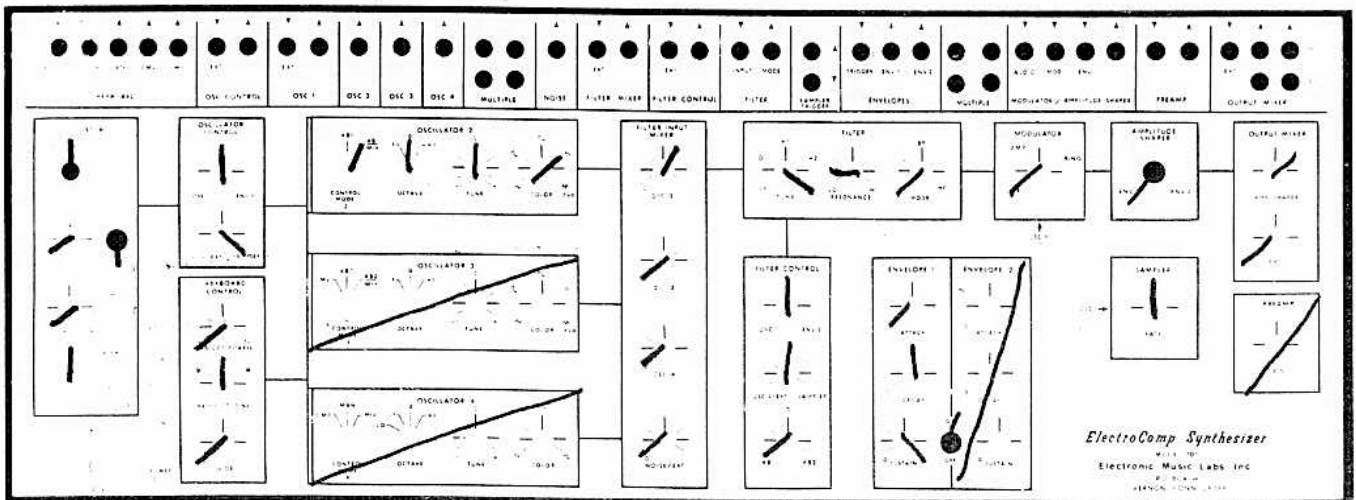

Try changing the waveform of OSCILLATOR 1 to either of the SAWTOOTH WAVEFORMS. Try drawing a picture of what is happening. (Don't change OSC 1's TUNE control.)

To this point, you have been producing ordered patterns (i.e. the pitch has been changing somewhat predictably). It's also possible to produce random patterns. To do this move OSC 1's HI/LO switch to the HI position. Adjust the TUNE CONTROL of OSC 1 slightly until you hear random patterns.

Take a look at this picture and see if you understand why the pattern is random.

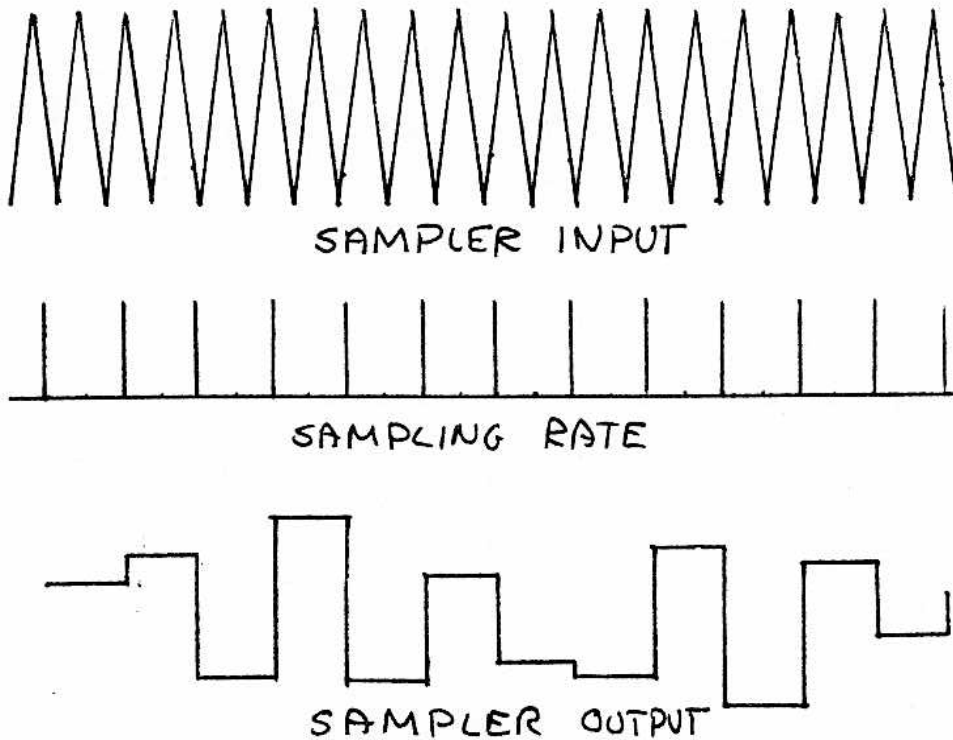

Variations in the SAMPLER's rate control will also change the randomness of the pattern.

REMEMBER -

1. THE SAMPLER CAN BE USED TO CONVERT THE SMOOTH OUTPUT OF OSC 1 TO AN OUTPUT WITH STEPS IN IT.
2. THESE STEPS CAN BE ORDERED OR RANDOM.
3. WHEN CONNECTED TO OSC 2 THROUGH THE OSC CONTROL MIXER THEY PRODUCE PROPORTIONAL CHANGES IN PITCH.

MIXERS.

Mixers are used to select and combine electrical signals within the synthesizer.

A common example of a mixer is a hot and cold water faucet. With its two controls you can select either hot or cold or a combination of both.

To this point you have been using the FILTER INPUT MIXER. This mixer permits you to control the volume of OSC 2, OSC 3 and OSC 4 before their outputs enter the FILTER for modification.

In addition, a fourth control labeled NOISE/EXT permits the introduction of external sound sources or noise. (Noise will be covered in a subsequent paragraph.)

As you've heard, the FILTER INPUT MIXER is primarily used to blend the sound sources of the synthesizer.

As an example, set the patch shown below. Open each control of the FILTER INPUT MIXER.

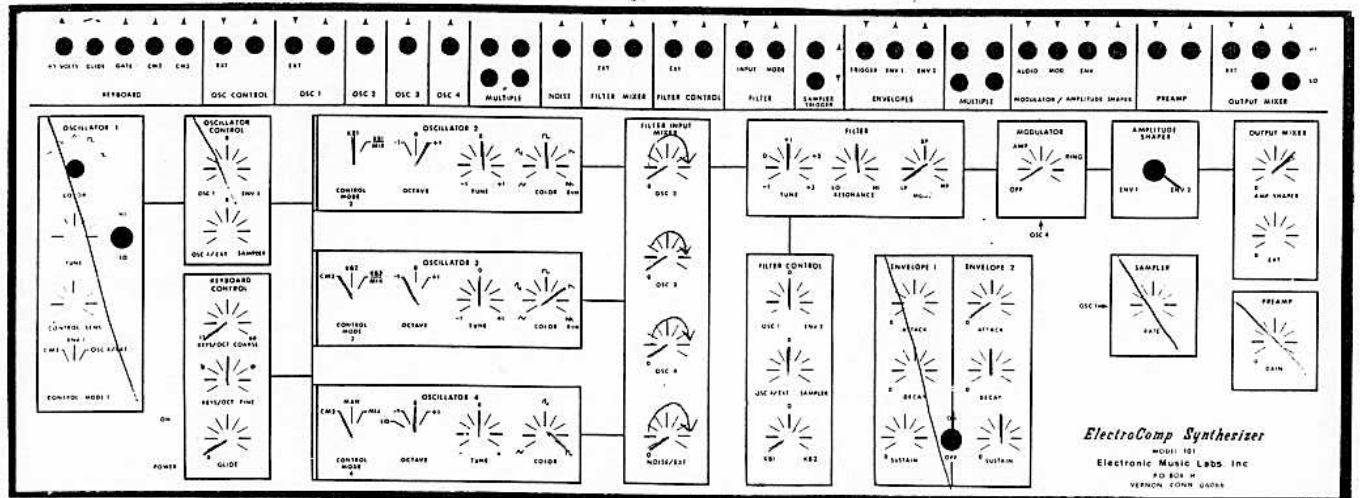

FILTER.

The FILTER is used to control the timbre of the sound.

Timbre is determined by the relative loudness of the overtones within the sound.

By overtones, we are referring to additional pitches which are present within every sound. (Only a sine wave does not have overtones.)

To prove the presence of overtones within a single pitch, set the 101 as shown below. Depress a key and slowly rotate the FILTER's TUNE control clockwise.

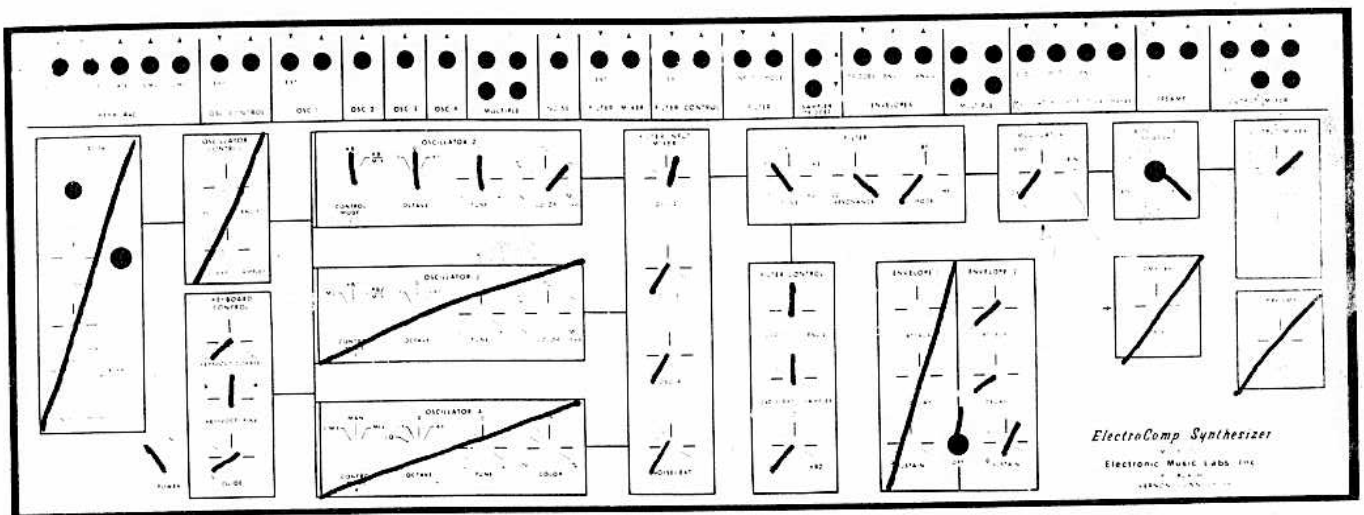

DEPRESS LOW F

Before turning the TUNE control you should hear a pitch, called the fundamental, which is exactly the pitch you would expect from the key depressed.

As the key is rotated clockwise you should hear the fundamental fade out, and be replaced by a pitch which is up an octave from the fundamental.

Continued rotation will produce a pitch up an octave and a fifth, and then one up two octaves, and so on.

The important thing to realize is that you are not changing the basic pitch, but rather using the FILTER to discover the overtones present in the sawtooth waveform of OSC 2 which is going into the FILTER by way of the FILTER INPUT MIXER.

By rotating the TUNE control clockwise, you are moving the FILTER's window higher and higher in frequency.

By having the FILTER's RESONANCE control set at its highest position, the FILTER has a very narrow window, and therefore you hear only one overtone at a time.

These diagrams show what you've heard. Below is a graph of the fundamental and the first 7 overtones of a sawtooth. (A sawtooth actually has additional overtones of higher frequency, but are not necessary for explanation.)

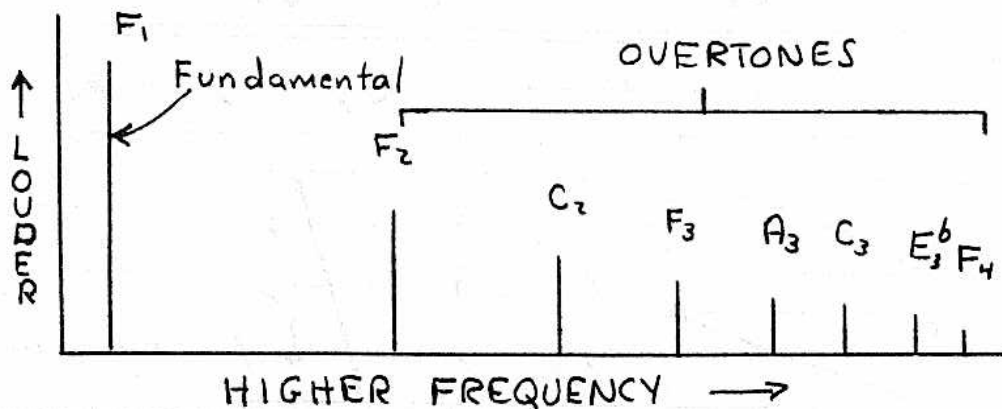

As you started, the FILTER was passing mostly the fundamental and rejecting all other overtones.

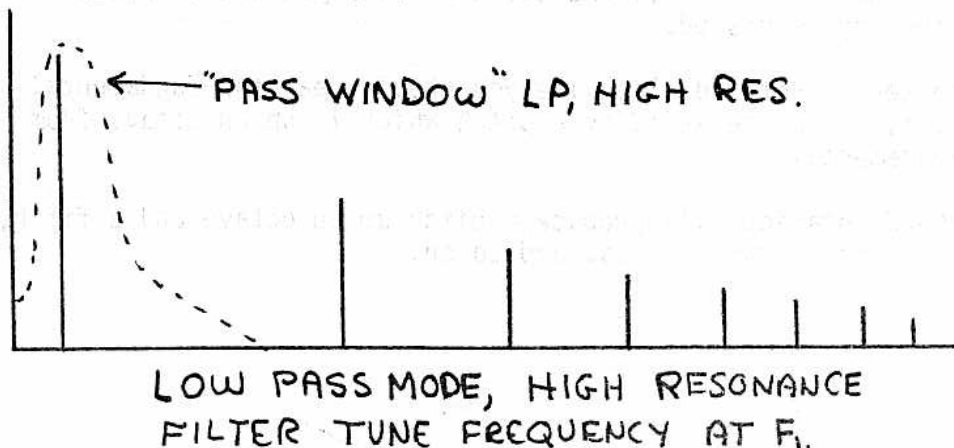

Rotation of the FILTER TUNE control up an octave.

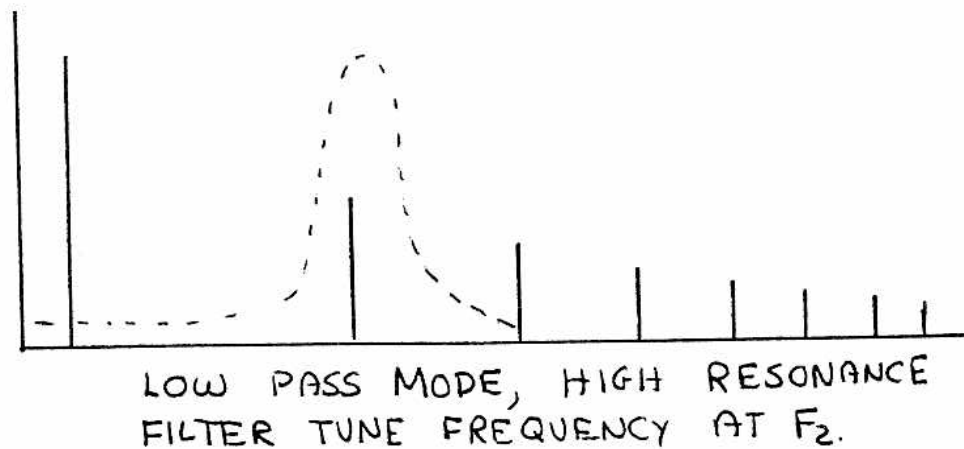

Further rotation progressively moved this window from one overtone to the next.

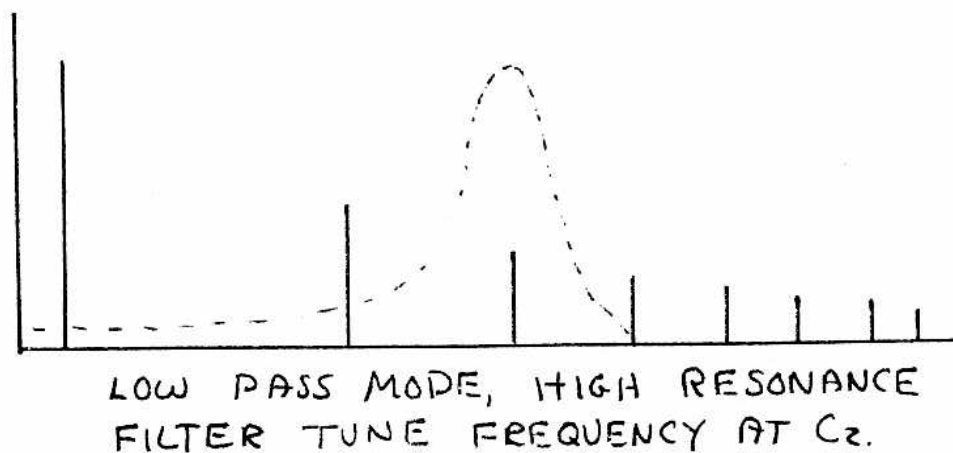

LOWERING THE FILTER'S RESONANCE CHANGES THE SITUATION. Set the RESONANCE at 1 o'clock. Depress a key and rotate the TUNE control slowly clockwise.

You should hear the sound become progressively brighter and no longer hear the overtones individually.

What's happening is this! The RESONANCE is low and the window is now shaped differently.

Since the FILTER is in the LOWPASS (LP) MODE, all overtones below the FILTER's TUNE frequency are passed through to the output.

These diagrams show what happens with clockwise rotation.

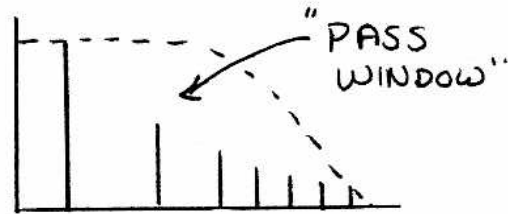
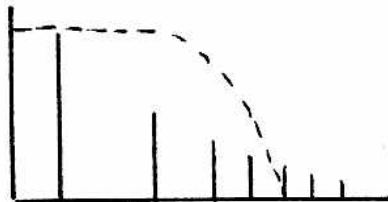
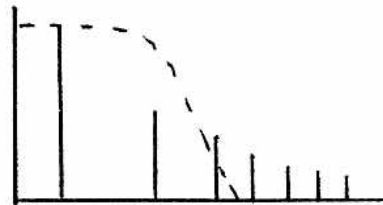
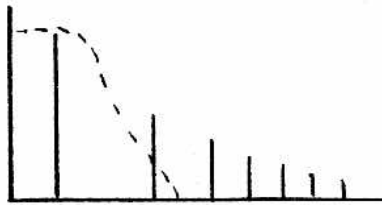

LOW PASS, LOW RESONANCE

Repeat the previous experiment, but this time put the FILTER in the HIGH PASS (HP) MODE.

As the FILTER's TUNE control is rotated clockwise, you should hear the lower overtones disappearing. These diagrams show what happens in the HIGH PASS MODE.

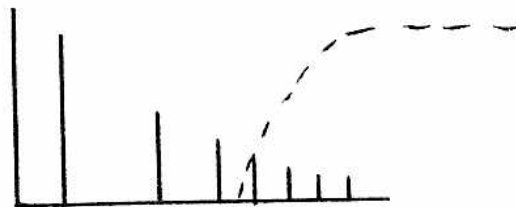
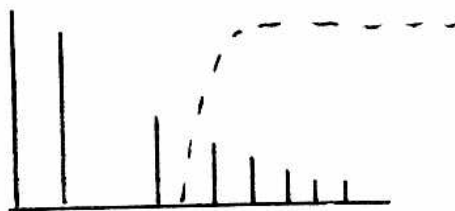
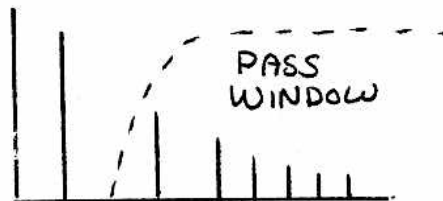
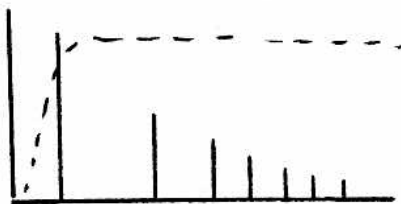

HI PASS, LOW RESONANCE

In the BAND PASS MODE, the FILTER passes only those frequencies on either side of the frequency set by the FILTER's TUNE control. The width of the BAND is determined by the RESONANCE control.

These diagrams show what happens in the BAND PASS MODE.

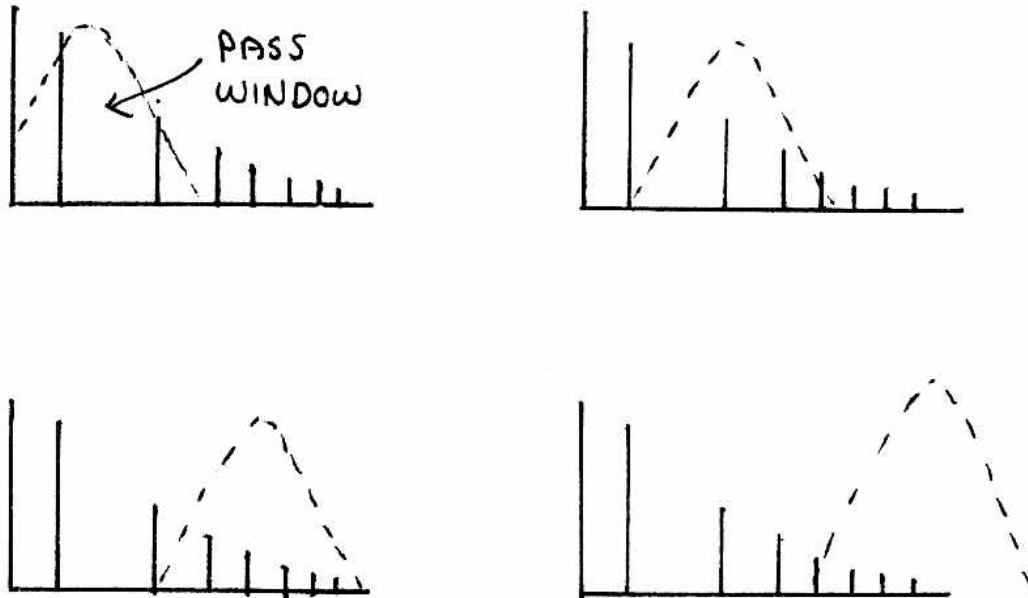

BAND PASS, LOW RESONANCE

You should note that when the RESONANCE is set high, the LP, BP, and HP MODES are very similar, though not identical.

When the RESONANCE is high, the FILTER actually increases the loudness of any overtone located near the FILTER frequency.

REMEMBER -

1. THE FILTER'S TUNE CONTROL DETERMINES WHERE THE FILTER BEGINS PASSING AND REJECTING OVERTONES, OR FOR THAT MATTER ANY PITCHES PUT INTO IT.
2. THE RESONANCE CONTROL DETERMINES HOW MUCH THE OVERTONES NEAR THE FILTER'S TUNE FREQUENCY WILL BE STRENGTHENED.
3. THE MODE CONTROL DETERMINES WHAT HAPPENS TO THE OVERTONES ABOVE, BELOW OR AROUND THE FILTER'S FREQUENCY.

To this point, you have been operating the FILTER'S TUNE control manually. This portion of the FILTER can be voltage controlled.

Set the 101 as shown below. Depress a key.

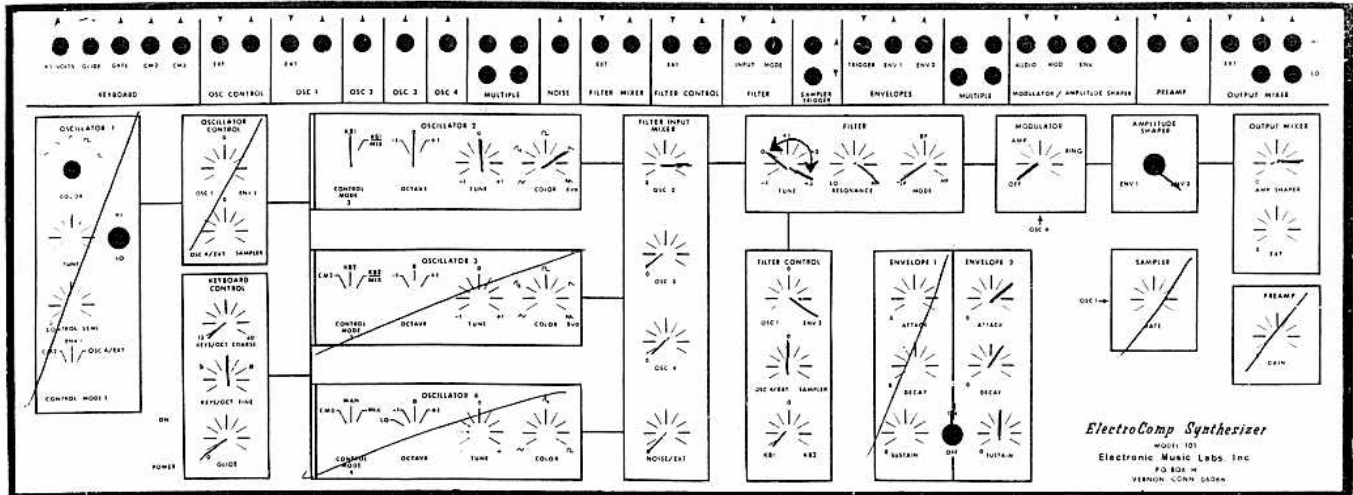

The FILTER's frequency is being increased by ENV 2. You can verify this by turning the upper control of the FILTER CONTROL MIXER to zero and depressing a key.

Of course, the position of ENV 2 in the FILTER CONTROL MIXER determines how much the FILTER's frequency will move.

The shape of the motion is determined by the settings of ENV 2's ATTACK, DECAY and SUSTAIN controls.

Vary ENV 2's controls. Try different settings of FILTER TUNE, RESONANCE and MODE with each ENVELOPE setting.

Also don't hesitate to try the square wave of OSC 2 in place of the sawtooth.

The FILTER is by far the single most important part of any synthesizer. Experiment freely and often.

In addition to ENV 2 the FILTER CONTROL MIXER contains OSC 1, OSC 4 and the Sampler similar to the OSCILLATOR CONTROL MIXER.

Various settings of OSC 1 and FILTER controls produce excellent

effects. Try both the settings shown below. Do not hesitate to vary the controls of OSC 1.

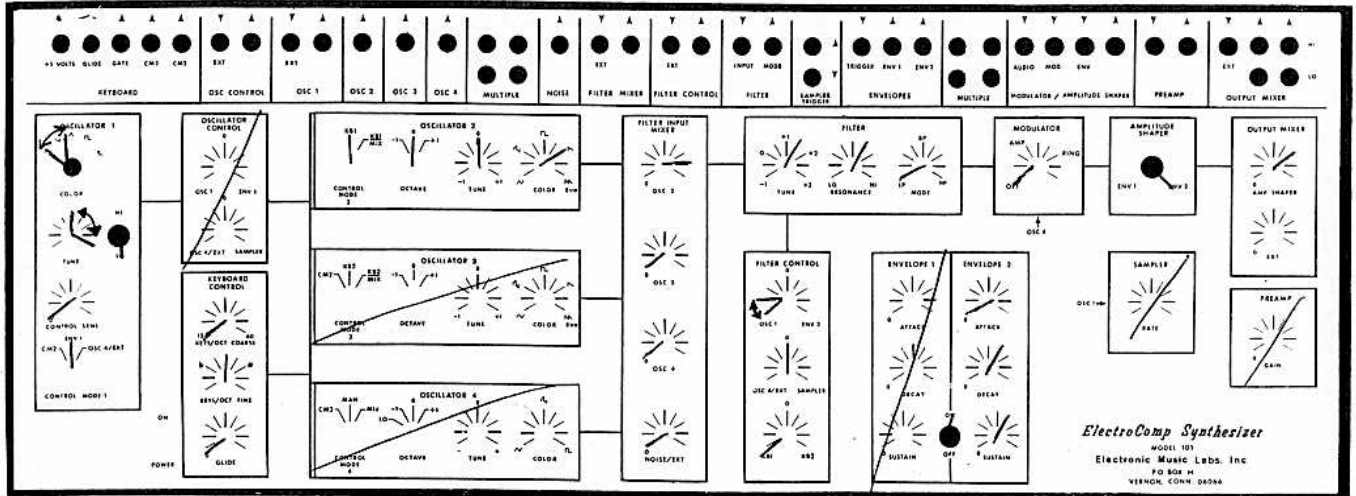

STRUM

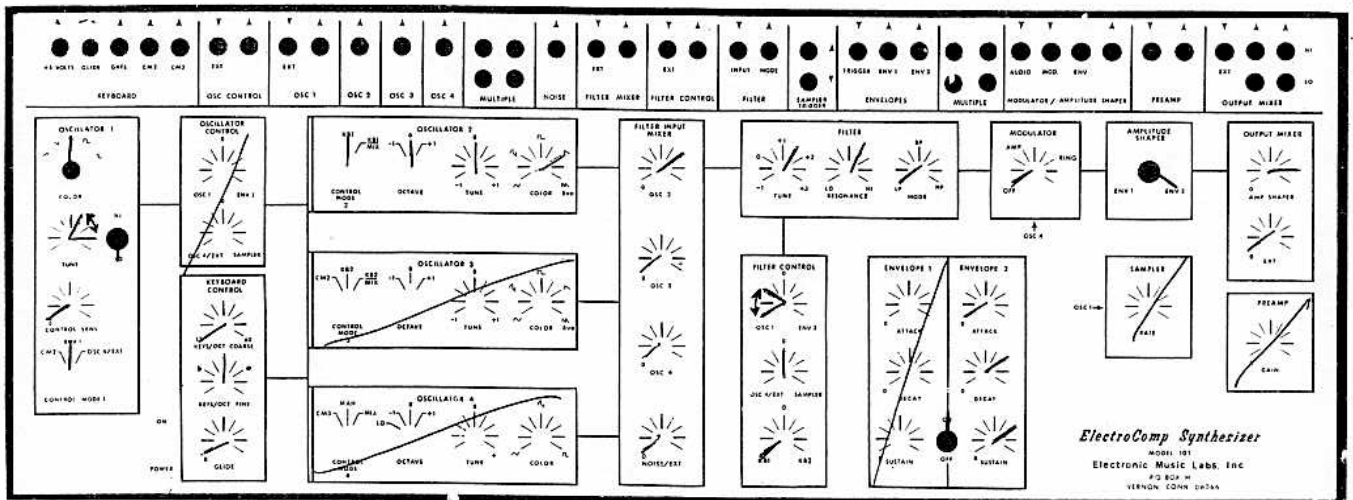

REPEATING WAH

The lower control of the FILTER CONTROL MIXER determines the effect of the KEYBOARD on the FILTER.

When this control is set full counter clockwise, the timbre remains constant across the KEYBOARD. If this control is rotated towards zero, the timbre will become duller with increasing KEYBOARD position.

If the filter is in the LP MODE, and you are using the two note capabilities of the KEYBOARD, the lowest control (this is the filter tracking control) should be turned clockwise and set on KB2. In the HP mode and using the 2 note capability this filter tracking control should be set to KB1.

An interesting result of being able to control the FILTER from either key is found in one note situations. Using OSC 2 as a pitch source, the timbre can be controlled by the upper key, and the pitch by the lower key. Set the synthesizer as shown below.

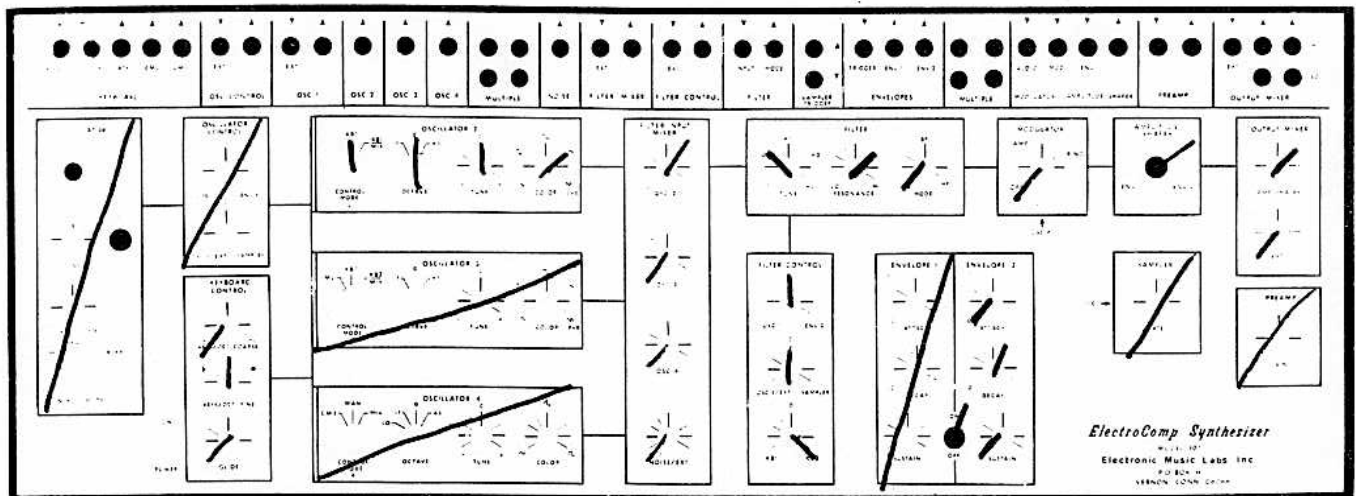

Hold low F down and gradually depress higher and higher keys with your free hand. Try this with both low and high RESONANCE. (In high RESONANCE note the positions of the overtones.)

NOISE GENERATOR

The 101's NOISE GENERATOR produces WHITE NOISE. WHITE NOISE is named thus because, as in white light, it contains any or all pitches at any instant.

Pink noise is actually LO PASS, LOW RESONANCE filtering of WHITE NOISE and may be realized on the 101.

In addition many other varieties of noise can be achieved by using the many MODES of the 101's FILTER.

Try the two settings shown below. Don't hesitate to vary the shape of the ENVELOPE GENERATORS or to use ENV 2 of the FILTER CONTROL MIXER.

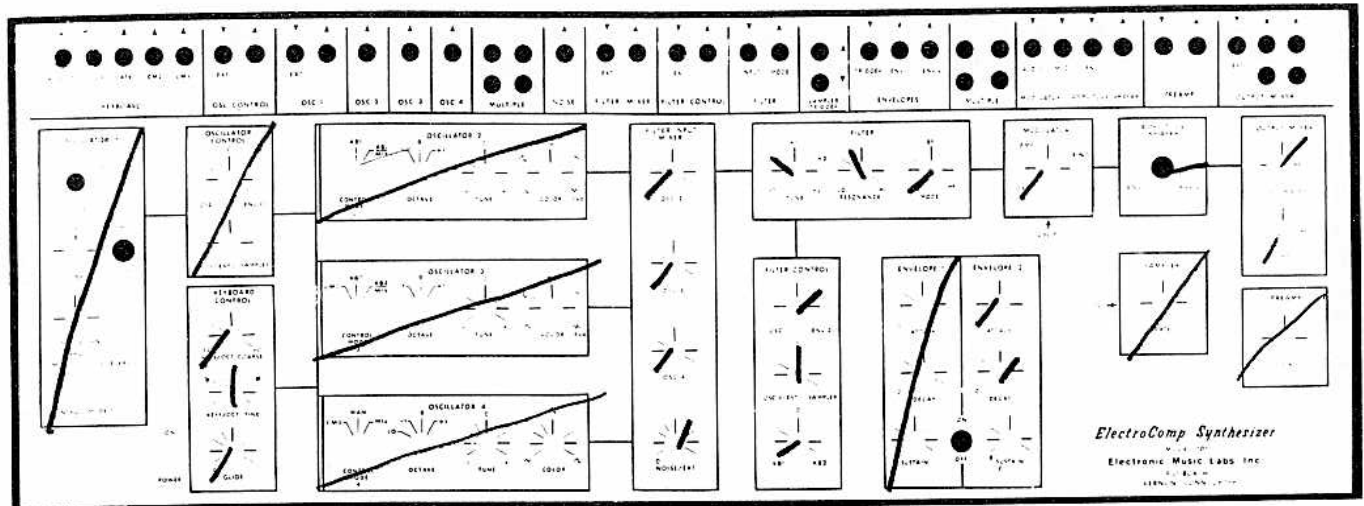

LOW PASSED NOISE

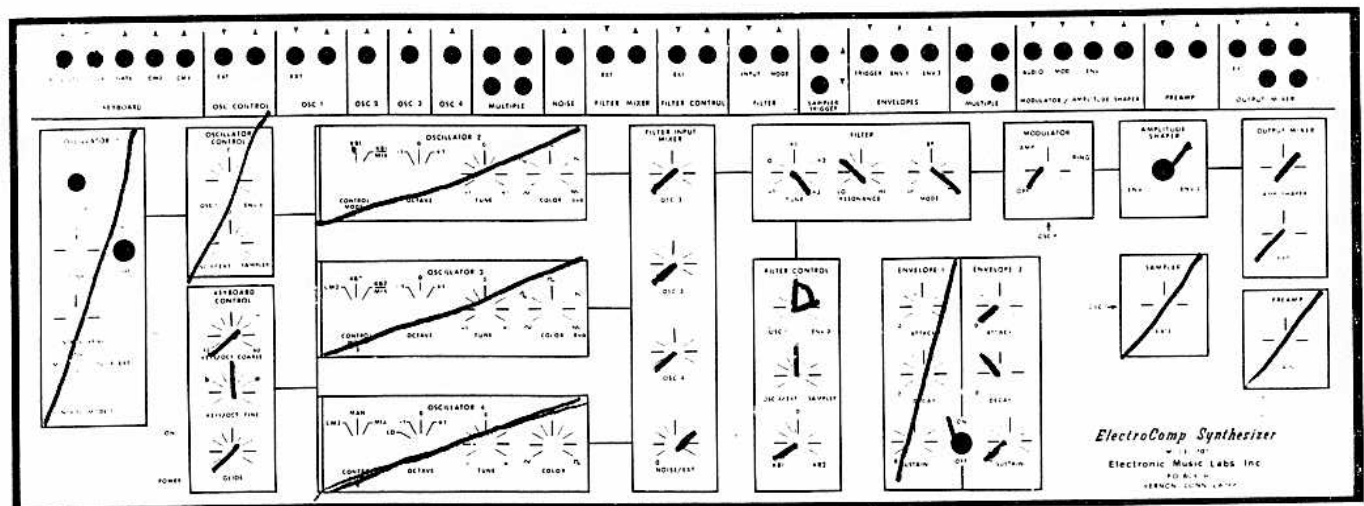

HIGH PASSED NOISE

BASIC RULES FOR USING THE FILTER.

1. The audio oscillator volume controls in the FILTER INPUT MIXER should be turned up at least halfway.
2. The FILTER frequency must be tuned above or equal to the OSCILLATOR in the LOWPASS MODE. (If the FILTER is tuned below the OSCILLATOR, there will be no sound for the FILTER to pass.)
3. The volume controls of the OUTPUT MIXER should be turned up at least halfway. Simply keep the volume levels in the synthesizer as high as possible and use the volume control of your amplifier to set a suitable listening level.
4. FILTER MAINTENANCE - After every 100 hours of operation apply a sine wave to the output of the FILTER to back flush the trapped overtones to unclog your filter.

(Please note the previous paragraph is the one in-
tentional joke in the manual.)

THE MODULATOR.

The MODULATOR is used to produce the exotic textures of ring modulation and various types and rates of tremolo.

Experiment with it freely and at length. Note that it combines two signals - one from the FILTER, the second from OSCILLATOR 4.

TREMOLOS.

Set the 101 as shown below. As you turn the MODULATOR pot clockwise from the OFF position, you will hear a variation in loudness. The speed of these may be varied by changing the TUNE pot of OSCILLATOR 4, as well as by the MODULATOR pot.

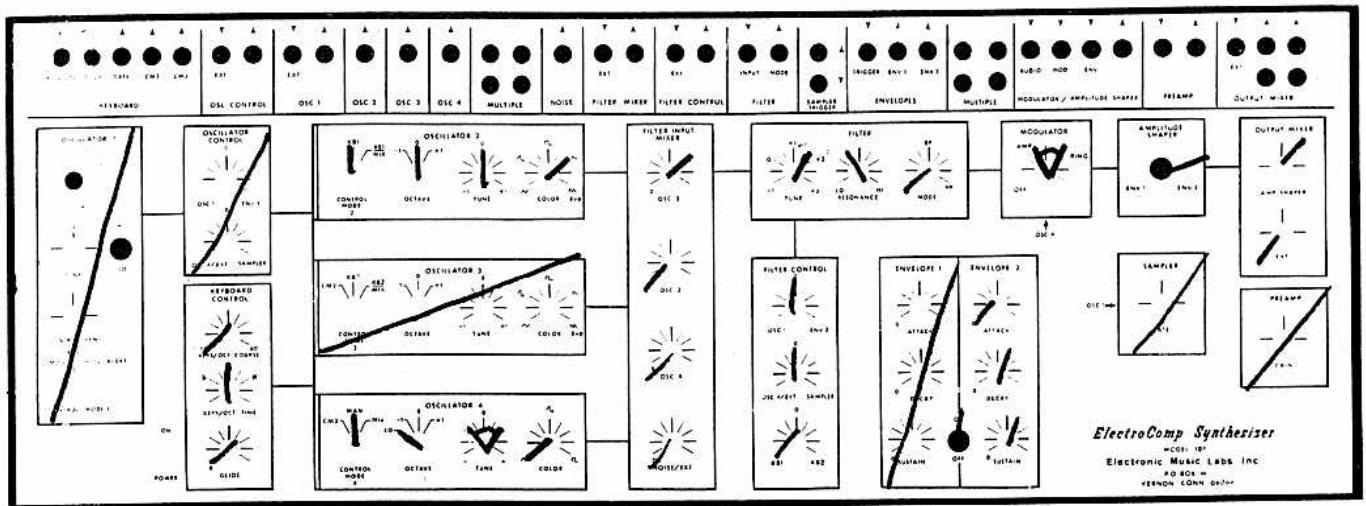

TREMULO

As you rotate the MODULATOR control you should note that at some point the rate of amplitude variation doubles. This is the "ring modulation" position.

Switch OSCILLATOR 4's MODE to CM 3. Note that the rate is now directly related to pitch.

RING MODULATION.

Normally RING MODULATION occurs at audio frequencies. Set the

101 as shown below to produce chime like sounds.

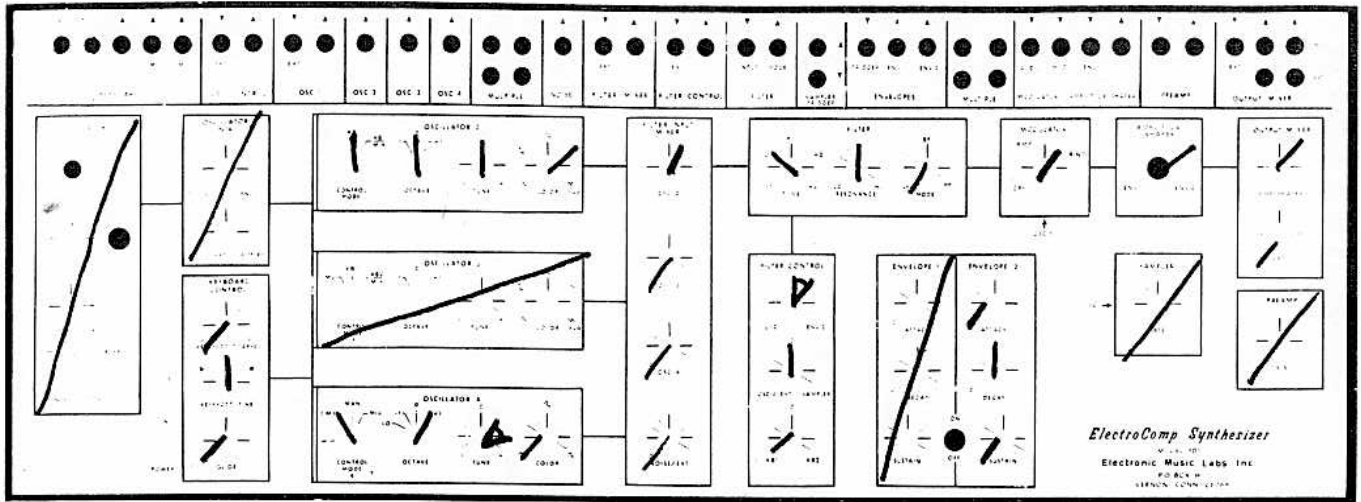

RING MODULATION

While playing the upper octave of the keyboard quickly rotate this control between the AMPLITUDE and RING positions.

Also experiment with the unusual textures available when OSC 4 is not moving in parallel to the KEYBOARD, i.e. when OSC 4 is in the MANUAL mode.

AMPLITUDE SHAPER.

You probably have not given much thought to the fact that when you pressed a key you got a sound, and that when you released it, the sound stopped. If we were to draw a graph of that sound, it might look like this:

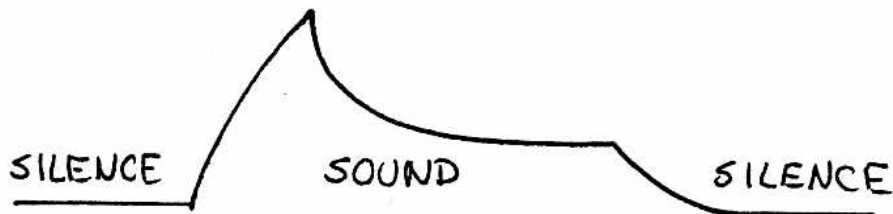

This effect is the result of an ENVELOPE GENERATOR controlling the AMPLITUDE SHAPER.

The AMPLITUDE SHAPER has two inputs. One is the output of the FILTER which occurs as long as the synthesizer is turned on and there is an input to the FILTER. The second is the output of either ENVELOPE GENERATOR which occurs when a key is depressed.

The AMPLITUDE SHAPER is controlled by either ENVELOPE 1 or 2, depending on its switch setting. It is an amplifier (a device that controls loudness) and it is voltage controlled.

If you recall, both the oscillators and the filter are voltage controlled. In those cases, voltage affected pitch or timbre.

In the case of the AMPLITUDE SHAPER, voltage affects the loudness of the sound passing through.

As proof, set OSCILLATOR 4 in the Manual mode, in -1 octave, and tuned to 0. Turn off all other sources in the FILTER INPUT MIXER. Set the FILTER'S TUNE at its highest setting and put its MODE in LP. Take a patch cord and patch from CM 2. to MODULATOR/AMPLITUDE SHAPER ENV on the jack panel.

Play the keyboard.

Note that the KEYBOARD (and its voltages) now controls only the volume of the sound, with lower keys being softer and higher keys louder.

Set the 101 as shown below and experiment with various settings of the ENVELOPE GENERATOR.

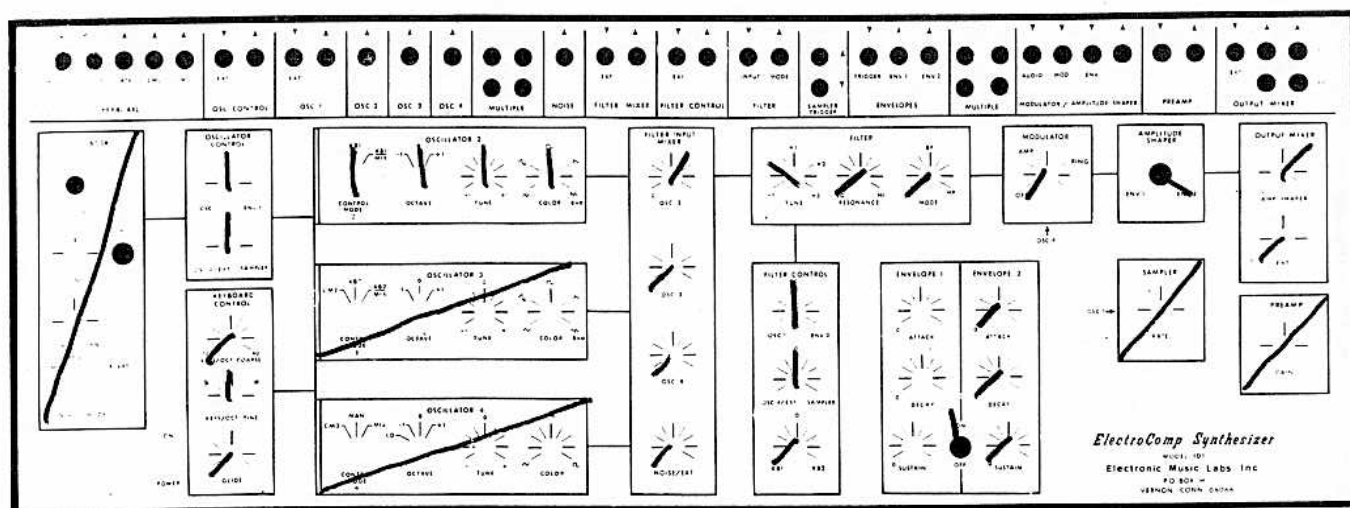

DEPRESS A KEY, INCREASE DECAY. REPEAT.

REMEMBER -

1. THE AMPLITUDE SHAPER IS A VOLTAGE CONTROLLED AMPLIFIER.
2. ANY SOUND INPUT TO IT WILL CHANGE IN LOUDNESS IN DIRECT PROPORTION TO VOLTAGES CONNECTED TO ITS MODULATION INPUT.

Of course, the two ENVELOPES can be set differently and selected as necessary to control the AMPLIFIER.

TUNING THE ELECTROCOMP 101.

In the introductory explanation of how to play the ElectroComp 101, we presumed for the sake of simplicity, that you were interested only in tempered tuning, and were not concerned about absolutely precise tune.

However, very great precision of tuning is possible, and various non-chromatic tuning possibilities exist. This section deals with these aspects of the synthesizer.

There are two aspects to tuning. The first has to do with getting the synthesizer KEYBOARD in tune with itself. The second has to do with tuning the synthesizer to other instruments.

In conventional Western music, the octave is divided into 12 equal parts.

To obtain this division of the octave with the synthesizer keyboard, turn the KEYS/OCT COARSE pot in the KEYBOARD CONTROL to 12 (fully counter-clockwise). In this position, the keyboard is approximately in conventional tune, with 12 keys per octave.

However, the octaves may not be quite exact.

For this reason, a KEYS/OCT FINE pot for fine tuning has been provided. Using this in the manner described, it will be possible to exactly tune your synthesizer to perfect octaves.

Set OSC 2 in KB1 position.

Set OSC 3 in KB2 position.

Playing the top G on the KEYBOARD, tune these two OSCILLATORS to a unison ("beats" should be occurring no more than once every three seconds).

At this point, the two OSCILLATORS are exactly in tune with each other.

Play the bottom F on the KEYBOARD. The two OSCILLATORS should still be in precise tune.

Now play both the bottom F (KB1) and the first F above it (KB2).

If the synthesizer is perfectly in tune for twelve notes per octave, these two Fs should be exactly in tune (no beating).

If the synthesizer is not playing exactly 12 notes per octave, then the upper F will be slightly out of tune with the lower one. Using the KEYS/OCT FINE pot, adjust the tuning until all beating ceases.

At this point, the synthesizer is playing very close to exactly 12 notes per octave.

However, more accuracy is desirable, as errors still may exist which are significant for multiple octave intervals.

Therefore, now play both the bottom F and uppermost F (3 octaves up) together. Re-adjust KEYS/OCT FINE until a beat free condition is obtained. At this point all errors are reduced to insignificance and the synthesizer is exactly and precisely in tune.

We suggest that you note the position of KEYS/OCT FINE and perhaps make a pencil mark for future reference. The adjustment is extremely stable and you may rely on it with a great deal of confidence. Periodic checks (every few months) are easily sufficient.

To obtain other tunings than the conventional 12 note per octave, use the KEYS/OCT COARSE pot.

For instance, suppose you want to play in "quarter-tones". In a quarter-tone system, there are 24 notes per octave. This means that the first octave F on the keyboard should sound B and the second octave F should sound the first F octave.

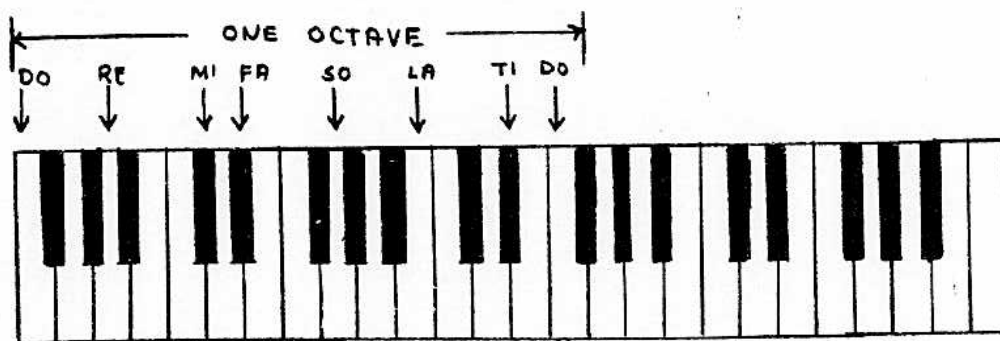

"quarter-tone" tuning

To obtain this tuning, simply play the bottom F and the second octave F together with the two perfectly tuned OSCILLATORS, and adjust the KEYS/OCT COARSE pot until a beat free octave is obtained. For this tuning, adjustment of KEYS/OCT FINE isn't really necessary, due to the reduced range of the KEYBOARD.

If you wish to experiment with different tunings, determine the number of notes per octave desired, count up that number of keys from the bottom key, add one, and tune to a perfect octave. Micro-tuning is available to 60 notes per octave, which gives the entire KEYBOARD a range of approximately a perfect fifth.

The limitations are that you cannot go to fewer than 12 notes/octave and that all intervals are going to be equal.

In order to tune OSCILLATORS to each other accurately, we suggest you do so toward the top of their range and the top of the KEYBOARD, as this is the area where errors in tuning become noticeable. In general tune in the top octave of the KEYBOARD, and then tuning to a unison, the top G is ideal.

Tuning to other instruments is now simple.

Tune one of the OSCILLATORS precisely to the ensemble, and then tune the other OSCILLATORS that will be used to the first OSCILLATOR.

Two tuning problems:

1. When switching octaves on some early synthesizers the octave change may not be exact. Retuning (very slight adjustments) may be desirable.
2. Similarly, when shifting OSC 3 from KB2 to CM2, a difference in tuning may be experienced, necessitating a slight retuning.

MISCELLANEOUS 101 SETTINGS.

The followign pages outline a few interesting patches. Some of these are only applicable to Serial number's 410 and up and are labelled to indicate this.

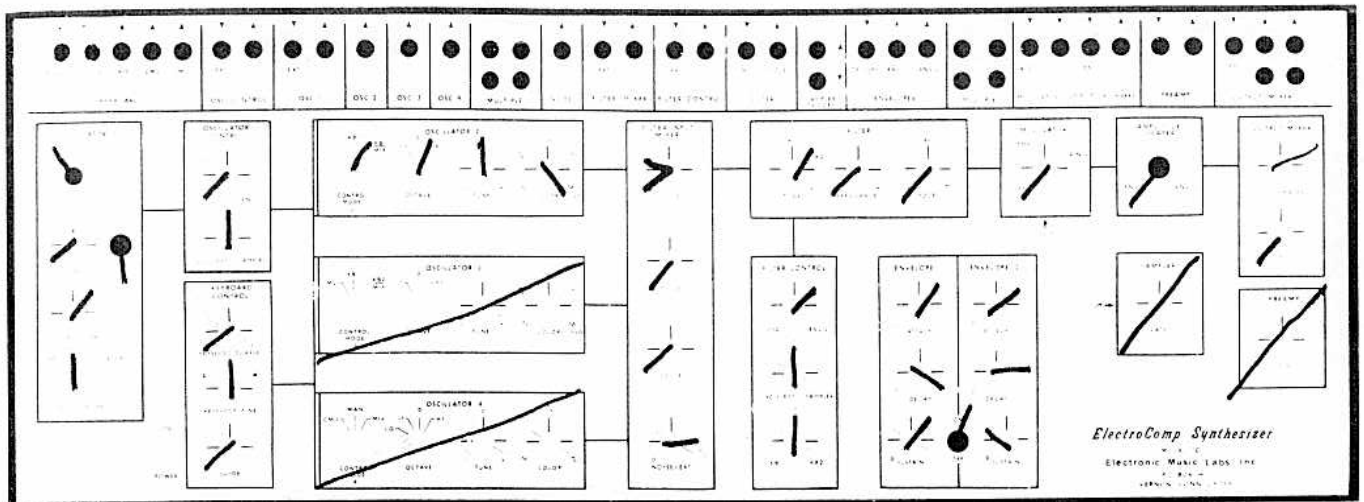

SEA WITH BIRDS

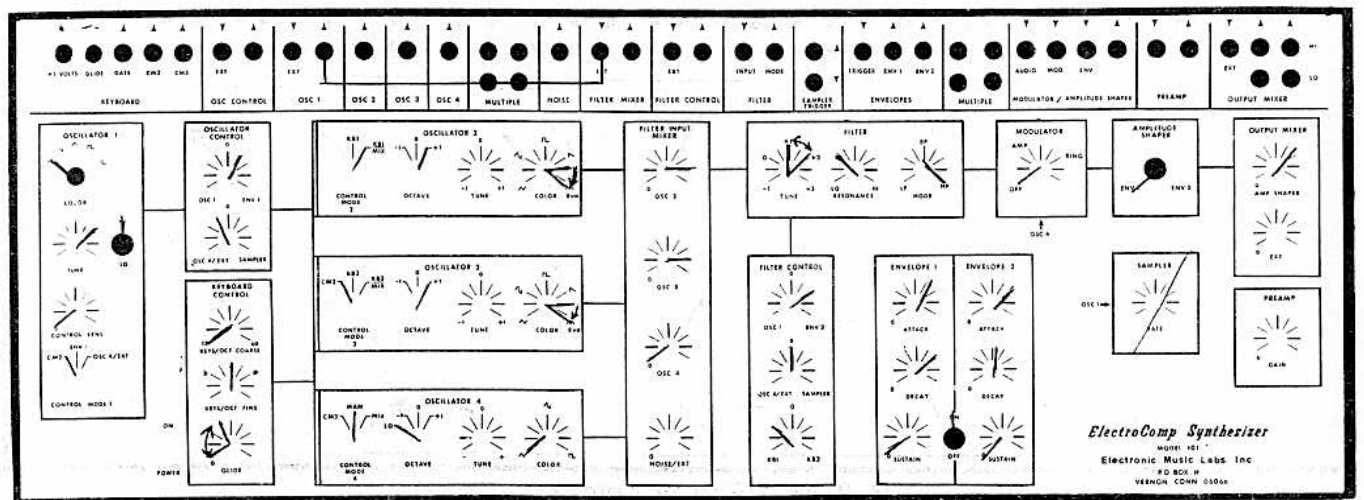

STRINGS

(Use high register & some reverb. Let envelopes work for you.)

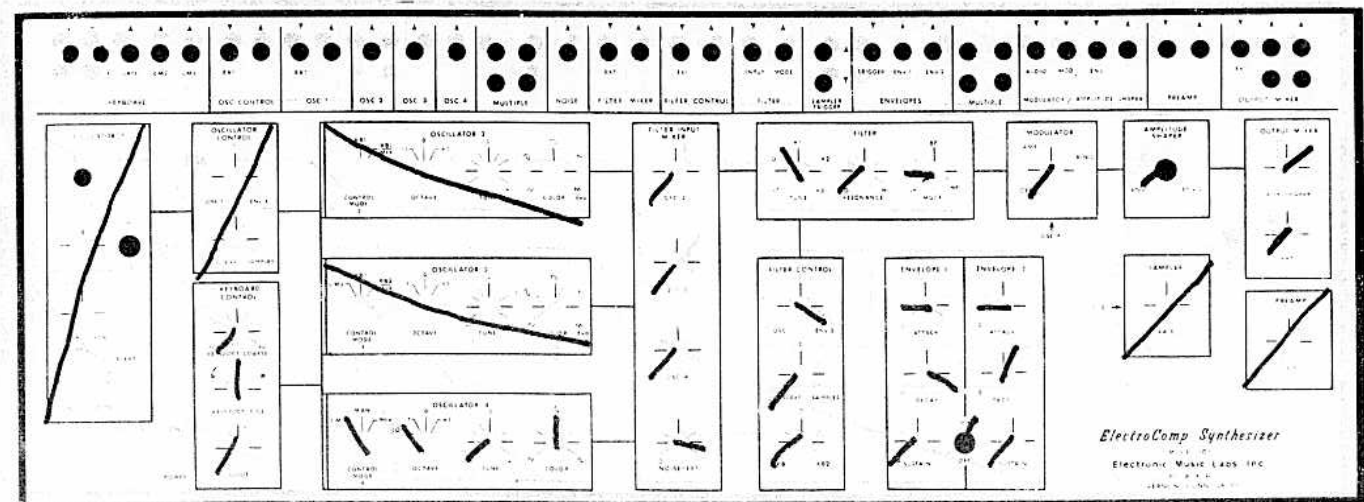

THUNDER

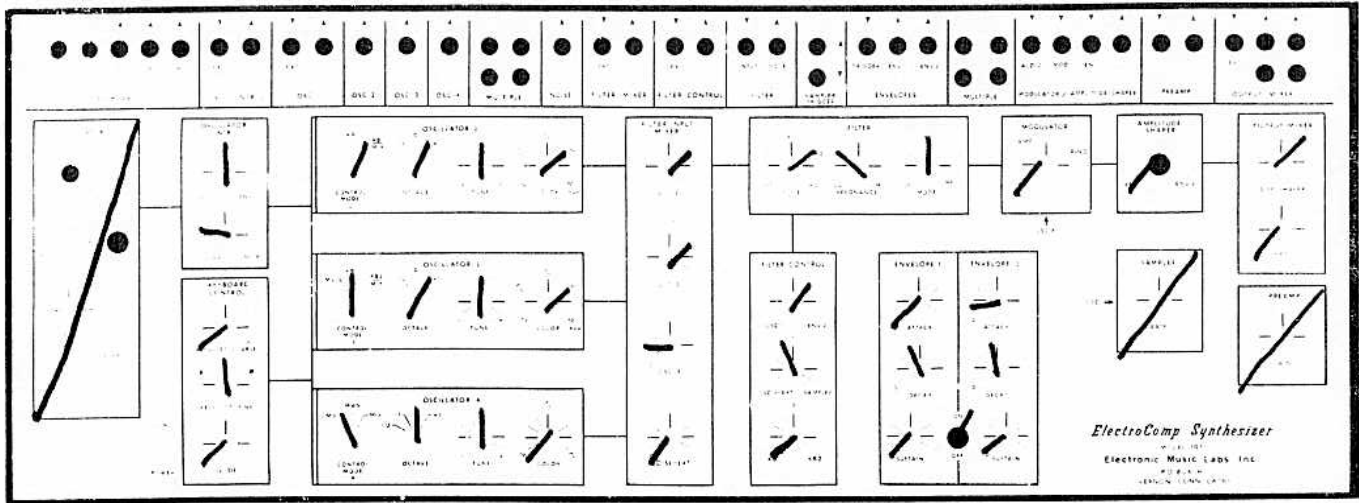

HARPSICORD (Use with some reverb.)

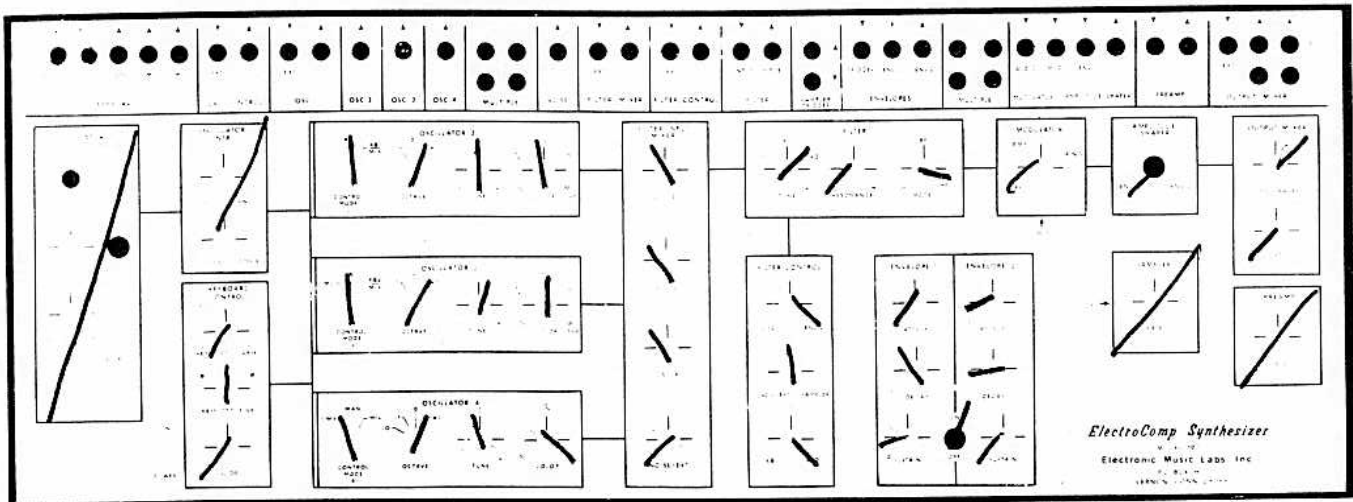

TOY PIANO (Top octaves)

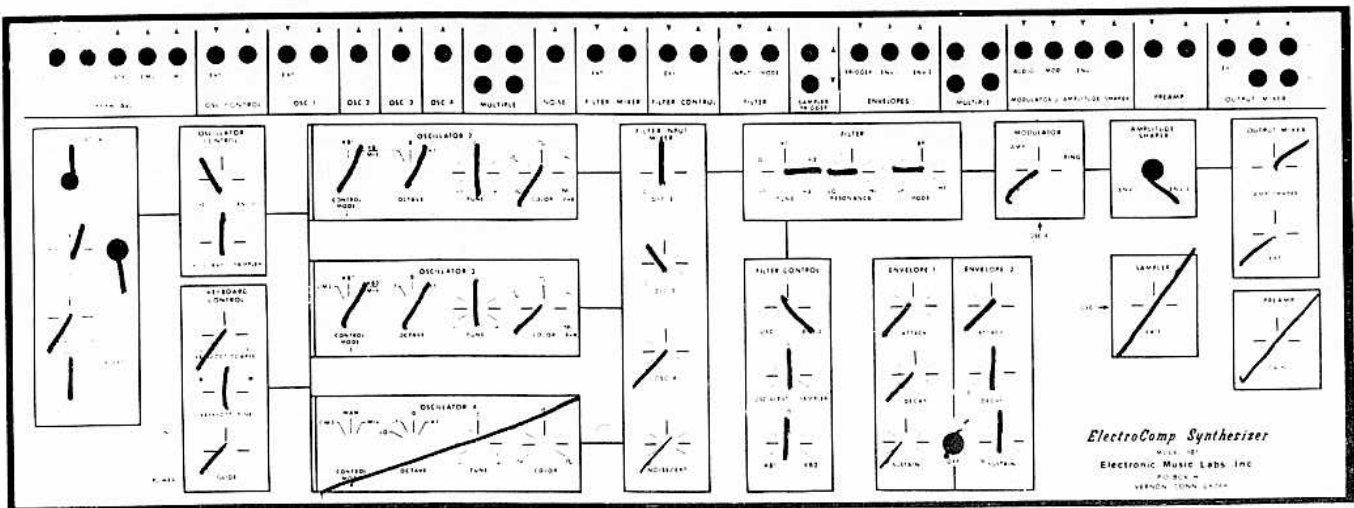

JAW HARP

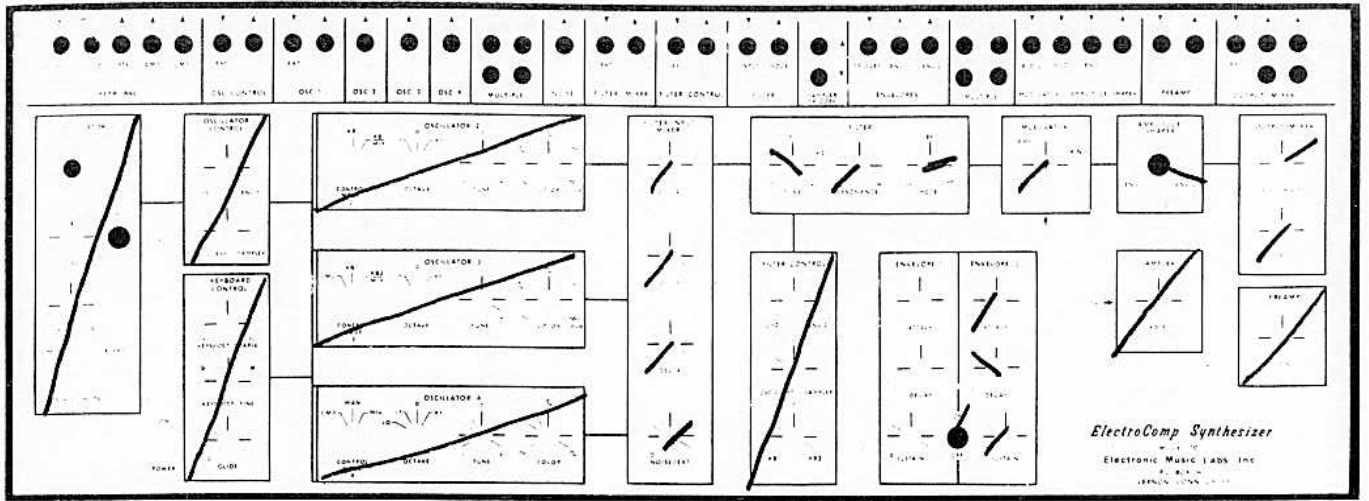

SNARE DRUM

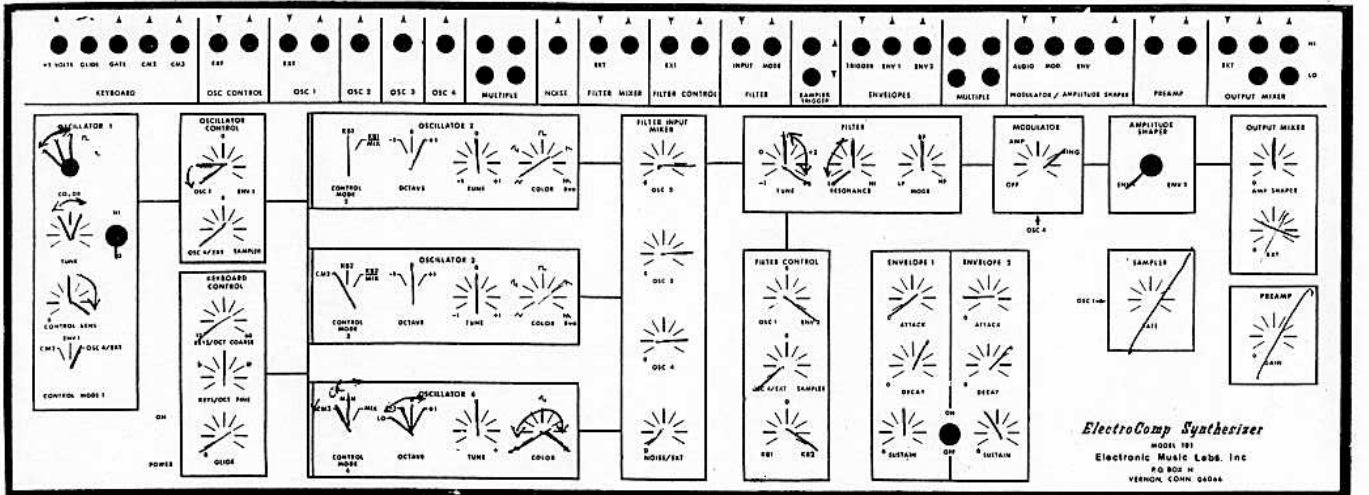

FANTASY #2

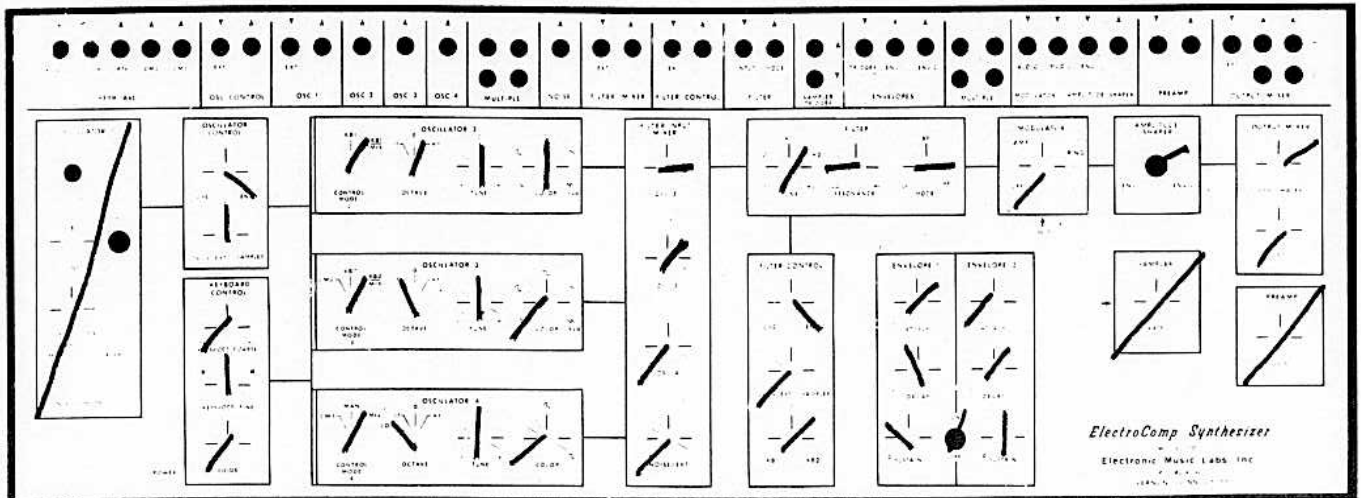

FANTASY #3

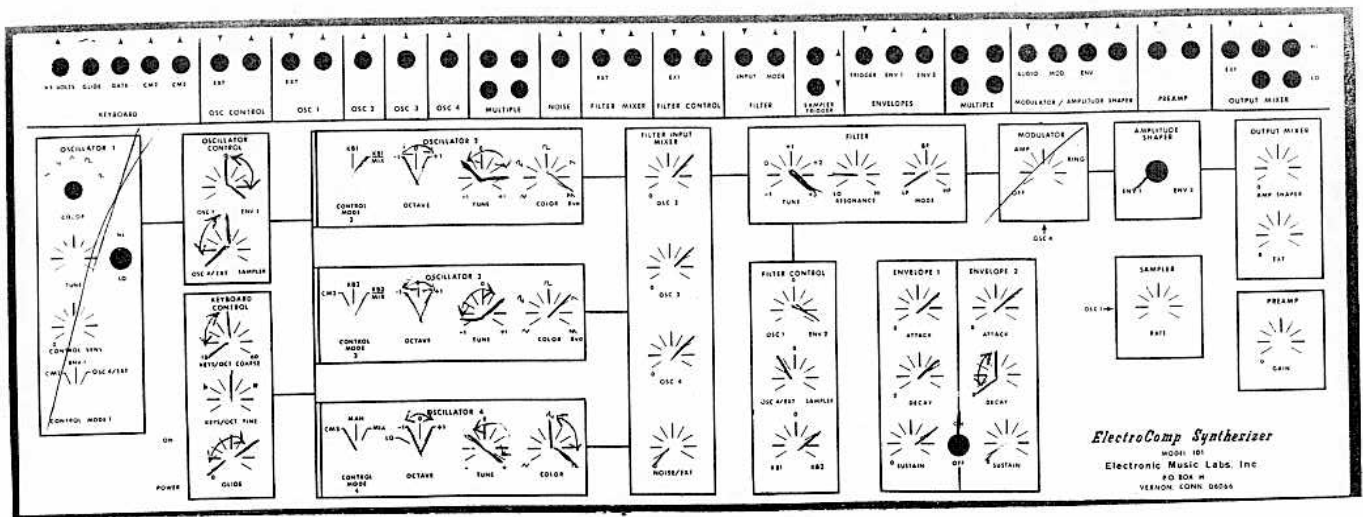

FANTASY #4

MICROPHONE ET AL

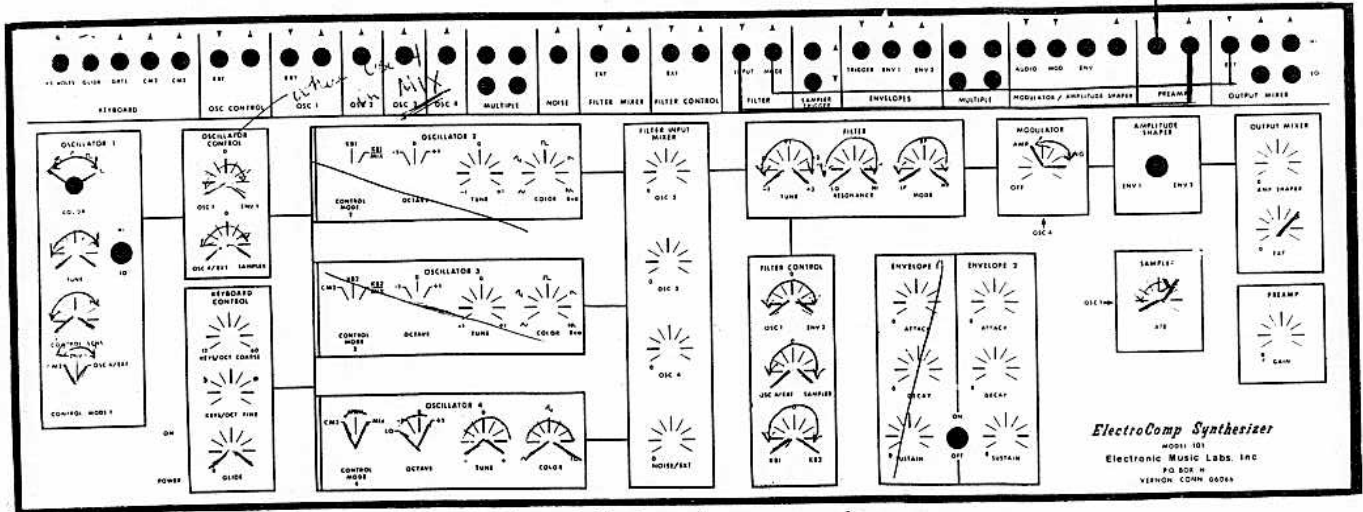

Filtering and Modulation of an external source.

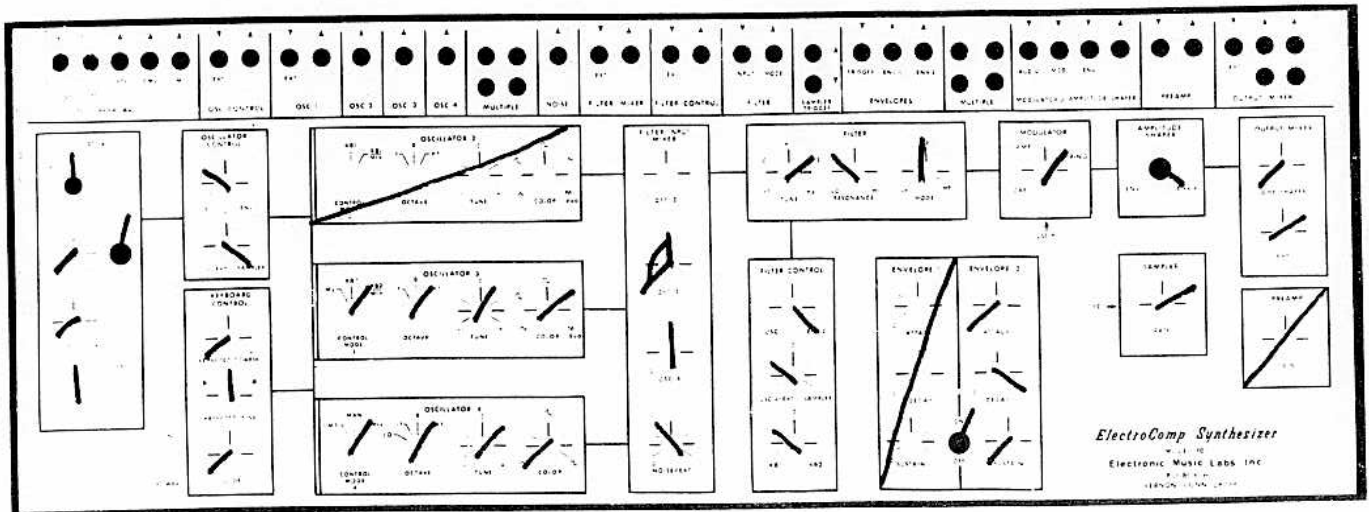

FANTASY SOUND #1

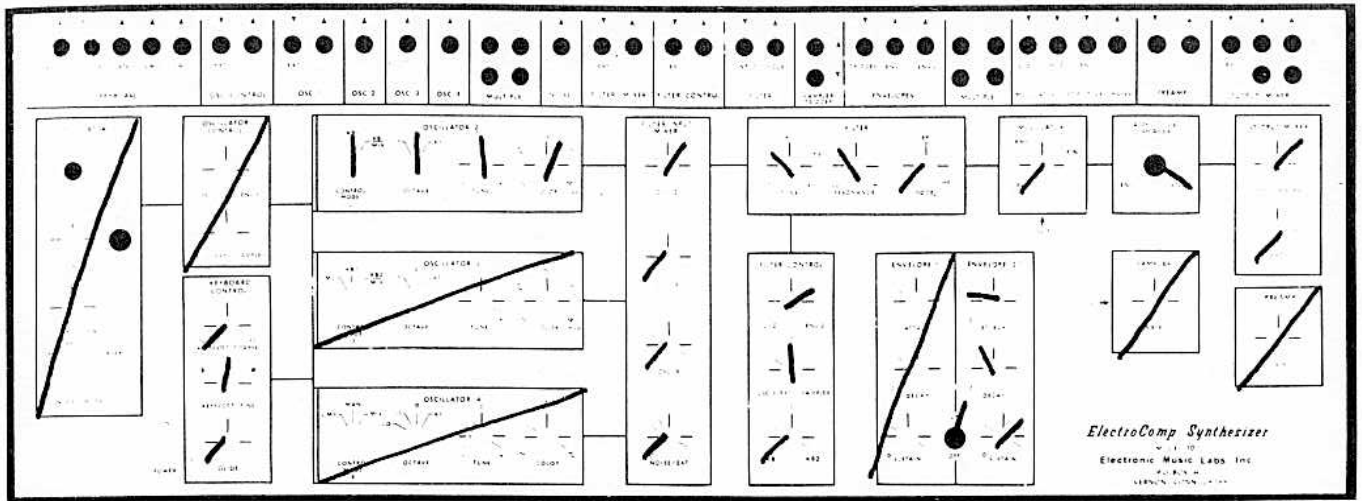

CLARINET

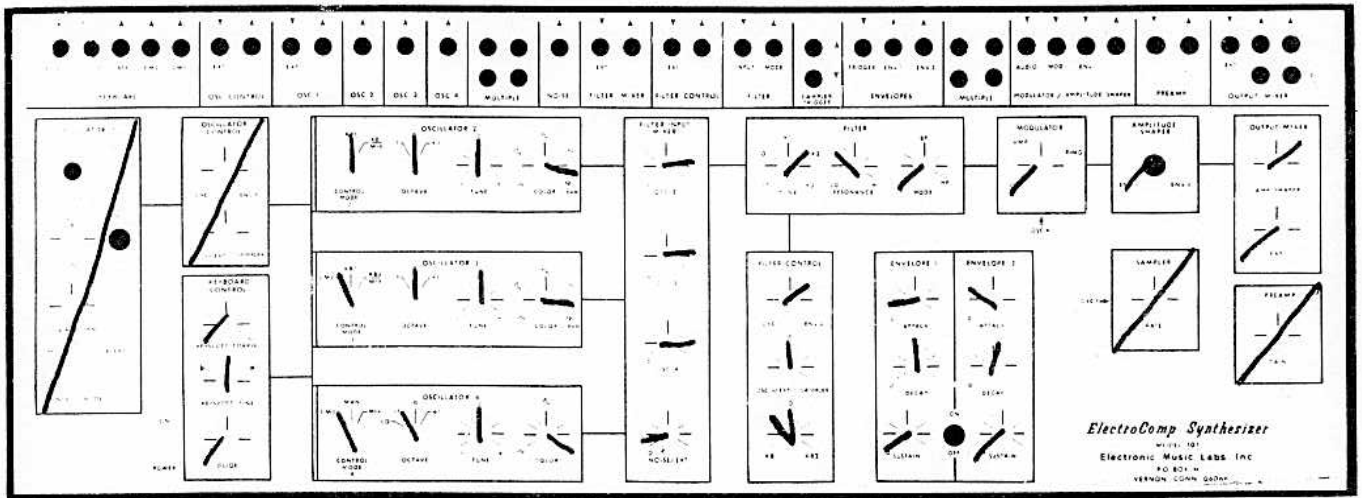

HORN

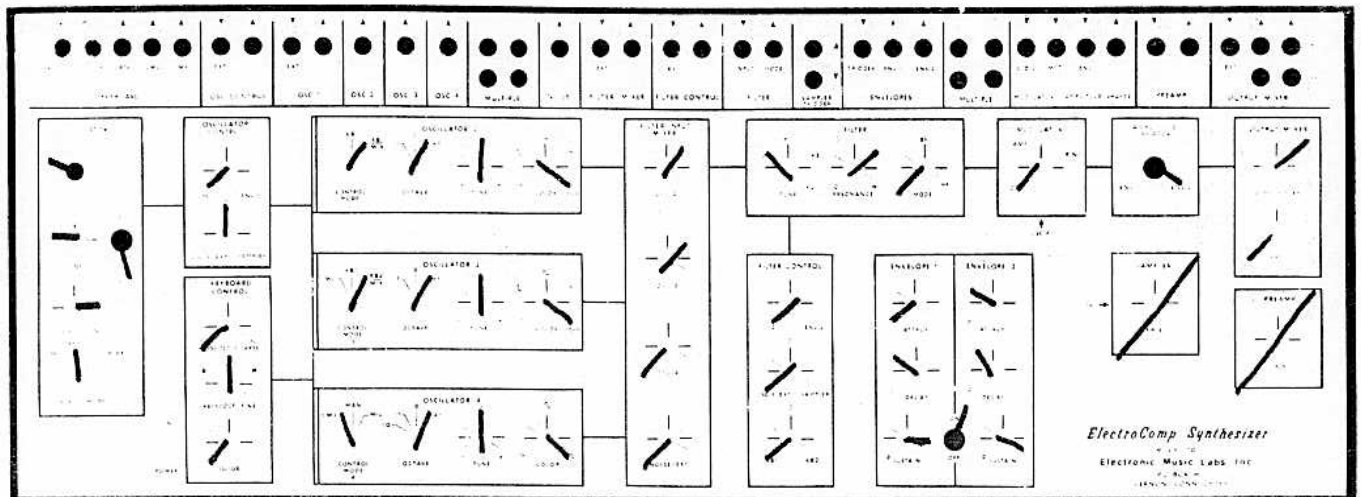

SIREN (Middle C)

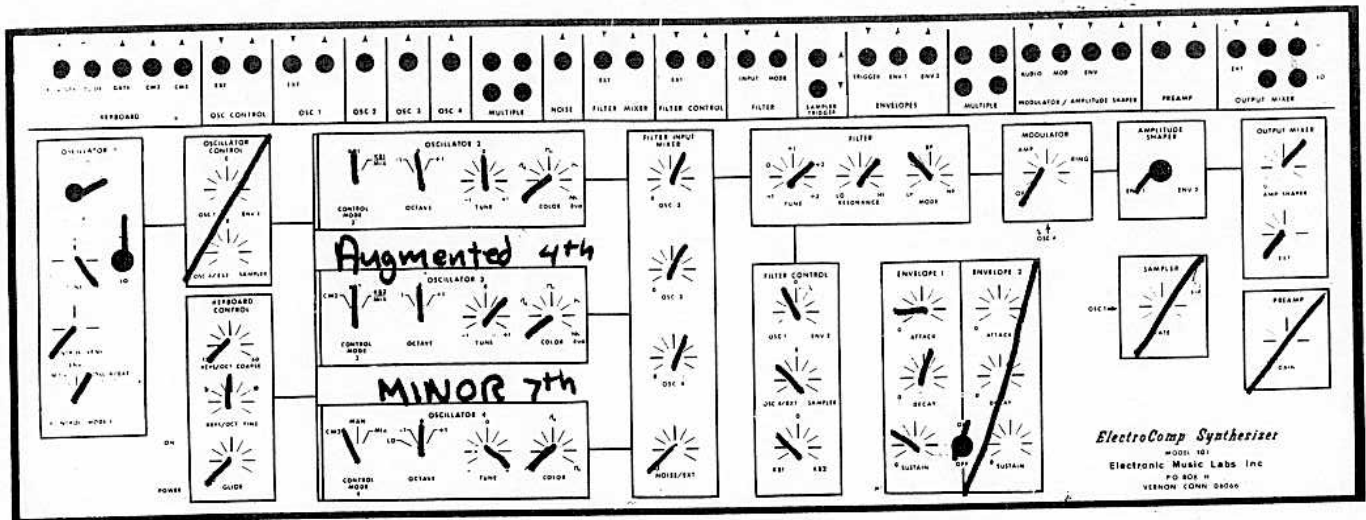

CHIMES

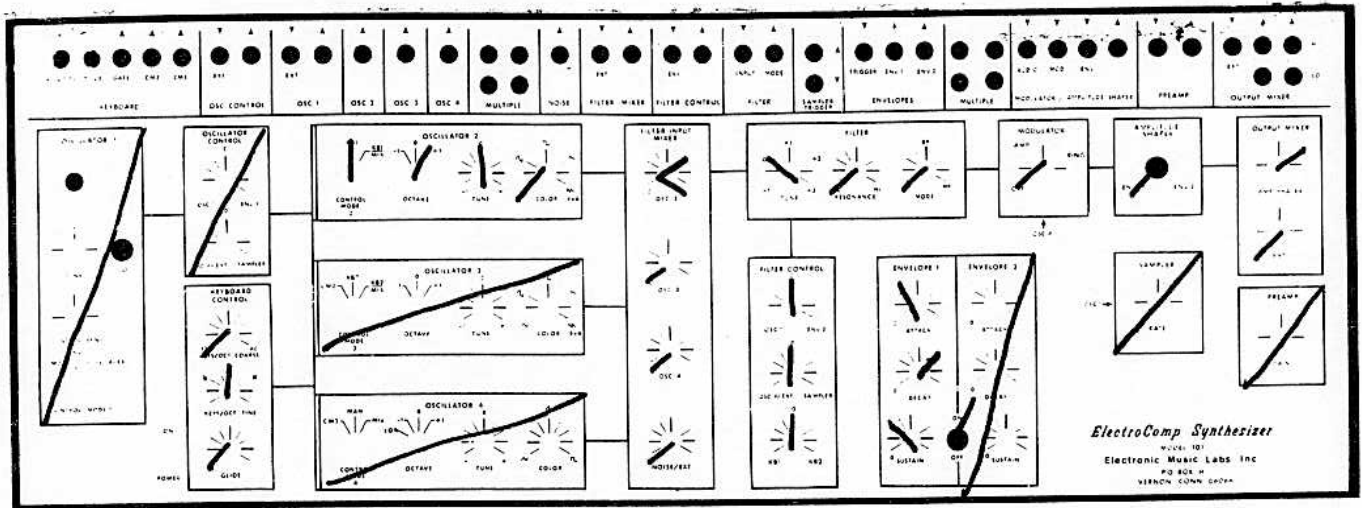

FLUTE

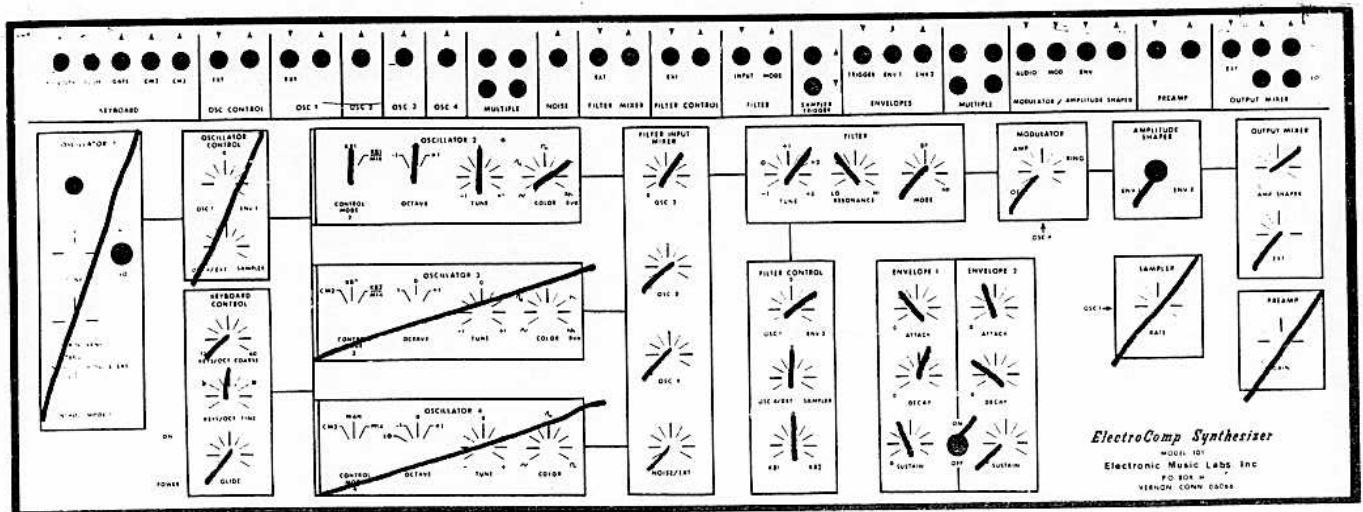

TROMBONE

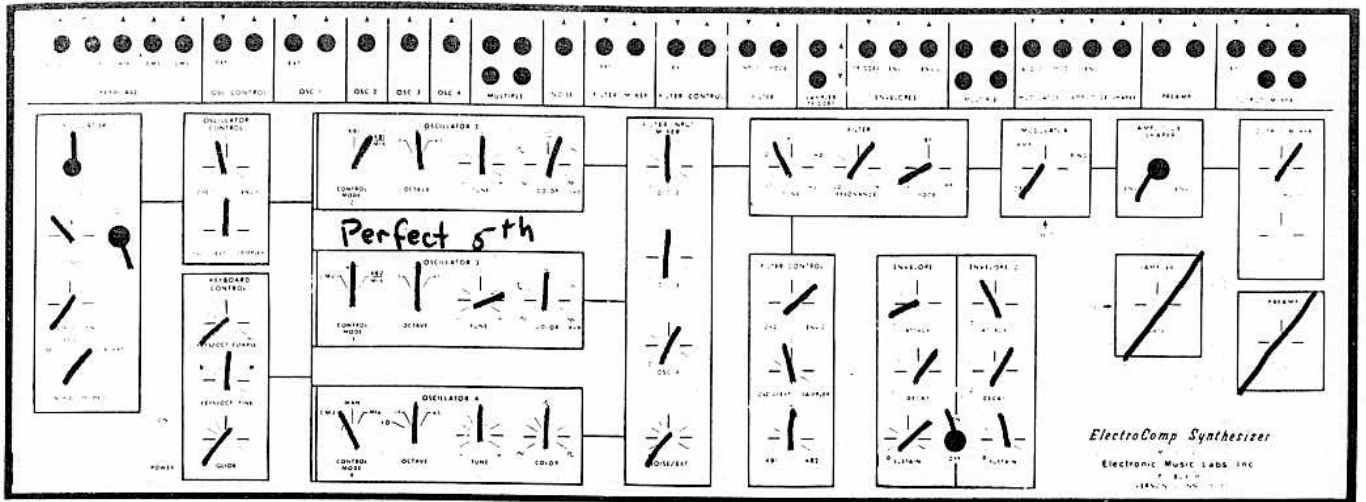

FRENCH HORN (Reverb Recommended)

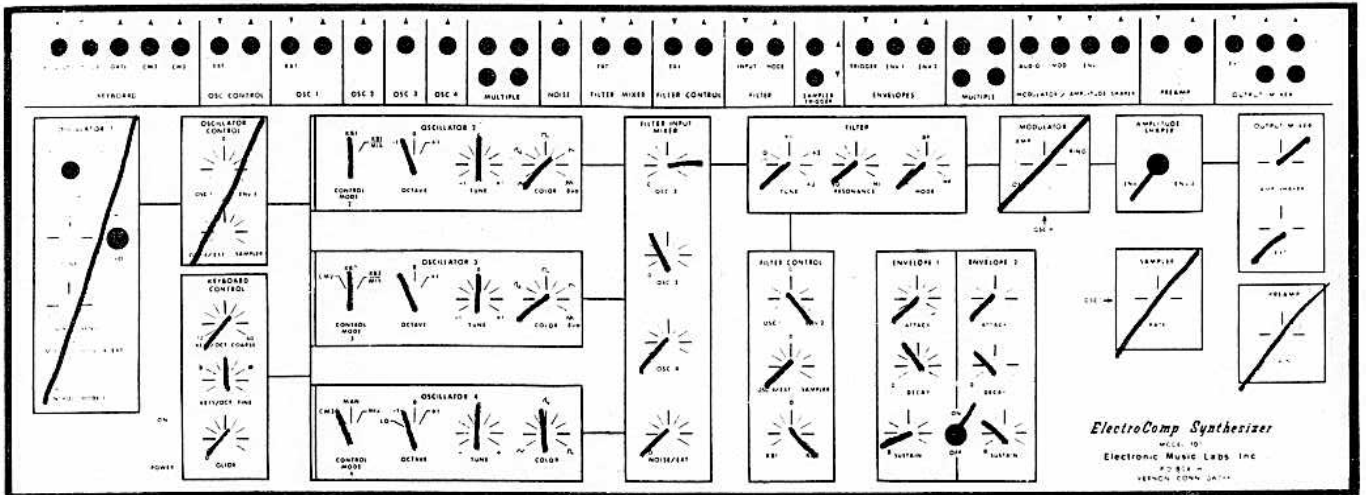

BASS GUITAR

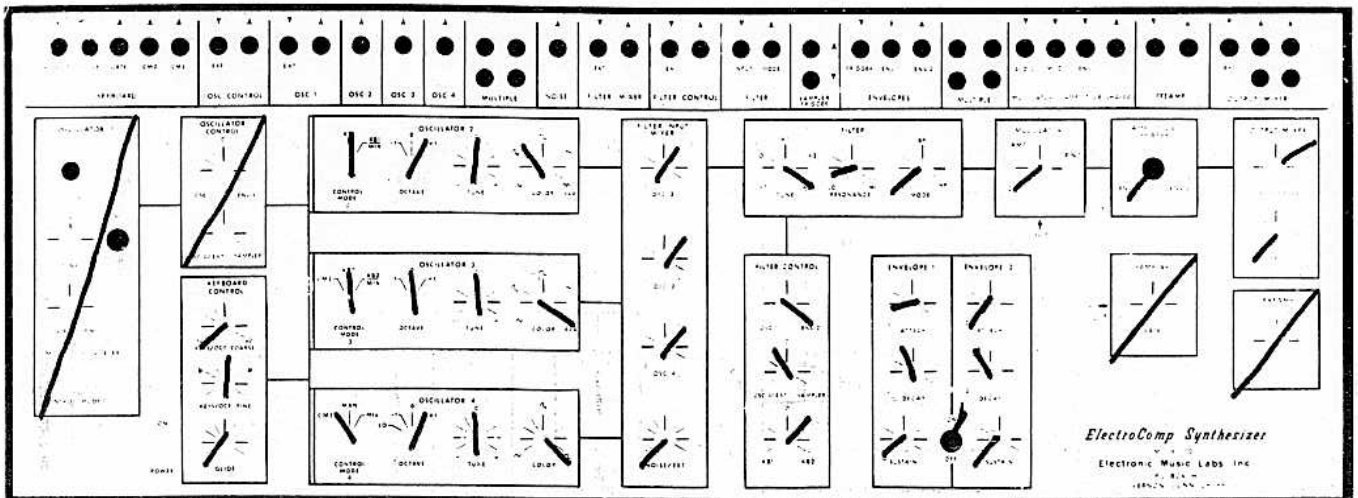

ELECTRIC PIANO

INVERTING ENVELOPE.

The OUTPUT MIXER may also be used to invert the ENVELOPE GENERATOR's output.

Normally the ENVELOPE when connected to the OSCILLATORS causes the pitch to increase. If inverted the ENVELOPE will cause the pitch to decrease.

The inverted ENVELOPE can be used to control both the FILTER and the OSCILLATOR. To do this, you can use the other output of the OUTPUT MIXER or take the present patchcord running to the OSC CONTROL MIXER and connect it to a MULTIPLE. From the MULTIPLE, you now have three outputs available.

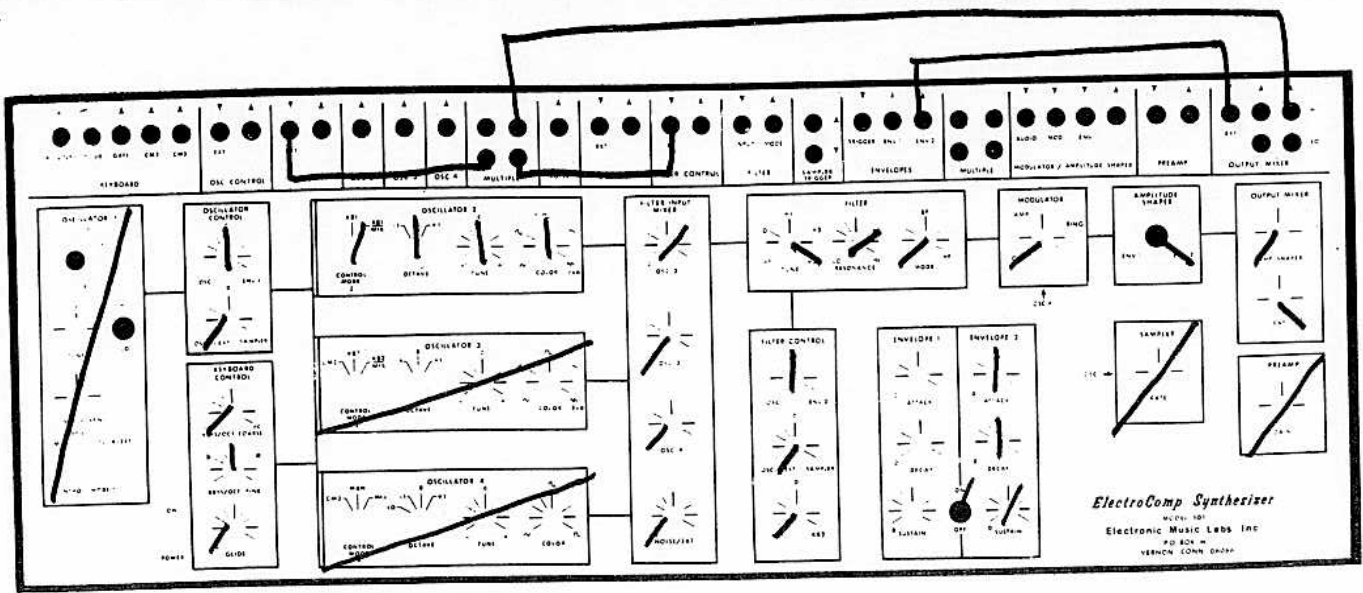
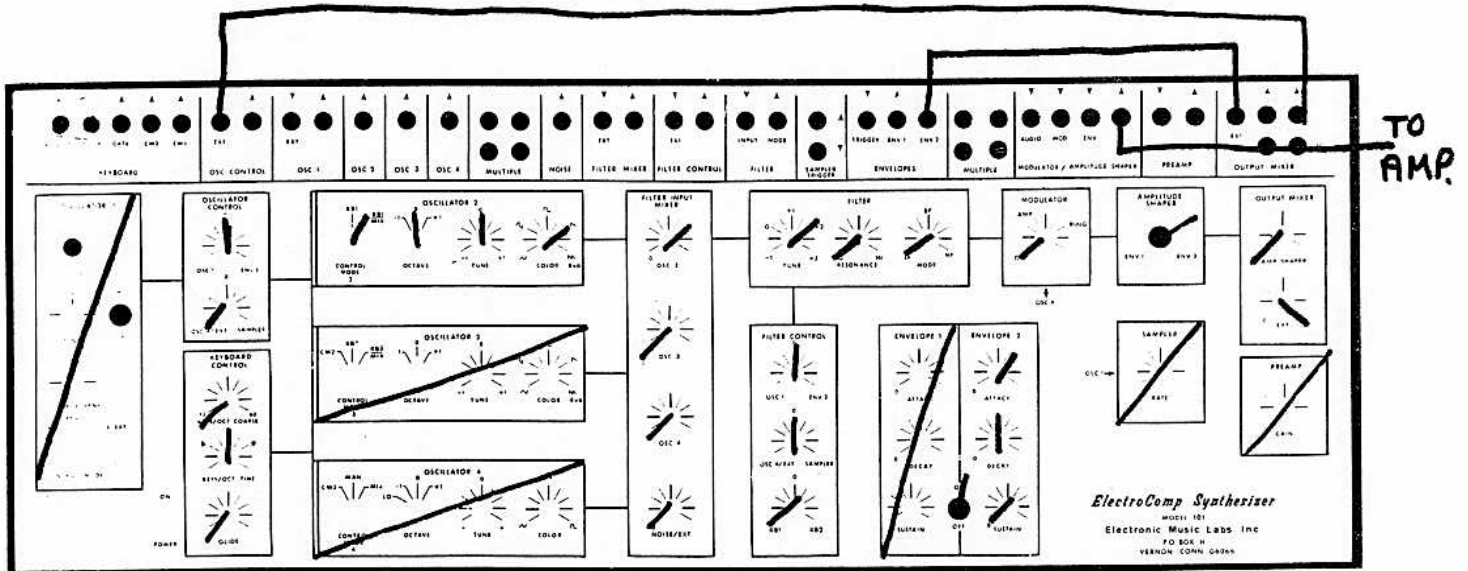

MODULATOR AS A SECOND AMPLITUDE SHAPER.

The MODULATOR has an external input labelled MOD. This input can accept an ENVELOPE output as an input.

In this patch, the KEYBOARD is triggering ENV 1. ENV 1 is set for long duration. The RATE control of the SAMPLER is triggering ENV 2. ENV 2 is set for a short duration.

As a result you'll hear a number of short ENVELOPES that gradually increase and decrease in loudness as ENV 1 increases and decreases.

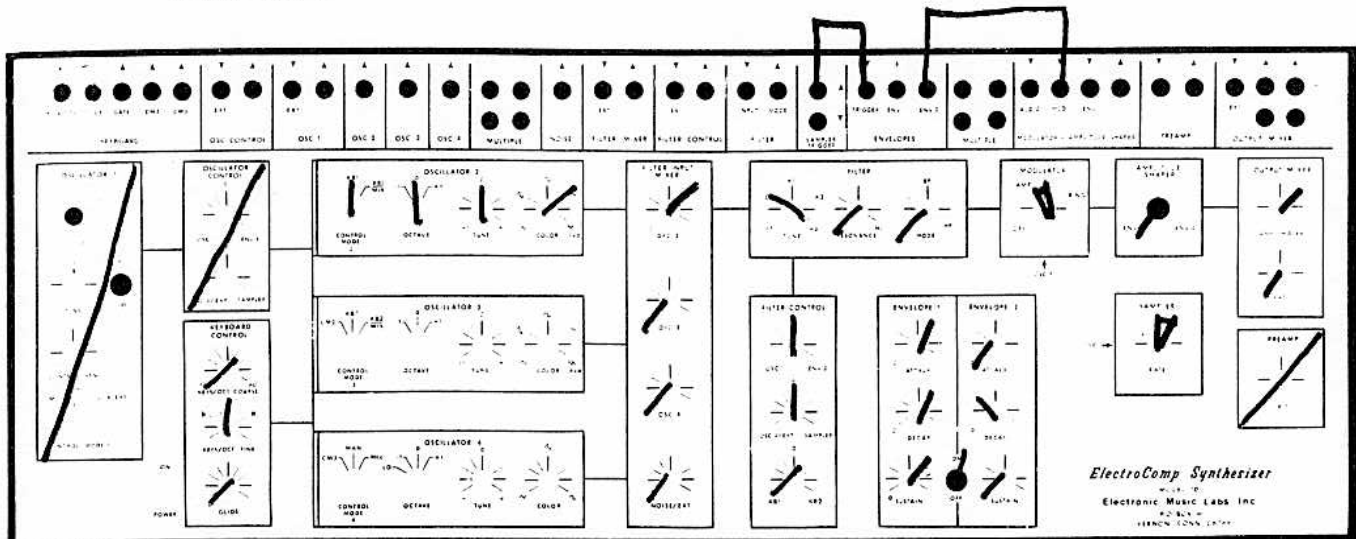

SAMPLER CONTROL OF ENVELOPES

The SAMPLER'S RATE control can also be used to trigger the ENVELOPE at the SAMPLING RATE.

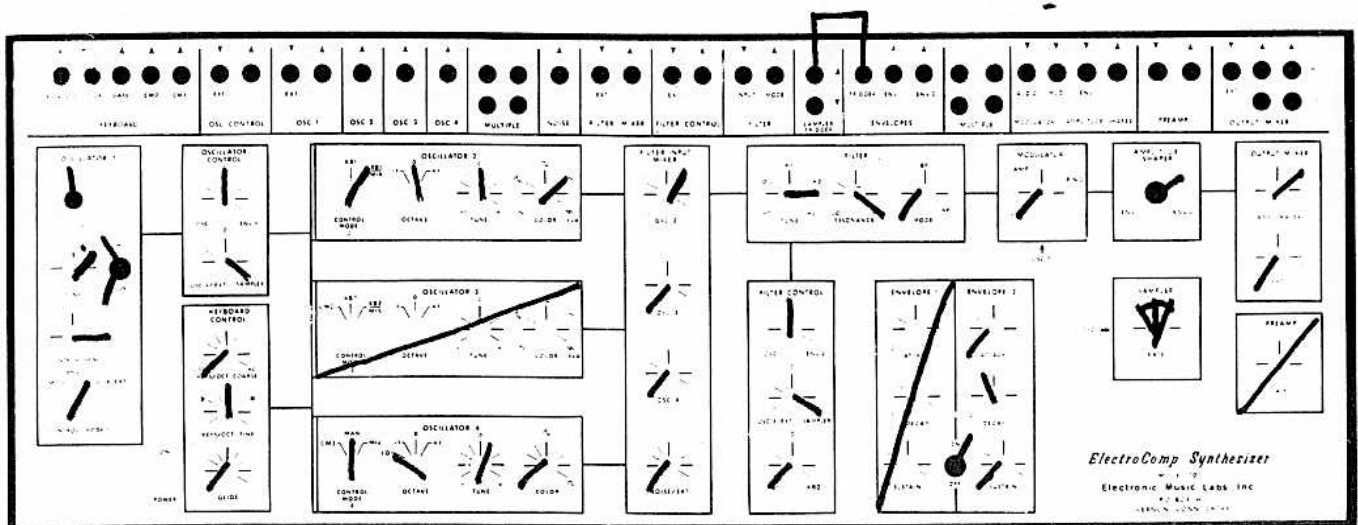

FOOT PEDAL CONTROL.

A foot pedal can be used to control just about any parameter of the synthesizer.

The patch shown permits the FILTER's tune frequency to be controlled from the foot pedal.

A similar patch could control the OSCILLATOR's pitch.

If the foot pedal were connected between OSC 1's output and the OSC CONTROL MIXER's external input, the amount of vibrato could be controlled from the foot pedal.

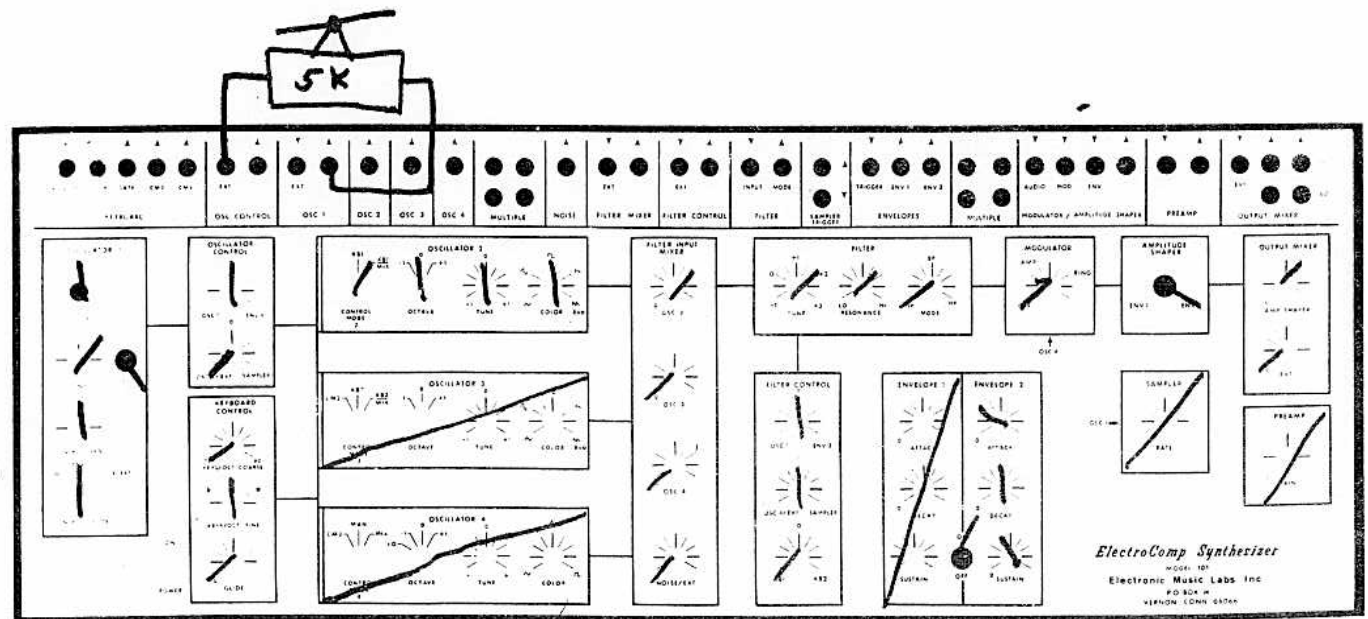
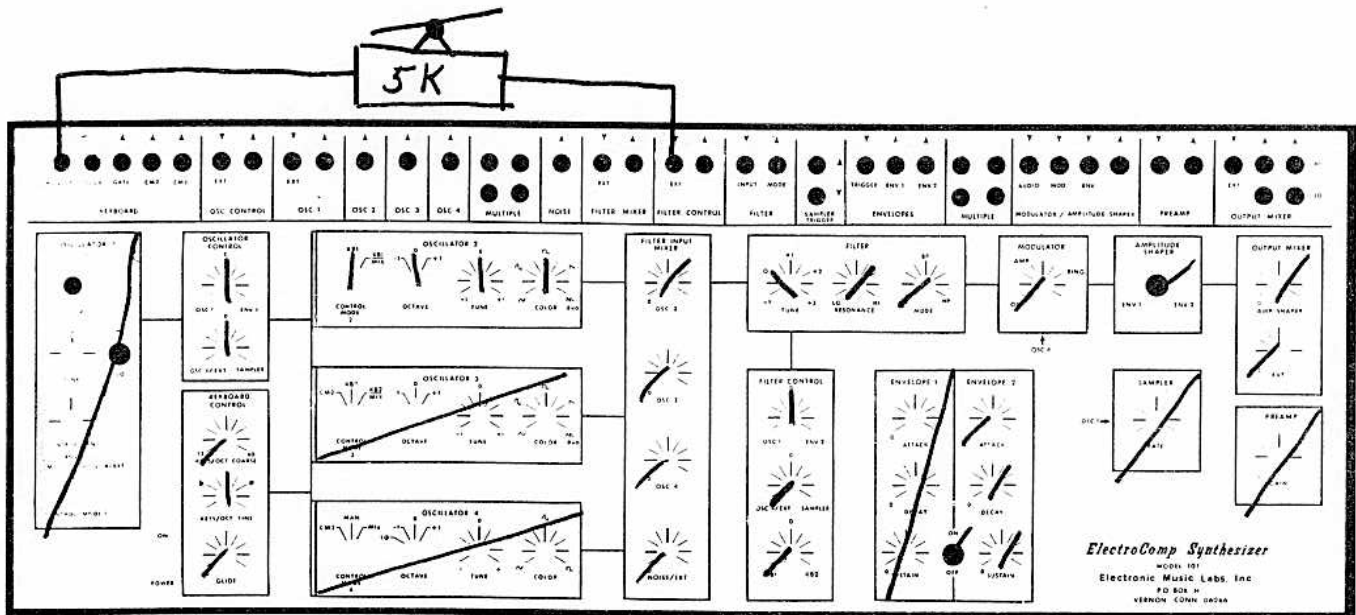

OSC 4 REPLACES SAMPLER'S RATE OSC.

The SAMPLER's built in RATE OSCILLATOR can be replaced by OSC 1 or OSC 4 to permit voltage control of the sampling rate.

In this patch, the sampling rate will double for each octave increase.

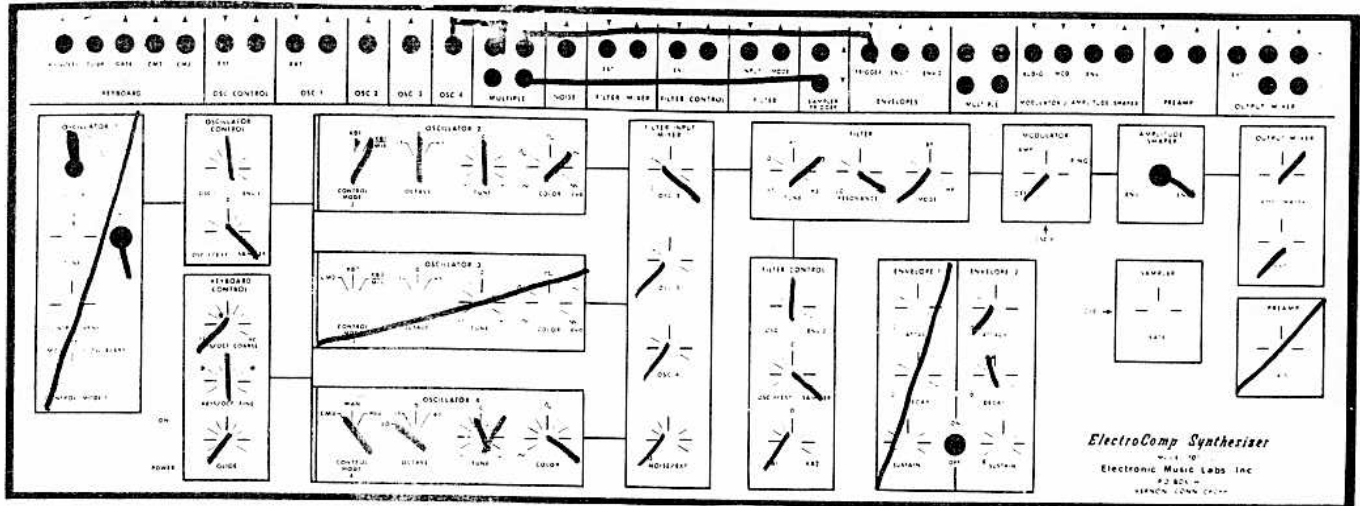

PREAMP

The PREAMP is used for introducing low level audio signals to the synthesizer.

The output of the PREAMP may be patched into any input for subsequent modification.

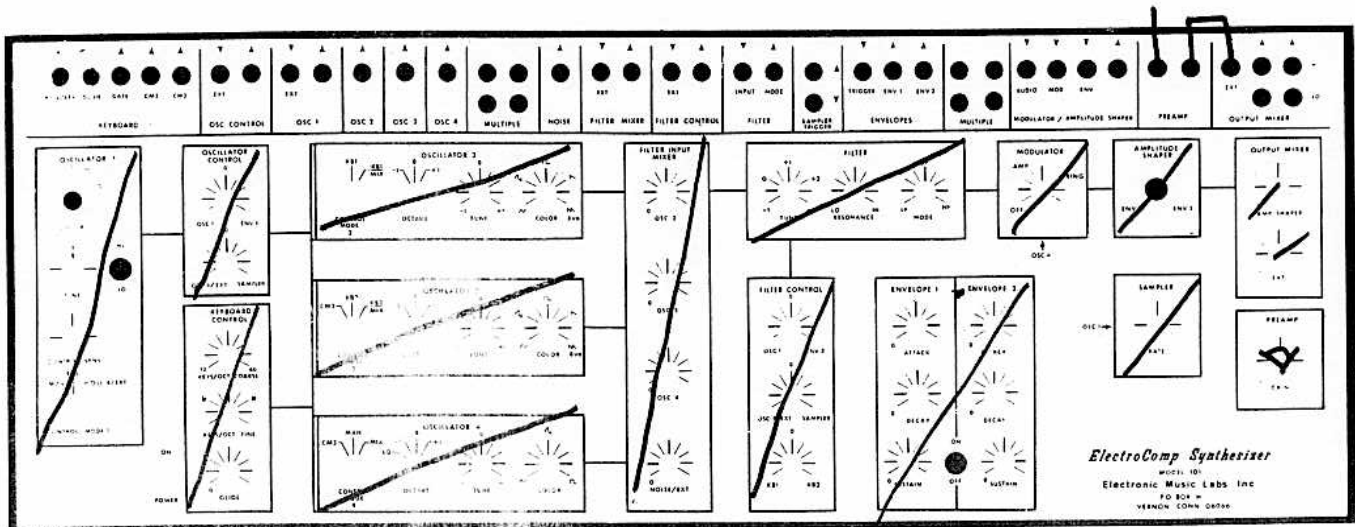

FOOT PEDAL SWITCHING OF GLIDE.

The 101's patch panel provides an input for the selective use of GLIDE from a foot switch. The foot switch is available for \$22.50 from the factory.

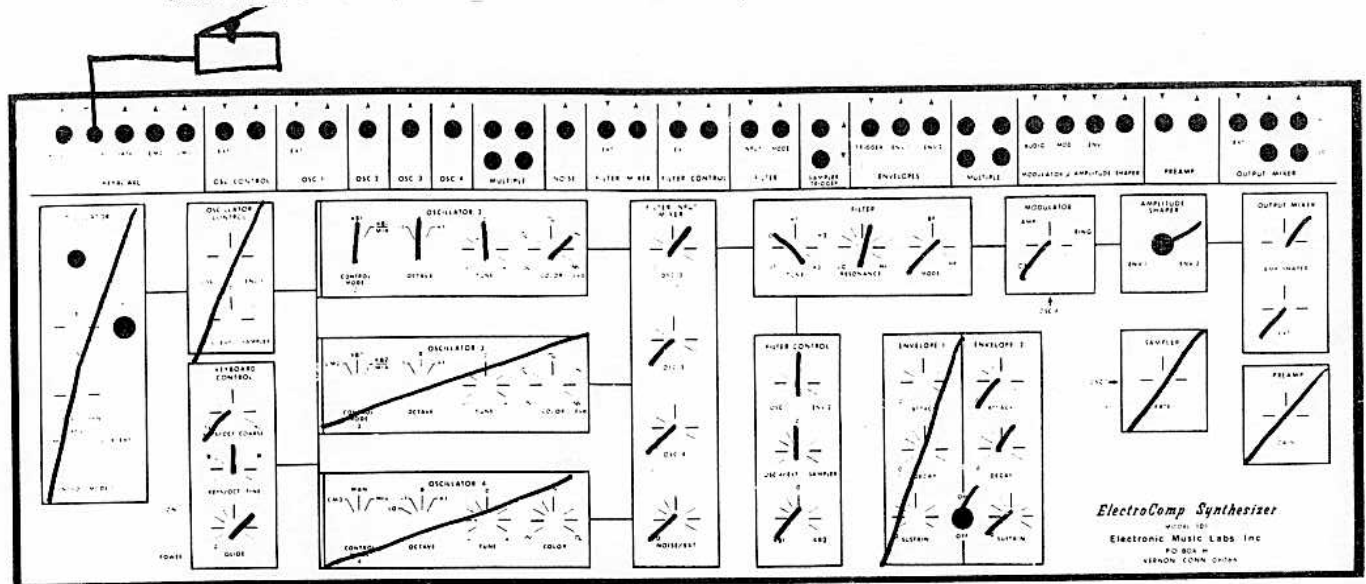

SPECIAL GLIDES.

When OSC 2 is in the KB1 MODE, and OSC 3 in the KB2 MODE, the GLIDE control only effects OSC 2.

This patch demonstrates this effect.

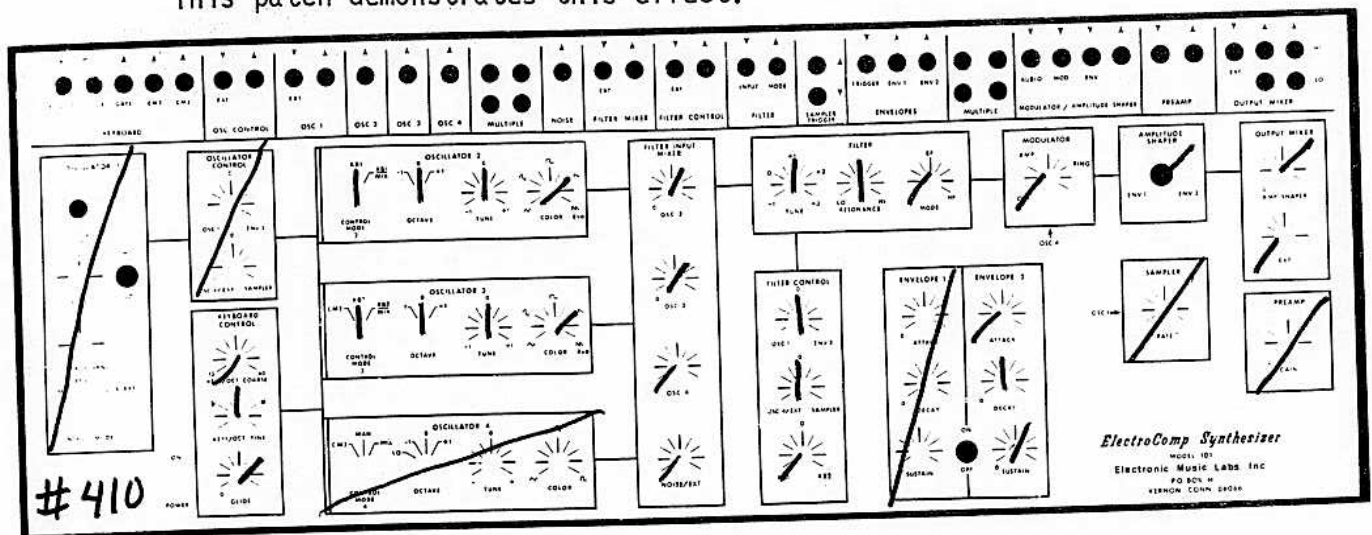

Depress and release low F.

Depress F up an octave.

DELAYED ENVELOPE.

This patch demonstrates the ability of ENVELOPE 1 to trigger ENV 2.

In this patch ENV 2 will not occur until ENV 1 has reached a preset amplitude level.

This fact permits you to use the ATTACK control of ENV 1 to determine when ENV 2 will occur.

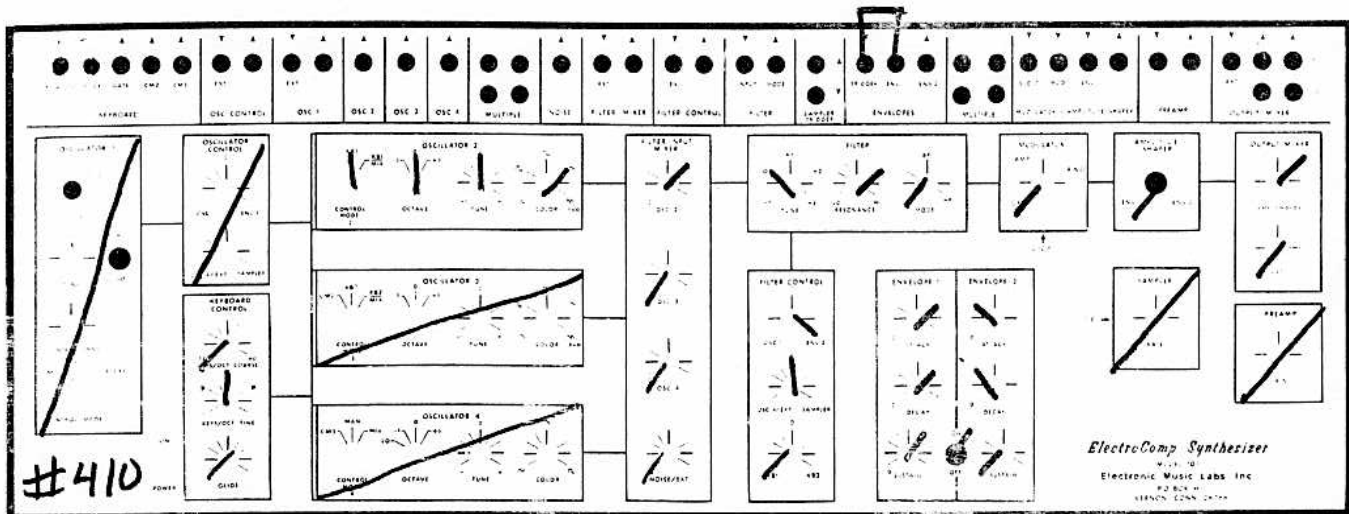

RANDOM TIMBRE.

In this patch, the KEYBOARD GATE is used to trigger the SAMPLER each time a key is depressed.

The SAMPLER output is then connected to the filter and results in random selection of timbre with each key depression.

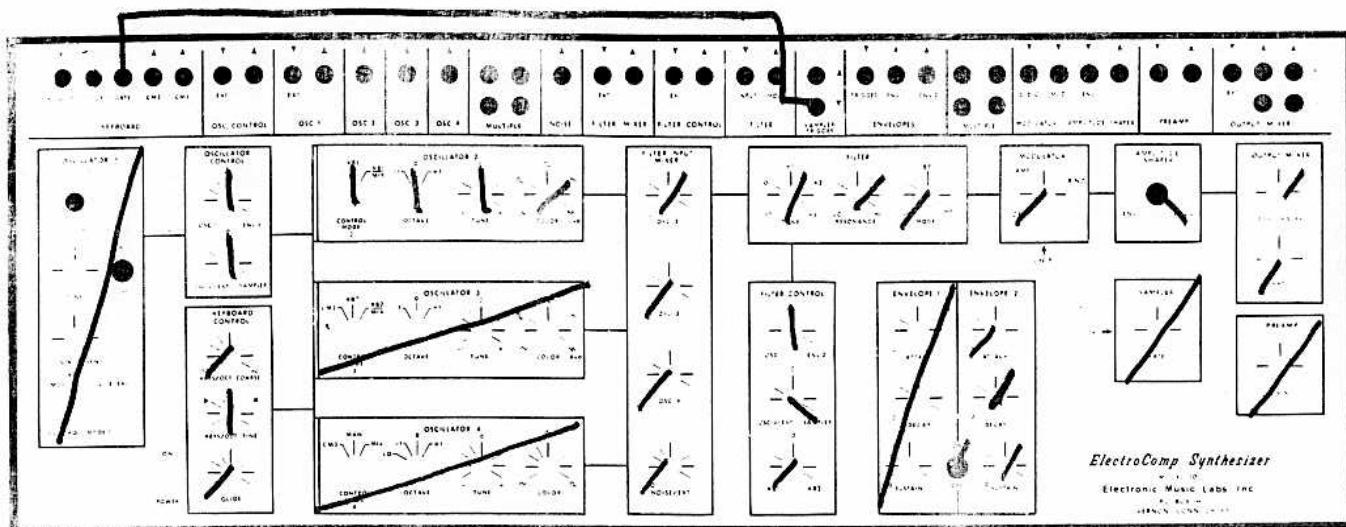

THE 101/200.

Your 101 can be readily expanded with the addition of the EML 200 Studio synthesizer. The combination of the two instruments will add greatly to your musical ability. It is a case of the whole being greater than the sum of the parts.

When you own both, your capability exceeds all but the large modular systems.

After opening the 200, spend some time reading its manual. The 200 manual is not very technical, but it should provide you with a good feel for each function of the 200.

While reading the 200 manual, some of the simpler uses of the 101/200 combination will be immediately obvious.

In most cases, the obvious settings will not be covered in this section, but will be left for you to discover.

Using the MASTER OSCILLATOR of the 200 as a vibrato oscillator for the 101 is an obvious setting. This permits the use of OSC 1, 2, 3 and 4 as Audio Oscillators.

In the same category however, you might not discover the following vibrato capability.

This patch gives you vibrato where the amount of vibrato (amplitude) varies as the note decays.

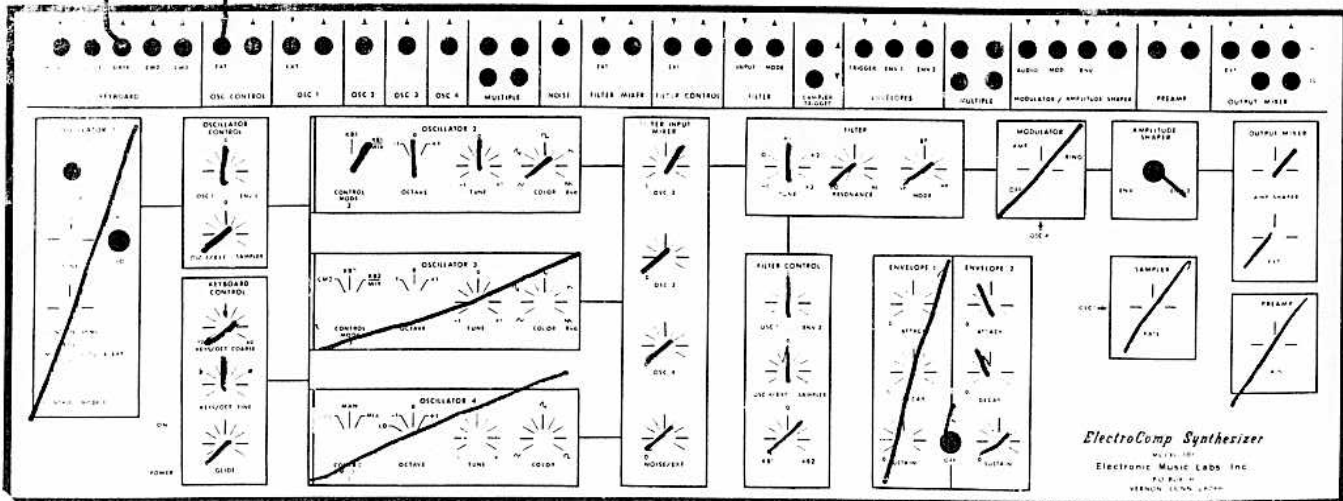
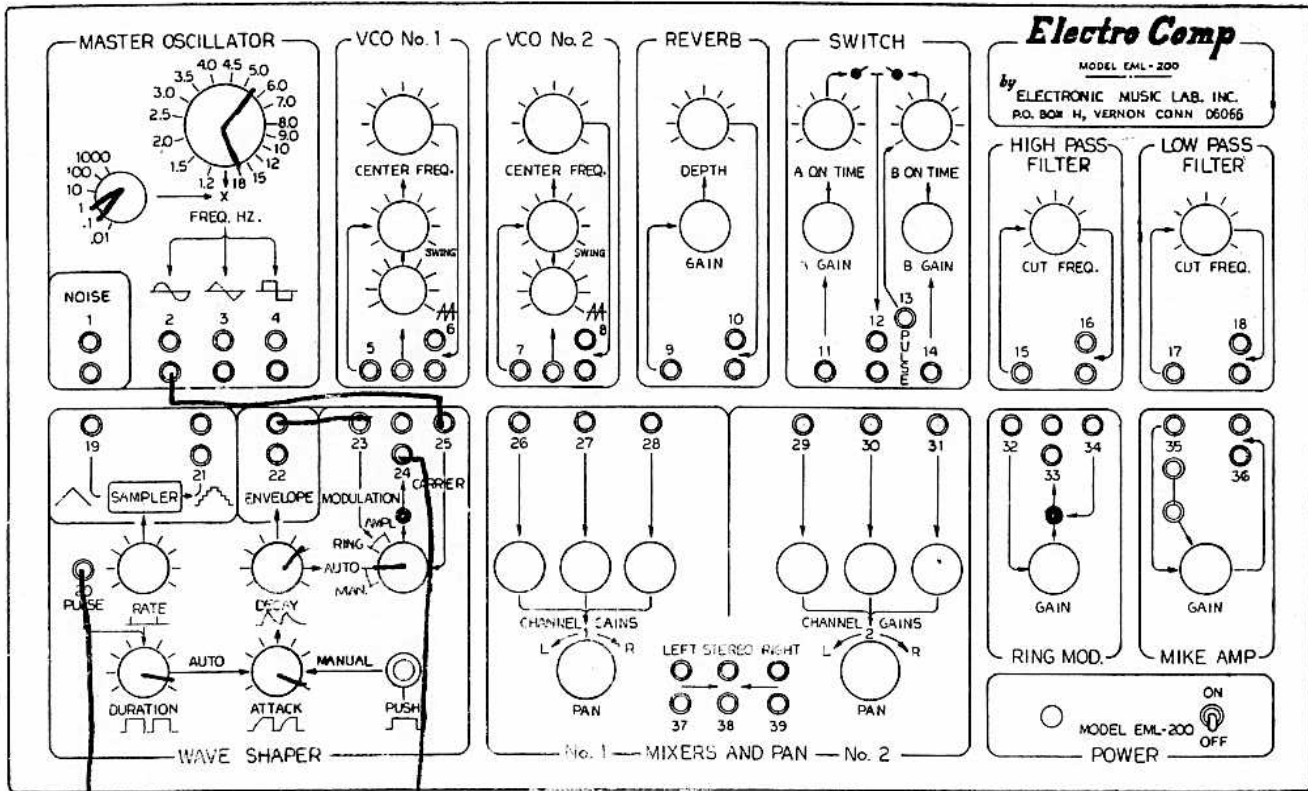

This patch gives you two alternating vibratos.

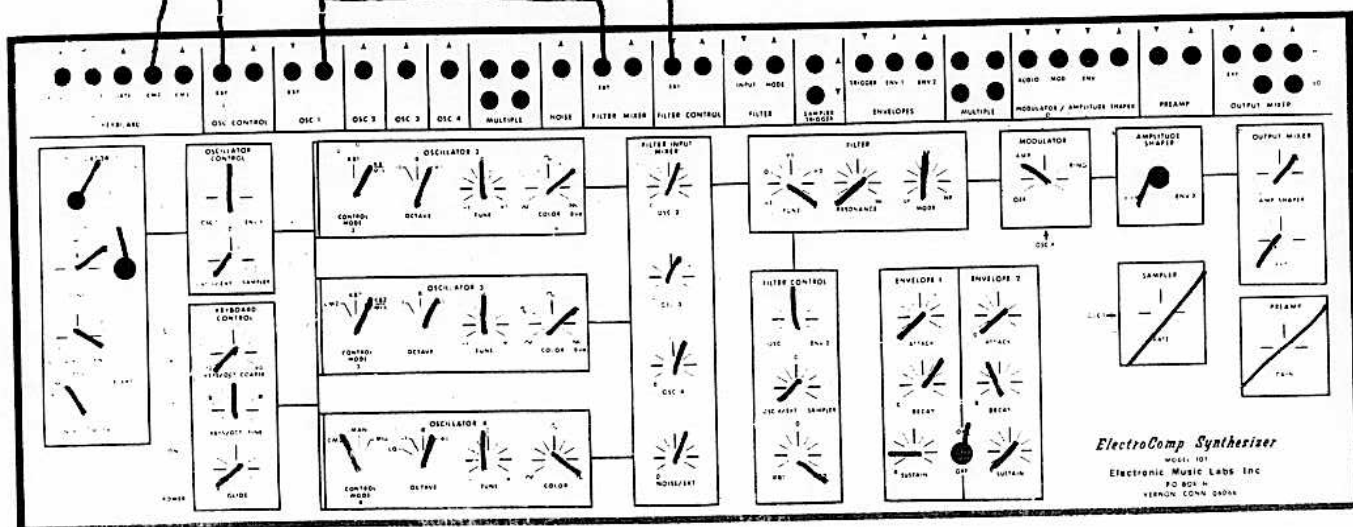
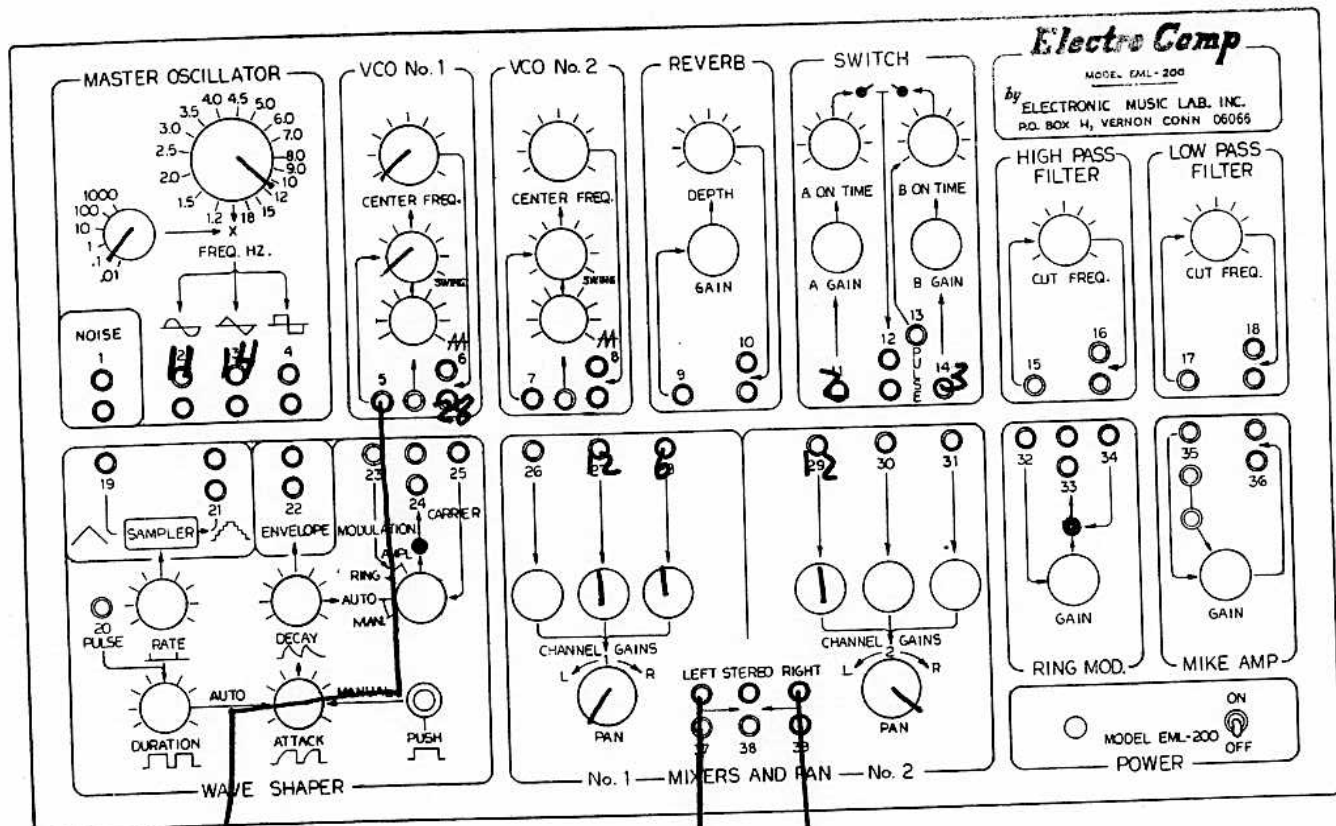

Of course, these two patches could be used to control the FILTER.

It should be evident that the 200 can modify the output of the 101 by:

1. Reverberation.
2. Manual panning from one channel to the other.
3. Overall high pass/low pass filtering.

KEYBOARD CONTROL OF VCO1 AND VCO2.

Before making any connections between the 101 and 200, adjust the 200's VCO FREQUENCY controls so that the VCO's barely tick at 1 click per second or less.

Now connect the 101 and 200 as diagrammed. You should find the VCO to be properly octavated. The VCO's SWING control can be used for octavation.

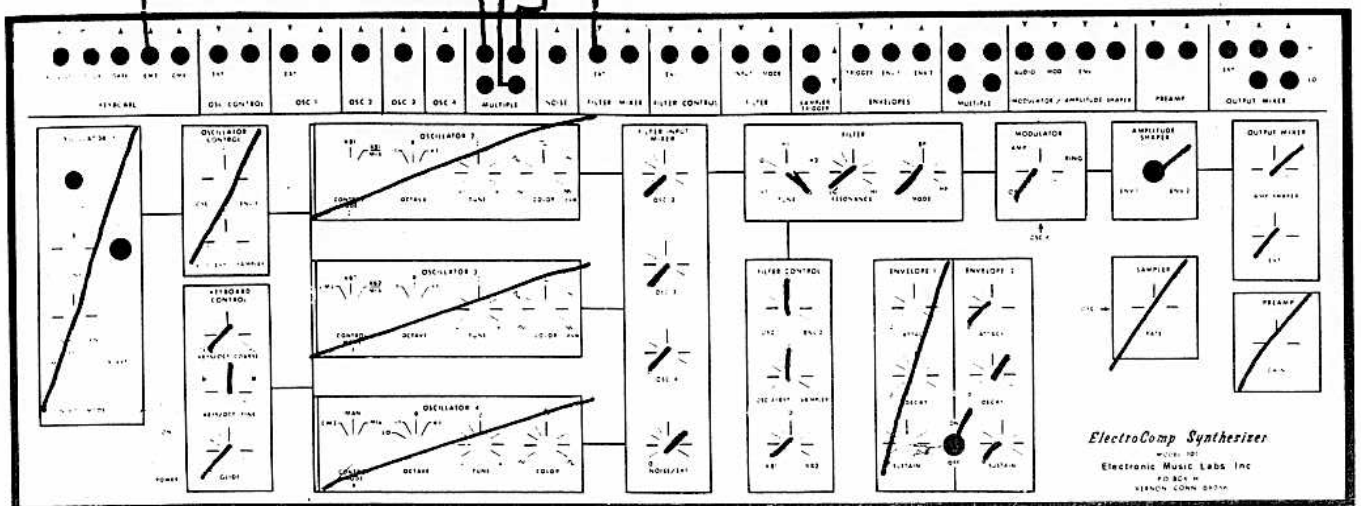
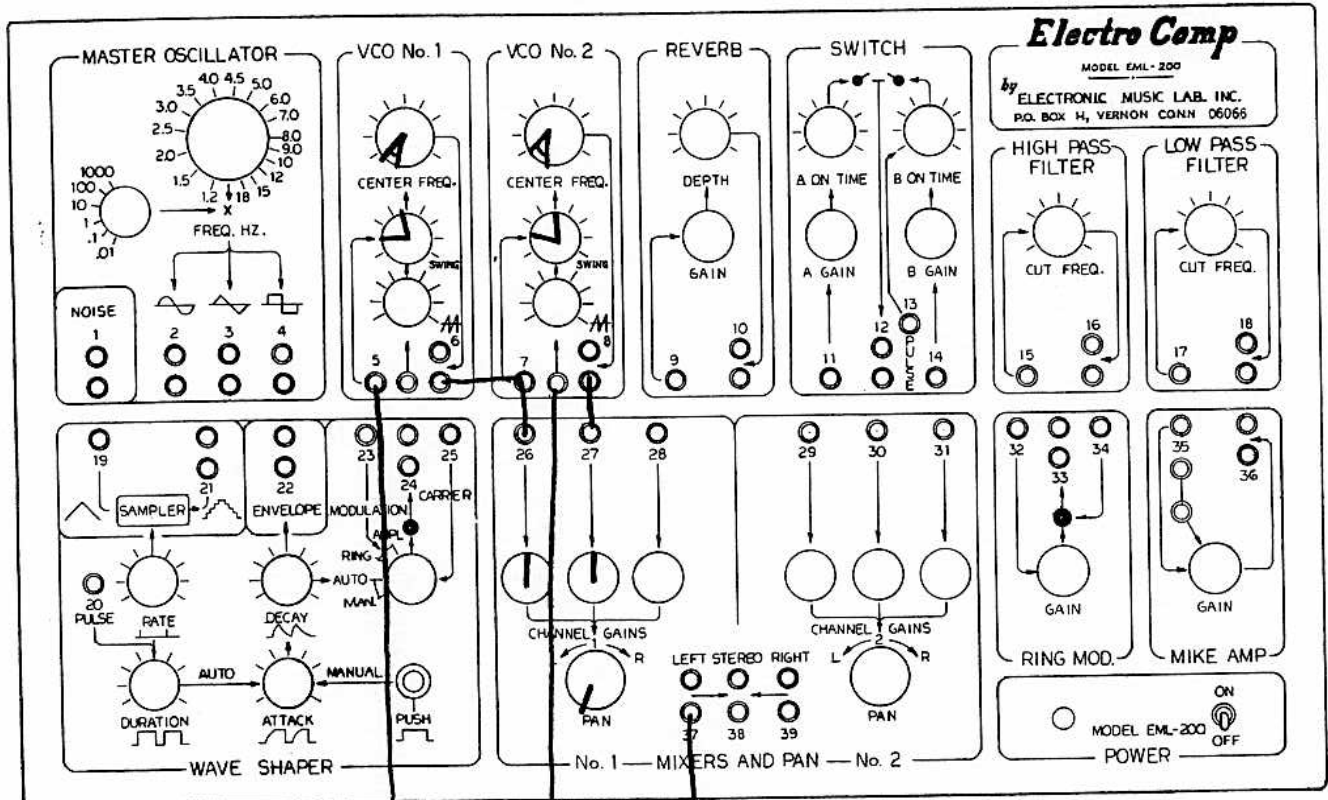

BURST OF WHITE NOISE.
 This patch provides a burst of while noise at the beginning
 of each key depression.

The GATE output of the 101 is being used to initiate the 200's
 ENVELOPE GENERATOR.

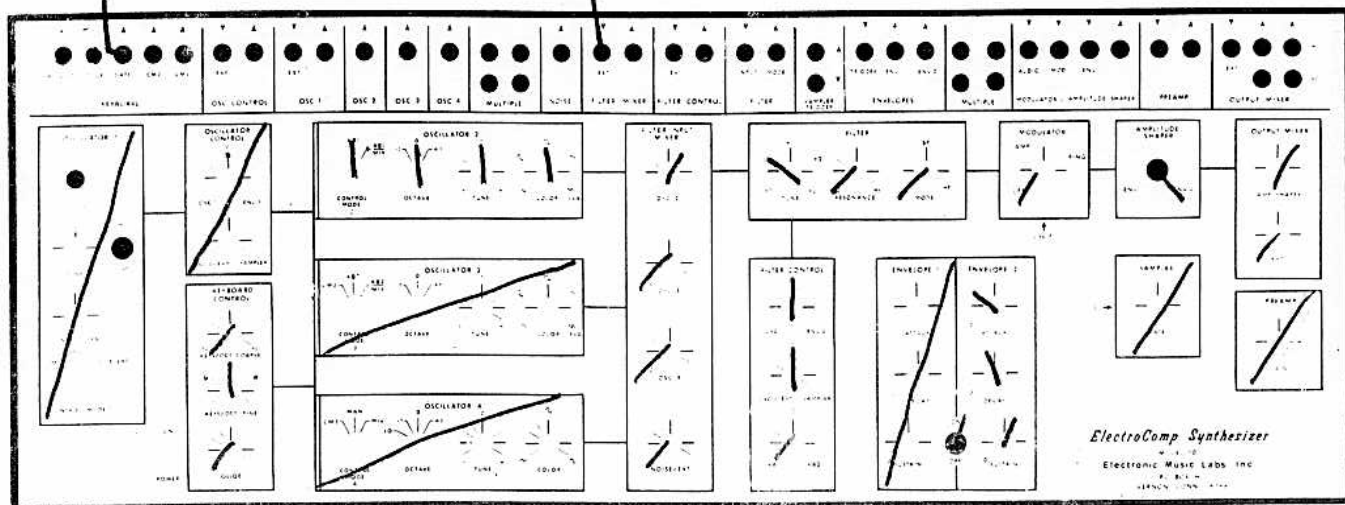
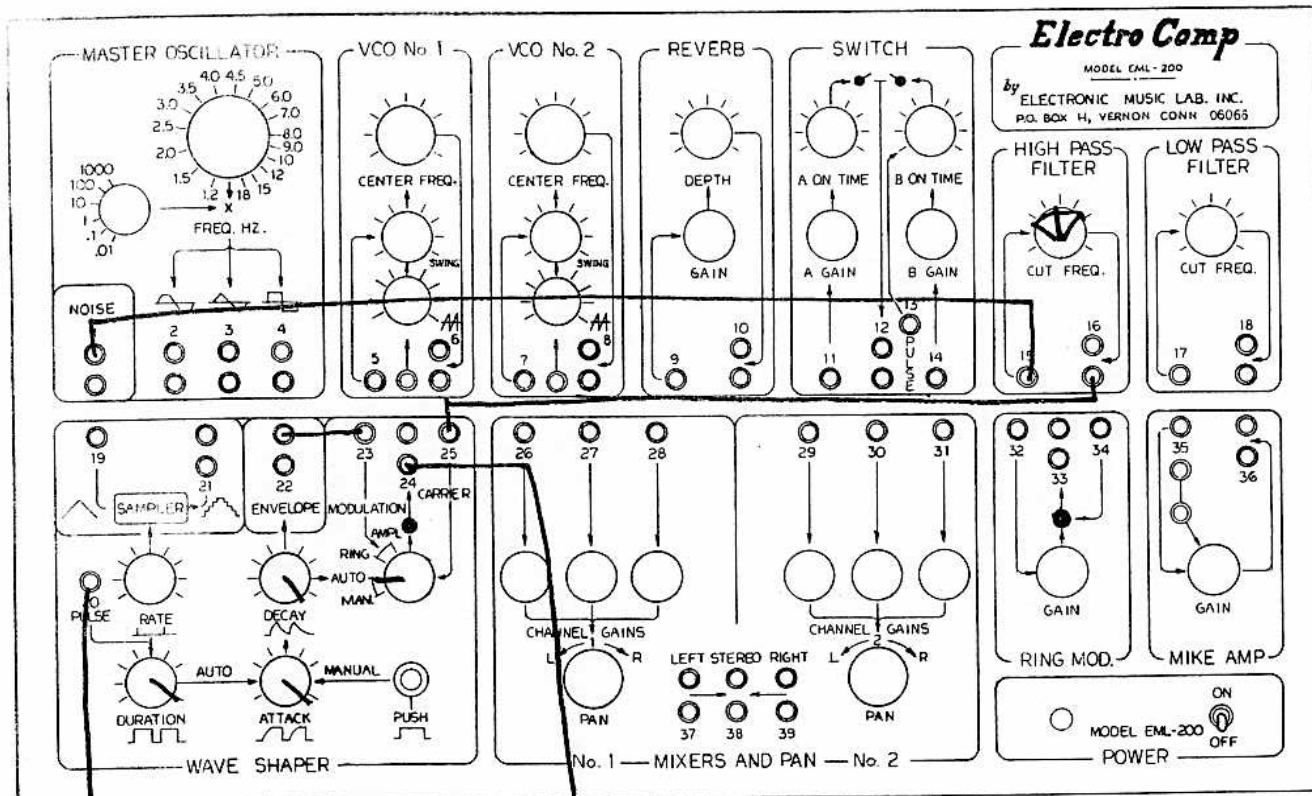

MANUAL PANNING.

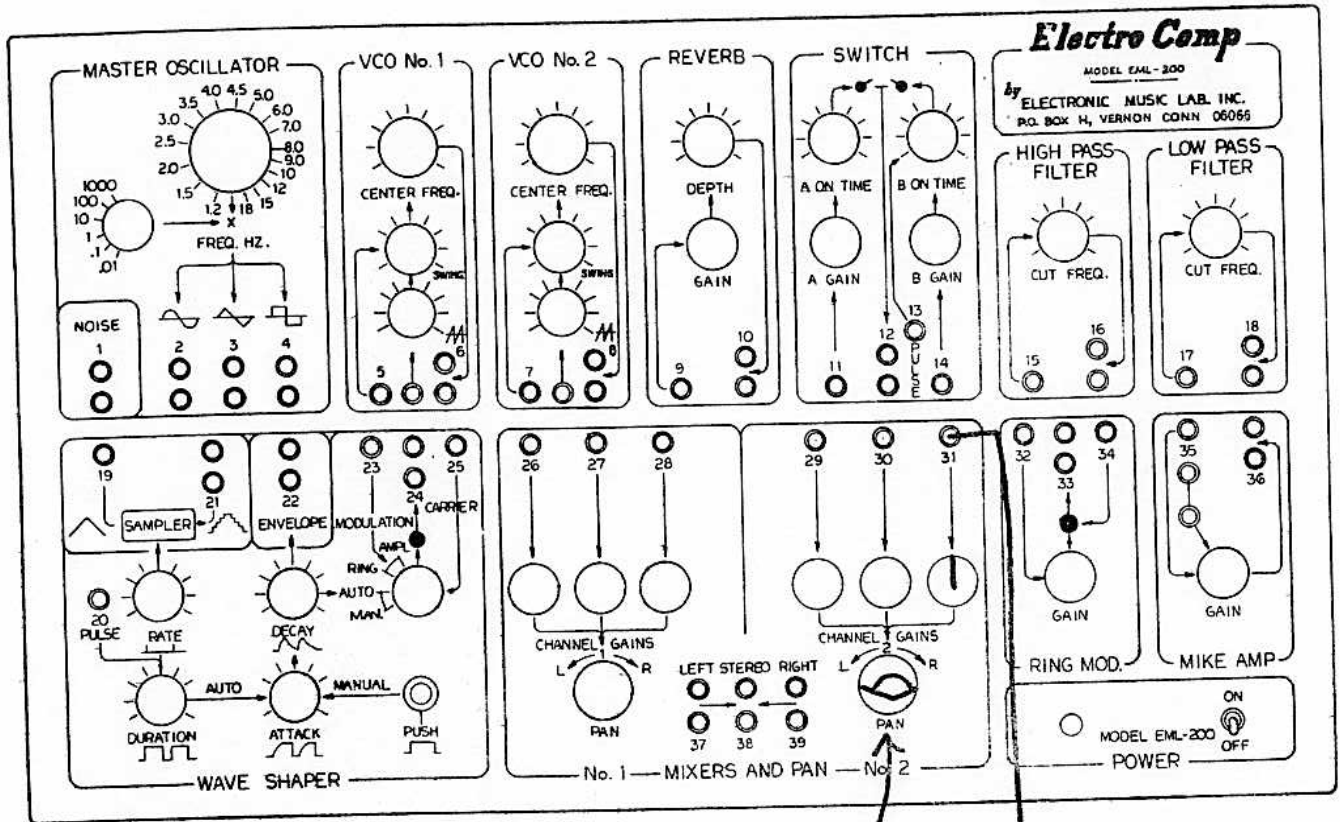

ROTATE

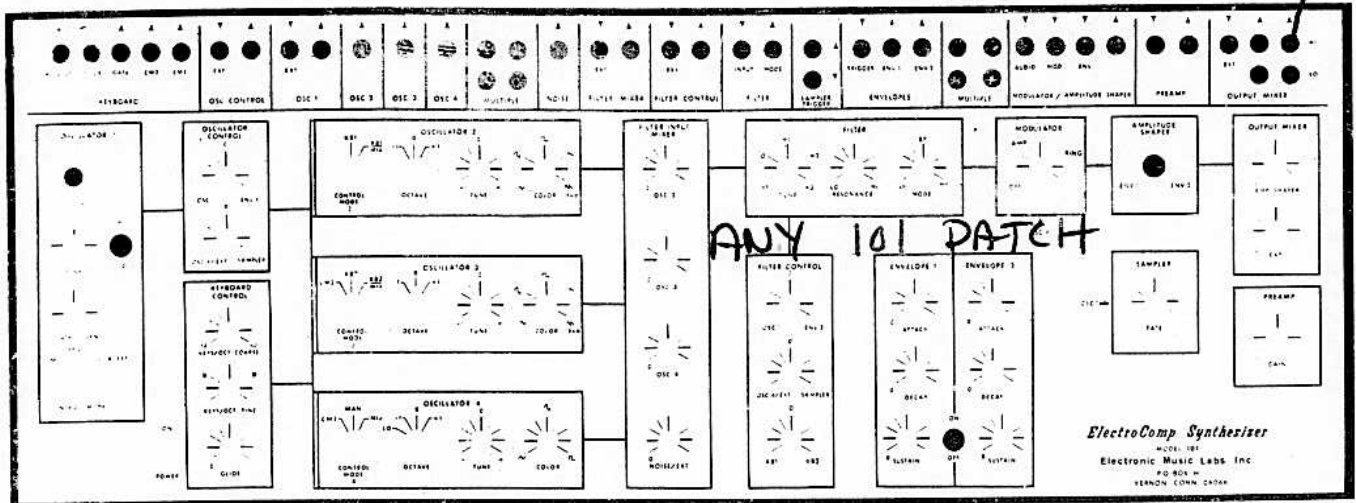

AUTOMATIC PANNING.

PANNING SPEED

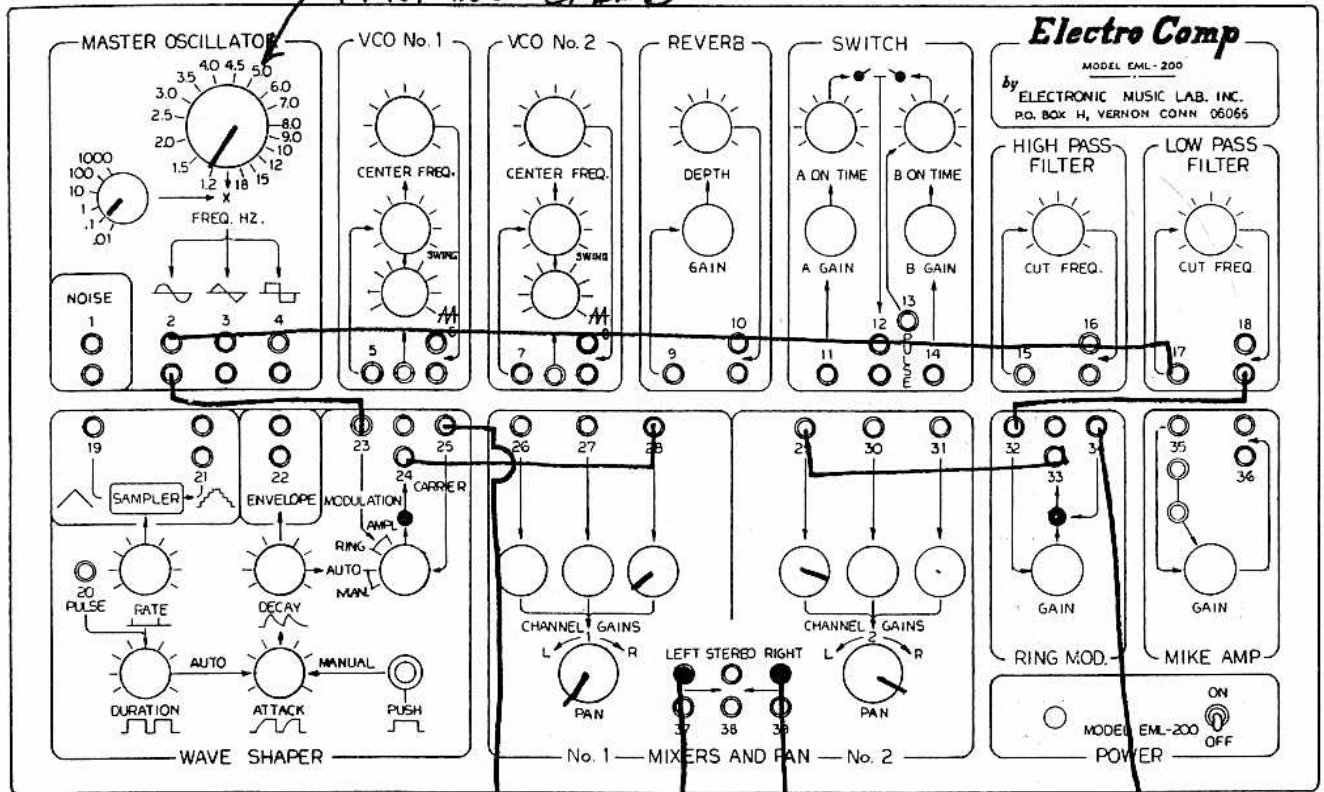

TO LEFT AND
RIGHT AMP CHANNELS

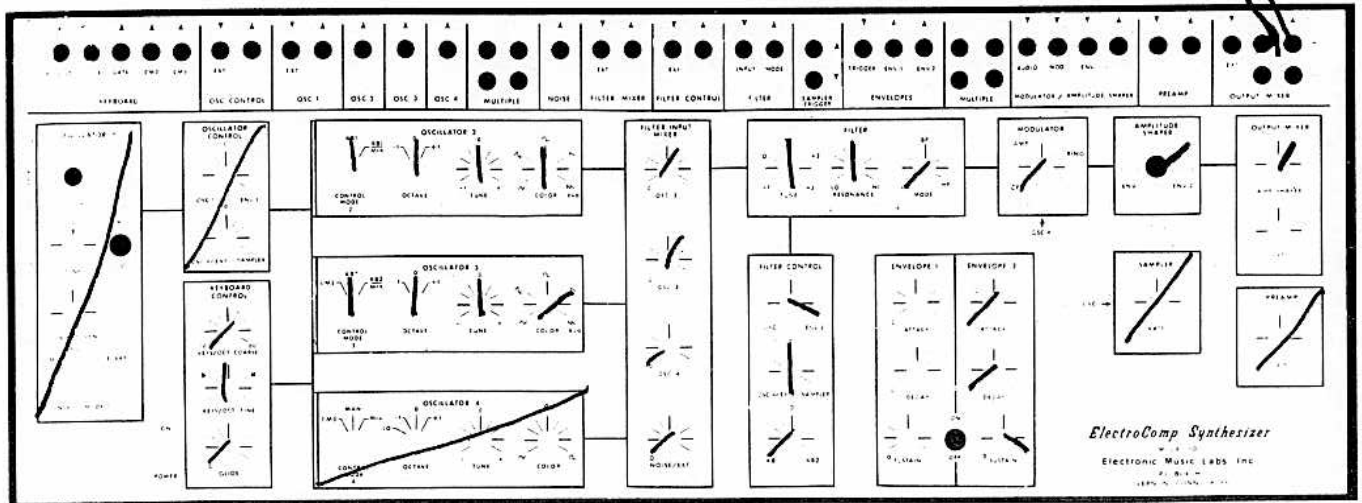

MULTIPLE ENVELOPE MODULATION OF TIMBRE.

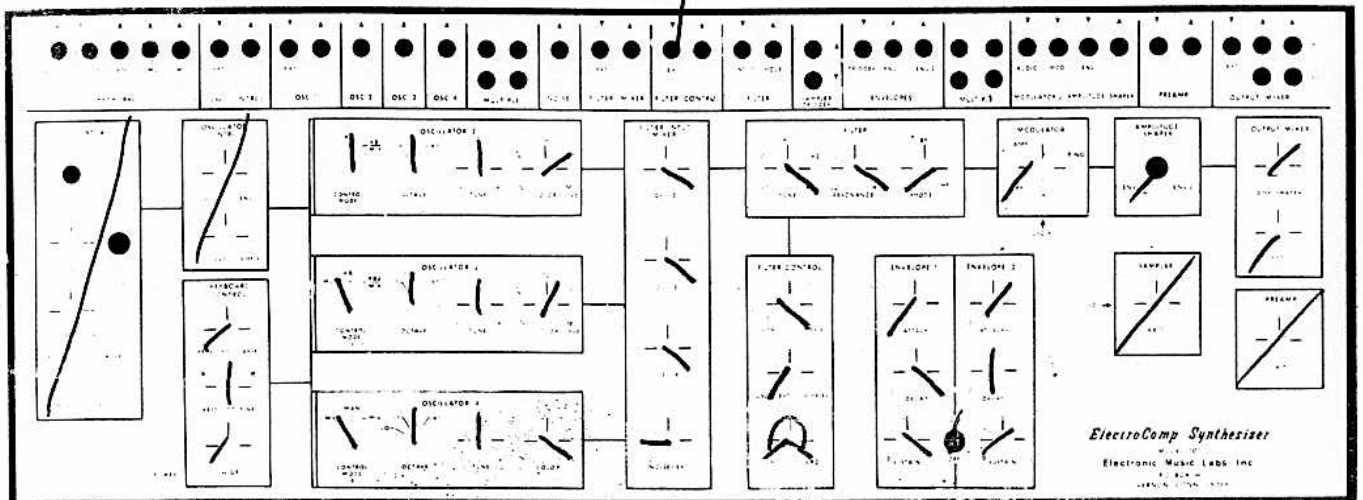
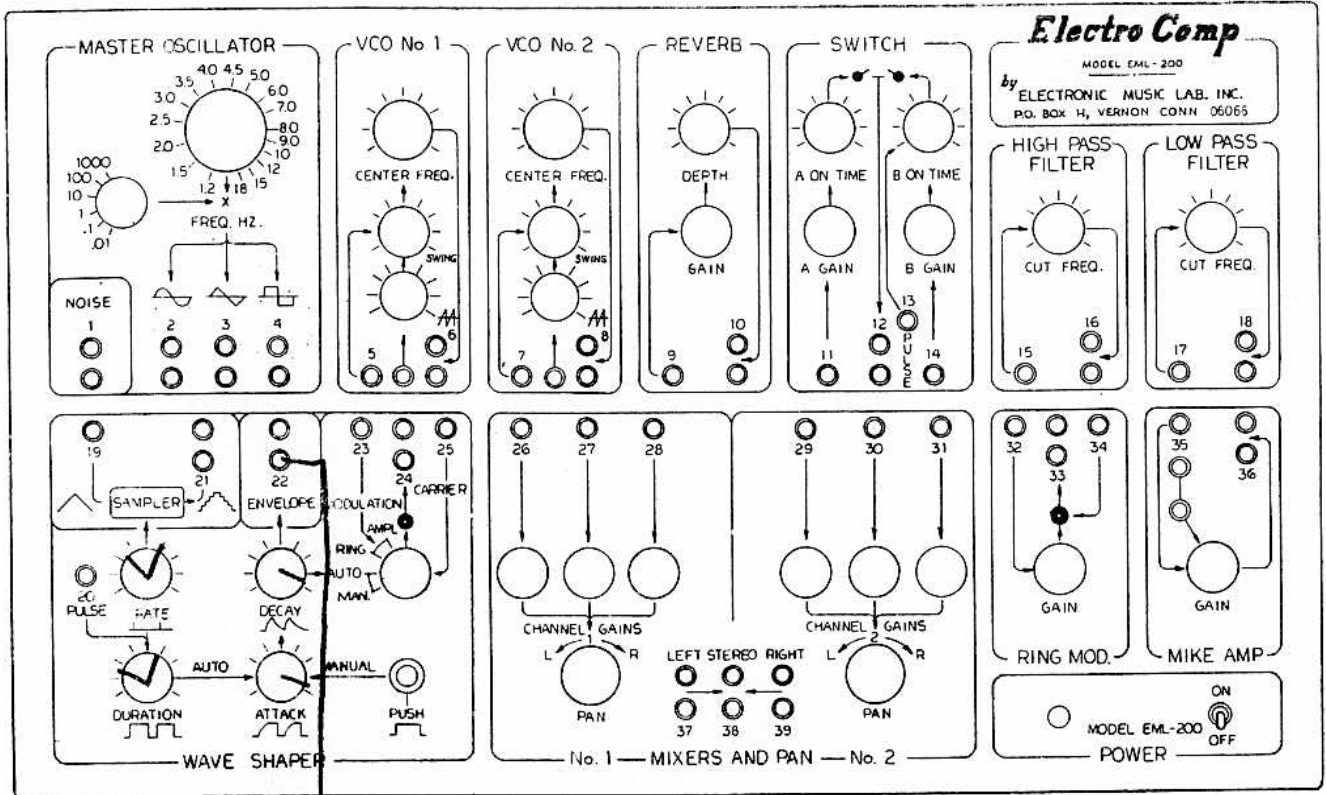

THE 200 AS BACKGROUND.

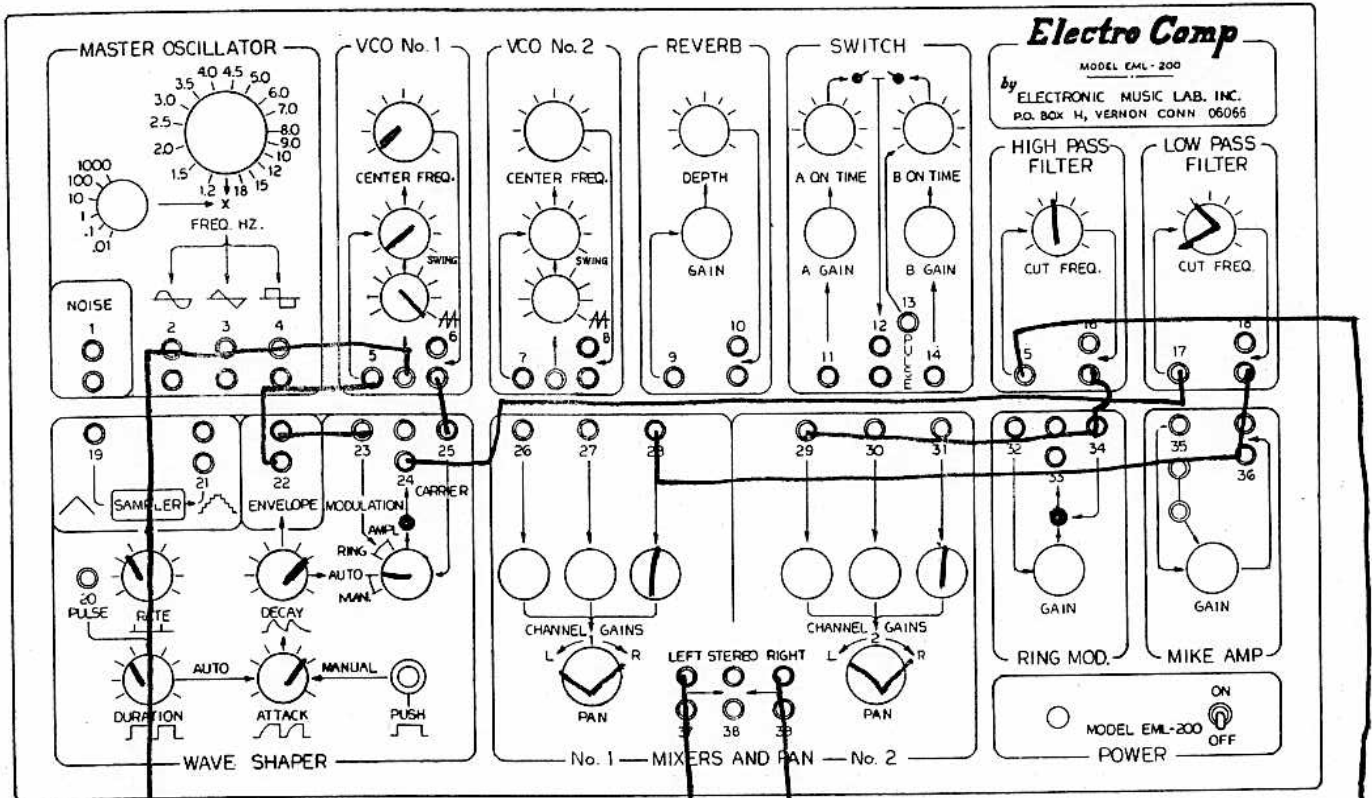

TO AMPLIFIER

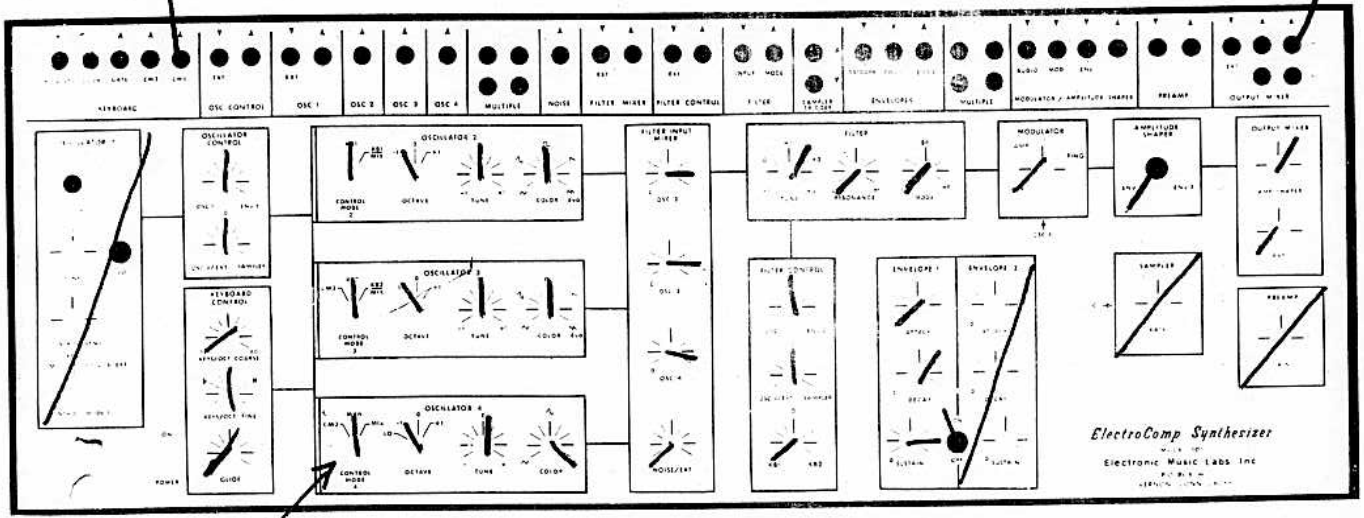

TUNE 2
CYCLES ABOVE
OSC. 2 & 3.



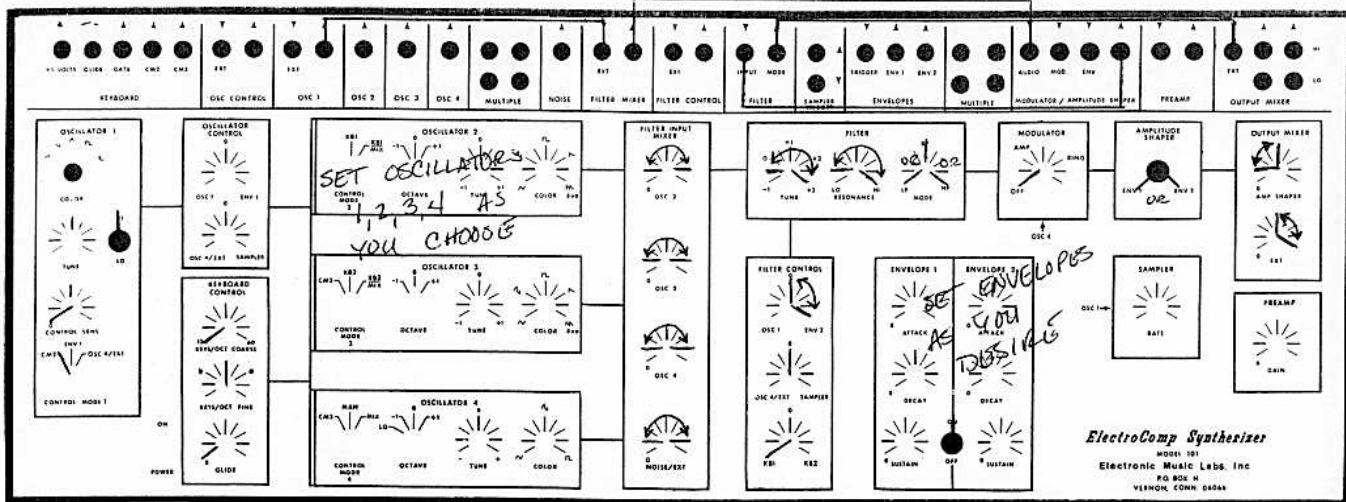

Filtered & Unfiltered Sound, Simultaneously.

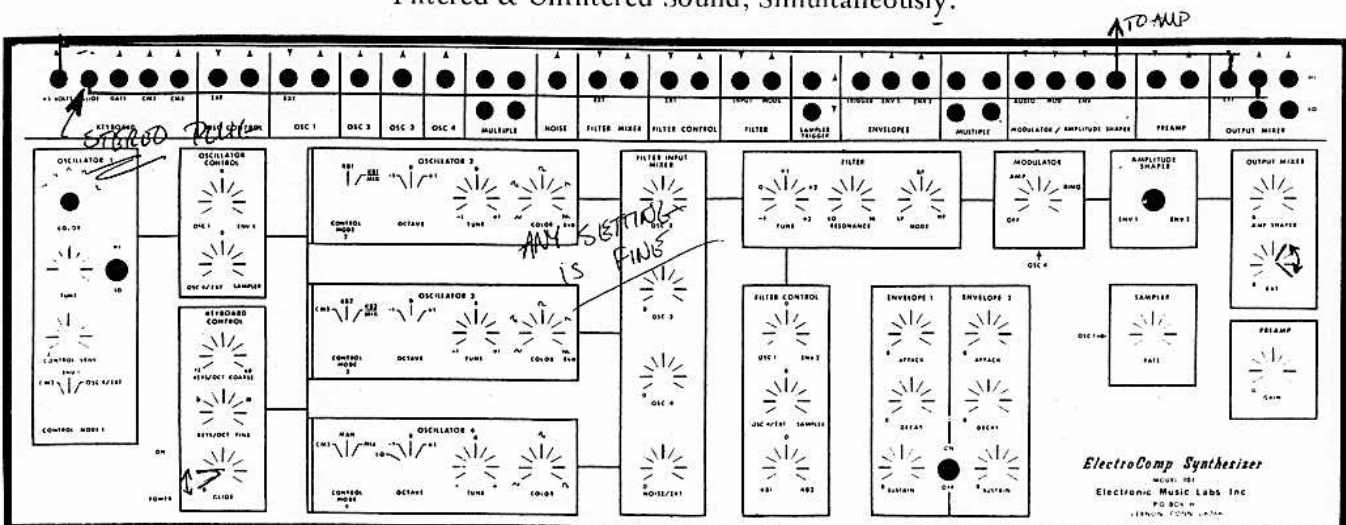

One-Way Downward Glide

Use the same procedure as "Positive One-Way" glides only, depress and hold lowest key.

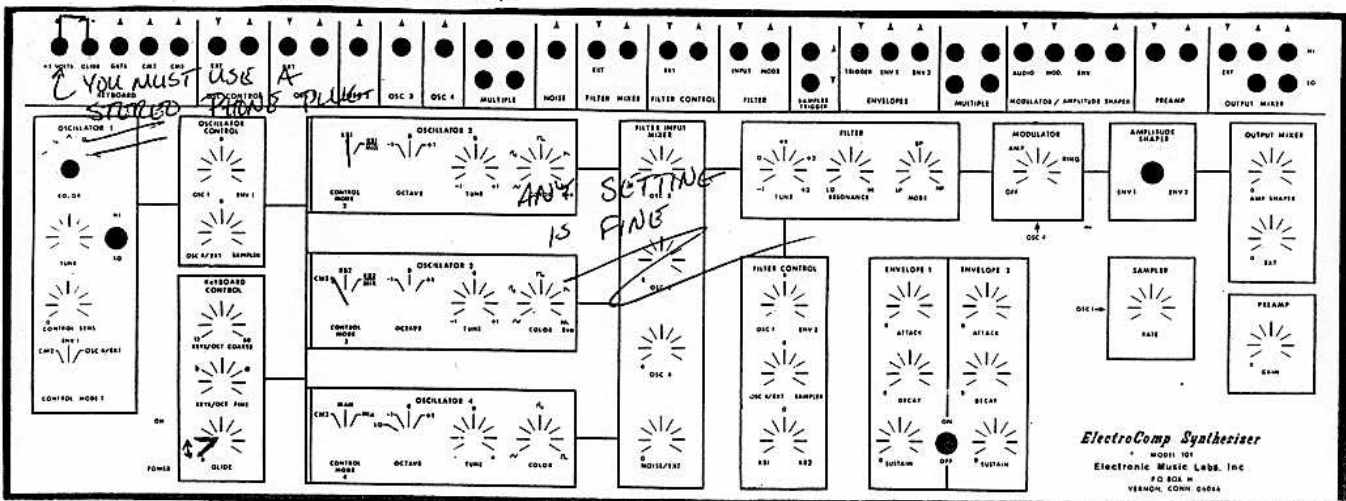

One-Way Upward Glide

Hold the highest key down and "Gently" turn the glide pot until the pitch begins to decrease then it will increase back to the pitch which corresponds to the key being depressed. You now have a positive one-way glide.

NEW EML 101 FEATURES

SEQ

The SEQ jack (▼) located in the KEYBOARD section of the patch panel is an input to interface the EML 400 Series Sequencer with the 101. This jack is employed when it is desired to control the oscillators (pitch) of the 101 from the Sequencer. When the Sequencer is inputted to the SEQ jack from the Sequencer's LIN QUAN output jack; the Sequencer will control the KB 2 oscillators - oscillators 3 and 4. Oscillators 1 and 2 remain under keyboard control. The pitches oscillators 3 and 4 produce are determined by the "Sequence" of pitches set on the EML 400 Sequencer.

Note: Oscillator 3 must be placed in the RB 2 mode and oscillator 4 in CM 3.

+ VOLTS

The VOLTS output (▲) jack located in the KEYBOARD section of the patch panel is a stereo output providing +8 volts and -6 volts. Using the optional footpedal(s) or "wheel" and patchcord, these voltages can be applied to the oscillators via the OSCILLATOR CONTROL MIXER to produce pitch bends; to the filter via the FILTER CONTROL MIXER to realize filter sweeps; and to the AMPLITUDE SHAPER via the MOD jack (▼) to vary overall dynamic changes.

With the "wheel" and a stereo patchcord (+) and (-) bends and sweeps are possible, using a mono (single ring) patchcord only (+) bends and sweeps may be realized.

EML 101 OPTIONAL ACCESSORIES

BUILT-IN-REVERB	\$100.00
FOOT PEDAL	50.00
FOOT SWITCH FOR GLIDE	22.50
TWO MOUNTED FOOT PEDALS <i>"The Peddler"</i>	90.00
TWO FOOT PEDALS AND SWITCH <i>"The Foot Loose"</i>	110.00
EML 101 T-SHIRT	5.00
"THE WHEEL"	50.00

"THE WHEEL"

INSTALLATION:

Unscrew the wood/Formica plate left of the keyboard and replace it with the "wheel" assembly. Fasten by inserting the screws and tighten.

OPERATION:

The "wheel" permits the "bending" of pitch (+) or (-), "sweeping" the filter (+) or (-), or for applying control voltages. To control pitch place the mode switch of the oscillator 2 in KB1/MIX (oscillator 3 in CM2) or oscillator 3 in KB2/MIX. Using the "wheel" as a "bender" a stereo patchcord must be connected between the + VOLT jack and the left hand jack (input) of the "wheel". The right hand jack (output) should then be connected with a patchcord to the EXT jack (▼) of the OSCILLATOR CONTROL section of the patch panel. The corresponding "pot" marked OSC4/EXT will determine "how much" bending (+) or (-) will occur. NOTE: Oscillators must be in either KB1/MIX or KB2/MIX. Moving the "wheel" forward will apply positive voltages; backward will apply negative voltage.

When the "wheel" is used as a modulation applier the modulation source is inputted to the left hand jack (input), the right hand jack is the output (amount). The output may then be patched to affect changes in pitch (oscillators), timbre (filter), and loudness (modulator/amplitude shaper).

DUAL MONO TO STEREO PATCHCORD:

The special patchcord included with the "wheel" allows one to input two independent controller voltages. For example, the mono (single ring) patchcords may be patched to Osc. 4 output and the + VOLT output. The stereo (double ring) end is inputted to the left hand (input) jack of the "wheel". Placing a patchcord between the right hand jack (output) and the EXT input of either the OSCILLATOR CONTROL or FILTER CONTROL sections of the patch panel and having the mode switches and "pots" positioned correctly, will allow you to apply either Osc. 4's voltage or + VOLTAGES to the designated function. Moving the "wheel" forward will apply one of the control voltages and moving it backwards will apply the other control voltage.

NOTE: A variety of control voltages may be applied via the "wheel" to control: voltage controlled oscillators, voltage controlled filters, and voltage controlled amplifiers (amplitude shapers). Control voltages are: envelopes, audio and sub-audio oscillators, samplers, + and - voltages, and Sequencers.

electronic music laboratories, inc.

P.O. Box H, Vernon, Connecticut 06066 Tel: (203) 875-0751