

# Digitone

Master of the digital method

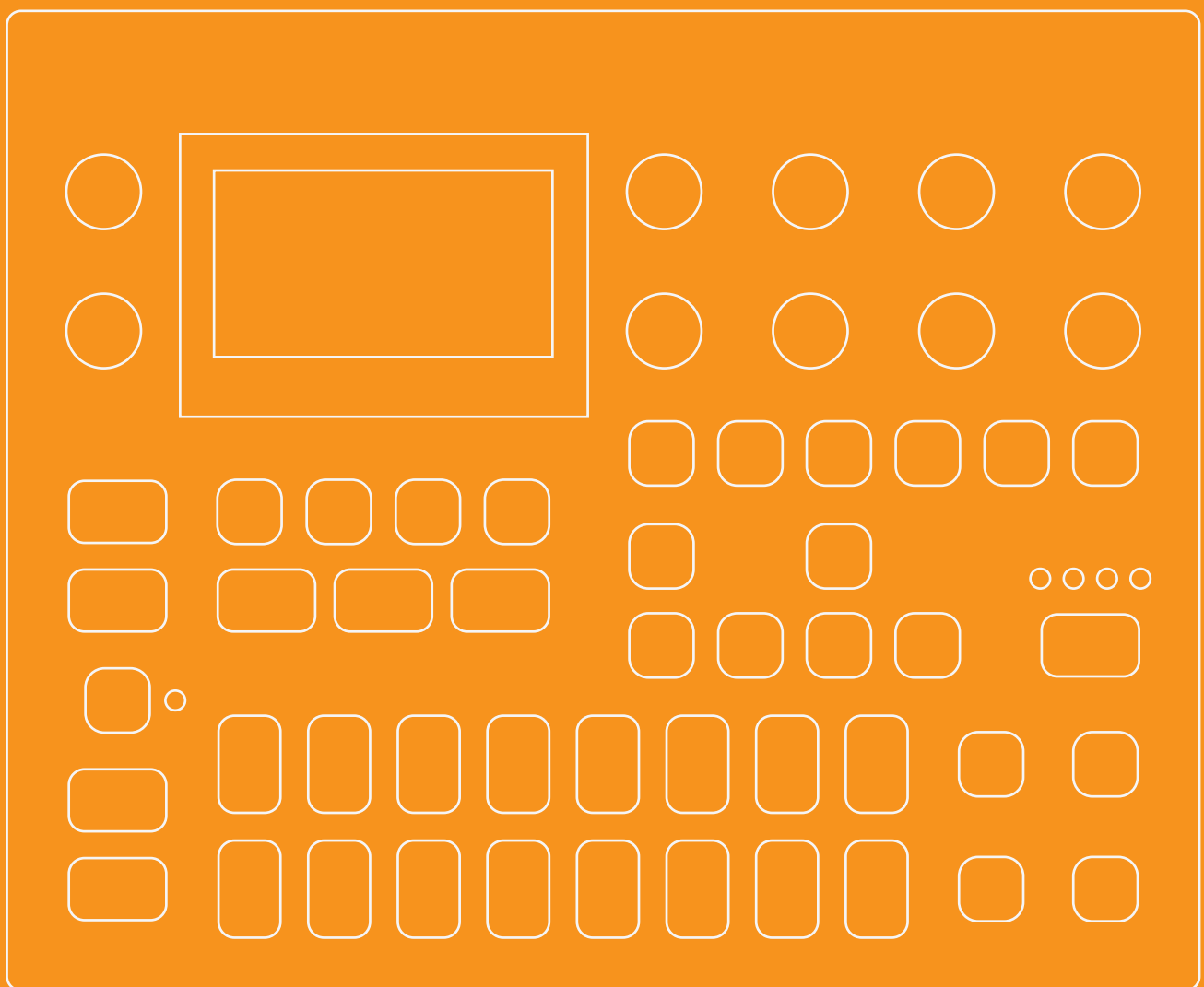

**User Manual**

### **FCC compliance statement**

This device complies with part 15 of the FCC rules. Operation is subject to the following two conditions: (1) This device may not cause harmful interference, and (2) this device must accept any interference received, including interference that may cause undesired operation.

NOTE: This equipment has been tested and found to comply with the limits for a Class B digital device, pursuant to Part 15 of the FCC Rules. These limits are designed to provide reasonable protection against harmful interference in a residential installation. This equipment generates, uses and can radiate radio frequency energy and, if not installed and used in accordance with the instructions, may cause harmful interference to radio communications. However, there is no guarantee that interference will not occur in a particular installation. If this equipment does cause harmful interference to radio or television reception, which can be determined by turning the equipment off and on, the user is encouraged to try to correct the interference by one or more of the following measures:

- Reorient or relocate the receiving antenna.
- Increase the separation between the equipment and receiver.
- Connect the equipment into an outlet on a circuit different from that to which the receiver is connected.
- Consult the dealer or an experienced radio/TV technician for help.

### **Canada**

This Class B digital apparatus complies with Canadian ICES-003.  
Cet appareil numérique de la classe B est conforme à la norme NMB-003.

### **European Union regulation compliance statement**

This product has been tested to comply with the Low Voltage Directive 2014/35/EU and the Electromagnetic Compatibility Directive 2014/30/EU. The product meets the requirements of RoHS 2 Directive 2011/65/EU.



This symbol indicates that your product must be disposed of properly according to local laws and regulations.

### **Legal disclaimer**

The information in this document is subject to change without notice and should not be construed as a commitment by Elektron. Elektron assumes no responsibility for any errors that may appear in this document. Elektron may also make improvements and/or changes in the products and programs described in this document at any time without notice. In no event shall Elektron be liable for any special, indirect, or consequential damages or any damages whatsoever resulting from loss of use, data, or profits, whether in an action of contract, negligence, or other action, arising out of or in connection with the use or performance of this information.

## **IMPORTANT SAFETY AND MAINTENANCE INSTRUCTIONS**

Please read these instructions carefully and adhere to the operating advice.

1. Do not use this unit near water.
2. Never use aggressive cleaners on the casing or on the screen. Remove dust, dirt and fingerprints with a soft, dry and non-abrasive cloth. More persistent dirt can be removed with a slightly damp cloth using only water. Disconnect all cables while doing this. Only reconnect them when the product is safely dry.
3. Install in accordance with the manufacturer's instructions. Make sure you place the unit on a stable surface before use. If you mount the unit in a rack, be sure to tighten all four screws in the rack mount holes.
4. Connect the unit to an easily accessible electrical outlet close to the unit.
5. When transporting the unit, use accessories recommended by the manufacturer or the original box and padding.
6. Do not install near any heat sources such as radiators, heat registers, stoves, or any other equipment (including amplifiers) producing heat.
7. Do not put the PL-2S Protective Cover (Elektron accessory) on the unit while the unit is powered on.
8. This product, by itself or in combination with amplifiers, headphones or speakers, is capable of producing sound levels that may cause permanent hearing loss. Do not operate at a high volume level or at a level that is uncomfortable.
9. Protect the power cord from being walked on or pinched particularly at plugs, convenience receptacles, and the point where they exit from the unit.
10. Only use attachments/accessories specified by the manufacturer.
11. Unplug this unit during lightning storms or when it is not used for long periods of time.
12. Refer all servicing to qualified service technicians. Servicing is required when the unit has been damaged in any way, liquid has been spilled or objects have fallen into the unit, the unit has been exposed to rain or moisture, does not operate normally, or has been dropped.

### **WARNING**

**To reduce the risk of fire, electrical shock or product damage:**

- Do not expose the unit to rain, moisture, dripping or splashing and also avoid placing objects filled with liquid, such as vases, on the unit.
- Do not expose the unit to direct sunlight, nor use it in ambient temperatures exceeding 40°C as this can lead to malfunction.
- Do not open the casing. There are no user repairable or adjustable parts inside. Leave service and repairs to trained service technicians only.
- Do not exceed the limitations specified in the Electrical specifications.

### **SAFETY INSTRUCTIONS FOR THE POWER ADAPTER ELEKTRON PSU-3b**

- The adapter is not safety grounded and may only be used indoors.
- To ensure good ventilation for the adapter, do not place it in tight spaces. To prevent risk of electric shock and fire because of overheating, ensure that curtains and other objects do not prevent adapter ventilation.
- Do not expose the power adapter to direct sunlight, nor use it in ambient temperatures exceeding 40°C.
- Connect the adapter to an easily accessible electrical outlet close to the unit.
- The adapter is in standby mode when the power cord is connected. The primary circuit is always active when the cord is connected to the power outlet. Pull out the cord to completely disconnect the adapter.
- In the EU, only use CE approved power cords.

### **RESTART**

- For a complete restart of the Digitone, wait for at least 30 seconds after turning it off before turning it on again.

---

**TABLE OF CONTENTS**

---

<b>1. INTRODUCTION</b> .....	<b>8</b>
1.1 CONVENTIONS IN THIS MANUAL .....	8
<b>2. THE DIGITONE</b> .....	<b>9</b>
<b>3. PANEL LAYOUT AND CONNECTORS</b> .....	<b>10</b>
3.1 FRONT PANEL .....	10
3.2 REAR CONNECTORS .....	12
3.3 SETTING UP AND STARTING THE DIGITONE .....	12
<b>4. DIGITONE SOUND ARCHITECTURE</b> .....	<b>13</b>
4.1 AUDIO VOICES .....	13
4.2 EFFECTS .....	13
<b>5. OVERVIEW OF THE DIGITONE DATA STRUCTURE</b> .....	<b>14</b>
5.1 +DRIVE .....	14
5.2 DATA STRUCTURE .....	14
5.2.1 PROJECT .....	14
5.2.2 PATTERNS .....	14
5.2.3 SOUNDS .....	14
5.3 ABOUT THE TRACKS .....	14
5.3.1 THE SYNTH TRACKS .....	14
5.3.2 THE MIDI TRACKS .....	15
5.3.3 EDITING THE TRACKS .....	15
<b>6. THE USER INTERFACE</b> .....	<b>16</b>
6.1 SCREEN NAVIGATION .....	16
6.2 PARAMETER EDITING .....	16
6.2.1 PARAMETER VALUE JUMP .....	16
6.2.2 CONTROL ALL .....	16
6.2.3 [FUNC] KEY PRESS COMBINATIONS .....	17
6.3 QUICK SCROLLING .....	17
6.4 COPY, CLEAR, AND PASTE .....	17
6.5 THE NAMING SCREEN .....	17
6.5.1 NAMING POP-UP MENU .....	17
6.6 OVERBRIDGE .....	18
<b>7. QUICK START</b> .....	<b>19</b>
7.1 PLAYING THE FACTORY PRESET PATTERNS .....	19
7.2 USING THE TRIG KEYS TO PLAY THE DIGITONE .....	19
7.3 CHANGING SOUNDS .....	19
7.4 USING MUTE MODE .....	19
7.5 TEMPO .....	19
7.6 EDITING PARAMETERS .....	20
<b>8. DIGITONE CONTROLS</b> .....	<b>21</b>
8.1 TRIG KEYS .....	21
8.2 ROTARY ENCODERS .....	21
8.3 KEY BEHAVIOR .....	21
8.4 MIDI NOTES .....	21
8.5 MODES .....	21
8.5.1 CHROMATIC MODE .....	21
8.5.2 MUTE MODE .....	21

---

---

<b>9. PATTERNS AND SOUNDS</b> .....	<b>23</b>
<b>9.1 THE +DRIVE SOUND LIBRARY AND THE SOUND POOL</b> .....	<b>23</b>
9.1.1 ADDING SOUNDS TO THE SOUND POOL .....	23
<b>9.2 PLAYING A SOUND</b> .....	<b>23</b>
<b>9.3 EDITING A SOUND</b> .....	<b>23</b>
<b>9.4 SAVING A SOUND</b> .....	<b>24</b>
9.4.1 SAVING A SOUND TO THE +DRIVE .....	24
9.4.2 SAVING A SOUND TO THE SOUND POOL .....	24
<b>9.5 SOUND SETUP MENU</b> .....	<b>24</b>
9.5.1 KEY SCALING A .....	24
9.5.2 KEY SCALING B1 .....	25
9.5.3 KEY SCALING B2 .....	25
9.5.4 FILTER KEYTRACK .....	25
9.5.5 VELOCITY TO VOL .....	25
9.5.6 PITCH BEND DEPTH .....	25
9.5.7 OCTAVE .....	25
9.5.8 PITCH BEND .....	25
9.5.9 VELOCITY MOD .....	25
9.5.10 MOD WHEEL .....	25
9.5.11 BREATH CONTROLLER .....	26
9.5.12 AFTERTOUCHE .....	26
<b>9.6 ARPEGGIATOR MENU</b> .....	<b>26</b>
9.6.1 MODE .....	26
9.6.2 SPD .....	26
9.6.3 RNG .....	26
9.6.4 LEN .....	26
9.6.5 ARP LENGTH .....	26
9.6.6 OFFSET .....	26
<b>10. THE SEQUENCER</b> .....	<b>27</b>
<b>10.1 BASIC PATTERN OPERATIONS</b> .....	<b>27</b>
10.1.1 SELECTING BANK AND PATTERN .....	27
10.1.2 PATTERN CONTROL .....	27
10.1.3 PATTERN TEMPO .....	27
<b>10.2 CREATING AND EDITING A PATTERN</b> .....	<b>27</b>
10.2.1 TRIG TYPES .....	27
10.2.2 GRID RECORDING MODE .....	28
10.2.3 GRID RECORDING USING TRACK NOTE METHOD .....	28
10.2.4 GRID RECORDING USING QUICK NOTE METHOD .....	29
10.2.5 LIVE RECORDING MODE .....	29
<b>10.3 TRIG PARAMETERS</b> .....	<b>30</b>
<b>10.4 TRACK NOTE MENU</b> .....	<b>30</b>
<b>10.5 VOICE MENU</b> .....	<b>30</b>
<b>10.6 MICRO TIMING MENU</b> .....	<b>31</b>
<b>10.7 PATTERN MENU</b> .....	<b>32</b>
10.7.1 QUANTIZE .....	32
10.7.2 RENAME .....	32
10.7.3 CLEAR .....	32
10.7.4 SAVE TO PROJ .....	32
10.7.5 RELOAD FROM PROJ .....	33
10.7.6 IMPORT/EXPORT .....	33
<b>10.8 METRONOME MENU</b> .....	<b>33</b>
<b>10.9 SCALE MENU</b> .....	<b>33</b>

---

10.9.1 LENGTH PER PATTERN MODE .....	33
10.9.2 LENGTH PER TRACK MODE .....	34
<b>10.10 SEQUENCER FEATURES .....</b>	<b>34</b>
10.10.1 PARAMETER LOCKS .....	34
10.10.2 SOUND LOCKS .....	35
10.10.3 CONDITIONAL LOCKS .....	35
10.10.4 FILL MODE .....	36
10.10.5 SWING .....	36
10.10.6 COPY, PASTE AND CLEAR OPERATIONS .....	36
10.10.7 TEMPORARY SAVE AND RELOAD PATTERN COMMANDS .....	37
10.10.8 DIRECT TRACK TRANSPOSE .....	37
10.10.9 DIRECT PATTERN TRANSPOSE .....	37
<b>10.11 CHAINS .....</b>	<b>37</b>
10.11.1 CREATING A CHAIN .....	38
<b>11. SYNTH TRACK PARAMETERS .....</b>	<b>39</b>
11.1 EDITING THE SYNTH TRACK PARAMETERS .....	39
11.2 TRIG PARAMETERS PAGE 1 .....	39
11.3 SYN1 PAGE 1 .....	39
11.4 SYN 2 PAGE 1 .....	40
11.5 SYN2 PAGE 2 .....	41
11.6 FLTR PAGE 1 .....	43
11.7 FLTR PAGE 2 .....	44
11.8 AMP PAGE 1 .....	45
11.9 AMP PAGE 2 .....	45
11.10 LFO PAGE 1 .....	46
11.11 LFO PAGE 2 .....	47
<b>12. MIDI TRACK PARAMETERS .....</b>	<b>49</b>
12.1 EDITING THE MIDI TRACK PARAMETERS .....	49
12.2 TRIG PARAMETERS PAGE .....	49
12.3 SYN1 PAGE (MIDI SOURCE) .....	49
12.4 FLTR PAGE (CC VALUE) .....	50
12.5 AMP PAGE (CC SELECT) .....	50
12.6 LFO PAGE .....	51
<b>13. FX PARAMETERS .....</b>	<b>53</b>
13.1 EDITING THE FX PARAMETERS .....	53
13.2 CHORUS .....	53
13.3 DELAY .....	53
13.4 REVERB .....	55
13.5 MASTER .....	55
<b>14. GLOBAL SETTINGS MENU .....</b>	<b>57</b>
14.1 PROJECT .....	57
14.1.1 LOAD PROJECT .....	57
14.1.2 SAVE PROJECT AS .....	57
14.1.3 MANAGE PROJECTS .....	57
14.2 SOUNDS .....	57
14.2.1 SOUND BROWSER .....	58
14.2.2 SOUND MANAGER .....	59
14.2.3 CLEAR TRACK SOUND .....	60
14.2.4 RENAME TRACK SOUND .....	60

---

---

14.2.5 SETUP .....	60
<b>14.3 MIDI CONFIG .....</b>	<b>60</b>
14.3.1 SYNC .....	60
14.3.2 PORT CONFIG .....	61
14.3.3 CHANNELS .....	62
<b>14.4 SYSEX DUMP .....</b>	<b>63</b>
14.4.1 SYSEX SEND .....	63
14.4.2 SYSEX RECEIVE .....	63
<b>14.5 SYSTEM .....</b>	<b>64</b>
14.5.1 USB CONFIG .....	64
14.5.2 OS UPGRADE .....	64
14.5.3 FORMAT +DRIVE .....	65
<b>15. STARTUP MENU .....</b>	<b>66</b>
15.1 TEST MODE .....	66
15.2 EMPTY RESET .....	66
15.3 FACTORY RESET .....	66
15.4 OS UPGRADE .....	66
15.5 EXIT .....	66
<b>16. SETUP EXAMPLES .....</b>	<b>67</b>
16.1 DIGITONE WITH A MONOPHONIC BASS MACHINE .....	67
16.2 DIGITONE TOGETHER WITH THE DIGITAKT .....	67
16.3 CONTROLLING A SYNTHESIZER USING THE MIDI TRACKS .....	68
<b>17. USEFUL KEY COMBINATIONS .....</b>	<b>70</b>
<b>18. TECHNICAL INFORMATION .....</b>	<b>72</b>
<b>19. CREDITS AND CONTACT INFORMATION .....</b>	<b>72</b>
<b>APPENDIX A: THE DIGITONE FM SYNTHESIS .....</b>	<b>73</b>
A.1 OVERVIEW .....	73
A.2 THE OPERATORS .....	73
A.3 ALGORITHMS .....	74
A.4 FM RATIOS .....	74
A.5 THE OPERATOR ENVELOPES .....	75
A.6 HARMONICS .....	76
A.7 SYN1 PAGE 1 PARAMETERS OVERVIEW .....	77
<b>APPENDIX B: MIDI IMPLEMENTATION .....</b>	<b>79</b>
B.1 TRACK PARAMETERS .....	79
B.2 TRIG PARAMETERS .....	79
B.3 FM PARAMETERS .....	79
B.4 FILTER PARAMETERS .....	80
B.5 AMP PARAMETERS .....	80
B.6 LFO PARAMETERS .....	80
B.7 FX PARAMETERS .....	81
<b>INDEX .....</b>	<b>83</b>

---

## 1. INTRODUCTION

---

### 1.1 CONVENTIONS IN THIS MANUAL

We use the following text formatting conventions throughout the manual:

- **KEY NAMES**  
Uppercase, bold style and within brackets. For instance, the key labeled “FUNC” on the main panel is called **[FUNC]**.
- **KNOBS**  
Uppercase, bold, italic letters. For instance, the knob “Level/Data” is called ***LEVEL/DATA***.
- **LED INDICATORS**  
Uppercase letters with angle brackets. For instance, the Pattern page LEDs are called: **<PATTERN PAGE>**.
- **MENU NAMES**  
Uppercase letters. The GLOBAL SETTINGS menu is an example of that.
- **PARAMETER NAMES, MENU OPTIONS**  
Uppercase bold letters for parameter names and certain menu options where you can make settings or perform actions. For example, **VOL**.
- **PARAMETER SETTING ALTERNATIVES**  
Uppercase letters. For example, **OFF**.
- **SCREEN MESSAGES**  
Uppercase letters with quotation marks. For example, **“QUANTIZE LIVE REC”**.

You also find the following symbols throughout the manual:



Important information that requires your attention.



A tip that makes it easier for you to interact with the Digitone.



## 2. THE DIGITONE

---

FM synthesis is a very powerful synthesis method, discovered and pioneered by John Chowning in the late 1960's. The metallic, yet oddly natural sounds generated by this new method quickly became popular, and just a little bit more than a decade after Chowning's discovery, they could be heard all over the Billboard charts. FM sounds elevated songs by Michael Jackson, Lionel Richie, the Cure, Queen, too many to mention really. It was the sound of the times.

The first all-digital Elektron products, Machinedrum and Monomachine, both featured simplified FM implementations. FM synthesis is known for being difficult to program, and we wanted to make it more accessible. When we began designing Digitone, we had a similar mindset, but this time we wanted to go much further. Our ambition was to offer the full depth of FM synthesis but modernize it, streamline it, make it more elegant. In a sense, we wanted to expand the notion of what FM synthesis could be and mean. And so our work began.

Using Digitone is somewhat of an adventure. Twist a knob and hear how the sound changes and becomes animated. A crystal-like bell sound turns into a tense, crackling drone, which seconds later morphs into a soothing pad. Digitone offers a unique approach to sound design and invites you to experiment. It is an endless source of both familiar and other-worldly sounds. A glorious theme park located in an uncanny valley.

Digitone is maybe the most unique synthesizer we have ever created. We hope you will enjoy it.

Sincerely,



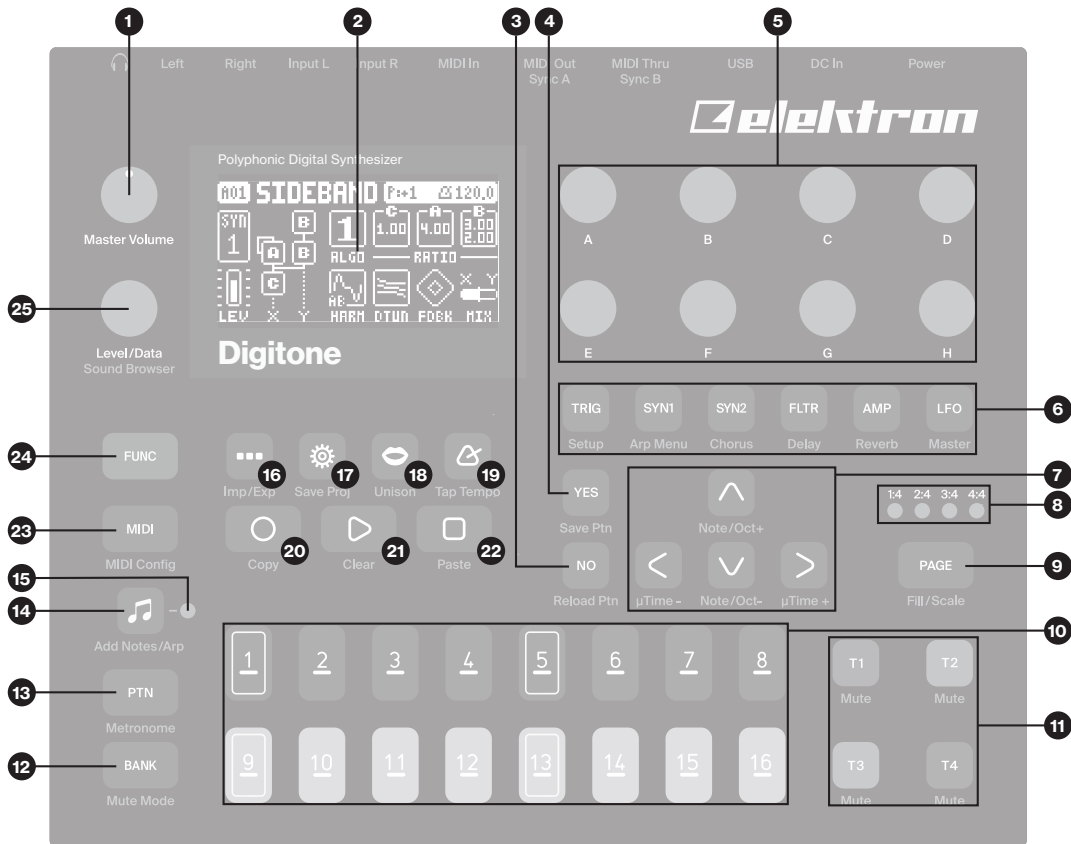

The Elektron Team

## 3. PANEL LAYOUT AND CONNECTORS

### 3.1 FRONT PANEL



1. **MASTER VOLUME** sets the volume for the main outputs and the headphones output.
2. Screen.
3. **[NO]** key. Used for exiting an active menu, backing one step and negating. The secondary function is a temporary reload of the active pattern.
4. **[YES]** key. Used for entering sub-menus, selecting and confirming. The secondary function is a temporary save of the active pattern.
5. **DATA ENTRY** knobs **A-H**. Used for setting parameter values. Press and turn the knobs to change values in larger increments.
6. **[PARAMETER]** keys access the **PARAMETER** pages of the active track. The color of the keys indicates if the page is active (red/blue) or inactive (off).
  - **[TRIG PARAMETERS]** accesses parameters such as **NOTE**, **VELOCITY**, and other trig related parameters. The secondary function accesses the **SOUND SETUP** menu.
  - **[SYN1]** accesses the **SYN1** pages. Here you can find parameters related to the **FM** engine. For **MIDI** tracks this page has parameters such as **CHANNEL**, **PROGRAM**, and **AFTERTOUCH**. The secondary function accesses the **ARPEGGIATOR** menu.
  - **[SYN2]** accesses the **SYN2** pages. Here you can find further parameters related to the **FM** engine. The secondary function accesses the **CHORUS** page.
  - **[FLTR]** accesses the **FILTER** pages. Here are the parameters for the base-width and multimode filters. On **MIDI** tracks you find the **CC** value settings here. The secondary function accesses the **DELAY** page.
  - **[AMP]** takes you to the **AMP** page, where you find parameters for the amplitude envelope and effect sends. On **MIDI** tracks you find the **CC** select settings here. The secondary function accesses the **REVERB** page.
  - **[LFO]** accesses the **LFO** parameters for both synth and **MIDI** tracks. The secondary function accesses the **MASTER** page.
7. The **[ARROW]** keys. Used for navigation and for setting parameter values. In menus, they are called **[UP]**, **[DOWN]**, **[LEFT]**, and **[RIGHT]**.

8. <PATTERN PAGE> LEDs indicate how many pattern pages the active pattern consists of and which pattern page is currently active. The LED flashes on the pattern page that is currently playing.
9. [PAGE] selects the active pattern page, if the pattern has more than 16 steps. The <PATTERN PAGE> LEDs indicate how many pattern pages the active pattern consists of and which pattern page is currently active. The LED flashes on the pattern page currently playing. The secondary function accesses the SCALE menu. This key also activates Fill Mode (when GRID RECORDING mode is not active).
10. [TRIG] keys enter or remove sequencer trigs, and parameter locks, in combination with the *DATA ENTRY* knobs. They also select, banks, and patterns, in combination with the [PTN], and [BANK] keys. The [TRIG] keys also function as a keyboard to play the Digitone or to input notes to the sequencer. The [TRIG] keys lights indicate trigs on the sequencer by lit red keys, while flashing red keys indicates parameter locks, in GRID RECORDING mode. When a pattern is playing, or when LIVE RECORDING is enabled, a light “runs” along the 16 steps of the sequencer across all (up to four) pages at the set tempo.
11. [TRACK] keys. Selects which track to be active. The secondary function mutes the track.
12. [BANK] selects bank A–H in combination with the [TRIG 9–16] keys. The secondary function accesses the MUTE Mode.
13. [PTN] selects pattern 1–16 in combination with the [TRIG 1–16] keys. The secondary function opens the METRONOME menu.
14. [TRACK NOTE]  opens the TRACK NOTE menu where you can view and edit note related settings such as transpose, scale, and chords. The secondary function toggles the arpeggiator on and off. This key is also used to add notes in the sequencer (when in GRID RECORDING mode).
15. <ARPEGGIATOR> LED indicates the arpeggiator’s on/off status.
16. [PATTERN MENU]  opens the PATTERN menu, where you find pattern management. The secondary function accesses the Import/Export menu.
17. [GLOBAL SETTINGS]  contains the management of projects, MIDI configuration, and the System settings.  
The secondary function saves the current project.
18. [VOICE]  opens the VOICE menu where you handle the track’s voice allocation.  
The secondary function accesses the UNISON menu.
19. [TEMPO]  opens the TEMPO menu where you can adjust the global/pattern tempo and also adjust the swing. The secondary function makes it possible to tap the tempo.
20. [RECORD] key. Activates/deactivates GRID RECORDING mode. Press and hold [RECORD], and then press [PLAY], to activate LIVE RECORDING mode. Press and hold [RECORD], and then press [PLAY] twice to activate/deactivate quantized LIVE RECORDING. The secondary function is a copy operation.
21. [PLAY] starts the sequencer playback. The secondary function is a clear operation.
22. [STOP] stops playback. The secondary function is a paste operation.
23. [MIDI] activates the MIDI editing mode where you can edit the MIDI tracks. A lit [MIDI] key indicates the MIDI editing mode is active. The secondary function opens the MIDI CONFIG menu.
24. [FUNC] key. Press and hold [FUNC], and then press another key to access the secondary function of that key. The blue-green text on the Digitone front panel shows the keys secondary functions.
25. LEVEL/DATA sets the overall volume level of the active track. You can also set parameters and scroll through lists. The secondary function opens the SOUND BROWSER.

#### 3.2 REAR CONNECTORS

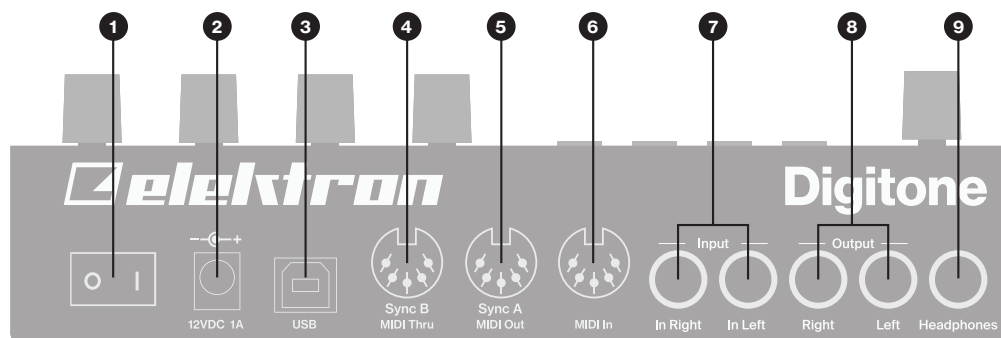

1. **POWER** Switch for turning the unit on and off.
2. **DC In** Input for power supply. Use the included PSU-3b power adapter, connected to a power outlet.
3. **USB** For connecting the unit to a computer. For MIDI-control or Overbridge use. Use the included A to B USB 2.0 connector cable to connect to a computer host.
4. **MIDI THRU/SYNC B**, Forwards data from MIDI IN. Can also be configured to send DIN sync to legacy instruments. Use a standard MIDI cable to connect another MIDI device in the chain.
5. **MIDI OUT/SYNC A**, MIDI data output. Can also be configured to send DIN sync to legacy instruments. Use a standard MIDI cable to connect to MIDI In of an external MIDI device.
6. **MIDI IN**, MIDI data input. Use a standard MIDI cable to connect to MIDI Out of an external MIDI device.
7. **INPUT L/R**, Audio inputs. Use a 1/4" mono phone plug (unbalanced connection).
8. **OUTPUT L/R**, Main audio outputs. Use either 1/4" mono phone plug (unbalanced connection) or 1/4" Tip/Ring/Sleeve phone plug (balanced connection).
9. **HEADPHONES**, Audio output for stereo headphones. Use 1/4" Tip/Ring/Sleeve phone plug.

#### 3.3 SETTING UP AND STARTING THE DIGITONE

Make sure you place the Digitone on a stable support, such as a sturdy table, with sufficient space for the cables. Make sure to switch off all devices before you connect the Digitone to other devices.

1. Plug the supplied DC adapter into a power outlet and connect the small plug to the 12 V DC In on the Digitone.
2. Connect OUTPUT L/R from the Digitone to your mixer or amplifier.
3. To control the Digitone from a computer, connect a USB cable between the computer and the USB connector of the Digitone.
4. If you want to use MIDI to control the Digitone, connect the MIDI OUT port of the device you wish to send data from to the MIDI IN port of the Digitone. The MIDI THRU port duplicates the data arriving at the MIDI IN port so that it can forward data to other MIDI units. Connect the MIDI OUT port of the Digitone to the MIDI IN port of the device you want to control if you want to use Digitone to control other devices using MIDI.
5. Connect an audio source to INPUT L/R or via USB if you want to process audio from external sources.
6. Switch on all units. Press the POWER switch located at the back of the Digitone to switch it on.

## 4. DIGITONE SOUND ARCHITECTURE

The illustrations below show the Digitone sound architecture, with its eight audio voices, three send effects (chorus, delay, and reverb) and master effect (overdrive).

### 4.1 AUDIO VOICES

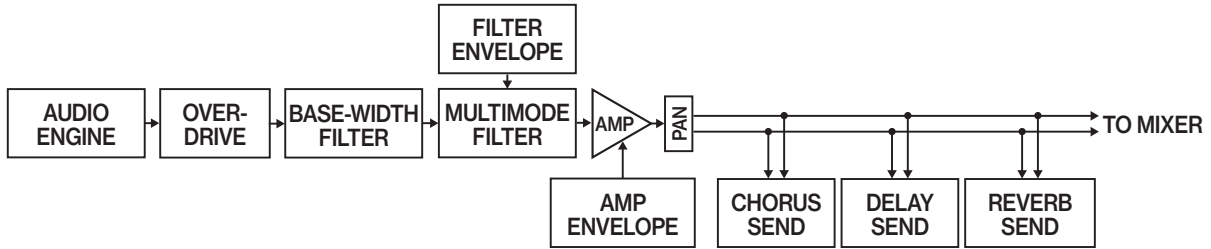

### 4.2 EFFECTS

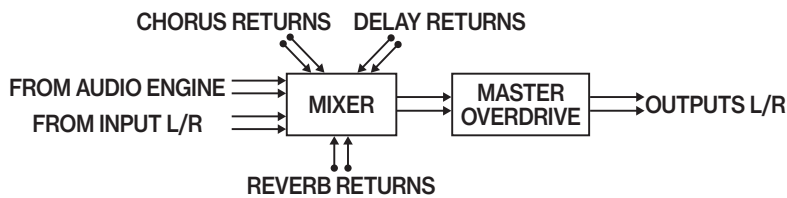
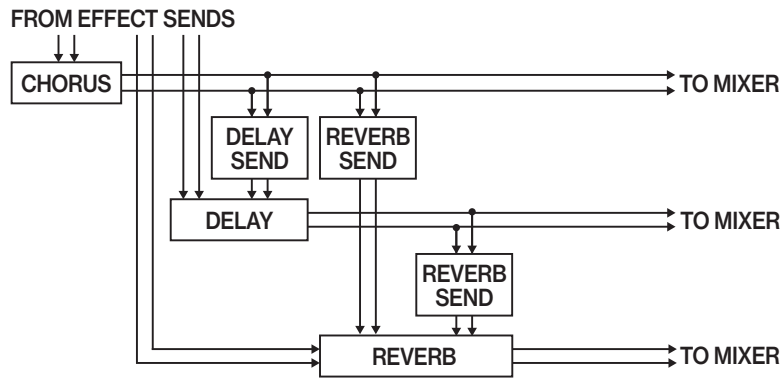

## 5. OVERVIEW OF THE DIGITONE DATA STRUCTURE

The illustration below outlines the Digitone's data structures.

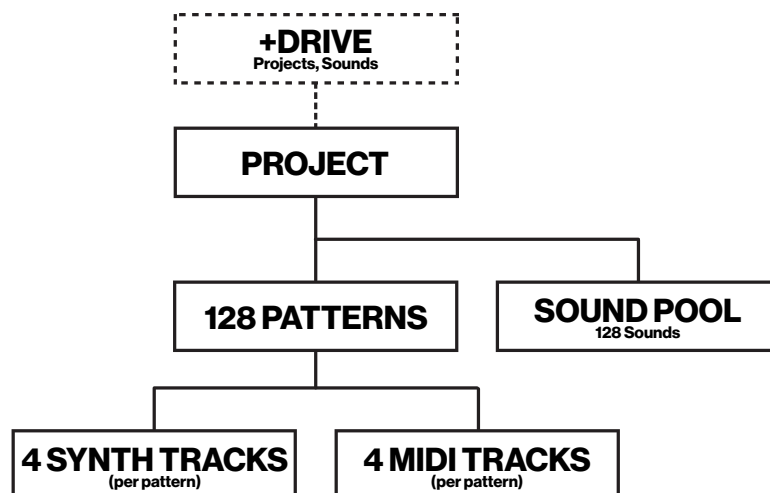

### 5.1 +DRIVE

The +Drive is a non-volatile memory capable of storing up to 128 projects. The +Drive also holds +Drive Sound library, with the capacity of storing 2048 Sounds. Every project has access to these Sounds.

### 5.2 DATA STRUCTURE

#### 5.2.1 PROJECT

A project contains 128 patterns. The project also stores general settings and states. The currently loaded project becomes the active working state of the Digitone. From here it is possible to edit the patterns and Sounds of the project. Every time the Digitone is switched on, it boots to the active working state, the active project. Projects are saved, loaded and managed in the GLOBAL SETTINGS menu. For more information, please see "14. GLOBAL SETTINGS MENU" on page 57.

#### 5.2.2 PATTERNS

The patterns are the primary data container for the Digitone. 16 patterns are available for each of the eight banks, which means that 128 patterns are available for each project. A pattern contains up to four sounds (one for each synth track), sequencer data like trigs and parameter locks. It also contains the settings on the TRIG page and BPM, length, swing and time signature settings. The pattern also contains all the parameter settings for the four MIDI tracks. For more information, please see "10. THE SEQUENCER" on page 27.

#### 5.2.3 SOUNDS

A Sound is a collection of the synth track settings in the SYN1, SYN2, FLTR, AMP, and LFO PARAMETER pages. Sounds can be stored either in the Sound pool of the active project or the +Drive Sound library. The Sound pool holds up to 128 Sounds and the +Drive library holds up to 2048 Sounds. You can use the SOUND MANAGER to manage sounds. For more information, please see "14.2.2 SOUND MANAGER" on page 59, "9. PATTERNS AND SOUNDS" on page 23, and "11. SYNTH TRACK PARAMETERS" on page 39.



A Sound imported to a pattern, becomes an independent copy of the Sound on the +Drive and is not linked to the original Sound on the +Drive. Instead, it becomes a part of the pattern.

### 5.3 ABOUT THE TRACKS

#### 5.3.1 THE SYNTH TRACKS

The Digitone has four synth tracks. Each synth track holds one Sound. The Sound contains the settings in the PARAMETER pages (SYN1, SYN2, FLTR, AMP, and LFO) together with the settings in the SOUND SETUP menu and the ARPEGGIATOR menu.

Press one of the [TRACK 1-4] keys to select which synth track to edit.

### 5.3.2 THE MIDI TRACKS

The Digitone also has four MIDI tracks. They are used to control external MIDI equipped gear. Each MIDI track can trigger a chord of up to eight notes with adjustable parameters such as velocity and length, control pitch bend and aftertouch, as well as eight freely assignable MIDI control change parameters (MIDI CCs). For more information, please see “12. MIDI TRACK PARAMETERS” on page 49. A MIDI track can have any MIDI channel assigned to it, and several tracks can share the same channel. If several tracks are assigned to the same MIDI channel the track with the lowest number has priority regarding parameter conflicts.

The MIDI tracks function almost the same way as the synth tracks. Parameter locks, LFO modulation, copy and paste commands are available. Each MIDI track also features micro timing, individual track length, and time signature settings. The main difference is that the MIDI tracks do not generate any sound and the sequencer data instead transmits through the MIDI OUT or USB ports.

Press the **[MIDI]** key and then press one of the **[TRACK 1–4]** keys to select which MIDI track to edit.

### 5.3.3 EDITING THE TRACKS

The six **[PARAMETER]** keys open parameter pages which is where you edit the tracks.

- The TRIG page contains different parameters such as **NOTE, VELOCITY, TRIG CONDITION** and other trig related parameters. The TRIG page parameters are not saved as a part of the Sound but as a part of the pattern.
- The SYN1 page hosts the parameters that controls various parameters of the FM synthesis. For MIDI tracks, this page contains parameters such as **CHANNEL, PROGRAM, and AFTERTOUC**H.
- The SYN2 page controls further parameters of the FM synthesis.
- On the FLTR page, you find parameters for the for the bandpass and multimode filters. On MIDI tracks you find the CC value settings here.
- The AMP page for synth tracks hosts parameters for the amplitude envelope and effect sends. On MIDI tracks you find the CC select settings here.
- Finally, the LFO page hosts LFO parameters for the active track.

Use the DATA ENTRY knobs A-H to edit the corresponding parameters. Press and turn a knob to adjust its parameter in larger increments. Press and hold a **[PARAMETER]** key to see the values for all parameters on that page. For more information, please see “11. SYNTH TRACK PARAMETERS” on page 39, and “12. MIDI TRACK PARAMETERS” on page 49.

## 6. THE USER INTERFACE

The screen shows all the information needed for real-time interaction and editing on the Digitone. The eight **DATA ENTRY** knob parameters shown varies depending on which parameter page you have selected. Below is the main interface screen of the SYN1 page.

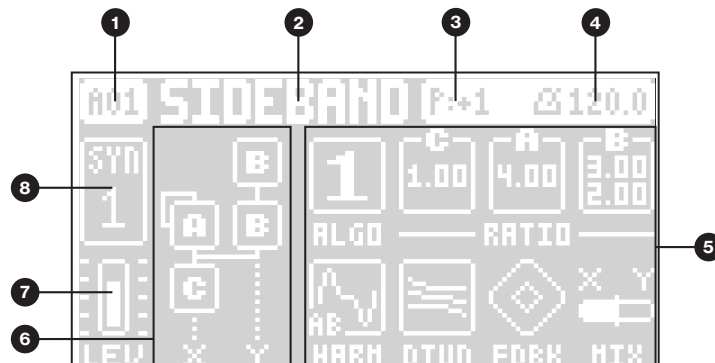

1. Bank and pattern.
2. Pattern name.
3. Pattern/Track transpose.
4. Tempo.
5. Eight track parameters. They show what parameters the **DATA ENTRY** knobs control and the current parameter values.
6. FM algorithm (Displayed on the SYN1 and SYN2 pages).
7. Track volume level. Use the **LEVEL/DATA** knob to change the level.
8. Track number and track type. Synth (SYN) track or MIDI (MID) track.

### 6.1 SCREEN NAVIGATION

Use the [ARROW] keys [UP], [DOWN], [LEFT] or [RIGHT] to navigate menus or sub-menus. The **LEVEL/DATA** knob is used to scroll through menus and lists quickly.

[YES] is used to affirm, select, enter sub-menus and tick/untick boxes.

[NO] is used to negate, deselect or go back one or more steps.



When in a menu or sub-menu, the [NO] key can be used to go back, one step at a time, all the way to the main screen.

### 6.2 PARAMETER EDITING

The **DATA ENTRY** knobs are used to change the values of the track parameters. The positions of the parameters on the screen correspond to the physical locations of the knobs on the front panel. Some of the parameters on the screen tell you what **DATA ENTRY** knob controls that particular parameter. For example "(E)."

- The parameters are adjusted in larger increments if you press down the **DATA ENTRY** knob while turning it. This function makes it quicker to sweep through the whole parameter range.
- Press **DATA ENTRY** knob + [NO] to reset the parameter to the default value.
- Press [PARAMETER] + [PLAY] to reset all the parameters on the selected parameter page to default values.
- Press and hold a [PARAMETER] key to see the values for all parameters on that PARAMETER page.

#### 6.2.1 PARAMETER VALUE JUMP

Pressing [FUNC] while editing certain parameters makes the parameter values jump to appropriate positions. The time of the Delay, for example, jumps between 16, 32, 64 and 128 and the sample tuning jumps whole octaves.

#### 6.2.2 CONTROL ALL

If you press and hold [MIDI] and change a parameter setting, this change affects this parameter in all the synth tracks in the pattern.



### 6.2.3 [FUNC] KEY PRESS COMBINATIONS

The standard way to use the [FUNC] key in combination with other keys, is to press and hold [FUNC] and then press the second key in the combination. For some key combinations, it is also possible to access a sub-menu by pressing and holding [FUNC] + second key for a second.

## 6.3 QUICK SCROLLING

Scroll through menus using the *LEVEL/DATA* knob. Quick scrolling is possible on many menus. Press [FUNC] + the [UP] or [DOWN] keys to move the cursor one menu page.

## 6.4 COPY, CLEAR, AND PASTE

Copy, clear and paste commands are available in many contexts. Press [FUNC] + [RECORD] to copy. Press [FUNC] + [STOP] to paste. Press [FUNC] + [PLAY] to clear. Repeat the key press combination to undo the paste and clear operations. Please see the different sections in the manual for more information on when these commands are available.



The copy clipboard can only hold one item at a time. When you perform a copy command, the item copied replaces any earlier copied items. For example, you can not have both a trig and a pattern copied at the same time.

## 6.5 THE NAMING SCREEN

The naming method is identical for the various naming situations that appear when you save sounds, projects et cetera.



The [LEFT] and [RIGHT] arrow keys are used to navigate between the characters. Turning the *LEVEL/DATA* knob or pressing the [UP] or [DOWN] arrow keys selects the characters. [FUNC] + [NO] erases letters. [FUNC] + [YES] inserts space.

### 6.5.1 NAMING POP-UP MENU

A convenient way of naming is to open a pop-up menu that shows all available letters, symbols, and digits. Press and hold the [FUNC] key when you are on the NAMING screen to access the NAMING POP-UP menu.



Keep [FUNC] pressed and use the [ARROW] keys to highlight the character you want to insert. Once there, release [FUNC] to add the character.



Copy, paste, and clear commands are available on the NAMING screen.

## 6.6 OVERBRIDGE

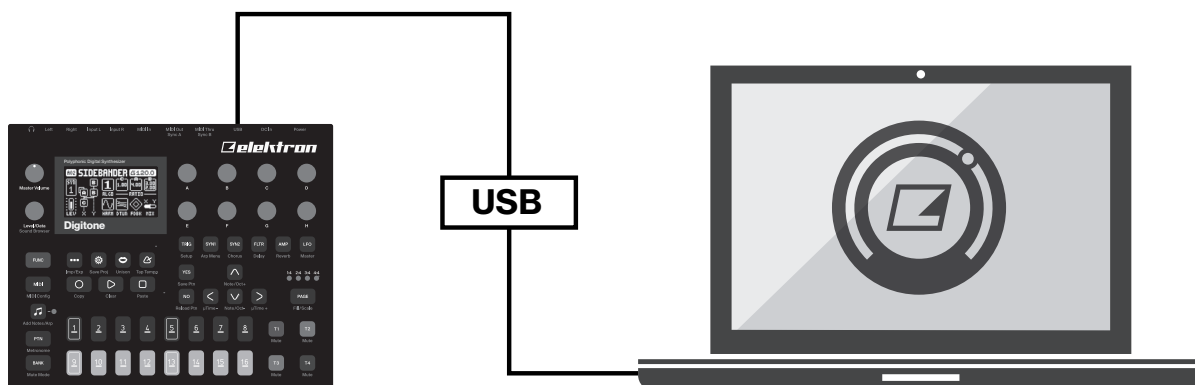

The Overbridge software suite enables a tight integration between the Digitone and a computer DAW software.

When using Overbridge, the user interface for the Digitone presents itself as a plug-in window in your DAW. Access, edit and automate parameters for sound shaping on screen. Always find your device preset parameters in the same state as you left them when you return to your DAW project, with the useful total recall functionality.

Read more about Overbridge use and availability on the Elektron website: <https://www.elektron.se/overbridge/>

## 7. QUICK START

This quick start guides you through some of the basic operations to start using the Digitone right away. First, connect it as described in section “3.3 SETTING UP AND STARTING THE DIGITONE” on page 12.

### 7.1 PLAYING THE FACTORY PRESET PATTERNS

You can find a number of preset patterns, sounds, and samples in the Digitone. Follow the instructions below to get started exploring your new instrument.

1. Press **[BANK]** and then press **[TRIG 9]** key to select bank A. The screen reads “BANK A : SELECT PTN”.
2. Press **[TRIG 1]** key to select the first pattern of bank A.
3. Press **[PLAY]** to listen to pattern A01.
4. Press **[PTN]** and then press **[TRIG 2]** key to select pattern A02. It starts once pattern A01 has reached its end. Select pattern A03 by pressing **[PTN]** and then press **[TRIG 3]** key, and so on.
5. Press **[STOP]** to stop playback.

### 7.2 USING THE TRIG KEYS TO PLAY THE DIGITONE

You can use the **[TRIG]** keys to play any synth track Sound manually.

1. Make sure you are not in GRID RECORDING mode, or MUTE mode.
2. Press **[TRACK 1–4]** keys to select the synth track you wish to play manually. The **[TRIG]** keys are lit up in a pattern that resembles an octave of a piano keyboard layout. Only lit keys are playable.
3. Play the **[TRIG]** keys. The active track Sound is pitched differently for each of the playable keys. Press the **[ARROW]** keys **[UP]** or **[DOWN]**, to transpose the virtual keyboard up or down one octave.

For more information, please see “8.5.1 CHROMATIC MODE” on page 21.

### 7.3 CHANGING SOUNDS

Each of the four synth tracks contains one Sound. You can use the SOUND BROWSER to preview and load Sounds to the synth tracks.

1. Double-press **[TRACK 1–4]** key to open the SOUND BROWSER. You can also press **[FUNC] + TRACK LEVEL** to access the SOUND BROWSER
2. The SOUND BROWSER shows a list of all Sounds residing in either the +Drive Sound library or the Sound pool. (You can press **[BANK] + [TRIG 9–16]** if you want to load a Sound from another Sound bank in the +Drive Sound library). Turn the **TRACK LEVEL** knob or press **[UP]/[DOWN]** to scroll through the list. You can preview a Sound by highlighting it in the list and use the **[TRIG]** keys to play the Sound chromatically. Press **[TRACK NOTE] + [UP]/[DOWN]** to change octave up and down on the Sound you preview.
3. Press **[YES]** to load the highlighted Sound.

### 7.4 USING MUTE MODE

You can mute any of the sequencer tracks in this mode. You can access all tracks simultaneously.

1. Make sure a pattern is playing.
2. Press the **[FUNC] + [BANK]** key to enter MUTE mode.
3. Press any of the **[TRACK]** keys to mute the corresponding track. Press again to unmute. The light of the **[TRACK]** keys indicates the mute status. Unlit keys are muted tracks. Lit keys are active tracks.

For more information, please see “8.5.2 MUTE MODE” on page 21.

### 7.5 TEMPO

Press the **[TEMPO]** key to open the TEMPO menu where you can change the BPM setting. Use the **LEVEL/DATA** knob to change tempo. Pressing the knob while turning it changes the tempo four BPM at a time. The **[ARROW]** keys **[UP]** or **[DOWN]** change the tempo in fractional steps. Note that you can choose between a global tempo or use a separate tempo for every pattern. Press **[FUNC] + [YES]** to switch between GLOBAL and PATTERN tempo mode. On the main interface screen, you can also press and hold the **[ARROW]** keys **[LEFT]** or **[RIGHT]** to nudge the tempo 10% up or down temporarily. Release the key to revert to the original tempo.

To tap a tempo setting, press and hold the **[FUNCTION]** key and tap the **[TEMPO]** key in a steady rhythm. The average tempo of the taps calculates after four consecutive taps. By continuing tapping, the average tempo keeps on updating.



Nudging the tempo is very handy when manually syncing Digitone to a turntable or an external sound source. Note that you do not need to be in the TEMPO menu to perform tempo nudging.

### 7.6 EDITING PARAMETERS

Each track has six PARAMETER pages. Press **[PARAMETER]** keys TRIG, SYN1, SYN2, FLTR, AMP, and LFO to access the different PARAMETER pages. These parameters affect the sound and signal in various ways.

1. Make sure a pattern is playing.
2. Press **[TRACK 1–4]** to select one of the four synth tracks.
3. To change, for example, the cutoff of the filter, press the **[FLTR]** key to open the FILTER page. The parameter labeled **FREQ** changes the cutoff of the filter. Turn **DATA ENTRY** knob **E** to change the parameter value, and hear how the sound is affected.

Try out the rest of the PARAMETER page parameters to explore a variety of sound shaping possibilities.



After you edited the parameters of a Sound, you can save it to the +Drive. For more information, please see “9.4 SAVING A SOUND” on page 24.

## 8. DIGITONE CONTROLS

### 8.1 TRIG KEYS

The [TRIG] keys have several uses, including, playing the active synth track sound chromatically (not in GRID RECORDING or MUTE mode). The [TRIG] keys also place trigs in GRID RECORDING mode. When pressed in combination with the [PTN] and [BANK] keys, they select patterns and banks. The [TRIG] keys light up to indicate the position of placed trigs and to indicate the selected bank and pattern.

### 8.2 ROTARY ENCODERS

The *MASTER VOLUME* is an absolute potentiometer. The *LEVEL/DATA* and *DATA ENTRY* knobs (with which you set various parameter values) are relative encoders which may spin any number of turns. Pressing and turning these encoders changes their associated values at a higher speed.

### 8.3 KEY BEHAVIOR

As a group, the [TRACK] keys have radio button functionality, i.e., when a new track is set to be active, the previous one is simultaneously deactivated. You can only select one track at a time. Likewise, the group consisting of the six [PARAMETER] keys have radio button functionality.

The [FUNC], [PTN], and [BANK] keys are always used in combination with other keys.

### 8.4 MIDI NOTES

Sending MIDI note values from an external MIDI device (a MIDI keyboard or a computer, for example) connected to the Digitone via a standard MIDI cable or a USB 2.0 A to B connector cable can trigger some of the Digitones functions.

MIDI note numbers 0–127 (corresponding to notes C0–G10, the first through to eleventh octaves in the MIDI range) triggers the Sound of the active track.

MIDI program change messages 0–127 will select pattern 1–128 (A01–H16) on the Digitone. Additionally, MIDI CC and NRPN messages can be sent to control various aspects of the Digitone. For more information, please see “APPENDIX B: MIDI IMPLEMENTATION” on page 79.

### 8.5 MODES

#### 8.5.1 CHROMATIC MODE

The chromatic mode is the default mode of the Digitone and is always active unless you are in GRID RECORDING or MUTE mode. In this mode, you can play the sound of the active synth track (or send MIDI notes if you have an active MIDI track) chromatically. In CHROMATIC mode the [TRIG] keys light up in a pattern that resembles an octave of a piano keyboard layout. Only lit keys are playable. Press one of the [TRACK 1–4] keys to select the track you wish to play chromatically.

Press the trig keys to change the chromatic note pitch of the sound. The range from [TRIG 9] key to [TRIG 16] key is one octave. The whole range for both synth tracks and MIDI tracks spans eleven octaves. Press the [ARROW] keys [UP] or [DOWN], to transpose the virtual keyboard up or down one octave.

Notes triggered chromatically can be recorded on the sequencer in LIVE RECORDING mode. Find out how this is done in section “10.2.5 LIVE RECORDING MODE” on page 29.

The active state of CHROMATIC mode (the portion of the chromatic keyboard currently visible on the [TRIG] keys) is not stored per pattern but stays in the state as it was last set.



You can also use an external keyboard or controller to play the active tracks sound chromatically. Connect the keyboard to the Digitone and configure the external keyboard and the Digitone MIDI AUTO Channel (GLOBAL SETTINGS > MIDI CONFIG > CHANNELS) to the same MIDI channel. Then play the keys on the external keyboard to play the active tracks sound chromatically. In this way you can play the active track’s sound chromatically even if the Digitone is not in CHROMATIC mode.

#### 8.5.2 MUTE MODE

You can use MUTE mode to mute any of the 8 sequencer tracks. Unlike CHROMATIC mode, it makes no difference which track is active when you enter MUTE mode. All tracks are accessed simultaneously. Press any of the [TRACK] keys to mute the corresponding track. Press again to unmute. The color of the [TRACK] keys indicates its tracks mute status. Unlit keys signify muted tracks. Lit keys signify un-muted tracks.

There are two different versions of MUTE mode on the Digitone:

- **GLOBAL MUTE MODE** In GLOBAL MUTE mode, the muted tracks are muted in all patterns, and the [TRACK] keys are lit red. If tracks are muted in GLOBAL MUTE mode, the tracks keys are lit red when the pattern plays.

Press [FUNC] + [BANK] to enter GLOBAL MUTE mode.

Press [FUNC] + [BANK] to exit GLOBAL MUTE mode.

- **PATTERN MUTE MODE** In PATTERN MUTE mode, the muted tracks are muted only in the active pattern, and the [TRACK] keys are lit magenta. If tracks are muted in PATTERN MUTE mode, the tracks keys are lit magenta when the pattern plays.

Press [FUNC] + double-tap [BANK] to enter PATTERN MUTE mode.

Press [FUNC] + [BANK] to exit PATTERN MUTE mode.

The GLOBAL MUTE mode settings are saved together with the project. The PATTERN MUTE mode settings are saved together with the pattern.

Tracks that are muted in both GLOBAL MUTE mode and PATTERN MUTE mode are shown with blue lit [TRACK] keys.



- You can also use **QUICK GLOBAL MUTE** to mute and unmute sequencer tracks globally. Press and hold [FUNC] and then press the [TRACK] keys to mute or unmute tracks.
- You can also use **QUICK PATTERN MUTE** to mute and unmute sequencer tracks in the active pattern. Press and hold [PTN] and then press the [TRACK] keys to mute or unmute tracks.
- Digitone remembers the last used version of MUTE mode and accesses this version first when you press [FUNC] + [BANK].

## 9. PATTERNS AND SOUNDS

The patterns are the primary data container for the Digitone. Sixteen patterns are available for each of the eight banks, which means that 128 patterns are available for each project. A pattern contains up to four sounds (one for each synth track), sequencer data like trigs and parameter locks. It also contains the default settings on the TRIG page and BPM, length, swing and time signature settings. A pattern also contains all the parameter settings for the four MIDI tracks.

Each of the synth tracks can contain one Sound. A Sound that is imported from the +Drive or Sound pool to a pattern becomes part of the active pattern. Any changes made to a Sound will therefore not affect the stored Sound. It only affects the Sound in the active pattern. You can export (and in that way save) a Sound from the active pattern to the +Drive. For more information, please see “14.2.2 SOUND MANAGER” on page 59. Use the SOUND BROWSER to load a Sound to a track. For more information, please see “14.2.1 SOUND BROWSER” on page 58.



**When you import a sound to a pattern, it becomes a copy of the Sound on the +Drive. The Sound is not linked to the original Sound stored on the +Drive. Instead, it fully becomes a part of the pattern.**

### A Pattern contains:

- Four synth track Sounds.
- All parameter settings for the four MIDI tracks.
- Sequencer data like trigs and parameter locks.
- The settings on the TRIG PARAMETERS page, BPM, length, swing and time signature settings.

### A Sound contains:

- The SYN1, SYN2, FLTR, AMP, and LFO PARAMETER pages settings for the synth track.
- All the settings in the SOUND SETUP menu and the ARPEGGIATOR menu.

## 9.1 THE +DRIVE SOUND LIBRARY AND THE SOUND POOL

Sounds can be loaded to a pattern from either the +Drive Sound library or the Sound pool of the active project. The difference between the two is that the +Drive Sound library has the capacity of 2048 Sounds, available to all projects, while a Sound pool is a part of a project and limited to 128 Sounds. The primary benefit of Sounds loaded to the Sound pool is the possibility for them to be Sound locked. This feature is not available for the Sounds in the +Drive Sound library. For more information, please see “10.10.2 SOUND LOCKS” on page 35.

### 9.1.1 ADDING SOUNDS TO THE SOUND POOL

You must first add Sounds to the Sound pool to be able to perform Sound locks.

1. Press **[FUNC] + [PATTERN MENU]** to open the IMPORT/EXPORT menu.
2. Select **MANAGE SOUNDS**, and then press **[YES]** to open the SOUND MANAGER.
3. Select the Sounds you want to add to the Sound pool by highlighting them and pressing **[YES]**.
4. Press **[RIGHT]** to open the SOUND OPERATIONS menu.
5. Select **COPY TO ...** and then press **[YES]**.
6. Select **SOUND POOL**, and then press **[YES]**.

## 9.2 PLAYING A SOUND

Press the **[TRIG]** keys to play the Sounds of the four synth tracks of the active pattern. The **[TRIG]** keys briefly lights up when pressed.

### PLAYING A SOUND WITH AN EXTERNAL MIDI UNIT

The Sounds can also be played using an external MIDI device connected to Digitone. The MIDI channels for of each of the synth tracks can be assigned in the MIDI CHANNELS menu, covered in the section “14.3.3 CHANNELS” on page 62. You can also use an external MIDI unit to play the Sound chromatically. For more information, please see “8.5.1 CHROMATIC MODE” on page 21.

## 9.3 EDITING A SOUND

Press **[TRACK 1–4]** to select the track which Sound you wish to edit. Any changes made to a Sound are stored as part of the active pattern.

Adjust the TRACK LEVEL of the active synth track with the *LEVEL/DATA* knob.

Edit a Sound by adjusting the parameters found on the PARAMETER pages. Press the [PARAMETER] page keys to access the PARAMETER pages. Use the *DATA ENTRY* knobs *A-H* to change the parameters. For more information, please see “11. SYNTH TRACK PARAMETERS” on page 39.

If you want to export (save) a particular Sound with all its current parameter settings, use the SOUND MANAGER. For more information, please see “14.2.2 SOUND MANAGER” on page 59.

The complete Sound, with all its parameter settings, may be copied to another track. Press [TRK 1-4] + [RECORD], and then press [TRK 1-4] + [STOP] to paste the sound to the selected track.

### 9.4 SAVING A SOUND

After you edited the parameters of a Sound, you can save it either to the +Drive or to the Sound pool. For more information, please see “9.1 THE +DRIVE SOUND LIBRARY AND THE SOUND POOL” on page 23.

#### 9.4.1 SAVING A SOUND TO THE +DRIVE

A Sound that you save to the +Drive is available for any project.

1. Press [FUNC] + [PATTERN MENU] to open the IMPORT/EXPORT menu.
2. Select EXPORT SOUND, and then press [YES].
3. Turn the *LEVEL/DATA* knob or use the [UP]/[DOWN] keys to select an empty slot to where you want to save your Sound, and then press [YES]. If you want to save your Sound to another bank, press [BANK] + [TRIG 9-16] to select a bank.
4. On the NAMING screen, name your Sound and then press [YES]. For more information, please see “6.5 THE NAMING SCREEN” on page 17.
5. On the TAGS screen, use the [ARROW] keys and [YES] key to select the appropriate tags for your sound, and then select <SAVE> and press [YES].

#### 9.4.2 SAVING A SOUND TO THE SOUND POOL

A Sound that you save to the Sound Pool is only available for the current project, but it can be Sound locked.

1. Press [FUNC] + [PATTERN MENU] to open the IMPORT/EXPORT menu.
2. Select MANAGE SOUNDS, and then press [YES] to open the SOUND MANAGER.
3. Press [LEFT] to open the SORTING menu and select VIEW POOL, and then press [YES].
4. Turn the *LEVEL/DATA* knob or use the [UP]/[DOWN] keys to select an empty slot to where you want to save your Sound.
5. Press [RIGHT] to open the SOUND OPERATIONS menu.
6. Select EXPORT TO HERE and then press [YES].
7. On the NAMING screen, name your Sound and then press [YES]. For more information, please see “6.5 THE NAMING SCREEN” on page 17.

### 9.5 SOUND SETUP MENU

Press [FUNC] + [TRIG PARAMETERS] to open the SOUND SETUP menu. Here you can set a number of Sound related parameters. Use the [UP] and [DOWN] arrow keys to move between the options. Press [YES] to confirm your selection. Press [NO] to exit the menu.

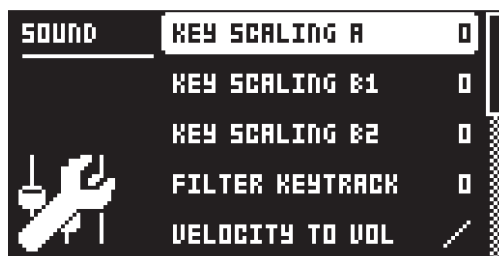

#### 9.5.1 KEY SCALING A

Key scaling sets the level of how much the modulation output from operator A is affected by what note you play on the keyboard. If you set key scaling to 0, the modulation level is the same for all keys. A higher setting decreases the modulation level more and more the higher you play the keyboard. A lower level



of modulation decreases the complexity of the tone in the higher frequencies, which is a typical behavior in many acoustic instruments.

### 9.5.2 KEY SCALING B1

Same as **KEY SCALING A**, but for operator B1

### 9.5.3 KEY SCALING B2

Same as **KEY SCALING A**, but for operator B2

### 9.5.4 FILTER KEYTRACK

Keytrack lets the Multimode filter cutoff frequency follow the pitch of the Sound. A setting of 100 makes the filter track the oscillator frequency in note intervals. (0–100)

### 9.5.5 VELOCITY TO VOL

Selects how MIDI velocity affects volume when playing the Sound from a MIDI keyboard.

OFF means velocity does not affect the volume of the Sound.

LOG applies a logarithmic velocity curve. The volume difference are greater between softer keyboard presses than between harder.

LIN applies a linear velocity curve. The volume difference between keyboard presses corresponds linearly to the force applied.

EXP applies an exponential velocity curve. The volume difference are greater between harder keyboard presses than between softer.

### 9.5.6 PITCH BEND DEPTH

Sets how much the pitch bend data from external MIDI devices affects the Digitone.

### 9.5.7 OCTAVE

Sets the base octave of the Sound. This setting makes it easier to play the sound at the “right” octave on the Digitone keyboard. It also makes Sound locking more practical since you can control the octave setting on the Sound and minimize the need to transpose the sequencer notes to make two or more Sounds work together.

### 9.5.8 PITCH BEND

Opens a menu where you can assign up to four **PARAMETER** page parameters to the pitch bend. The pitch bend from incoming MIDI sent to the Digitone from external devices affects the assigned parameters. Press **[YES]** to open the menu.

You can select parameters from the **SYN1**, **SYN2**, **FLTR**, **AMP**, and **LFO PARAMETER** pages. Turn the **DATA ENTRY** knobs **A–D** to select the track parameters that you wish to assign. Press **[YES]** to confirm the selection. Then use **DATA ENTRY** knobs **E–H** to set the modulation depth of the four track parameters. The depth is an offset of the original track parameter value.

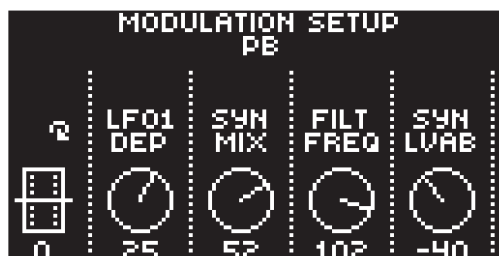

### 9.5.9 VELOCITY MOD

Opens a menu where you can assign up to four **PARAMETER** page parameters to the velocity parameter. Both the **VEL** parameter on the **TRIG** menu and the velocity of incoming MIDI notes sent to the Digitone from external devices affects the assigned parameters. Press **[YES]** to open the menu. Setting up the parameters works in the same way as for **PITCH BEND**.

### 9.5.10 MOD WHEEL

Opens a menu where you can assign up to four **PARAMETER** page parameters to the MIDI mod wheel command (CC #1). Press **[YES]** to open the menu. Setting up the parameters works in the same way as for **PITCH BEND**.

**9.5.11 BREATH CONTROLLER**

Opens a menu where you can assign up to four PARAMETER page parameters to the MIDI breath controller command (CC #2). Press [YES] to open the menu. Setting up the parameters works in the same way as for PITCH BEND.

**9.5.12 AFTERTOUCH**

Opens a menu where you can assign up to four PARAMETER page parameters to the MIDI aftertouch command. Press [YES] to open the menu. Setting up the parameters works in the same way as for PITCH BEND.

**9.6 ARPEGGIATOR MENU**

The ARPEGGIATOR menu controls the Sounds arpeggiator. The arpeggiator settings are part of the Sound and saved together with the Sound. The arpeggiator is not available for the MIDI tracks. Press [FUNC] + [SYN1] to open the ARPEGGIATOR menu. Press [TRACK 1-4] key to select the Sound whose arpeggiator are edited. Press [FUNC] + [TRACK NOTE] to toggle the ARPEGGIATOR on and off.

**9.6.1 MODE**

Activates the arpeggiator and controls how the arpeggiated notes are sorted.

OFF deactivates the arpeggiator.

TRUE plays the notes in the same order as they are inserted.

UP plays the notes in ascending order, from the lowest note to the highest, on a per octave basis.

DOWN plays the notes in descending order, from the highest note to the lowest, on a per octave basis.

CYCL plays the notes first in ascending order, then in descending order.

**9.6.2 SPD**

Speed sets the speed of the arpeggiator. It is synchronized to the BPM of the project. (1/1-1/96).

**9.6.3 RNG**

Range sets the octave range of the arpeggiator. After each completed arpeggiator cycle, the arpeggiated notes are transposed one octave up. When the notes have reached the octave offset specified by the RNG setting the notes are reset to their initial values. From there the octave transpose is started all over again.

**9.6.4 LEN**

Length controls the length of the arpeggiated notes.

**9.6.5 ARP LENGTH**

Turn *DATA ENTRY* knob *F* to select the length of the arpeggio. The max length is 16 sequencer steps.

**9.6.6 OFFSET**

Offset selects the offset (note) value of the chosen arpeggiator step in semi-tones. The offset is from the original note trig. The TRK KEY SCALE and TRK KEY NOTE settings found in the NOTES SETUP menu affects the note values of the arpeggiated notes.

1. Press [LEFT] or [RIGHT] to select which arpeggiator step to offset.
2. Use *DATA ENTRY* knob *E* to set the offset.
3. Press [DOWN] to deactivate an arpeggiator step. Press [UP] to activate an arpeggiator step that has been deactivated.

## 10. THE SEQUENCER

The sequencer store its information in patterns. A pattern controls the playback of the synth tracks, the MIDI tracks and various pattern-specific aspects of the tracks. Each of the eight banks, A to H, contains 16 patterns, which means 128 patterns are available for each project. For more information, please see “10.7 PATTERN MENU” on page 32.

**A pattern contains:**

- The parameter settings on the TRIG page (root note, velocity, length et cetera).
- The parameter settings on the SYN1, SYN2, FLTR, AMP, and LFO pages.
- The parameter settings on the CHORUS, DELAY, REVERB, and MASTER pages.
- Quantization settings.
- Note trigs for all tracks.
- Lock trigs for all tracks.
- Sound locks
- Parameter locks.
- Length and time signature for the tracks.

### 10.1 BASIC PATTERN OPERATIONS

Digitone can seamlessly switch between patterns. Together with the ability to chain patterns, this is a handy feature when improvising live. For more information, please see “10.11 CHAINS” on page 37.

#### 10.1.1 SELECTING BANK AND PATTERN

Press **[BANK]** and then press **[TRIG 9–16]** to select a bank. Then press **[TRIG 1–16]** to select a pattern. Press **[PTN]** and then press **[TRIG 1–16]** to select a new pattern in the current bank. When you press **[BANK]** or **[PTN]** you must choose a bank or pattern within four seconds for the change to take effect. A message on the screen indicates the four-second timeout. Press **[PTN]**, **[BANK]**, or **[NO]** to exit pattern or bank select.

White **[TRIG]** keys indicate pattern positions that contain data. A red **[TRIG]** key indicates the current active pattern. Empty patterns **[TRIG]** keys are unlit.

When a pattern is playing, and a new pattern is selected, the new pattern position is shown flashing in the upper left corner of the screen. Once the last step of the pattern has played, the new pattern starts, and the pattern position ceases to flash.



- Patterns can be changed while the sequencer is running.
- Patterns can be changed and queued by sending program change messages.

#### 10.1.2 PATTERN CONTROL

Press **[PLAY]** to start the pattern playback. Press **[STOP]** to stop the playback. When a pattern plays, press **[PLAY]** to pause. When a pattern is paused, press **[PLAY]** to resume the playback. The audio is cut off, but effects like the delay continues until the delay repeats fades out. Quickly press **[STOP]** twice to stop playback of all tracks and the fade out of the send effects.

The <PATTERN PAGE> LEDs indicates If a pattern contains more than 16 sequencer steps. A flashing <PATTERN PAGE> LED indicates the currently active pattern page when a pattern is playing.

#### 10.1.3 PATTERN TEMPO

You set the tempo in the TEMPO menu. Press **[TEMPO]**  to open this menu. For more information, please see “7.5 TEMPO” on page 19.

## 10.2 CREATING AND EDITING A PATTERN

Digitone has two main modes of input when you want to create or edit a pattern, GRID RECORDING mode and LIVE RECORDING mode.

### 10.2.1 TRIG TYPES

A trig is a sequencer event that you can place where you want the sequencer to perform an action on the Digitone. There are two types of trigs available in both recording modes: Note trigs and Lock trigs.

- **Note trigs** trigger notes on synth tracks and MIDI tracks.
- **Lock trigs** trigger parameter locks, but without triggering notes.

Red [TRIG] keys indicates note trigs and yellow [TRIG] keys indicates lock trigs. Unlit [TRIG] keys indicate steps that do not contain any trigs. Read more about parameter locks in section “10.10.1 PARAMETER LOCKS” on page 34. The two types of trigs are added differently in the sequencer, depending on whether GRID RECORDING or LIVE RECORDING mode is active.

### 10.2.2 GRID RECORDING MODE

GRID RECORDING is a method of composing where you use the [TRIG] keys to add trigs.

1. Press [TRACK 1–4] to select the track to which you want to add trigs. A green [TRACK] key light indicates the active track.
2. Press [RECORD] to enter GRID RECORDING mode. The [RECORD] key lights up red to indicate that GRID RECORDING mode is active.
3. Use the [TRIG] keys to place note trigs on the sequencer. The trigs note value is the value specified by the **ROOT** parameter in the TRIG PARAMETERS page. For more information, please see “11.2.1 ROOT” on page 39.  
To add a lock trig, press [FUNCTION] and [TRIG]. You can enter lock trigs on any sequencer step, including ones that contain note trigs.  
Press the [TRIG] key of any of the previously entered trigs if you wish to remove the trig. Press a [TRIG] key of a trig and hold it slightly longer to prepare the trig for editing, rather than removing it.
4. Select another track, and add note trigs and lock trigs. Repeat the procedure for all the tracks you want to use.
5. Press [PLAY] to listen to the sequence.



- Add micro timing to a note trig by pressing and holding the [TRIG] key and then press the [LEFT]/[RIGHT] keys. For more information, please see “10.6 MICRO TIMING MENU” on page 31..
- If the pattern contains more than 16 steps, select the pattern page you want to edit by pressing the [PAGE] key. A fully lit <PATTERN PAGE> LED shows the active pattern page.
- All trigs of a track can be shifted forwards or backward on the sequencer. While in GRID RECORDING mode, hold down [FUNC] while pressing the [LEFT] or [RIGHT] arrow keys to perform the trig shift.

### 10.2.3 GRID RECORDING USING TRACK NOTE METHOD

This is an alternative way to enter note trigs in GRID RECORDING mode that gives you more control over what note values you want to add to a specific step in the sequencer.



1. Press [TRACK 1–4] to select the track to which you want to add note trigs and additional notes. A green [TRACK] key light indicates the active track.
2. Press [RECORD] to enter GRID RECORDING mode. The [RECORD] key lights up red to indicate that GRID RECORDING mode is active.
3. Press the [TRIG] key to where you want to add or remove notes + [TRACK NOTE] . A graphic keyboard appears on the screen where you can see all the notes on the chosen sequencer step. A key with a dot on the screen keyboard indicates added notes.
4. Press the [TRIG] keys to add notes with the corresponding note value. Press the [TRIG] key of a previously entered note if you wish to remove that note.
5. Press [YES] to enter the changes and then exit. Press [NO] if you wish to exit without making any changes.

### 10.2.4 GRID RECORDING USING QUICK NOTE METHOD

This is yet another alternative way to enter note trigs in GRID RECORDING mode that gives you better control over what note values you want to add to a specific step in the sequencer.



1. Press **[TRACK 1–4]** to select the track to which you want to add note trigs and additional notes. A green **[TRACK]** key light indicates the active track.
2. Press **[RECORD]** to enter GRID RECORDING mode. The **[RECORD]** key lights up red to indicate that GRID RECORDING mode is active.
3. Press and hold (keep holding until step 8 of this procedure) the **[TRIG]** key to where you want to add, adjust or remove notes and then press **[UP]** or **[DOWN]**. A graphic mini keyboard appears at the top the screen. The leftmost number is the active note. The number in brackets shows the number of notes on the sequencer step. Then follows the note value of the active note. A filled key on the screen keyboard shows the active note and the other notes are shown as dots.
4. Use the **[UP]** and **[DOWN]** keys to adjust the value of the note. Press and hold **[FUNCTION]** and press **[UP]** or **[DOWN]** key to adjust the pitch one full octave up or down.
5. Press **[YES]** to add a new note. Then use the **[UP]** and **[DOWN]** keys to move the added note to the desired note value.
6. Use the **[LEFT]** and **[RIGHT]** keys to navigate to a previously added note and then press **[UP]** or **[DOWN]** to move the note. Note 1 is the root note. The other notes are offsets to the root note. If you adjust the root note value, the other notes moves along with it.
7. Press **[NO]** if you wish to remove an already added note.
8. Release the **[TRIG]** key to execute the Quick Note edit and then exit.

### 10.2.5 LIVE RECORDING MODE

LIVE RECORDING mode is the second method of adding trigs to the tracks. In this recording mode, the **[TRIG]** keys are played in real time to input trigs to the tracks. You can also turn the **DATA ENTRY** knobs to enter parameter locks in real time. Trigs input in LIVE RECORDING mode can be automatically quantized or not. Use the settings in the QUANTIZE menu to quantize non-quantized trigs after they are recorded. For more information, please see “10.7.1 QUANTIZE” on page 32.

1. Press **[TRACK 1–4]** to select the track to which you want to add trigs. A green **[TRACK]** key light indicates the active track.
  2. Press and hold **[RECORD]**, then press **[PLAY]** to enter LIVE RECORDING mode. If you quickly press **[PLAY]** twice while keeping the **[RECORD]** key pressed, you activate/deactivate the quantization of LIVE RECORDING. The sequencer starts to play, and the **[RECORD]** key starts to flash red.
  3. Press the **[TRIG]** keys to enter trigs in real time. The **[TRIG]** key pressed determines the pitch value of the note trig. The sequencer also records all changes to the PARAMETER pages settings you make when you turn the **DATA ENTRY** knobs as parameter locks and adds lock trigs accordingly.
  4. Press **[PLAY]** to exit LIVE RECORDING mode while keeping the sequencer playing. GRID RECORDING mode is activated if you press **[RECORD]** while LIVE RECORDING mode is active.
  5. Press **[STOP]** to stop both recording and playback of the sequencer.
- To exit LIVE RECORDING mode while keeping the sequencer playing, press **[PLAY]**.



- You can use an external MIDI controller such as a keyboard, to input NOTE, TRIG VELOCITY, and TRIG LENGTH data in LIVE RECORDING mode. Just play the notes on the keyboard and the sequencer records them. You can add up to a eight-note chord to every trig. The first note sets the TRIG VELOCITY value for all notes on the trig. The last note that is released sets the TRIG LENGTH for all notes on the trig.

If you use an external MIDI controller to record to the Digitone MIDI tracks, the sequencer receives data on the auto MIDI channel and records on the active track. For more information, please see “14.3.3 CHANNELS” on page 62.

### 10.3 TRIG PARAMETERS

Set the actions for what happens when the sequencer trigs a note in the TRIG PARAMETERS page. Press the [TRIG] key to access the menu. Change settings using the **DATA ENTRY** knobs. These general settings affect note trigs placed on the sequencer. On any step of the pattern, you can lock trigs to other settings by first pressing and holding a [TRIG] key, then changing the settings. For more information, please see “11.2 TRIG PARAMETERS PAGE 1” on page 39.

### 10.4 TRACK NOTE MENU

Press [TRACK NOTE]  to open the TRACK NOTE menu. Here you get a graphical view of the Digitone keyboard and see which notes the [TRIG] keys play. Press [UP]/[DOWN] to transpose the keyboard up or down an octave. In this menu, you can also set different musical scales, enable chords, and transpose the tracks. Press [TRACK 1-4] key to select which track to edit. Use the **DATA ENTRY** knobs to change the settings. Press [NO] to exit the menu. The track note settings are stored in the active pattern.



**KB SCALE** sets the tracks scale. This is done by limiting which keys that are playable on the Digitone keyboard and from external MIDI devices that sends on the Digitone’s AUTO channel. (Chromatic, Ionian (Major), Dorian, Phrygian, Lydian, Mixolydian, Aeolian (Minor), Locrian.)

**SCALE KEY** sets the key for the chosen scale.

**KB CHORD** adds a three-note chord based on the **KB SCALE** and **SCALE KEY** settings when you press a key on the Digitone keyboard. (OFF, ON) If you set **KB SCALE** to CHROMATIC you have a selection of different chords to choose from. (MAJ, MIN, 7TH, MIN7, MAJ7, DIM, DIM7)

**TRANSP. TRACK** transposes the track up or down in semitone steps. This parameter adds an offset value and the actual note values in the sequencer do not change. Use **DATA ENTRY** knob **D** to change the setting, and then press [YES] to confirm the setting. You can also use DIRECT TRACK transpose to transpose a track. For more information, please see “10.10.8 DIRECT TRACK TRANSPOSE” on page 37. (-36–+36)



- If you press [TRACK NOTE] when you are in GRID RECORDING mode you exit the GRID RECORDING mode. If you press [RECORD] when you are in the TRACK NOTE menu, you exit the menu and enter GRID RECORDING MODE.
- You can copy the settings in the TRACK NOTE menu and paste it to another track. In the TRACK NOTE menu, press [FUNC] + [RECORD] to copy the parameter settings. Change track and open TRACK NOTE menu, and then press [FUNC] + [STOP] to paste the settings.

### 10.5 VOICE MENU

Press [VOICE]  to open the VOICE menu, where you handle the allocation of the Digitones eight voices. In this menu, you can also make the settings for unison and voice stealing. Press [TRACK 1-4] key to select which track to edit. At the top left of the screen, you can see what track is selected. A dot next to the track number indicates that the sound is in mono. For more information, please see “9.5 SOUND SETUP MENU” on page 24. Use the **DATA ENTRY** knobs to change the settings. Press [NO] to exit the menu. The voice settings are stored in the active pattern.

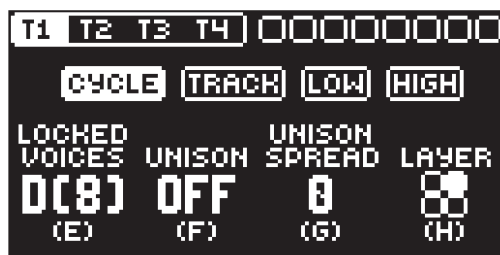

**VOICE STEALING** The Digitone has eight voice polyphony. VOICE STEALING sets the rules for how voices are stolen (which voice is taken when you play a new note) when you use more than eight voices at the same time. Press [LEFT]/[RIGHT] to select voice stealing mode.

**CYCLE** The first played note is stolen first.

**TRACK** Track priority. Notes played on track 1 has priority over notes played on track 2, 3, and 4. Track 2 notes over track 3, 4 Track 3 notes over track 4.

**LOW** Lowest note is stolen first

**HIGH** Highest note is stolen first.

**LOCKED VOICES** Sets the number of voices (1–8) you want to lock to a specific track. A locked voice cannot be used or stolen by another track. If you lock voices to a track, the track cannot use more voices than the ones that are locked to it. The first number shows the number of locked voices to the track. The number in brackets shows how many unlocked voices that remain. If you set the parameter to D (dynamic) it will use any available voices to play its Sound.

**UNISON** Gives the possibility to add several voices to play the same note. The parameter sets the number of voices that plays for each note. If unison is not possible due to locked voices on other tracks, this parameter is greyed out and unavailable.



[FUNC] + [VOICE] toggles unison on/off. [VOICE] blinks if unison is not possible due to locked voices on other tracks.

**UNISON SPREAD** Adds pan and detune to the unison voices.

**LAYER** Makes it possible to trig two or more tracks with the same note from the sequencer or the keyboard. For example, if you on track 1 set **LAYER** to affect track 2 then every note you play on track 1 also plays on track 2, effectively playing two Sounds at the same time. Tracks that are layered to the active track have filled squares in the parameter representation on the screen.



You can copy the settings in the VOICE menu and paste it to another pattern. In the VOICE menu, press [FUNC] + [RECORD] to copy the parameter settings. Change pattern and open VOICE menu, and then press [FUNC] + [STOP] to paste the settings.

## 10.6 MICRO TIMING MENU

Here you can add micro timing to a note trig, moving it ahead or behind the beat. You can customize the micro timing on any of the sequencer steps on both synth and MIDI tracks. In GRID RECORDING mode, press and hold one or several [TRIG] keys and then press [LEFT]/[RIGHT] to access the pop-up Micro timing menu that shows the time offset for the chosen sequencer step(s) on the active track. To exit the micro timing menu, release the [TRIG] key(s). The micro timing settings are stored in the active pattern



**MICRO TIMING** Press [LEFT]/[RIGHT] keys to adjust the time offset.

## 10.7 PATTERN MENU

Use the PATTERN menu to perform pattern management. Press [PATTERN MENU]  to open the menu. Use the [UP] and [DOWN] arrow keys to move between the options. Press [YES] to confirm your selection. Press [NO] to exit the menu.

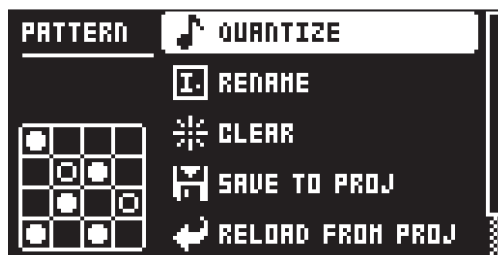

### 10.7.1 QUANTIZE

Affects all micro timed trigs on the sequencers tracks. Change settings with *DATA ENTRY* knob *E* and *F*.

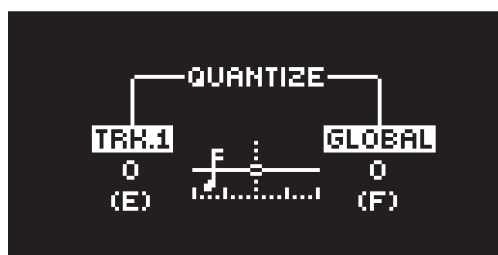

**TRK.** affects all micro-timed trigs of the active track in real time. The higher the quantize value, the more all micro-timed trigs are quantized. Press [TRACK 1-4] key to select what track to quantize. (0-127)

**GLOBAL** affects all micro-timed trigs of all tracks in real time. The higher the quantize value, the more all micro-timed trigs are quantized. (0-127)

Press [FUNC] + [YES] to apply quantization to the pattern. Press [NO] to exit the menu.

### 10.7.2 RENAME

Opens a NAMING screen where you can rename the active pattern.

### 10.7.3 CLEAR

**WHOLE PATTERN** Clears the active pattern's sequencer and Sounds data. A prompt appears when you select this option. Press [YES] to clear, or [NO] to cancel the operation. Note that you do not lose any pattern information permanently until you save the pattern to the same pattern slot.

**SOUNDS DATA** Clears the active patterns four Sounds. All sequencer data will remain unchanged. A prompt appears when you select this option. Press [YES] to clear, or [NO] to cancel the operation. Note that until you save the pattern to the same pattern slot that you loaded from, you do not lose any Sound information permanently.

**SEQUENCE DATA** Clears the active pattern's sequence data. All sounds remain unchanged. A prompt appears when you select this option. Press [YES] to clear, or [NO] to cancel the operation. Note that until you save the pattern to the same pattern slot that you loaded from, you do not lose any sequencer information permanently.

### 10.7.4 SAVE TO PROJ

You must have saved the project at least once before you can save pattern information.

**WHOLE PATTERN** Saves the active pattern's sequence data and four Sounds to the +Drive. A prompt appears when you select this option. Press [YES] to save, or [NO] to cancel the operation.

**SOUNDS DATA** Saves the active pattern's four Sounds to the +Drive. A prompt appears when you select this option. Press [YES] to save, or [NO] to cancel the operation.

**SEQUENCE DATA** Saves the active pattern's sequence data to the +Drive. A prompt appears when you select this option. Press [YES] to save, or [NO] to cancel the operation.

For more information, please see "10.10.7 TEMPORARY SAVE AND RELOAD PATTERN COMMANDS" on page 37.



### 10.7.5 RELOAD FROM PROJ

You must have saved the pattern at least once before you can reload pattern information.

**WHOLE PATTERN** Reloads the active pattern's sequence data and four Sounds from the +Drive. A prompt appears when you select this option. Press **[YES]** to reload, or **[NO]** to cancel the operation.

**SOUNDS DATA** Reloads the active pattern's four Sounds from the +Drive. A prompt appears when you select this option. Press **[YES]** to reload, or **[NO]** to cancel the operation.

**SEQUENCE DATA** Reloads the active patterns all sequence data from the +Drive. A prompt appears when you select this option. Press **[YES]** to reload, or **[NO]** to cancel the operation.

### 10.7.6 IMPORT/EXPORT

Here you can manage the sounds on the Digitone. You can also press **[FUNC] + [PATTERN MENU]** to access this menu directly.

**IMPORT SOUND** Imports (copies) a Sound from the +Drive to the active pattern. Turn the **LEVEL/DATA** knob or press **[UP]/[DOWN]** to scroll through the list. Press **[YES]** to select a Sound and then press **[TRACK 1-4]** to select the track to where you want to assign the sound.

**EXPORT SOUND** Exports (saves) the active track's Sound to the +Drive. Turn the **LEVEL/DATA** knob or press **[UP]/[DOWN]** to choose a destination memory slot. Press **[YES]** to export the sound. Name the Sound and press **[YES]** again to confirm the export.

**MANAGE SOUNDS** Opens the SOUND MANAGER. For more information, please see "14.2.2 SOUND MANAGER" on page 59.

## 10.8 METRONOME MENU

The METRONOME menu controls the internal metronome of the Digitone. Press **[FUNCTION] + [PTN]** to open the METRONOME menu. Use the **DATA ENTRY** knobs to change the settings.

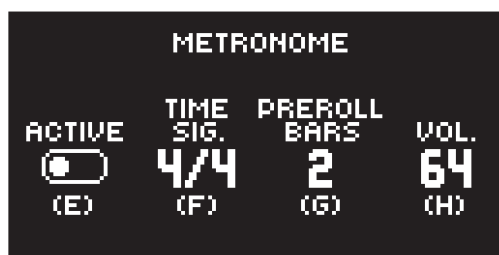

**ACTIVE** activates/deactivates the metronome. You can also press **[FUNC] + [PTN]** and hold for a second to toggle the metronome on and off when you are not in the METRONOME menu.

**TIME SIG.** controls the note and beat measure of the metronome time signature.

**PREROLL BARS** controls for how many bars the metronome sounds before the sequencer starts playing. This setting is only relevant when you are in LIVE RECORDING mode.

**VOL.** controls the volume of the click.

## 10.9 SCALE MENU

You can set the length and timing of the pattern and tracks in this menu. The SCALE menu has two modes. In LENGTH PER PATTERN mode all tracks share the same length. In LENGTH PER TRACK mode, each track can have different lengths. Press **[FUNC] + [PAGE]** to access the SCALE menu. Press **[FUNC] + [YES]** to toggle between the two SCALE modes. Use the **DATA ENTRY** knobs to adjust the settings.

### 10.9.1 LENGTH PER PATTERN MODE

In this mode, all tracks of the pattern share the same length and time signature.



**LENGTH** controls the step length of the pattern. The leftmost number displays the number of steps in the pattern. The total length, displayed by the second number, determines the maximum number of steps available in the pattern. This setting can be either 16, 32, 48 or 64 steps. If you use 17 steps or more in a pattern, the **[PAGE]** key is (while in GRID RECORDING mode) used to toggle between the different pattern pages.

**SCALE** controls the time signature of the pattern. It offers seven possible settings, 1/8X, 1/4X, 1/2X, 3/4X, 1X, 3/2X and 2X. A setting of 1/8X plays back the pattern at one-eighth of the set tempo. 3/4X plays the pattern back at three-quarters of the tempo; 3/2X plays back the pattern twice as fast as the 3/4X setting. 2X makes the pattern play at twice the BPM.

When you extend the length of a pattern, its trigs copies automatically over to the new steps. If a pattern consists of for example two pages and the pattern length is increased to four pages, the two additional pattern pages are then copies of the first two pattern pages.

Press the **[PAGE]** key to change the total length of the pattern quickly. Press the **[TRIG]** keys to change the number of steps of the pattern quickly.

A 2X time signature setting is useful for increasing the base resolution of the step sequencer to 32nd notes. A 3/4X setting is useful when Digitone is playing alongside other instruments set to the same BPM, and you want Digitone to play triplets.

### 10.9.2 LENGTH PER TRACK MODE

In this mode, you can assign individual lengths the tracks of the pattern. Press **[FUNC] + [YES]** to switch between the two scale modes. In LENGTH PER TRACK mode, two columns exist, TRACK and PATTERN.

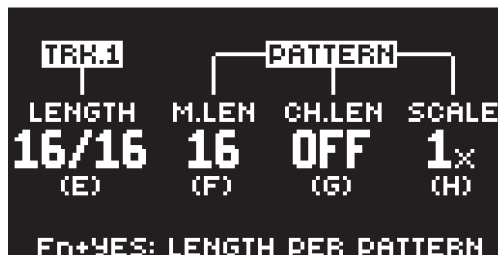

The TRACK column sets the step length of the track. It works just like setting the pattern length in LENGTH PER PATTERN mode. The settings only affects the active track. Press the **[TRK]** keys to select the track whose scale settings you wish to edit.

The PATTERN column sets the master length, the master change length and the general time signature of the pattern.

**M.LEN** controls the number of steps the pattern plays before all tracks restart. An INF setting makes the tracks of the pattern loop infinitely, without ever being restarted. Note that this setting also affects for how long the active pattern plays before a chained pattern starts playing. The **CH.LEN** parameter can override this.

**CH.LEN** controls for how long the active pattern plays before a cued or chained pattern begins to play. This setting is important when, for example, you set **M.LEN** to INF. If you do not make any **CH.LEN** setting, the pattern plays infinitely, and the next pattern is thus not cued. However, if **CH.LEN**, for instance, is set to 64, the pattern behaves like a pattern consisting of 64 steps regarding cueing and chaining.

**SCALE** sets the general time signature of the pattern.

## 10.10 SEQUENCER FEATURES

### 10.10.1 PARAMETER LOCKS

Parameter locks make it possible to set every trig to have its unique parameter values. The note trigs of a synth track can, for example, have different pitch, amp or filter settings. It is possible to parameter lock the parameters found on the PARAMETER pages (SYN1, SYN2, FLTR, AMP, and LFO), and you can apply parameter locks to all types of tracks. For a complete overview of all parameters on the PARAMETER pages, please see "11. SYNTH TRACK PARAMETERS" on page 39, and "12. MIDI TRACK PARAMETERS" on page 49.

To apply parameter locks in GRID RECORDING mode, press **[FUNC] + [TRIG]** to add a lock trig, and then press and hold the **[TRIG]** key of a trig (note trig or a lock trig). Use the **DATA ENTRY** knobs to adjust the parameters you want to lock. The graphics become inverted for the locked parameter, and

the locked parameter values are displayed. The **[TRIG]** key of the locked trig blinks red (for note trigs) or yellow (for lock trigs) to indicate the trig now contains a parameter lock.

Remove a single parameter lock by holding **[TRIG]** + pressing the **DATA ENTRY** knob of the locked parameter. You can erase all parameter locks from a trig if you remove the note trig and then enter it again.

In LIVE RECORDING mode, turn a **DATA ENTRY** knob, or play the **[TRIG]** keys in CHROMATIC mode, to add parameter locks to the active track. Note trigs are placed, and parameter locked accordingly, and it also places lock trigs that contains the parameter locks on the sequencer steps that do not already have any trigs.

Press **[NO]** + one (or several) of the **[TRACK]** keys to erase a sequence of recorded trigs on a specific track (or on several tracks) in time with the sequencer. This procedure erases the trigs on all steps reached by the sequencer on the corresponding tracks.

You can also remove specific parameter locks on a track in real time. In LIVE RECORDING mode, press and hold **[NO]** and then press and hold the **DATA ENTRY** knob corresponding to the parameter that you want to remove.



Up to 72 different parameters can be locked in a pattern. A parameter counts as one (1) locked parameter no matter how many trigs that lock it. If for example the cutoff parameter of the filter is locked on every sequencer step, there are still 71 other parameters that can be locked.

### 10.10.2 SOUND LOCKS

You can change a tracks Sound to another Sound from the Sound pool on any individual sequencer step. These Sound locks are an immensely useful feature for adding variations to a track. Press and hold a note trig and turn the **LEVEL/DATA** knob to open the Sound pool list. Use the **LEVEL/DATA** knob to scroll through the list. Select the Sound you want to assign to the note trig and then release the **[TRIG]** key. The **[TRIG]** key starts to flash to indicate that it contains a Sound lock. Press and hold the **[TRIG]** key of the note trig to show the assigned Sound. For more information, please see “9.1.1 ADDING SOUNDS TO THE SOUND POOL” on page 23.

### 10.10.3 CONDITIONAL LOCKS

On the TRIG PARAMETERS page, there is a parameter called **COND** (Trig Condition) with which a set of conditional rules can be applied to any trig, using a parameter lock. Each setting is a logical condition that determines whether a trig set on a track in the sequencer is triggered or not. If the condition is true, then the trig becomes active and affect the track. If the condition is false, the trig is ignored. You must first place a note trig or lock trig on the sequencer step to where you want to apply a conditional lock.

The sequencer needs to be in FILL mode to activate the conditional lock called FILL. For more information, please see “10.10.4 FILL MODE” on page 36.

You can set the following trig conditions:

**FILL** is true (activates the trig) when FILL mode is active.

$\overline{\text{FILL}}$  is true when FILL is false. A trig with this trig condition is active when you are not in FILL mode.

**PRE** is true if the most recently evaluated trig condition on the same track was true. ( $\overline{\text{PRE}}$  and  $\overline{\overline{\text{PRE}}}$  conditions are ignored and not evaluated.)

$\overline{\text{PRE}}$  is true when PRE is false. A trig with this trig condition is active if the most recently evaluated trig condition on the same track was not true. ( $\text{PRE}$  and  $\overline{\overline{\text{PRE}}}$  conditions are ignored and not evaluated.)

Example 1: Trig 1, 50% = **True** > Trig 2,  $\overline{\text{PRE}}$  = **False** > Trig 3,  $\overline{\overline{\text{PRE}}}$  = **False** > Trig 4, **PRE** = **True**

Example 2: Trig 1, 50% = **False** > Trig 2,  $\overline{\overline{\text{PRE}}}$  = **True** > Trig 3,  $\overline{\text{PRE}}$  = **True** > Trig 4, **PRE** = **False**

**NEI** is true if the most recently evaluated trig condition on the neighbor track was true. ( $\overline{\text{PRE}}$  and  $\overline{\overline{\text{PRE}}}$  conditions on the neighbor track are ignored and not evaluated.) The neighbor track is the track before the active track. For example, track 3 is the neighbor track of track 4. **NEI** and  $\overline{\text{NEI}}$  conditional trigs on track 4 evaluate the conditional trigs placed on track 3. The **NEI** condition is false if no conditional trigs exist on the neighbor track.

$\overline{\text{NEI}}$  is true when **NEI** is false. A trig with this trig condition is active if the most recently evaluated trig condition on the neighbor track was not true. ( $\text{PRE}$  and  $\overline{\overline{\text{PRE}}}$  conditions on the neighbor track are ignored and not evaluated.)

**1ST** is true the first time the pattern plays (when looped).

$\overline{\text{1ST}}$  is true when **1ST** is false. A trig with this trig condition is always active apart from the first time the pattern plays (when looped).

**X%** is a probability condition. There is an X% chance that the trig will be active.

**A:B** **A** sets how many times the pattern plays before the trig condition is true. **B** sets how many times the pattern plays before the count is reset and starts over again. This cycle then repeats indefinitely.

For example:

With the setting 1:2, the trig condition is true the first time the pattern plays and then the third, the fifth, and so on.

With the setting 2:2, the trig condition is true the second time the pattern plays and then the fourth, the sixth, and so on.

With the setting 2:4, the trig condition is true the second time the pattern plays and then the sixth, the tenth, and so on.

With the setting 4:7 the trig condition is true the fourth time the pattern plays and then the eleventh, the eighteenth, and so on.



- Conditional parameter locks are a great way to add variety to a pattern. To set up a grid of mutually exclusive or conclusive note trigs across any of the synth tracks, and throwing some probability locks in there as well (perhaps, in turn, also sporting an array of logically conditioned trigs), is a neat way to make the most minimal of compositions come alive with randomness.
- Note that random or arbitrary variety is not the only way of using conditional trigs. They may also be used, for example, to have two different melodic or percussive sequences on the same track, one of which is activated only when FILL mode is active.

#### 10.10.4 FILL MODE

FILL mode can be used to create a temporary variation, such as a drum fill, in your pattern.

Press **[YES]** + **[PAGE]** to cue FILL mode for one pattern cycle. All <PATTERN PAGE> LEDs starts to flash. FILL mode becomes active (All <PATTERN PAGE> LEDs turns on) when the pattern loops, and remain active until it loops again. You can also press and hold the **[PAGE]** key when the pattern is playing (GRID RECORDING mode cannot be active) to activate FILL mode at any time, and for any duration. The FILL mode is active for as long as you hold the **[PAGE]** key.

Press and hold **[PAGE]** + **[YES]**, and then release **[PAGE]** before you release **[YES]** to latch FILL mode. Press **[PAGE]** again to unlatch FILL mode.

#### 10.10.5 SWING

Adjust the swing setting of the pattern, to employ a propulsive, rhythmic groove. Press **[TEMPO]** to access this menu.



Turn **DATA ENTRY** knob **E** to set the SWING ratio to 51-80%. The default setting is equal spacing, 50%.

#### 10.10.6 COPY, PASTE AND CLEAR OPERATIONS

Patterns, tracks, track pages, and trigs can be copied, pasted and cleared.

You can copy the active pattern to another location in the same bank or another bank. You can not be in GRID RECORDING mode if you want to perform a pattern copy operation. Copy the pattern by pressing **[FUNC]** + **[RECORD]**. Select another pattern, and then press **[FUNC]** + **[STOP]** to paste the copied pattern to this location. Please note that you can only paste to the currently active pattern. Clear a pattern by pressing **[FUNC]** + **[PLAY]**.

Individual sequencer tracks can be copied, pasted and cleared in the same way as patterns. GRID RECORDING mode must be active to perform these operations.

A single track page may also be copied, pasted and cleared. It is similar to copying/pasting/clearing a track, but only affects the active track page. Select the track page of choice by pressing the **[PAGE]** key. Copy by pressing **[PAGE]** + **[RECORD]**. Select a new track page and press **[PAGE]** + **[STOP]** to paste. Press **[PAGE]** + **[PLAY]** to clear the active track page.

Trigs, complete with all parameter lock settings, can also be copied, pasted and cleared. GRID RECORDING mode needs to be active to access this functionality. Press and hold a trig and press **[RECORD]** to

perform the copy operation. Paste by holding another [TRIG] key and pressing [STOP]. It is also possible to copy more than one trig. Hold several trigs and press [RECORD]. The trig first pressed acts as the starting point. When pasting, the other copied trigs are placed in relation to the trig first pressed. Paste the copied sequence of trigs by holding another [TRIG] key and pressing [STOP]. Clear trig locks by holding one or more trigs and press [PLAY].

You can undo any paste, and clear operation by repeating the key presses.



- It is possible to copy, clear and paste one or several patterns without leaving the active pattern. To copy, press and hold [PTN] + [TRIG] key to select the pattern you wish to copy. Then press [RECORD]. Let go of the [TRIG] key and then press and hold the [TRIG] key(s) to where you want to paste the pattern. Finally, press and hold [STOP] until the count down finishes to paste the pattern(s). To clear, press and hold [PTN] + [TRIG] key(s) to select the pattern(s) you wish to clear. Then press and hold [PLAY] to clear the pattern(s).

### 10.10.7 TEMPORARY SAVE AND RELOAD PATTERN COMMANDS

Patterns can instantly be saved to a temporary memory space and then reloaded again from this space.

- To perform a temporary save of the active pattern, press [FUNC] + [YES]. This is useful when you want to create a restore point when live tweaking, but without permanently save your changes.
- To perform a temporary reload of the active pattern, press [FUNC] + [NO]. It then reloads the pattern from when you last used the temporary save command. If you have not done any temporary save, then the pattern reloads from the permanently saved state.



The TEMPORARY SAVE PATTERN and TEMPORARY RELOAD PATTERN commands are great when improvising live. Any changes made to the active pattern, like adding bass line notes or using CONTROL ALL, can immediately be undone. The temporary saves and reloads do not affect the pattern in a permanent way.



The TEMPORARY SAVE PATTERN command does not save the pattern permanently, and any changes are lost if you load another project. If you wish to save your changes permanently, you should use SAVE TO PROJ in the PATTERN MENU. For more information, please see “10.7 PATTERN MENU” on page 32.

### 10.10.8 DIRECT TRACK TRANSPOSE

1. Press and hold [TRACK 1–4] key and then press [UP]/[DOWN] to initiate Direct track transpose. Only the selected track is transposed.
2. While still holding [TRACK 1–4], press [UP]/[DOWN] to transpose the track by semitones. You can see the amount of transpose at the top of the screen. You can also see (and set) the track transpose value on the TRACK NOTE menu. For more information, please see “10.4 TRACK NOTE MENU” on page 30.
3. Release [TRACK 1–4] for the transpose to take effect.

### 10.10.9 DIRECT PATTERN TRANSPOSE

1. Press [PTN] key and then press [UP]/[DOWN] to initiate Direct pattern transpose. All the tracks in the pattern, including the MIDI tracks, are transposed.
2. While still holding [PTN], press [UP]/[DOWN] to transpose the patterns tracks by semitones. You can see the amount of transpose at the top right of the screen.
3. Release [PTN] for the transpose to take effect.

## 10.11 CHAINS

Chains are sequences that consist of more than one pattern. You can use chains to preselect and automate in what order you want your patterns to play.



You can create one chain and it can contain any pattern in bank A–H. The chain can consist of up to 64 patterns.

#### 10.11.1 CREATING A CHAIN

1. Press **[BANK]** + **[TRIG 9–16]** key to select bank.
2. Press and hold **[PTN]** and then press a **[TRIG 1–16]** key to select the first pattern in the chain.
3. Release the **[PTN]** key and then press **[TRIG 1–16]** keys in the same order as you want the chained patterns to play. Keep a previous **[TRIG]** key pressed while you press the next one, the one after that and so on. You can press the same **[TRIG]** key again if you wish to add the pattern multiple times in a row. If you want to add a pattern from another bank, press **[BANK]** + **[TRIG 9–16]** to select bank, and then press **[TRIG 1–16]** to select pattern.
4. Press **[PLAY]** to start the sequencer and play the chain. The chain will be looped once the final pattern of the chain has played.



Please note that the chain will be lost when you create a new chain or when you select a new bank/pattern. Also, chains cannot be saved and are lost when you switch the Digitone off.



- It is possible to create chains while the sequencer is running.
- You can also use MIDI program change messages from an external device to change patterns on the Digitone. For more information, please see “14.3.1 SYNC” on page 60..

## 11. SYNTH TRACK PARAMETERS

Here follows a description of all of the parameters that are available on the synth tracks PARAMETER pages. The parameters on the TRIG page are saved with the pattern, and not with the sound. You can lock the synth track parameters to other settings on any step of the pattern by first pressing and holding a [TRIG] key, then changing the parameters' settings with the *DATA ENTRY* knobs. For more information, please see "10.10.1 PARAMETER LOCKS" on page 34.

### 11.1 EDITING THE SYNTH TRACK PARAMETERS

There are six PARAMETER page groups for the synth tracks. Press the [PARAMETER] keys to access the synth tracks PARAMETER pages. The SYN2, FLTR, AMP and LFO parameter groups has two pages. To access page one, press the [PARAMETER] key once. To access page two, press the [PARAMETER] key twice. Use the *DATA ENTRY* knobs A-H to change the parameters. Press and hold a [PARAMETER] key to see the values for all parameters on that page.

### 11.2 TRIG PARAMETERS PAGE 1

Here you find the parameters for the note trigs. Use the *DATA ENTRY* knobs to change the settings. The settings on the TRIG PARAMETERS page is not saved with the Sound. They are saved with the pattern.

Press [TRIG PARAMETERS] to access this parameter page.



#### 11.2.1 ROOT

Root sets the default note value that the note trigs placed in GRID RECORDING mode have. If you change the root note and have additional notes added on the same trig, then the additional notes are offset and transposed accordingly. For more information, please see "10.2.3 GRID RECORDING USING TRACK NOTE METHOD" on page 28. (C0–G10)

#### 11.2.3 VEL

Trig Velocity controls the velocity of the notes the MIDI track sends out. A setting of 0 equals a NOTE OFF command. (1–127)

#### 11.2.4 LEN

Trig Length sets the duration of the notes. When a note has finished playing a NOTE OFF command is sent. The INF setting equals infinite note length. (0.125–128, INF)

#### 11.2.5 COND

Trig Condition is a set of conditional rules that can be applied to any trig, using a parameter lock. Each setting is a logical condition, which determines whether or not the sequencer note is triggered. For more information, please see "10.10.3 CONDITIONAL LOCKS" on page 35.

#### 11.2.5 FLT.T

Filter Trig controls if the filter envelope is triggered or not. (ON, OFF)

#### 11.2.6 LFO.T

LFO Trig controls if the LFO is triggered or not. (ON, OFF)

### 11.3 SYN1 PAGE 1

The parameters on the SYN1 page control various aspects of the FM synthesis. You can find more information about the Digitone FM synthesis in "APPENDIX A: THE DIGITONE FM SYNTHESIS" on page 73 and "A.7 SYN1 PAGE 1 PARAMETERS OVERVIEW" on page 77.

Press [SYN1] once to access this parameter page.



### 11.3.1 ALGO

Algorithm selects the set structure of how the four operators are connected to each other. (1–8) For more information, please see “A.3 ALGORITHMS” on page 74.

### 11.3.2 RATIO C

Sets the frequency ratio for operator C. (0.25–16.0) For more information, please see “A.4 FM RATIOS” on page 74.

### 11.3.3 RATIO A

Sets the frequency ratio for operator A. (0.25–16.0) For more information, please see “A.4 FM RATIOS” on page 74.

### 11.3.4 RATIO B

Sets the frequency ratio for operator B1 and B2. The minimum value for B1 and B2 is .25. As you turn the encoder, B2 increases until it reaches the max (16). It then starts over from .25 and B1 increases to the next value (0.5). This revolving behavior continues until both operators reach the maximum value. This parameter behavior is similar to the movement of the hands on a watch. (0.25–16.0) For more information, please see “A.4 FM RATIOS” on page 74.

### 11.3.5 HARM

Harmonics controls waveform of the operators, C, A, and B1. The parameter is bipolar. Negative parameter values change the harmonics of operator C, while positive parameter values change the harmonics of operators A and B1. (-26.00–26.00) For more information, please see “A.6 HARMONICS” on page 76.

### 11.3.6 DTUN

Detune offsets the ratio of operator A and B2. Up until a parameter value of around 64, the offset is very slight to achieve subtle movement and drifting. Above 64 the operators start to detune more heavily. (0.00–127.00)

### 11.3.7 FDBK

Feedback sets the amount of self modulation of the operator that has feedback. This operator is shown in the algorithm on the screen with a feedback loop in its upper left corner. (0.00–120.00). For more information, please see “A.2 THE OPERATORS” on page 73.

### 11.3.8 MIX

Each algorithm has two carrier outputs (X and Y) that come from two different operators depending on what algorithm you chose. Use the **MIX** parameter to mix between these outputs so that you can cross-fade between two separate timbres. (50–64–63). For more information, please see “A.3 ALGORITHMS” on page 74.

## 11.4 SYN 2 PAGE 1

The parameters on the SYN2 pages control various aspects of the FM synthesis, mainly the amount of frequency modulation together with the operator envelopes and their behavior.

The FM engine has two operator envelopes. One is for operator group A, and one is for group B (B1 and B2). The envelopes are essentially expanded AD (Attack Decay) envelopes, but with an added adjustable end level (the amplitude level the sound reaches at the end of the decay stage). For more information, please see “A.5 THE OPERATOR ENVELOPES” on page 75.

Press [SYN2] once to access this parameter page.



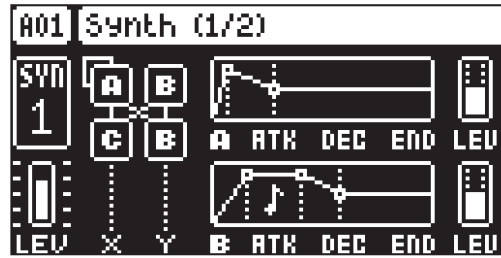

#### 11.4.1 ATK A

Attack Time sets the length of the attack phase of the modulation envelope for operator A. (0-127)

#### 11.4.2 DEC A

Decay Time sets the length of the decay phase of the modulation envelope for operator A. (0-127)

#### 11.4.3 END A

End Level sets the end level of the modulation envelope for operator A. (0-127)

#### 11.4.4 LEV A

Level sets the modulation amount from operator A. (0-127)

#### 11.4.5 ATK B

Attack Time sets the length of the attack phase of the modulation envelope for operator group B (B1 and B2). (0-127)

#### 11.4.6 DEC B

Decay Time sets the length of the decay phase of the modulation envelope for operator group B (B1 and B2). (0-127)

#### 11.4.7 END B

End Level sets the end level of the modulation envelope for operator group B (B1 and B2). (0-127)

#### 11.4.8 LEV B

Level sets the modulation amount from operator group B (B1 and B2). (0-127)

The **LEVEL** parameter for B is macro mapped to both operator B1 and B2 and control their modulation amount as per this graph:

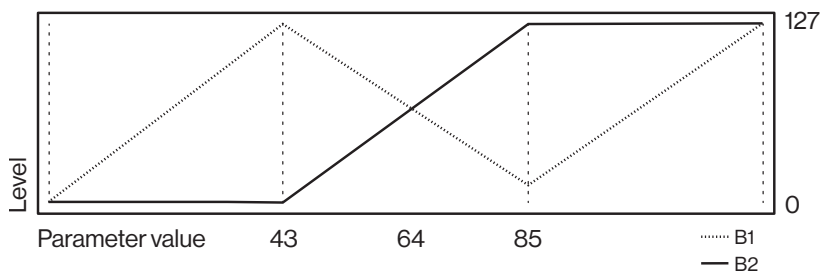

If you wish to use frequency modulation, it is important that you turn the LEV parameters up, since they set the amount of frequency modulation in the FM engine.

## 11.5 SYN2 PAGE 2

The parameters on the SYN2 pages control various aspects of the FM synthesis, mainly the amount of frequency modulation together with the operator envelopes and their behavior.

Press [SYN2] twice to access this parameter page.

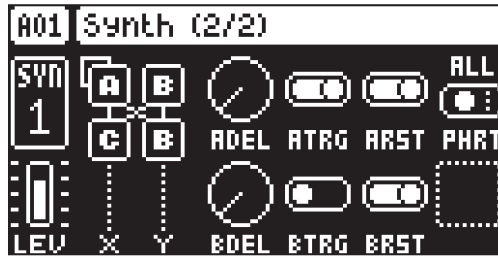

**11.5.1 ADEL**

Envelope delay sets the time before attack phase of the modulation envelope for operator A starts. (0-127)

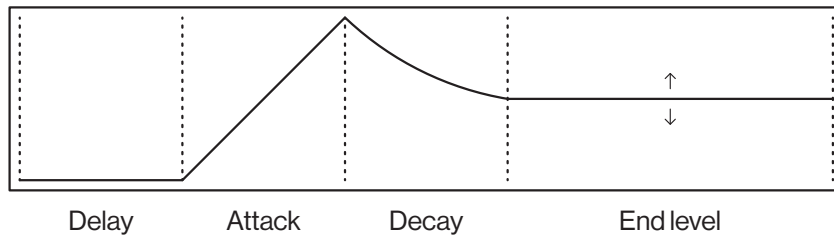

**11.5.2 ATRG**

Envelope trig sets the trig behavior of the operator envelopes. The envelopes can be either triggered or gated - making it either an ADE (Attack Decay End) or an ASDE (Attack Sustain Decay End) envelope. The sustain phase does not have an adjustable envelope level. It is instead the **LEV** parameter that sets the sustain level. The note length defines the length of the sustain phase.

Triggered (ATRIG/BTRIG ON)

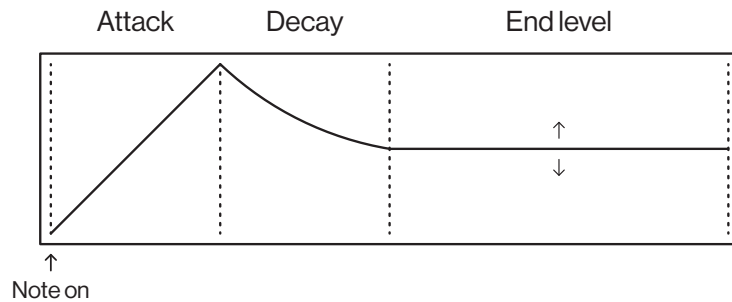

Gated (ATRIG/BTRIG OFF)

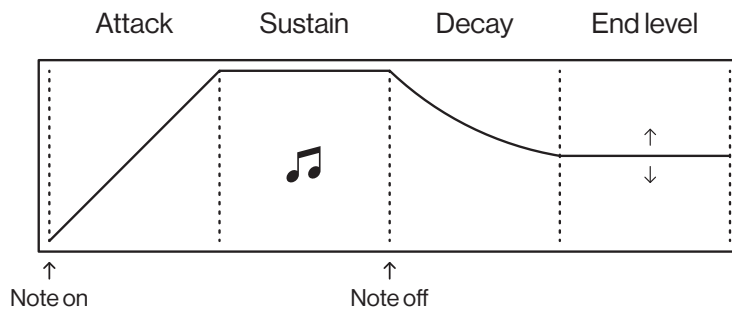

**11.5.3 ARST**

Envelope reset sets if the envelopes should reset or not when they are retriggered.

Reset on (ARST/BRST ON)

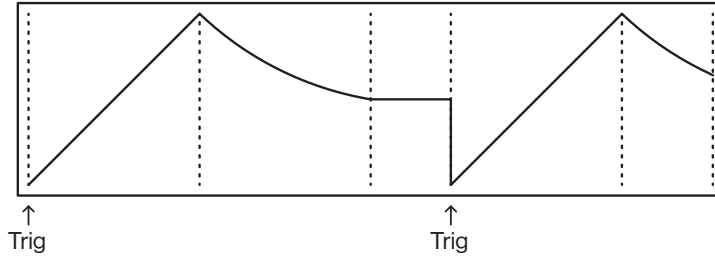

Reset off (ARST/BRST OFF)

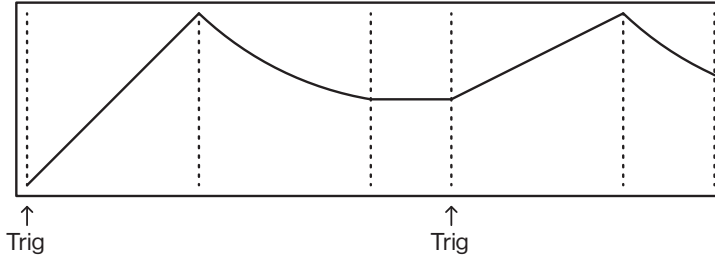

**11.5.4 PHRT**

Phase reset sets if the operators phase are reset to start at 0 or not when they are trigged.

OFF do not reset any operators

ALL resets all operators

C resets operator C

A+B resets operator A, B1, and B2

A+B2 resets operator A and B2

**11.5.5 BDEL**

Same as ADEL but for operator group B (B1 and B2).

**11.5.6 BTRG**

Same as ATRG but for operator group B (B1 and B2).

**11.5.7 BRST**

Same as ARST but for operator group B (B1 and B2).

**11.6 FLTR PAGE 1**

On FILTER page 1, you find all parameters that control the Multimode filter and its associated envelope.

Press [FLTR] once to access this parameter page.



**11.6.1 ATK**

Attack Time sets the length of the attack phase of the filter envelope. (0-127)

**11.6.2 DEC**

Decay Time sets the length of the decay phase of the filter envelope. (0-127)

**11.6.3 SUS**

Sustain Level sets the sustain level of the filter envelope. (0-127)

**11.6.4 REL**

Release Time sets the length of the release phase of the filter envelope. (0-126, INF)

**11.6.5 FREQ**

Frequency sets the cutoff frequency of the multimode filter. (0.00-127.00)

**11.6.6 RESO**

Resonance sets the resonance behavior of the filter. Resonance introduces a peak in the spectrum at the cutoff frequency. (0.00-127.00)

**11.6.7 TYPE**

Filter Type selects the type of filter. (OFF, 2-pole (12 dB) Lowpass, 2-pole (12 dB) Highpass, 4 pole (24 dB) Lowpass)

**11.6.8 ENV**

Env. Depth sets the amount of cutoff frequency modulation from the filter envelope. The parameter is bipolar, both negative and positive modulation depths are available. Range (-64.00-63.00)

**11.7 FLTR PAGE 2**

On the FILTER page 2, you find the parameters that control the 1-pole (6 dB) base-width filter.

Press [FLTR] twice to access this parameter page.

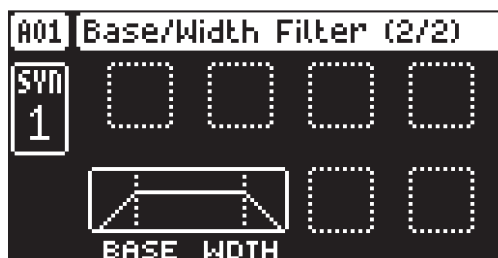

The base-width filter is basically a Highpass filter and a Lowpass filter connected in series. The filters **BASE** and **WIDTH** parameters define the base-width filters frequency range.

Examples of how the **BASE** and **WIDTH** parameters affect the filter frequency range:

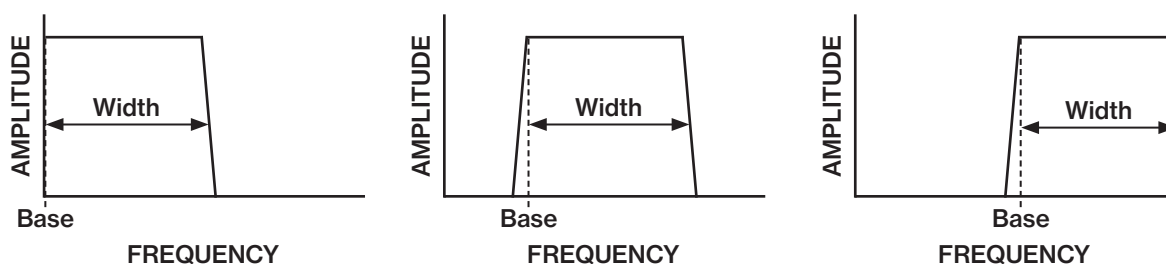

- With **BASE** set to 0, the filter functions as a low pass filter with **WIDTH** adjusting the frequency range.
- With **WIDTH** set to 127, the filter functions as a high pass filter with **BASE** adjusting the frequency range.
- With **BASE** set to 0 and **WIDTH** set to 127 the filter does not affect the sound.

**11.7.1 BASE**

Sets the base frequency of the filter. (0-127)

**11.7.2 WIDTH**

Sets the frequency width above the base frequency. (0-127)

## 11.8 AMP PAGE 1

The AMP page 1 controls parameters for the amplitude envelope, overdrive, tone, panning and volume. Press [AMP] once to access this parameter page.



### 11.8.1 ATK

Attack Time sets the length of the attack phase of the amp envelope. (0-127)

### 11.8.2 DEC

Decay Time sets the length of the decay phase of the amp envelope. (0-127)

### 11.8.3 SUS

Sustain Level sets the sustain level of the amp envelope. (0-127)

### 11.8.4 REL

Release Time sets the length of the release phase of the amp envelope. (0-126, INF)

### 11.8.5 DRV

Overdrive sets the amount of overdrive and clipping distortion of the signal entering the filter. (0.00-127.00)

### 11.8.6 PAN

Pan positions the sound in the stereo field. The knob function is bipolar with 0 being the balanced mid-point, L64 sends all sound to the left channel, and R63 sends all sound to the right channel. (L64-R63)

### 11.8.7 VOL

Volume sets the amount volume of the sound. This parameter is independent of the overall track level. (0.00-127.00)

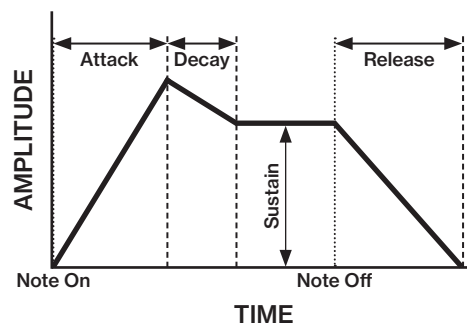

## 11.9 AMP PAGE 2

The AMP page 2 controls parameters for the effects sends and amp envelope reset volume.

Press [AMP] twice to access this parameter page.

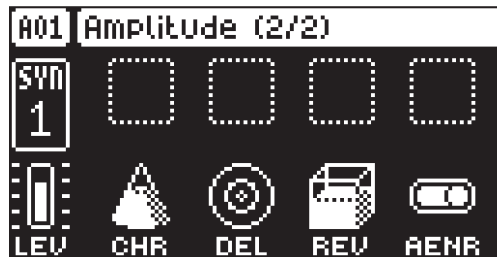

**11.9.1 CHR**

Chorus Send sets the amount of sound sent through to the Chorus effect. For more information, please see “13. FX PARAMETERS” on page 53. (OFF, 0.01-127.00)

**11.9.2 DEL**

Delay Send sets the amount of sound sent through to the Delay effect. For more information, please see “13. FX PARAMETERS” on page 53. (OFF, 0.01-127.00)

**11.9.3 REV**

Reverb Send sets the amount of sound sent through to the Reverb effect. For more information, please see “13. FX PARAMETERS” on page 53. (OFF, 0.01-127.00)

**11.9.4 AENR**

Amp envelope reset sets the amp envelope behavior:

ON resets the envelopes for each consecutive trig (default).

OFF does not reset the envelopes for each consecutive trig. It instead lets the envelope cycle complete.

**11.10 LFO PAGE 1**

The two Low-Frequency Oscillators can be used to modulate the parameters found on the synth tracks SYN1, SYN2, FILTER and AMP pages. Customize the low-frequency oscillators destination, wave, speed, and depth on this page.

Press [LFO] to access this parameter page.



**11.10.1 DEST1**

Destination selects the modulation destination for the LFO1. Preview how the LFO modulation affects the sound by highlighting a destination. Press [YES] to confirm the selection.

**11.10.2 WAVE1**

Waveform sets the LFO1 waveform. There are seven waveforms: Triangle, Sine, Square, Sawtooth, Exponential, Ramp, and Random.

**11.10.3 SPD1**

Speed sets the speed of the LFO1. Try settings of 8, 16 or 32 to sync the LFO to straight beats. The knob is bipolar. The LFO cycle can be played backward by using negative values. (-64.00-63.00)

**11.10.4 DEP1**

Depth sets the depth and polarity of the LFO1 modulation. Both negative (inverted) and positive modulation depth is possible. A center setting, 0.00, equals no modulation depth. (-64.00-63.00)

**11.10.5 DEST2**

Same as DEST1 but for LFO2.

**11.10.6 WAVE2**

Same as **WAVE1** but for LFO2.

**11.10.7 SPD2**

Same as **SPD1** but for LFO2.

**11.10.8 DEP2**

Same as **DEP1** but for LFO2.

**11.11 LFO PAGE 2**

The two Low-Frequency Oscillators can be used to modulate the parameters found on the synth tracks SYN1, SYN2, FLTR, and AMP pages. Customize the low-frequency oscillators speed multiplication, fade, start phase, and mode on this page.

Press [**LFO**] twice to access this parameter page.

**11.11.1 MULT1**

Multiplier multiplies the LFO1 SPD parameter by the set factor either by multiplying the current tempo (BPM settings) or by multiplying a fixed tempo of 120 BPM.

**11.11.2 FADE1**

Fade In/Out makes it possible to fade in/fade out the LFO1 modulation. The knob is bipolar. Positive values give a fade-out, negative values give a fade in. 0 gives no fade in/fade out. (-64–63)

**11.11.3 SPH1**

Start Phase sets the point within the wave cycle where the LFO1 starts when it is triggered. 0 makes the LFO start at the beginning of a complete wave cycle, 64 makes it start at the center. (0–127)

**11.11.4 MODE1**

Trig Mode sets how the LFO1 acts when triggered by a note

FRE is the default free-running mode. It makes the LFO run continuously, never restarting or stopping even if triggered by a note.

TRG makes the LFO restart when a note is triggered.

HLD makes the LFO run free in the background, but when a note is triggered the LFO output level is latched and held still until the next note is triggered.

ONE makes the LFO start from the beginning when a note is triggered, run for one cycle and then stop. This setting makes the LFO function similar to an envelope.

HLF makes the LFO start from the beginning when a note is triggered, run for half a cycle and then stop.

**11.11.5 MULT2**

Same as **MULT1** but for LFO2.

**11.11.6 FADE2**

Same as **FADE1** but for LFO2.

**11.11.7 SPH2**

Same as **SPH1** but for LFO2.

**11.11.8 MODE2**

Same as **MODE1** but for LFO2.

# 11. SYNTH TRACK PARAMETERS

LFO waveforms and trig modes.

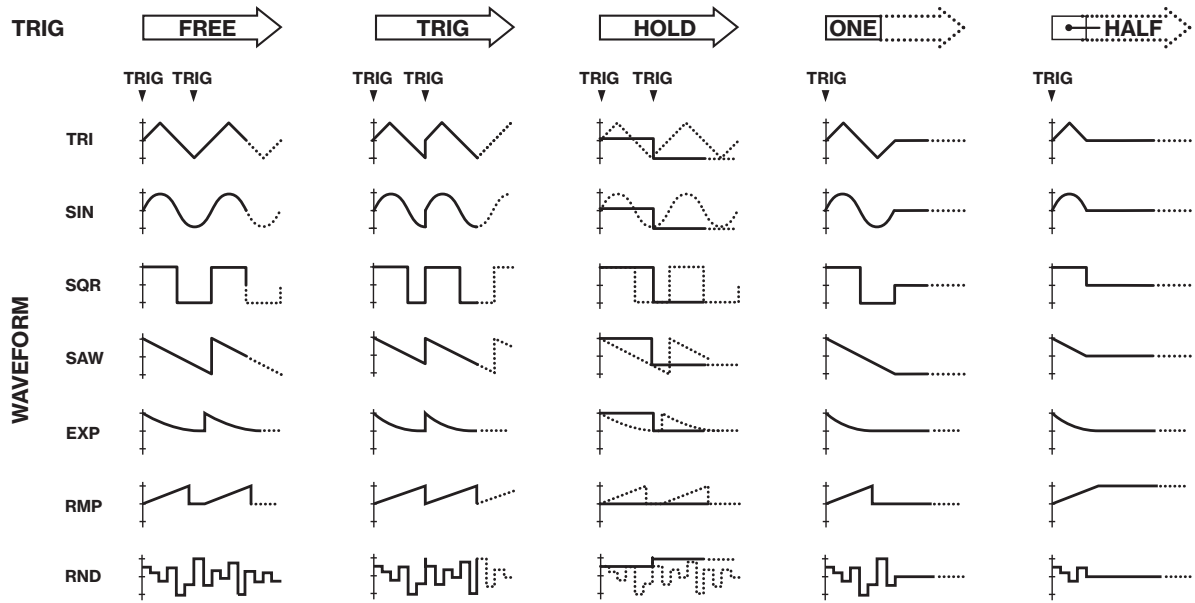

LFO speed (measured in whole note values) generated by combinations of the SPD and MULT settings.

		MULT											
		1	2	4	8	16	32	64	128	256	512	1K	2K
SPD	1	128	64	32	16	8	4	2	1	1/2	1/4	1/8	1/16
	2	64	32	16	8	4	2	1	1/2	1/4	1/8	1/16	1/32
	4	32	16	8	4	2	1	1/2	1/4	1/8	1/16	1/32	1/64
	8	16	8	4	2	1	1/2	1/4	1/8	1/16	1/32	1/64	1/128
	16	8	4	2	1	1/4	1/4	1/8	1/16	1/32	1/64	1/128	1/256
	32	4	2	1	1/4	1/8	1/8	1/16	1/32	1/64	1/128	1/256	1/512
	64	2	1	1/4	1/8	1/16	1/16	1/32	1/64	1/128	1/256	1/512	1/1024



## 12. MIDI TRACK PARAMETERS

Here follows a description of the parameters that are on the MIDI tracks PARAMETER pages. The MIDI tracks parameters are saved together with the pattern. You can press and hold a [TRIG] key, and then change the parameters settings with the *DATA ENTRY* knobs to lock the parameters to other settings on any step of the pattern. For more information, please see “10.10.1 PARAMETER LOCKS” on page 34.

### 12.1 EDITING THE MIDI TRACK PARAMETERS

There are five PARAMETER pages for the MIDI tracks. Press the [PARAMETER] keys to access the MIDI tracks PARAMETER pages. Use the *DATA ENTRY* knobs *A-H* to change the parameters. Press and hold a [PARAMETER] key to see the values for all parameters on that page.

### 12.2 TRIG PARAMETERS PAGE

Here you find the parameters for the note trigs. Change settings using the *DATA ENTRY* knobs. These general settings affect note trigs placed in the sequencer.

Press [TRIG PARAMETERS] to access this parameter page.



#### 12.2.1 ROOT

Root sets the default note value that the note trigs placed in GRID RECORDING mode have. If you change the root note and have additional notes added on the same trig, then the additional notes are offset and transposed accordingly. (C0–G10)

#### 12.2.3 VEL

Trig Velocity controls the velocity of the notes the MIDI track sends out. A setting of 0 equals a NOTE OFF command. (1–127)

#### 12.2.4 LEN

Trig Length sets the duration of the notes. When a note has finished playing a NOTE OFF command is sent. The INF setting equals infinite note length. (0.125–128, INF)

#### 12.2.5 COND

Trig Condition is a set of conditional rules that can be applied to any trig, using a parameter lock. Each setting is a logical condition, which determines whether or not the sequencer note is triggered. For more information, please see “10.10.3 CONDITIONAL LOCKS” on page 35.

#### 12.2.6 LFO.T

LFO Trig controls if the LFO is triggered or not. (ON, OFF)

### 12.3 SYN1 PAGE (MIDI SOURCE)

Here you can set the MIDI channel that the MIDI track should use to send data. Bank and program change values are also set here, together with a few standard CC parameters. The default value of the parameters on this page is OFF, meaning they are disabled and do not send out any data. Press and hold [FUNC] and then press the *DATA ENTRY* knobs to enable them. You can then use the *DATA ENTRY* knobs to set the parameter values as usual. Disable the parameters again by repeating the activation procedure.

Press [SYN1] or [SYN2] once to access this parameter page.



**12.3.1 CHAN**

Channel sets the MIDI channel the track sends MIDI data to. If you set this parameter to OFF, it turns the MIDI track off. Please note that this parameter cannot be parameter locked. (OFF, 1-16)

**12.3.2 BANK**

Bank is used to send out a bank change message. (OFF, 1-128)

**12.3.3 PROG**

Program change is used for sending out a program change message. (OFF, 1-128)

**12.3.4 PB**

Pitch Bend controls the pitch bend data sent on the MIDI track. (OFF, -128.00-128.00)

**12.3.5 AT**

Aftersustain controls the aftersustain data sent on the MIDI track. (OFF, 0-127)

**12.3.6 MW**

Mod Wheel controls the modulation wheel data sent on the MIDI track. (OFF, 0-127)

**12.3.7 BC**

Breath controller controls the breath control data sent on the MIDI track. (OFF, 0-127)

**12.4 FLTR PAGE (CC VALUE)**

Here you can set the values of up to eight assignable CC commands. The default value of the parameters on this page is OFF, meaning they are disabled and do not send out any data. Press and hold [FUNC] and then press the *DATA ENTRY* knobs to enable them. You can then use the *DATA ENTRY* knobs to set the parameter values as usual. Disable the parameters again by repeating the enabling procedure.

Press [FLTR] to access this parameter page.

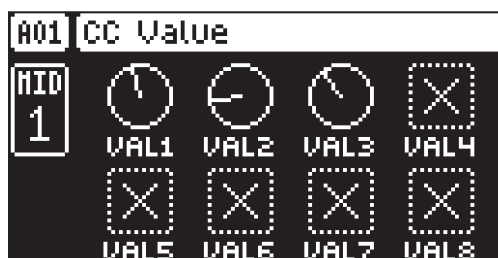

**12.4.1 VAL1-VAL8**

CC 1-8 Value controls the values that the CC commands send. You specify the CC commands themselves on the AMP (CC SELECT) page. These parameters default value is OFF. Press [FUNC] + *DATA ENTRY* knobs to activate the parameters and then turn the *DATA ENTRY* knobs to set a value. (OFF, 0-127)

**12.5 AMP PAGE (CC SELECT)**

Here you select the eight CC commands whose values you set with the parameters on the FLTR PAGE (CC VALUE) page. Press the corresponding knob or [ENTER/YES] to activate the parameter change.

Press [AMP] to access this parameter page.

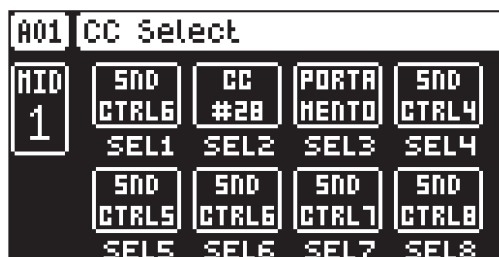

### 12.5.1 SEL1-SEL8

CC 1–8 Select specifies the CC commands whose values you control controlled by the parameters on the AMP PAGE 1 (CC VALUE) page. The selectable commands are the standard MIDI Control Change Messages. (0–119)

## 12.6 LFO PAGE

The Low-Frequency Oscillator can be used to interact with the parameters found on the MIDI tracks' SYN1, and FLTR pages. Customize the low-frequency oscillator behavior, orientation, and depth on this page.

Press [LFO] to access this parameter page.

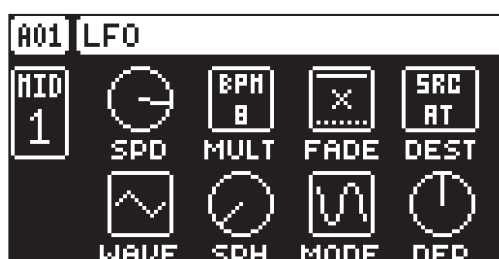

### 12.6.1 SPD

Speed sets the speed of the LFO. Try settings of 8, 16 or 32 to sync the LFO to straight beats. The knob is bi-polar. The LFO cycle can be played backward by using negative values. (-64.00–63.00)

### 12.6.2 MULT

Multiplier multiplies the SPD parameter by the set factor either by multiplying the current tempo (BPM settings) or by multiplying a fixed tempo of 120 BPM.

### 12.6.3 FADE

Fade In/Out makes it possible to fade in or out the LFO modulation. The knob is bipolar. Positive values give a fade out. Negative values give a fade in. 0 gives no fade in/fade out. (-64–63)

### 12.6.4 DEST

Destination selects the modulation destination for the LFO. Preview how the LFO modulation affects the sound by highlighting a destination. Press [YES] to confirm the selection.

### 12.6.5 WAVE

Waveform sets the LFO waveform. There are seven waveforms: Triangle, Sine, Square, Sawtooth, Exponential, Ramp, and Random.

### 12.6.6 SPH

Start Phase sets the point within the wave cycle where the LFO starts when it is triggered. 0 makes the LFO start at the beginning of a complete wave cycle, 64 makes it start at the center. (0–127)

### 12.6.7 MODE

Trig Mode sets how the LFO acts when a note is triggered.

FRE is the default free-running mode. It makes the LFO run continuously. It will not restart or stop even if it is triggered by a note.

TRG makes the LFO restart when a note trigs it.

HLD makes the LFO run free in the background, but when a note is triggered the LFO output level is latched and held still until the next note is triggered.

ONE makes the LFO start from the beginning when a note is triggered, run for one cycle and then stop. This setting makes the LFO function similar to an envelope.

HLF makes the LFO start from the beginning when a note is triggered, run for half a cycle and then stop.

For more information about the Trig Modes, please see the illustration at the end of section “11.11 LFO PAGE 2” on page 47.

### **12.6.8 DEP**

Depth sets the depth and polarity of the LFO modulation. Both negative (inverted) and positive modulation depth is possible. A center setting, 0.00, equals no modulation depth. (-64.00–63.00)

## 13. FX PARAMETERS

Here follows a description of the parameters on the CHORUS, DELAY, REVERB, and MASTER PARAMETER pages.

### 13.1 EDITING THE FX PARAMETERS

The Digitone's Chorus, Delay, and Reverb are send effects and are on a pattern level. It means that all the Sounds in a pattern shares the same effect settings but have individual send levels to the effects. You set the Chorus, Delay, and Reverb parameters on their respective PARAMETER page, but their incoming signals are set by the CHR, DEL, and REV send parameters on the AMP page of each synth track. Press [FUNC] + [SYN2] to edit the Chorus. Press [FUNC] + [FLTR] to edit the Delay. Press [FUNC] + [AMP] to edit the Reverb. Use the *DATA ENTRY* knobs *A-H* to change the parameters.



The FX parameter settings are stored as part of the pattern. Don't forget to save the pattern and give it a unique name once you have achieved the desired results.

### 13.2 CHORUS

The chorus can be used to widen sounds, enhance the stereo image or add subtle movement to sounds. Press [FUNC] + [SYN2] to access this parameter page.

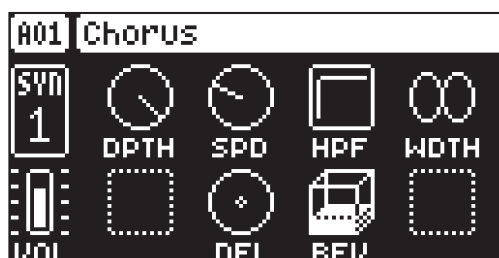

#### 13.2.1 DPTH

Depth sets the depth of the LFO modulation of the chorus.

#### 13.2.2 SPD

Speed sets the speed of the LFO modulation of the chorus.

#### 13.2.3 HPF

High-pass filter sets the highpass filtering of the input signal.

#### 13.2.4 WPTH

Width sets the stereo width of the chorus.

#### 13.2.5 VOL

Mix Volume adjusts the volume of the chorus signal.

#### 13.2.6 DEL

Delay Send sets how much of the wet chorus signal to send through to the delay.

#### 13.2.7 REV

Reverb Send sets how much of the wet chorus signal to send through to the reverb.

### 13.3 DELAY

The delay send effect takes the input signal, delays it in time and then adds it to the original signal.

Press [FUNC] + [FLTR] to access this parameter page.



### 13.3.1 TIME

Delay Time sets the delay time. The delay time settings are relative to the current BPM and is measured in 128th notes. (1.00–128.00)

TIME setting	Divide ratio
1	1/128
2	1/64
2.67	1/48 (1/32T)
3	1/64.
4	1/32
5.33	1/24 (1/16T)
6	1/32.
8	1/16
10.67	1/12 (1/8T)
12	1/16.
16	1/8
21.33	1/6 (1/4T)
24	1/8.
32	1/4
42.67	1/3 (1/2T)
48	1/4.
64	1/2
96	1/2.
128	1

### 13.3.2 X

Ping-pong sets the delay signal to alternate across the stereo field. There are two settings:

OFF lets you manually set the position of the delay signal in the stereo field. Use the WID parameter to change the stereo field position.

ON makes the delay signal alternate between left and right pan positions. The WID parameter controls the amount of panning.

### 13.3.3 WID

Stereo Width sets the delay signal pan width across the stereo field. The knob is bipolar. (-64.00–63.00)

### 13.3.4 FDBK

Feedback Gain sets the amount of delay output signal to feed back into the input of the delay. With higher parameter settings, infinite and swelling delays are possible. Please be aware that high feedback can lead to a very loud signal. (0–198)

### 13.3.5 VOL

Mix Volume adjusts the volume of the Delay output signal. (0.00–127.00)

### 13.3.6 HPF

Feedback HPF sets the cutoff frequency of the delay highpass filter. (0.00–127.00)

**13.3.7 LPF**

Feedback LPF sets the cutoff frequency of the delay lowpass filter. (0.00–127.00)

**13.3.8 REV**

Reverb Send sets the amount of Delay output signal to be sent to the Reverb. (0.00–127.00)

**13.4 REVERB**

The reverb send effect controls the persistence, and ambient characteristics, of the sound reverberations. It can simulate many different sonic locations, from huge spaces to small rooms.

Press **[FUNC]** + **[AMP]** to access this parameter page.

**13.4.1 PRE**

Pre-delay sets the pre-delay time of the Reverb. (0.00–127.00)

**13.4.2 DEC**

Decay Time sets the length of the decay phase of the reverberated signal, essentially setting the size of the acoustic space. (1–127, INF)

**13.4.3 FREQ**

FB Shelving Freq sets the shelving filter frequency. Together with the GAIN parameter, it can be used to dampen the reverberated signal above a chosen frequency, making the reverberation sound more prominent or more muffled. (0.00–127.00)

**13.4.4 GAIN**

FB Shelving Gain affects the damping of the reverberated signal above the shelving frequency set by the FREQ parameter. At max value the treble is included in the reverberations; lowering the value gradually dampens it. (0.00–127.00)

**13.4.5 VOL**

Mix Volume sets the volume of the Reverb output signal. (0.00–127.00)

**13.4.6 HPF**

Input HPF sets the cutoff frequency of the reverb high-pass filter. (0.00–127.00)

**13.4.7 LPF**

Input LPF sets the cutoff frequency of the reverb low-pass filter. (0.00–127.00)

**13.5 MASTER**

The MASTER page is not strictly an FX parameter page, but it does contain the master Overdrive effect. Here you can also set the level and pan of the incoming audio from the **INPUT L/R** inputs. The chorus/delay/reverb send parameters for the audio coming from **INPUT L/R** are also located here.

Press **[FUNC]** + **[LFO]** to access this parameter page.



### 13.5.1 IN L

Volume input L sets the level of the audio from the **INPUT L** audio input.

### 13.5.2 IN R

Volume input R sets the level of the audio from the **INPUT R** audio input.

### 13.5.3 LPAN

Left pan sets the pan of the audio from the **INPUT L** audio input. (L64–R63)

### 13.5.4 RPAN

Right pan sets the pan of the audio from the **INPUT R** audio input. (L64–R63)

### 13.5.5 VOL

Pattern volume sets the patterns overall audio level. This parameter basically has the same function as the *MASTER VOLUME* knob.

### 13.5.6 CHO

Chorus Send sets the amount of sound from the **INPUT L/R** audio inputs sent through to the chorus effect. The audio from the **INPUT L/R** audio inputs is summed to mono before it is sent to the effect. For more information, please see “13.2 CHORUS” on page 53. (0.00–127.00)

### 13.5.7 DEL

Delay Send sets the amount of sound from the **INPUT L/R** audio inputs sent through to the delay effect. The audio from the **INPUT L/R** audio inputs is summed to mono before it is sent to the effect. For more information, please see “13.3 DELAY” on page 53. (0.00–127.00)

### 13.5.8 REV

Reverb Send sets the amount of sound from the **INPUT L/R** audio inputs sent through to the reverb effect. The audio from the **INPUT L/R** audio inputs is summed to mono before it is sent to the effect. For more information, please see “13.4 REVERB” on page 55. (0.00–127.00)

### 13.5.9 OVR

Overdrive introduces distortion at the very end of the Digitone signal path. (0.00–127.00)



## 14. GLOBAL SETTINGS MENU

The GLOBAL SETTINGS menu offers settings that affect Digitone and are also used to manage Projects. Press [GLOBAL SETTINGS] to access the GLOBAL SETTINGS menu. Scroll the list by using [UP]/[DOWN] or the *LEVEL/DATA* knob. Open a highlighted menu by pressing [YES].



### 14.1 PROJECT



#### 14.1.1 LOAD PROJECT

Load Project opens a project selection screen where you can choose a project to load. Note that the active project is not saved before loading the new project so remember to save the active project first. If you wish to create a new project, select CREATE NEW at the very bottom of the list. The new project is a blank slate.



If you load a new project, it overwrites the active project. Be sure to save your active project before you load another project.

#### 14.1.2 SAVE PROJECT AS

Save Project opens a project selection screen where you choose a slot to save the active project too. You can also press [FUNC] + [GLOBAL SETTINGS] to access this screen.

#### 14.1.3 MANAGE PROJECTS

MANAGE PROJECTS launches the PROJECT MANAGER menu. If you select a project in this menu and press the [RIGHT] arrow key a list of commands appear.

**CLEAR** Resets the project slot to a clean state.

**DELETE** Removes the project from the slot.

**RENAME** Opens a NAMING screen where you can rename the project file.

**LOAD FROM** Loads the selected project. Please note that this overwrites the active project.

**SAVE TO** Saves the active project to the selected slot.

**TOGGLE** Toggles write protection on or off. You can not overwrite, rename or erase write protected projects A lock symbols in front of the project name shows that the project is write protected.

**INIT NEW** Initializes an empty file slot with a clean project. This option is only available for empty project slots.

## 14.2 SOUNDS

In this menu you can browse and manage Sounds in the +Drive Sound library or the Sound pool of the active project. Other menu options let you clear the track Sound and rename the track Sound. Use the [UP] and [DOWN] arrow keys to move between the options. Press [YES] to confirm your selection. Press [NO] to exit the menu.



14.2.1 SOUND BROWSER



Press **[FUNC] + LEVEL/DATA** to open the SOUND BROWSER. The SOUND BROWSER is used to preview and load Sounds. This menu shows a list of all sounds in the +Drive Sound library or the Sound pool. Scroll the list by turning the **LEVEL/DATA** knob or by pressing **[UP]/[DOWN]**. You can preview a Sound by highlighting it in the list and use the **[TRIG]** keys to play the Sound chromatically. Press **[TRACK NOTE] + [UP]/[DOWN]** to change octave up and down on the Sound you preview. Press **[YES]** to load the highlighted Sound.

Press **[LEFT]** to access the SORTING menu. Press **[YES]** to execute the commands. Press **[NO]** or the **[RIGHT]** arrow key to exit the menu.



**VIEW POOL** lists Sounds available in the Sound pool of the active project. The command is only available when you browse the +Drive Sound library.

**VIEW +DRIVE** lists Sounds available on the +Drive Sound library. The command is only available when you browse the Sound pool of the active project.

**SORT ABC** sorts the Sounds in alphabetical order. This option is only available when SORT 123 is active.

**SORT 123** sorts the Sounds by slot number. This option is only available when SORT ABC is active.

**FILTER** opens a list where Sounds are arranged according to tags. Select and deselect tags by pressing **[YES]**. Multiple tags can be selected. Exit the tag list by pressing **[NO]**.

**SEARCH** gives you the option to perform a text search and list all Sounds with names matching or including the text input. For more information, please see “6.5 THE NAMING SCREEN” on page 17 on how to enter text.



- Press the **[TRIG]** keys to preview the currently selected Sound. Please note that the active tracks current effects settings affect the previewed Sound
- Press **[BANK] + [TRIG 9-16]** to select Sound bank.
- You can also press a **[TRACK]** key twice quickly to open the SOUND BROWSER. The SOUND BROWSER can also be accessed by pressing **[FUNC] + LEVEL/DATA**.

### 14.2.2 SOUND MANAGER

Press [GLOBAL SETTINGS] and then select SOUND MANAGER to open the SOUND MANAGER. You use the SOUND MANAGER to manage sounds, for example, import, export, rename, and tag sounds. Select **MANAGE SOUNDS** and press [YES] to open the SOUND MANAGER. Sounds can be saved, loaded, renamed, tagged et cetera. Opening this menu shows a list of all sounds found in the +Drive Sound library or the Sound pool. Turn the **LEVEL/DATA** knob or press [UP]/[DOWN] to scroll through the list. You can preview a Sound by highlighting it in the list and use the [TRIG] keys to play the Sound chromatically. Press [TRACK NOTE] + [UP]/[DOWN] to change octave up and down on the Sound you preview.

A:001	DIGIT-ONE	EPIC
A:002	CHAPPET DL	TRTR ATHD
A:003	SQB TK	BASS
A:004	PLUCKY E	PERC SYNT
A:005	SIMPLE LEAD JH	
A:006	SLIGHT DL	LEAD ATHD
A:007	LIGHT BELL S	METL ACOU
A:008	R&ASS HZ	BASS SFX

Press [LEFT] to access the SORTING menu. Press [YES] to execute the commands. Press [NO] or the [RIGHT] arrow key to exit the menu.

VIEW POOL	NAME	EPIC
SORT ABC	RET DL	TRTR ATHD
FILTER	K	BASS
SEARCH	Y E	PERC SYNT
	E LEAD JH	
	IT DL	LEAD ATHD
	T BELL S	METL ACOU
	S HZ	BASS SFX

**VIEW POOL** lists Sounds available in the Sound pool of the active project. The command is only available when you browse the +Drive Sound library.

**VIEW +DRIVE** lists Sounds available on the +Drive Sound library. The command is only available when you browse the Sound pool of the active project.

**SORT ABC** sorts the Sounds in alphabetical order. This option is only available when SORT 123 is active.

**SORT 123** sorts the Sounds by slot number. This option is only available when SORT ABC is active.

**FILTER** opens a list where Sounds are arranged according to tags. Select and deselect tags by pressing [YES]. You can select multiple tags. Exit the tag list by pressing [NO].

**SEARCH** gives you the option to perform a text search and list all Sounds with names matching or including the text input. For more information, please see "6.5 THE NAMING SCREEN" on page 17 on how to enter text.

Press [RIGHT] to access the SOUND OPERATIONS menu. The available operations affects the selected Sound. Press [YES] to apply the commands to the selected Sound. Press [NO] or the [LEFT] arrow key to exit the menu.

A:001	DIGIT-ONE	IMPORT TO TRK
A:002	CHAPPET I	COPY TO ...
A:003	SQB TK	EXPORT TO HERE
A:004	PLUCKY E	RENAME
A:005	SIMPLE LI	EDIT TAGS
A:006	SLIGHT DI	DELETE
A:007	LIGHT BEI	SELECT ALL
A:008	R&ASS HZ	DESELECT ALL

**IMPORT TO TRACK** loads the selected Sound to the active track and makes it a part of the active pattern.

**COPY TO...** Copies the selected Sounds to one of the following:

SOUND POOL copies the selected Sounds to the first free slots of the Sound pool.

+DRIVE copies the selected Sounds to the first free slots of the +Drive Sound library.

+BANK (A-H) copies the selected Sounds to the first free slots of a specific bank inside the +Drive.

**EXPORT TO HERE** exports the active track Sound and saves it to the selected slot.

**RENAME** Opens a screen where you can rename the selected Sound.

**EDIT TAGS** opens a menu where Sounds can be tagged. Sounds can have any number of tags, but only the first two shows on the sound list. Press [YES] to apply or remove tags. Highlight <SAVE> and press [YES] to save

**DELETE** deletes the Sound.

**SELECT ALL** selects all Sounds in the list.

**DESELECT ALL** deselects all Sounds in the list.

**TOGGLE** enables or disables write protection for the selected Sounds. When a Sound is write-protected, it cannot be overwritten, renamed, tagged or deleted. A write-protected Sound has a padlock symbol next to its name

**SEND SYSEX** sends the selected Sounds as SysEx data.



- Sounds in the +Drive Sound library are organized into eight banks, ranging from A to H. Each bank can contain 256 Sounds. Press [BANK] + [TRIG 9-16] keys to view the Sounds in a specific bank.
- Press the [TRIG] keys to preview the currently selected Sound. Please note that the active tracks current effects settings affect the previewed Sound
- Several Sounds can be simultaneously affected by the commands available in the SOUND OPERATIONS menu. Select/deselect individual Sounds by highlighting them and pressing [YES].
- Press [FUNC] + [UP]/[DOWN] for faster scrolling in the sound list.

### 14.2.3 CLEAR TRACK SOUND

Sets the PARAMETER page parameters of the active track to their default values. When selecting this option, a prompt will appear. Press [YES] to initialize the parameters or [NO] to cancel the operation. Note that no parameter information will be permanently lost until the Sound is saved to the same slot it was loaded from.

### 14.2.4 RENAME TRACK SOUND

Opens the NAMING menu where you can rename the Sound of the active track.

### 14.2.5 SETUP

Opens the SOUND SETUP menu. For more information, please see “9.5 SOUND SETUP MENU” on page 24.

## 14.3 MIDI CONFIG

In this menu you find various sub-menus dealing with the MIDI functionality.



### 14.3.1 SYNC

Controls how Digitone receives and sends MIDI clock and transport commands. Change settings by using the [LEFT]/[RIGHT] arrow keys or the [YES] key.

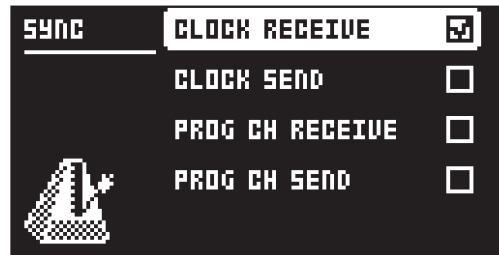

**CLOCK RECEIVE** sets whether or not Digitone responds to MIDI clock sent from external devices.

**CLOCK SEND** sets whether or not Digitone transmits MIDI clock.

**PROG CH RECEIVE** sets whether or not Digitone responds to incoming program change messages, which is useful when wanting to select patterns externally. The MIDI channel that listens to incoming program change messages is set in the MIDI CHANNELS menu. For more information, please see “14.3.3 CHANNELS” on page 62.

**PROG CH SEND** sets whether or not Digitone sends program change messages when patterns change. You set the MIDI channel that sends program change messages in the MIDI CHANNELS menu. For more information, please see “14.3.3 CHANNELS” on page 62.

### 14.3.2 PORT CONFIG

In this menu you find the MIDI port related settings. Change settings by using the [LEFT]/[RIGHT] arrow keys.

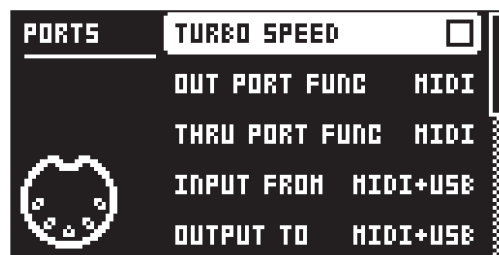

**TURBO SPEED** press [YES] to start the turbo speed negotiation. The device chooses the optimal speed automatically. Please note that you must use a MIDI interface that supports the Turbo-MIDI protocol.

**OUT PORT FUNCTIONALITY** selects what type of signal the MIDI OUT port sends.

MIDI makes it possible for the port to send out MIDI data.

DIN 24 makes the port send DIN 24 sync pulses. No MIDI data is transferred over the port when this option is selected.

DIN 48 makes the port send DIN 48 sync pulses. No MIDI data is transferred over the port when this option is selected.

**THRU PORT FUNCTIONALITY** selects what type of signal the MIDI THRU port sends. The settings are the same as for OUT PORT FUNCTIONALITY.

**INPUT FROM** selects the input MIDI data port.

DISABLED receives no MIDI data.

MIDI receives MIDI data from the MIDI IN port.

USB receives MIDI data from the USB port.

MIDI+USB receives MIDI data from the MIDI IN and USB ports.

**OUTPUT TO** selects the output MIDI data port.

DISABLED sends no MIDI data.

MIDI sends MIDI data to the MIDI OUT port.

USB sends MIDI data to the USB port.

MIDI+USB sends MIDI data to the MIDI OUT and USB ports.



Make sure to use the **USB only** setting for the **INPUT FROM** or **OUTPUT TO** settings on the **MIDI PORT CONFIG** menu when you send or receive large amounts of data for higher transfer speeds.

**OUTPUT CH** selects whether the knobs sends data on the **AUTO** channel or the track channel.

**PARAM OUTPUT** selects what type of MIDI messages the **DATA ENTRY** knobs sends. For information about which **CC/NRPN** parameters that are sent, please see “APPENDIX B: MIDI IMPLEMENTATION” on page 79.

**NRPN** sends **NRPN** MIDI messages.

**CC** sends **CC** MIDI messages.

**ENCODER DEST** controls whether the **DATA ENTRY** and **LEVEL/DATA** knobs send MIDI data or not. When set to **INT**, the knobs only affect the Digitone and send no MIDI data. When set to **INT + EXT**, the knobs affect the Digitone and also sends MIDI data to external devices.

**TRIG KEY DEST** controls whether the **[TRIG]** keys sends MIDI data or not. When set to **INT**, the **[TRIG]** keys only affect the Digitone and sends no MIDI data. When set to **INT + EXT**, the **[TRIG]** keys affect the Digitone, and also send MIDI data to external devices. When set to **EXT**, the **[TRIG]** keys send MIDI data to external devices but do not affect the Digitone.

**MUTE DEST** controls whether activating/deactivating mutes send MIDI data or not. When set to **INT**, mutes only affect the Digitone and no MIDI data is sent. When set to **INT + EXT**, mutes affect the Digitone and also send MIDI data to external devices. When set to **EXT**, mutes send MIDI data externally, but do not affect the Digitone.

**RECEIVE NOTES** sets whether or not it is possible to use an external MIDI keyboard or controller to play the Digitone.

**RECEIVE CC/NRPN** sets whether or not it is possible to use an external MIDI device to control Digitone parameters with **CC/NRPN** data.

### 14.3.3 CHANNELS

This menu handles the MIDI channel configuration.

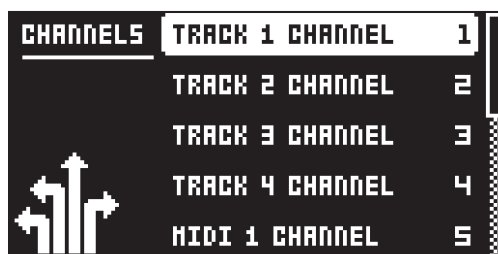

**TRACK 1–4 CHANNEL** selects dedicated MIDI track channel that controls the synth tracks. It also sets the MIDI channel for the MIDI messages the **DATA ENTRY** knobs on the chosen track send. An **OFF** setting makes the track disregard any incoming MIDI messages.

**MIDI 1–4 CHANNEL** selects dedicated MIDI track channel that controls the MIDI tracks. It also sets the MIDI channel for the MIDI messages the **DATA ENTRY** knobs on the chosen track send. An **OFF** setting makes the track disregard any incoming MIDI messages.

**FX CHANNEL** selects dedicated MIDI track channel that controls the FX parameters. It also sets the MIDI channel for the MIDI messages the **DATA ENTRY** knobs on the FX pages send. An **OFF** setting makes the track disregard any incoming MIDI messages.

**AUTO CHANNEL** selects the MIDI channel that gives access to the currently active track. If an external MIDI keyboard connected to Digitone sends MIDI data on this channel, the keyboard controls the active track. This function is useful when you want to change quickly between the active synth tracks to play different S20

ounds. The Digitone also uses the **AUTO** channel to record to the MIDI tracks from external MIDI controllers. The default **AUTO** channel is 10.

**PROG CH IN CH** selects the MIDI channel that listens for incoming program change messages. An **AUTO** setting uses the **AUTO** channel. Enable Digitone to respond to program change messages in the **MIDI SYNC** menu. For more information, please see “14.3.1 SYNC” on page 60.

**PROG CH OUT CH** selects the MIDI channel that sends program change messages when changing patterns. The **AUTO** setting uses the **AUTO** channel. Enable Digitone to send program change mes-

sages in the SYNC menu. For more information, please see “14.3.1 SYNC” on page 60.

## 14.4 SYSEX DUMP

In the SYSEX DUMP menu, projects, patterns, and Sounds can be sent and received. Select a menu option using [UP]/[DOWN] or the *TRACK LEVEL* knob. Press [YES] to open the highlighted menu selection.



When receiving or sending SysEx data, the MIDI ports or the USB port of the Digitone should be connected to the external sending/receiving device.

If the Digitone is sending or receiving SysEx data through the MIDI ports, use the Elektron TM-1 USB MIDI interface for up to 10x transfer speeds.

If the external device is a computer, we recommend using our free SysEx utility C6, which can be downloaded from the Elektron website.

### 14.4.1 SYSEX SEND

Here projects, patterns, and Sounds can be sent to an external device via the MIDI OUT port or the USB port of the Digitone.



The column to the left selects what will be backed up. Select the column using the [LEFT] arrow key. Use the [UP]/[DOWN] keys or the *TRACK LEVEL* knob to navigate in the column. The SysEx data send alternatives located in the column to the right will change depending on the selection made in the left column. Press the [RIGHT] arrow key to access this column. Use the [UP]/[DOWN] keys or the *TRACK LEVEL* knob to select what will be sent. Press [YES] to initiate the SysEx send procedure.

**PROJECT** will send the active project (settings, patterns, Sounds in the Sound Pool) to the receiving device.

**PATTERN** will send the selected pattern to the receiving device.

**SOUNDS** will send the selected Sound bank to the receiving device.



- Backing up your data regularly is important!
- Before initiating a SysEx send, first, make sure the receiving device is listening for data to be sent.

### 14.4.2 SYSEX RECEIVE

Here projects, patterns, and Sounds can be received from an external device via the MIDI IN port or the USB port of the Digitone.



The column to the left selects what will be received. Select the column using the [LEFT] arrow key. Use the [UP]/[DOWN] keys or the **TRACK LEVEL** knob to navigate in the column. The SysEx data receive alternatives located in the column to the right will change depending on the selection made in the left column. Press the [RIGHT] arrow key to access this column. Use the [UP]/[DOWN] keys or the **TRACK LEVEL** knob to select what will be received. Press [YES] to initiate the SysEx receive procedure. The Digitone starts listening to incoming data. Press [NO] to stop listening.

**ANYTHING** listens to and receives any viable SysEx data (patterns, settings, Sounds).

**PATTERN** stores a received pattern to the selected pattern slot.

**SOUNDS** stores a received Sound to the selected slot in the +Drive Sound library. The option ANY-WHERE will place the Sound in the first free slot available. You can see the amount of free slots to the right of the bank indication.

### 14.5 SYSTEM

The System menu contains USB CONFIG, OS UPGRADE and FORMAT +DRIVE options for the Digitone.



#### 14.5.1 USB CONFIG

To use the Digitone as an Overbridge device you must set it to Overbridge mode. Do so by selecting the OVERBRIDGE MODE menu item and ticking the box by pressing [YES]. For more information, please see "6.6 OVERBRIDGE" on page 18.

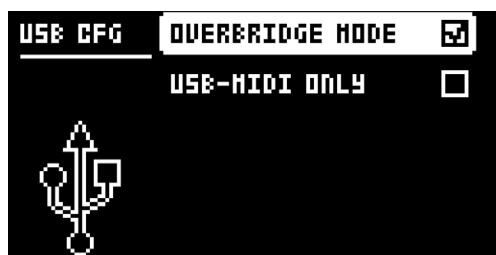

Select USB-MIDI ONLY and press [YES] if you wish to disable the Overbridge functionality.

#### 14.5.2 OS UPGRADE

Use this menu option when you want to upgrade the Digitone OS. Use our free Elektron Transfer software to send the OS syx file. You can download the Elektron Transfer software and the OS syx file from the Elektron website.

You must connect the device you use to send the OS syx file to either the MIDI IN or USB port of Digitone for the transfer to be possible.

Please note that the Digitone does not appear as an icon on your computer desktop.



1. Press **[YES]** to make Digitone start listening for incoming OS SysEx data. If you wish to cancel the waiting state, press **[NO]**.



2. Open Elektron Transfer and select Elektron Digitone for MIDI Input device as well as MIDI Output device.
3. Drag and drop the syx file to the Elektron Transfer main window to send it to the Digitone.

A progress bar is visible on the Digitone screen when receiving the OS. When the process is completed, the OS is updated, and the unit reboots.



If the Digitone is receiving the OS upgrade through the MIDI ports, use the Elektron TM-1 USB MIDI interface for up to 10x transfer speeds.

#### 14.5.3 FORMAT +DRIVE

You can delete all content of the +Drive. Use the **[LEFT]** or **[RIGHT]** arrow keys to select what content you wish to delete and press **[YES]** to confirm. A prompt appears asking if you want to execute the formatting procedure. Press **[YES]** to proceed with the formatting.



**PROJECTS+SOUNDS** erases all projects and sounds. Press the **[LEFT]** or **[RIGHT]** arrow keys to tick/untick this box.

### 15. STARTUP MENU

---

Press and hold the [FUNC] key while powering up the Digitone to access the STARTUP menu. Here you can perform a variety of tasks. Press the corresponding [TRIG] key to choose the different alternatives.

#### 15.1 TEST MODE

Press the [TRIG 1] key to enter TEST mode.



For testing purposes, a short sound is sent through all outputs of the unit.

You can perform this self-test if you have any trouble with your Digitone and suspect it may be due to a hardware problem. Use the [UP] and [DOWN] keys to scroll through the test log. A fully functional device should not report any errors. Please contact Elektron support or the retailer that you bought your Digitone from if the device log reports an error.

#### 15.2 EMPTY RESET

Press the [TRIG 2] key to perform an empty reset. The reset erases all patterns and sounds, but the data on the +Drive remains intact.

#### 15.3 FACTORY RESET

Press the [TRIG 3] key to perform a factory reset. When you perform a factory reset on the Digitone, it overwrites and re-initializes the active RAM project (including all pattern and global data). The +Drive project slot 1 is overwritten and re-initialized with factory preset patterns, sounds, and settings. Sound bank A is overwritten with the factory sounds.

If you wish to keep the active project, remember to save it to a +Drive project slot higher than 1 before you perform a factory reset.

#### 15.4 OS UPGRADE

Press the [TRIG 4] key to initiate the OS upgrade. Digitone enters a waiting stage, and listens for incoming OS data, and "READY TO RECEIVE" is shown on the screen. You must connect the device you use to send the OS syx file to the MIDI IN port of Digitone for the transfer to be possible. Use our free C6 SysEx utility software to send the OS syx file. You can download the C6 SysEx utility software and the OS syx file from the Elektron website.



- You cannot use the Elektron Transfer software to transfer OS syx files when you are in the STARTUP menu.
- USB MIDI transfer is not possible when you want to upgrade the OS from the STARTUP menu.

On your computer, download the OS syx file, open the C6 software. Click CONFIGURE and select Digitone for MIDI In as well as MIDI Out. Drag the syx file to the C6 main window, then highlight it by clicking on it with the mouse pointer. Click the "send" button in the top left corner of the C6 window.

A progress bar shows the progress of the OS upgrade. The message "UPGRADING... DO NOT TURN OFF" appears when the transfer is finished. Please note that the upgrade takes a little while. The device restarts when the upgrade process is finished.



When you send the OS syx file, use our free Elektron C6 software. You can download it from the Elektron website.

#### 15.5 EXIT

Press the [TRIG 5] key to exit the STARTUP menu.

## 16. SETUP EXAMPLES

The Digitone likes to play with other machines. Whether it uses its ability to sync and play with legacy machines, is paired with the Digitone or controls other synthesizers.

### 16.1 DIGITONE WITH A MONOPHONIC BASS MACHINE

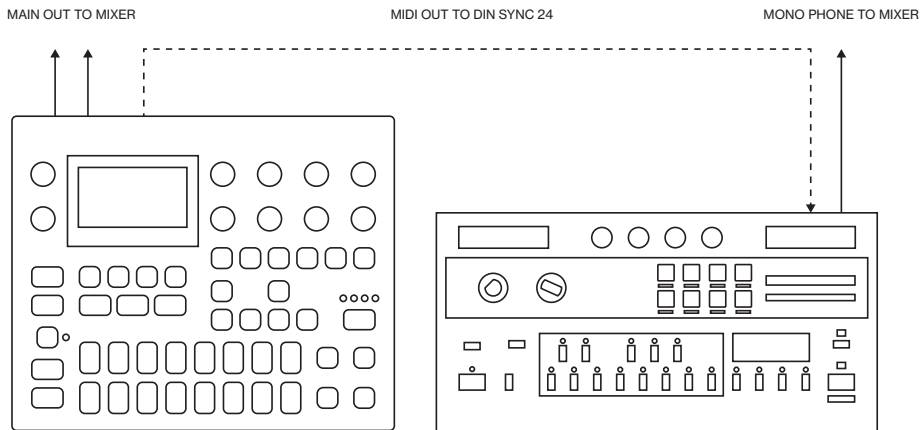

The DIN sync capabilities of the Digitone allows you to use gear from yesteryear.

In this example, a legacy monophonic bass machine is used alongside the Digitone. The Digitone can stop, start and control the tempo of the bass machine.

1. Prepare a bassline pattern on the bass machine.
2. Connect the output of the bass machine to the mixer using a Mono jack 6.3 mm male cable.
3. Connect the Digitone audio outputs to the mixer using 2 x Mono or Stereo jack 6.3 mm male cables.
4. Use a DIN connector cable to connect the MIDI OUT of the Digitone to the SYNC IN of the bass machine.
5. On the Digitone, press **[GLOBAL SETTINGS]**, and then navigate to **MIDI CONFIG > PORT CONFIG** and set **OUT PORT CONFIG** to **DIN24**.

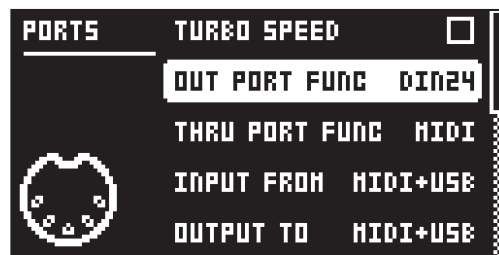

6. Press **[PLAY]** on the Digitone.

### 16.2 DIGITONE TOGETHER WITH THE DIGITAKT

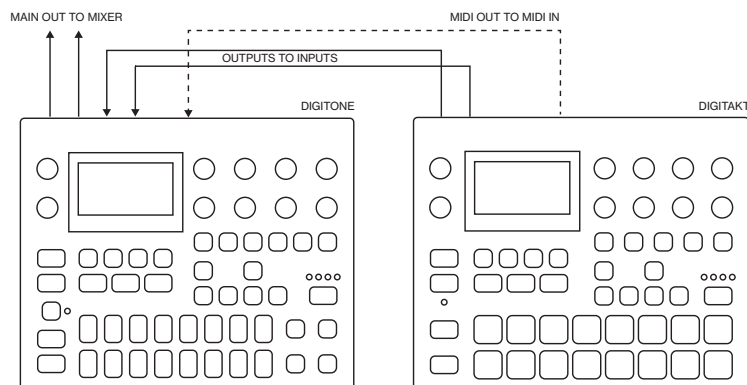

Digitone works very well together with the Digitakt, and you can, for example, route the audio from the Digitakt through the Digitone and sync the tempo of the sequencers.

1. Use a standard MIDI cable to connect the Digitakt MIDI OUT jack with the Digitone's MIDI IN jack.
2. Use two TR or TRS cables to connect the OUTPUT L/R from the Digitakt to the INPUT L/R on the Digitone.
3. On the Digitakt, press **[GLOBAL SETTINGS]**, and then navigate to MIDI CONFIG > PORT CONFIG and set **OUT PORT FUNC** to MIDI.
4. In the same menu set **OUTPUT TO** to MIDI.
5. Press **[GLOBAL SETTINGS]**, and then navigate to MIDI CONFIG > SYNC and set **CLOCK SEND** to ON.
6. On the Digitone, press **[GLOBAL SETTINGS]**, and then navigate to MIDI CONFIG > PORT CONFIG and set **INPUT FROM** to MIDI.
7. Press **[GLOBAL SETTINGS]**, and then navigate to MIDI CONFIG > SYNC and set **CLOCK RECEIVE** to ON.
8. Press **[PLAY]** on the Digitakt
9. On the Digitone, press **[FUNC] + [LFO]** to open the MASTER page.
10. Adjust the **IN L/R** to set the level of the incoming audio from the Digitakt.
11. Set **LPAN** to L64 and **RPAN** to R63.
12. Adjust the **CHR**, **DEL** and **REV** parameters to add the Digitone's send effects to the Digitakt's audio.



### 16.3 CONTROLLING A SYNTHESIZER USING THE MIDI TRACKS

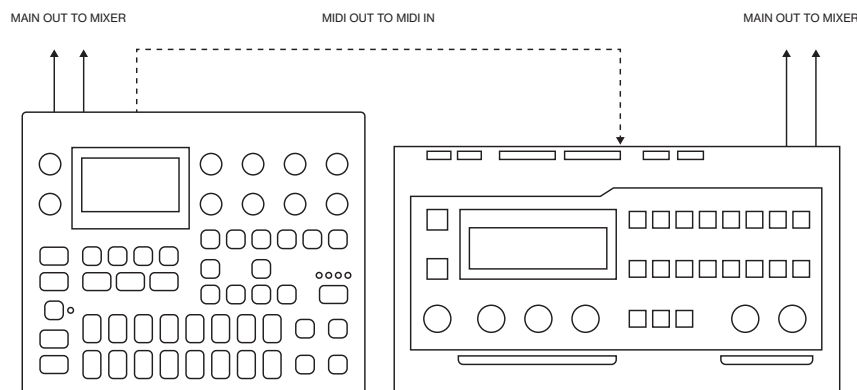

Digitone has extensive capabilities to use its sequencer's MIDI tracks to control other MIDI-equipped synthesizers.

1. Use a standard MIDI cable to connect the Digitone MIDI OUT jack with the synthesizer's MIDI IN jack.
2. On the Digitone, press **[GLOBAL SETTINGS]**, and then navigate to MIDI CONFIG > PORT CONFIG and set **OUT PORT FUNC** to MIDI.
3. In the same menu set **OUTPUT TO** to MIDI.

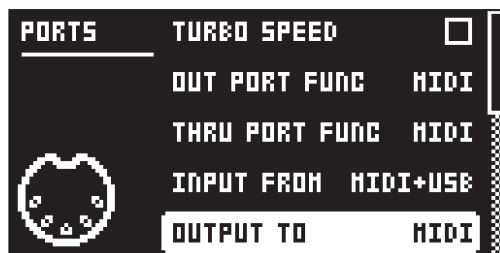

4. On the main screen, press **[MIDI]** and then **[TRIG 1-4]** to select a MIDI track.
5. Press **[SYN1]** and use the **CHAN** parameter to select a MIDI channel for the tracks output data.
6. Make sure to set your synthesizer to receive MIDI input in a way that corresponds to the settings you made in the Digitone.

You are now ready to use the Digitone sequencer to control your synthesizer. For more information about using the Digitone sequencer, please see "10. THE SEQUENCER" on page 27.

## 17. USEFUL KEY COMBINATIONS

---

Use the key combinations below to speed up your workflow.

### GENERAL

[FUNC] + [REC] performs a copy command. The action depends on the currently active page or mode.

[FUNC] + [PLAY] performs a clear command. The action depends on the currently active page or mode.

[FUNC] + [STOP] performs a paste command. The action depends on the copied content.

### TRACK/BANK/PATTERN SELECT

[TRACK 1–4] keys to select a synth track.

[MIDI] and then [TRACK 1–4] keys to select a MIDI track.

[BANK] + [TRIG 9-16] keys to select a bank.

[PTN] + [TRIG 1-16] keys to select a pattern.

### NAMING

[FUNC] + [ARROW] (on the NAMING screen) to choose a letter.

[FUNC] + [NO] (on the NAMING screen) to erase a letter.

### SAVING AND RELOADING

[FUNC] + [GLOBAL SETTINGS] saves the active project.

[FUNC] + [YES] temporary saves the active pattern.

[FUNC] + [NO] reloads the active pattern from temporary save.

### MENU ACCESS

[FUNC] + [PATTERN MENU] opens the IMPORT/EXPORT menu.

[FUNC] + [TRIG PARAMETERS] opens the SOUND SETUP menu.

[FUNC] + [SYN1] opens the ARPEGGIATOR menu.

[FUNC] + [SYN2] opens the CHORUS menu.

[FUNC] + [FLTR] opens the DELAY menu.

[FUNC] + [AMP] opens the REVERB menu.

[FUNC] + [LFO] opens the MASTER menu.

[FUNC] + [PTN] opens the METRONOME menu.

[FUNC] + [PAGE] opens the pattern/track SCALE menu.

[FUNC] + [MIDI] opens the MIDI CONFIG menu.

### SEQUENCER SETTINGS

[FUNC] + [TEMPO] to tap tempo.

[FUNC] + [LEFT/RIGHT] to nudge tempo (when sequencer is playing).

[FUNC] + [LEFT/RIGHT] moves all trigs a whole step, left or right (when in GRID RECORDING mode).

[TRIG] key (hold) + [LEFT/RIGHT], opens the MICRO TIMING menu and sets the micro timing for the trig (when in GRID RECORDING mode).

### SEQUENCER RECORDING

[RECORD] + [PLAY] starts LIVE RECORDING.

[RECORD] + double-tap [PLAY] activates/deactivates QUANTIZE LIVE RECORDING.

[NO] + [TRACK 1–4] keys during LIVE RECORDING clears the trigs from a sequencer track.

[FUNC] + [PTN] (long press) toggles the metronome on/off.

[FUNC] + [TRIG] adds lock trigs (when in GRID RECORDING mode).

## MUTES

[FUNC] + [TRACK 1–4] keys mutes/unmutes one or several tracks.

## UNISON

[FUNC] + [VOICE] toggles unison on/off. [VOICE] blinks if unison is not possible due to locked voices on other tracks.

## MODES

[FUNC] + [BANK] enters MUTE mode.

[FUNC] + double-press [BANK] toggles between PATTERN MUTE mode and GLOBAL MUTE mode.

[YES] + [PAGE] activates FILL mode for one pattern cycle.

Press and hold [PAGE] to activate FILL Mode for as long as [PAGE] is held.

Press and hold [PAGE] + [YES], and then release [PAGE] before you release [YES] to latch FILL mode. Press [PAGE] again to unlatch FILL mode.

## CLEAR TRACK/CLEAR PATTERN

[FUNC] + [PLAY] (while in GRID RECORDING mode) clears active track.

[FUNC] + [PLAY] (while in no mode or LIVE RECORDING mode) clears pattern.

## RESET PARAMETERS

Press *DATA ENTRY* knob + [NO] to reset the parameter to the default value.

[PARAMETER] key + [PLAY] to reset all the parameters in the selected parameter page to default values.

## ARPEGGIATOR

[FUNC] + [TRACK NOTE] toggles the arpeggiator on/off.

[FUNC] + [SYN1] opens the ARPEGGIATOR menu.

## 18. TECHNICAL INFORMATION

---

### ELECTRICAL SPECIFICATIONS

**Impedance balanced audio outputs**  
Main outputs level: +22 dBu  
Output impedance: 440  $\Omega$  unbalanced  
Digital-to-analog S/N ratio: 108 dB (20–20.000 Hz)

**Headphones output**  
Headphones out level: +22 dBu  
Output impedance: 55  $\Omega$

**Audio inputs**  
Input level: +19 dBu  
Audio input impedance: 11 k $\Omega$   
Analog-to-digital S/N ratio: 112 dB (20–20.000 Hz)

Unit power consumption: 7 W typical  
Compatible Elektron power supply: PSU-3b

### HARDWARE

128 × 64 pixel OLED screen  
MIDI In/Out/Thru with DIN Sync out  
2 × 1/4" impedance balanced audio out jacks  
2 × 1/4" audio in jacks  
1 × 1/4" stereo headphone jack  
48 kHz, 24-bit D/A and A/D converters  
Electrically isolated Hi-Speed USB 2.0 port  
Power inlet: Center positive 5.5 × 2.5 mm barrel jack, 12 V DC, 1 A

### PHYSICAL SPECIFICATIONS

Sturdy steel casing  
Dimensions: W215 × D176 × H63 mm  
(8.5" × 6.9" × 2.5") (including knobs and feet)  
Weight: approximately 1.49 kg (3.3 lbs)  
100 × 100 mm VESA mounting holes. Use M4 screws with a max length of 7 mm.  
Maximum recommended ambient operating temperature: +40 °C (+104 °F)

## 19. CREDITS AND CONTACT INFORMATION

---

### CREDITS

#### PRODUCT DESIGN AND DEVELOPMENT

Oscar Albinsson  
Johannes Algelind  
Ali Alper Çakır  
Magnus Forsell  
Anders Gärder  
Andreas Henriksson  
Simon Mattisson  
Jimmy Myhrman  
Jon Mårtensson  
Viktor Nilsson  
Olle Petersson  
David Revelj  
Mattias Rickardsson  
Martin Sigby

#### ADDITIONAL DESIGN

Ufuk Demir  
Thomas Ekelund

#### DOCUMENTATION

Erik Ångman

#### PRESET SOUND DESIGN

Johannes Algelind  
Blush Response (Joey Gonzalez)  
Palle Dahlstedt  
Dataline (Cenk Sayınlı)  
Divkid (Ben Wilson)  
Mark Fell

Hizmi  
Toru Koda  
Simon Mattisson  
Jimmy Myhrman  
Zabutom (Niklas Sjösvärd)  
Erik Ångman

### CONTACT INFORMATION

#### ELEKTRON WEBSITE

<http://www.elektron.se>

#### OFFICE ADDRESS

Elektron Music Machines MAV AB  
Sockerbruket 9  
SE-414 51 Gothenburg  
Sweden

#### TELEPHONE

+46 (0)31 743 744 0



## APPENDIX A: THE DIGITONE FM SYNTHESIS

### A.1 OVERVIEW

At its core, the Digitone is a four operator Frequency Modulation (FM) synth in the style of the classic 80s implementations. However, unlike the early FM synths, the Digitone use its FM engine more like a complex tone generator than a complete synthesizer voice (although it does have this capability too). The Digitone signal path is more similar to a typical subtractive synth than a classic FM voice.

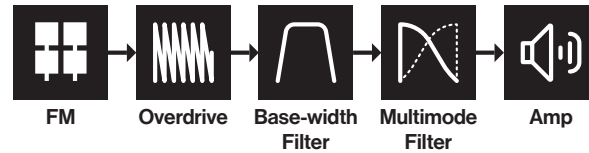

The idea of this design is to harness the raw, and often complex, soundscapes of FM synthesis and use a more well-known and approachable subtractive method for the overall sound shaping.

FM is a synthesis method where you add harmonics to the timbre by using modulation or layering to shape the sound. You add harmonics by modulating one oscillator's pitch with the output of another oscillator. FM works similarly to how you would apply vibrato via an LFO. At slower modulation rates, it is simply vibrato, but when the modulating frequency reaches audio rate, the vibrato effects becomes a part of the sound and becomes a timbral effect instead.

### A.2 THE OPERATORS

In FM synthesis the oscillators are called operators. Unlike the analog oscillator, the operator also contains an envelope and specific input and outputs, making it a sort of macro oscillator. FM combines two or more operators to generate a more harmonically rich output. An operator that is used to modulate another operator is called a modulator. The operator that generates, or carries, the resulting tone is called a carrier.

Feedback is used to increase the sharpness of a sound. Feedback is only applied to modulators. The output of the operator is fed back into itself, resulting in added harmonics. In Digitone, an operator with feedback with a parameter value around 35 results in a sawtooth waveform. If pushed to higher values, the feedback soon results in noise. For more information, please see "11.3.7 FDBK" on page 40.

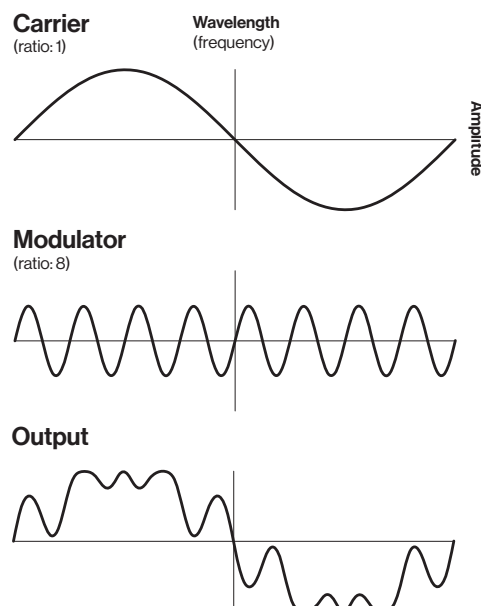
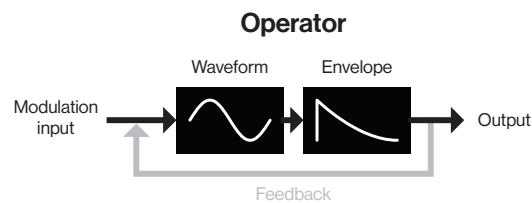

In some instances, an operator can be both carrier and modulator. This means that it outputs its result as a tone while also using it to modulate another operator. We have divided the operators into three groups: **C**, **A**, and **B** (B1 and B2) to lessen the complexity and make the Digitone easier to use. Since group **B** consist of two operators, the parameter controls for **B** are macro mapped to both operators.

### A.3 ALGORITHMS

An algorithm is a set routing, or combination, of the operators. Routing the modulation in different ways gives you several different methods of applying modulation and naturally different results.

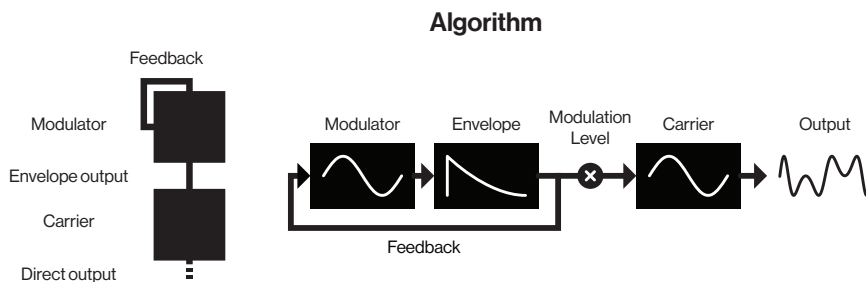

Pictured above is a 2 operator algorithm, which is FM synthesis in its most basic form. The Digitone has four operators available which can be routed in many different ways. Different algorithms dramatically changes the characteristics of the output - for example stacking four operators can lead to very complex timbres.

The Digitone has eight different algorithms where the four operators are routed in different ways. For more information, please see “11.3.1 ALGO” on page 40. Each algorithm has two carrier outputs (X and Y) that come from two different operators depending on what algorithm you chose. It is possible to use the **MIX** parameter to mix between these outputs so that you can cross-fade between two separate timbres. For more information, please see “11.3.8 MIX” on page 40.

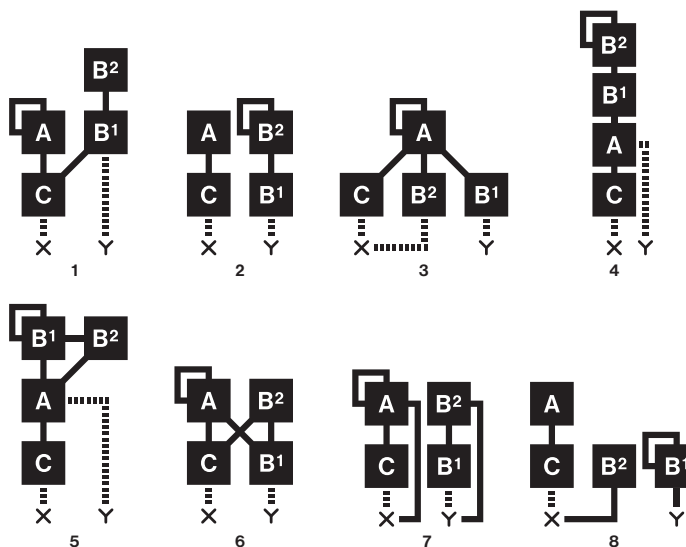

The lines going to X and Y indicate the output from a carrier. There are two different ways a carrier output is sent to the X/Y outputs: 1. Its amplitude is unaffected by the operator envelope (dotted line). 2. Its amplitude is affected by the operator envelope (filled line). The sound from the X/Y outputs is then routed via the overdrive to the filters.

### A.4 FM RATIOS

Frequency modulation is applied in multipliers of the principal frequency to retain the sounds tonality. These multipliers are known as ratios. Each operator group’s ratio is a multiplier of the input pitch (note value). The higher the ratio, the higher the pitch frequency. For example, when applying modulation with a ratio of 1:2 (carrier:modulator), the carrier output resembles a square wave. A ratio of 1:1 sounds like a sawtooth, and odd numbers can be used for various metallic or other “natural” sounds. In Digitone, the FM ratios for the different operator groups works like this:

**C** which always works like a carrier, is limited mostly to integers since it is generally used for carrying the base note of the sound. For more information, please see “11.3.2 RATIO C” on page 40.

**A** has a more extensive number of ratio values to allow for more inharmonic relationships. For more information, please see “11.3.3 RATIO A” on page 40.

**B** (B1 and B2) controls both operators at the same time. The minimum value for B1 and B2 is .25. As you turn the encoder, B2 increases until it reaches the max (16). It then starts over from .25 and B1 increases to the next value (0.5). This revolving behavior continues until both operators reach the maximum value. This parameter behavior is similar to the movement of the hands on a watch. For more information, please see “11.3.4 RATIO B” on page 40.

### A.5 THE OPERATOR ENVELOPES

If you modulate one oscillator directly with another it creates very harsh harmonics, so you need to limit the modulation level to control the amount of modulation. In Digitone you use an envelope and a LEVEL parameter control to attenuate the amount of how much the modulator affects the carrier. The envelopes also give the possibility to control the modulation over time. A piano for example, when first struck, the timbre is sharp but quickly fades to a softer tone. Envelopes and modulation level are vital elements in FM synthesis and are the tools that you use to shape the sounds you want to achieve.

The Digitone FM engine has two operator envelopes that are designed to be practical and easy to use. One envelope is for operator group A, and one is for group B (B1 and B2).

The envelopes are essentially expanded AD (Attack Decay) envelopes, but with an added adjustable end level (the amplitude level the sound reaches at the end of the decay stage). Normally, an AD envelope always ends at zero level, but with FM you often want to retain some modulation after a short pluck or fade in for example. For more information, please see “11.4 SYN 2 PAGE 1” on page 40.



Please note that operator envelope B controls the output from both B1 and B2.

The envelopes can be either triggered or gated - making it either an ADE (Attack Decay End) or an ASDE (Attack Sustain Decay End) envelope. The sustain phase does not have an envelope level. It is instead the LEV parameter that sets the sustain level. The note length defines the length of the sustain phase. For more information, please see “11.5.2 ATRG” on page 42.

#### Triggered (ATRG/BTRG ON)

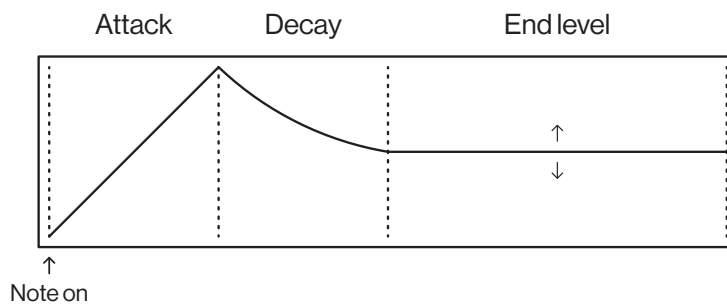

#### Gated (ATRG/BTRG OFF)

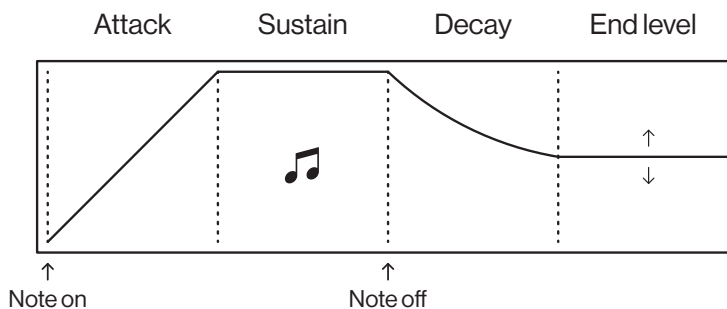

You can also set if the envelopes should reset or not when they are retriggered. For more information, please see "11.5.3 ARST" on page 42.

**Reset on (ARST/BRST ON)**

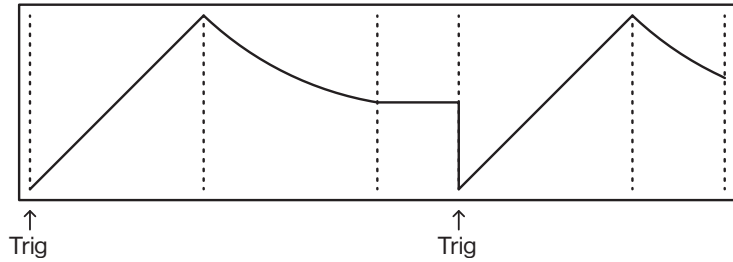

**Reset off (ARST/BRST OFF)**

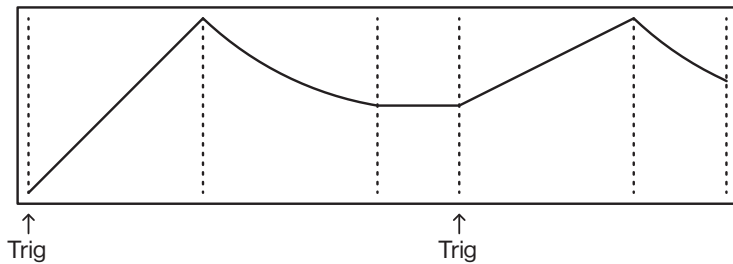

The **LEVEL** parameters on the SYN2 page controls the amount of modulation from the A and B operators. For more information, please see "11.4.8 LEV B" on page 41. The **LEVEL** parameter for B is macro mapped to both operator B1 and B2 and control their modulation amount as per this graph:

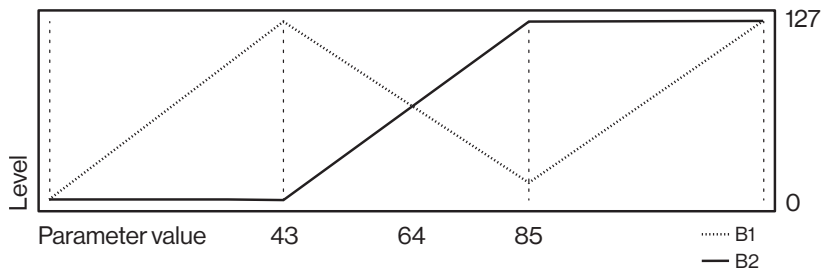

**A.6 HARMONICS**

The default output from an operator is a sine wave, but you can use the **HARM** parameter to add upper partials to some of the operators' sine waves to create more harmonically rich waveforms. The **HARM** parameter is bipolar. Negative parameter values change the harmonics of operator C, while positive parameter values change the harmonics of operators A and B1.

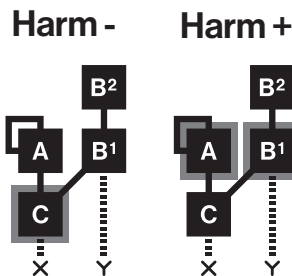

When changing harmonics, intermediate values interpolates between the current and the next harmonic. This interpolation works much like in wavetable synthesis, sweeping between the harmonics, smoothly transitioning from one timbre to another. For more information, please see "11.3.5 HARM" on page 40. The harmonic series for the operators looks like this:

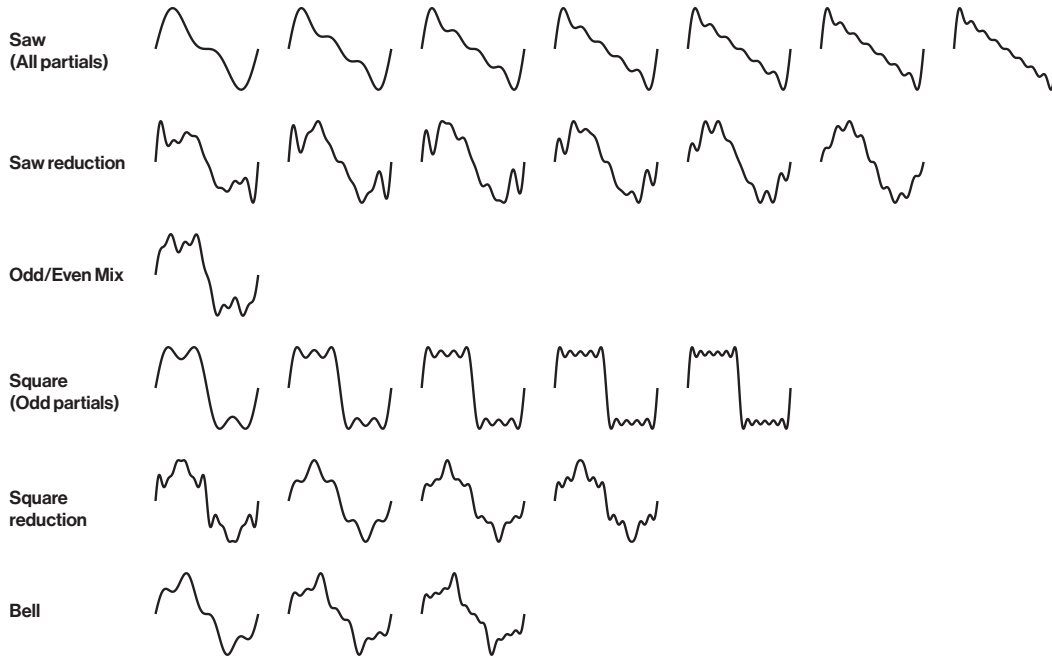

The Digitone uses a form of additive synthesis to create the harmonic series for the HARM parameter. Additive synthesis is one of the oldest forms of electronic sound generation. It is a quite simple form of synthesis but still very powerful. The basic principle is to add multiple sine waves together to form complex timbres. Each sine wave is called a partial. Typically, each part is one octave above the previous. You retain the frequency of the tone by keeping the partials spread across octaves. By attenuating each partial, the timbre changes its harmonic content, resulting in different waveforms.

The first partial is always kept at full volume, which keeps the base octave intact.

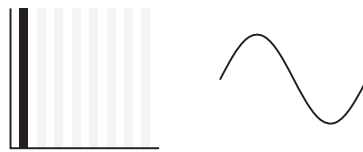

Adding every partial in series will replicate a sawtooth. Note how the volume decreases for each partial, creating a natural falloff.

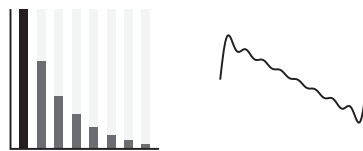

Adding every odd partial in series will approximate a square wave.



The additive method can be used to make many different timbres. This combination of partials, for example, sounds close to a bell tone.



### A.7 SYN1 PAGE 1 PARAMETERS OVERVIEW

Here is a graphical overview of what part of the FM engine the parameters on the SYN1 pages affects. The affected part of the FM engine is highlighted with grey. For more information, please see “11.3 SYN1 PAGE 1” on page 39.

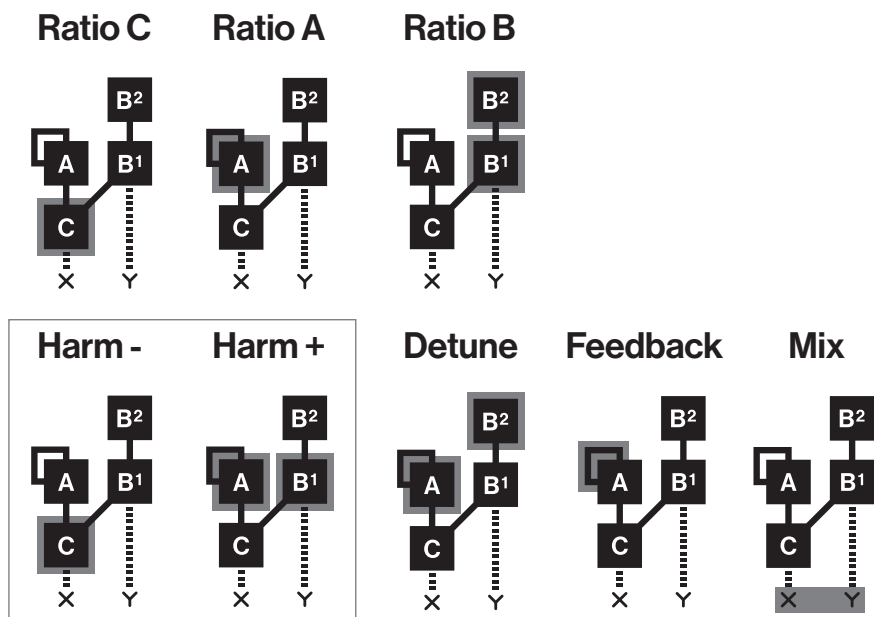

## APPENDIX B: MIDI IMPLEMENTATION

This appendix lists the CC and NRPN specifications for the Digitone.

### B.1 TRACK PARAMETERS

TRACK				
Parameter	CC MSB	CC LSB	NRPN MSB	NRPN LSB
Mute	94		1	101
Track level	95		1	100

### B.2 TRIG PARAMETERS

TRIG PARAMETERS				
Parameter	CC MSB	CC LSB	NRPN MSB	NRPN LSB
Root	3		3	0
Velocity	4		3	1
Length	5		3	2
Filter Trig	13		3	5
LFO Trig	14		3	6

### B.3 FM PARAMETERS

SYN1				
Parameter	CC MSB	CC LSB	NRPN MSB	NRPN LSB
Algorithm	90		1	72
Ratio C	91		1	73
Ratio A	92		1	74
Ratio B	16	48	1	75
Harmonics	17	49	1	76
Detune	18	50	1	77
Feedback	19	51	1	78
Mix	20	52	1	79

SYN2				
Parameter	CC MSB	CC LSB	NRPN MSB	NRPN LSB
A Env Attack	75		1	80
A Env Decay	76		1	81
A Env End	77		1	82
A Level	78		1	83
B Env Attack	79		1	84
B Env Decay	80		1	85
B Env End	81		1	86
B Level	82		1	87
A Delay	83		1	88
A Trig	84		1	89
A Env Reset	85		1	90
B Delay	86		1	91
B Trig	87		1	92

SYN2				
Parameter	CC MSB	CC LSB	NRPN MSB	NRPN LSB
B Env Reset	88		1	93
Phase Reset	89		1	94

### B.4 FILTER PARAMETERS

FILTER				
Parameter	CC MSB	CC LSB	NRPN MSB	NRPN LSB
Filter Frequency	23	55	1	20
Resonance	24	56	1	21
Filter Type	74		1	22
Attack Time	70		1	16
Decay Time	71		1	17
Sustain Level	72		1	18
Release Time	73		1	19
Env. Depth	25	57	1	23
Base	26	58	1	24
Width	27	59	1	25

### B.5 AMP PARAMETERS

AMP				
Parameter	CC MSB	CC LSB	NRPN MSB	NRPN LSB
Attack Time	104		1	32
Decay Time	105		1	33
Sustain Level	106		1	34
Release Time	107		1	35
Drive	9	41	1	36
Pan	10	42	1	37
Volume	7	39	1	38
Chorus Send	12	44	1	41
Delay Send	13	45	1	40
Reverb Send	14	46	1	39
Amp Env Reset	102		1	42

### B.6 LFO PARAMETERS

LFO				
Parameter	CC MSB	CC LSB	NRPN MSB	NRPN LSB
Speed LFO1	28	60	1	48
Multiplier LFO1	108		1	49
Fade In/Out LFO1	109		1	50
Destination LFO1	110		1	51
Waveform LFO1	111		1	52
Start Phase LFO1	112		1	53
Trig Mode LFO1	113		1	54



LFO				
Parameter	CC MSB	CC LSB	NRPN MSB	NRPN LSB
Depth LFO1	29	61	1	55
Speed LFO2	30	62	1	57
Multiplier LFO2	114		1	58
Fade In/Out LFO2	115		1	59
Destination LFO2	116		1	60
Waveform LFO2	117		1	61
Start Phase LFO2	118		1	62
Trig Mode LFO2	119		1	63
Depth LFO2	31	63	1	64

## B.7 FX PARAMETERS

CHORUS				
Parameter	CC MSB	CC LSB	NRPN MSB	NRPN LSB
Depth	3	35	2	0
Speed	9	41	2	1
High-pass	70		2	2
Width	71		2	3
Delay Send	12	44	2	4
Reverb Send	13	45	2	5
Mix Volume	14		2	6

DELAY				
Parameter	CC MSB	CC LSB	NRPN MSB	NRPN LSB
Delay Time	15	47	2	10
Pingpong	16	48	2	11
Stereo Width	17	49	2	12
Feedback	18	50	2	13
Highpass Filter	72		2	14
Lowpass Filter	73		2	15
Reverb Send	19	51	2	16
Mix Volume	20		2	17

REVERB				
Parameter	CC MSB	CC LSB	NRPN MSB	NRPN LSB
Predelay	21	53	2	20
Decay Time	74		2	21
Shelving Freq	75		2	22
Shelving Gain	22	54	2	23
Highpass Filter	76		2	24
Lowpass Filter	77		2	25
Mix Volume	23		2	26

MASTER				
Parameter	CC MSB	CC LSB	NRPN MSB	NRPN LSB
Input L Volume	24	56	2	30
Input R Volume	25	57	2	32

**APPENDIX B: MIDI IMPLEMENTATION**

---

<b>MASTER</b>				
<b>Parameter</b>	<b>CC MSB</b>	<b>CC LSB</b>	<b>NRPN MSB</b>	<b>NRPN LSB</b>
Pan L	78		2	31
Pan R	79		2	33
Chorus Send	26	58	2	34
Delay Send	27	59	2	35
Reverb Send	28	60	2	36
Master Overdrive	29	61	2	37
Pattern Volume	95		2	38

---

**INDEX**

---

**+DRIVE 14, 23****A****AFTERTOUCHE 26**  
**ARPEGGIATOR 26****B****BREATH CONTROLLER 26****C****CHAINS 37**  
**CHORUS 53**  
**CHROMATIC MODE 21**  
**CONDITIONAL LOCKS 35**  
**CONNECTORS 12**  
**COPY, PASTE AND CLEAR 36**  
**CREDITS AND CONTACT INFORMATION 72****D****DATA STRUCTURE 14**Patterns 14  
Project 14  
Sounds 14**DELAY 53****F****FACTORY RESET 66****FILL MODE 36****FILTER 43****FM SYNTHESIS**Algorithms 74  
Carrier 73  
FM ratios 74  
Harmonics 76  
Modulator 73  
Operator envelopes 75  
Operators 73  
SYN1 Page 1 parameters overview 77**FX PARAMETERS 53**Chorus 53  
Delay 53  
Master 55  
Reverb 53, 55**G****GLOBAL SETTINGS 57**MIDI config 60  
Project 57  
System 64**GRID RECORDING MODE 28**Quick note method 29  
Track note method 28**K****KEY COMBINATIONS 70****KEY SCALING 24****L****LFO 46, 47, 51****LIVE RECORDING MODE 29****M****MICRO TIMING 30, 31****MIDI CONFIG 60****MIDI IMPLEMENTATION 79****MIDI TRACK PARAMETERS 49**Amp (CC select) 50  
Filter (CC value) 50  
LFO 51  
MIDI Source 49  
Trig 49**MOD WHEEL 25****MUTE MODE 21****N****NAMING SCREEN 17****O****OS UPGRADE 64****OVERBRIDGE 18**

USB config 64

**OVERDRIVE 45**

Master 56

**P****PANEL LAYOUT 10****PARAMETER LOCKS 34****PATTERNS**Grid recording mode 28  
Live recording mode 29  
Parameter locks 34  
Pattern control 27  
Selecting a pattern 27  
Tempo 27  
Trig Types 27**PATTERNS AND SOUNDS 23**Editing a sound 23  
Playing a sound 23  
Sound Browser 58  
Sound Manager 59**PITCH BEND 25****PROJECT MANAGER 57****PROJECTS 57**Load 57  
Project Manager 57  
Save 57

Write protection 57

## Q

**QUANTIZE 32**

**QUICK SCROLLING 17**

**QUICK START 19**

## R

**RECORDING MODES**

Grid recording mode 28

Grid recording using Quick Note method 29

Grid recording using Track Note method 28

Live recording mode 29

**REVERB 55**

## S

**SAFETY AND MAINTENANCE 3**

**SCALE 30**

**SCALE SETUP**

Length per pattern mode 33

Length per track mode 34

**SEQUENCER 27**

Conditional locks 35

Editing a pattern 27

Metronome 33

Micro timing 31

Parameter locks 34

Pattern control 27

Scale Menu 33

Selecting a pattern 27

Swing 36

Trig parameters page 30

**SETUP EXAMPLES 67**

Controlling a synthesizer using the MIDI tracks 68

Digitone together with the Digitakt 67

Digitone with a monophonic bass machine 67

**SOUND ARCHITECTURE 13**

**SOUND BROWSER 58**

**SOUND LOCKS 35**

**SOUND MANAGER 59**

**SOUND MENU 57**

**SOUNDS**

Clear Sound 60

Editing a Sound 23

Playing a Sound 23

Rename a Sound 60

Saving a Sound 24

Synth track parameters 39

**SOUND SETUP MENU 24**

Aftertouch 26

Breath controller 26

Filter keyscaling 25

Keyscaling 24

Mod wheel 25

Octave 25

Pitch bend 25

Pitch bend depth 25

Velocity mod 25

Velocity to vol 25

**STARTUP MENU 66**

**SWING 36**

**SYNTH TRACK PARAMETERS 39**

Amp 45

Filter 43

LFO 46

SYN 39

Trig 39

**SYSEX DUMP 63**

## T

**TECHNICAL INFORMATION 72**

**TEMPO 19**

**TEMPORARY SAVE AND RELOAD 37**

**TRACK NOTE MENU 30**

**TRANPOSE**

Direct pattern transpose 37

Direct track transpose 37

Transpose track 30

**TRIG PARAMETERS PAGE 30**

**TRIGS 27**

Lock trigs 27

Note trigs 27

Parameter locks 34

Sound lock 35

## U

**UNISON 31**

**USER INTERFACE 16**

## V

**VOICE MENU 30**

Layer 31

Locked voices 31

Unison 31

Unison Spread 31

Voice stealing 31



 **elekttron**