

# FILTeFACTORY™

THE ULTIMATE FILTER



English v1.1



The lightning flash with arrowhead symbol, within an equilateral triangle, is intended to alert the user to the presence of uninsulated dangerous voltage within the product's enclosure that may be of sufficient magnitude to constitute a risk of electric shock to persons.



The exclamation point within a equilateral triangle is intended to alert the user to the presence of important operating and maintenance (servicing) instruction in the literature accompanying the product.

## INSTRUCTIONS PERTAINING TO A RISK OF FIRE, ELECTRIC SHOCK, OR INJURY TO PERSON

# IMPORTANT SAFETY INSTRUCTIONS READ AND SAVE THESE INSTRUCTIONS

WARNING - When using electric products, basic precautions should always be followed, including the following:

1. Read all the instructions before using the product.
2. Do not use this product near water - for example near a bathtub, washbowl, kitchen sink, in a wet basement, or near a swimming pool, or the like.
3. This product should be used only with a cart or stand that is recommended by the manufacturer.
4. This product, either alone or in combination with an amplifier and headphones or speakers, may be capable of producing sound levels that could cause permanent hearing loss. Do not operate for long period of time at high volume level or at a level that is uncomfortable. If you experience any hearing loss or ringing in the ears, you should consult an audiologist.
5. The product should be located so that its location or position does not interfere with its proper ventilation.
6. The product should be located away from heat sources such as radiator, heat registers, or other products (including amplifiers) that produce heat.
7. Clean only with a damp cloth. Before cleaning the unit, turn off the power and unplug the power cord from the outlet.
8. The power supply cord of the product should be unplugged from the wall outlet during lightning storms or when left unused for a long periods of time.
9. Use only with attachments/accessories specified by the manufacturer.
10. The product should be serviced by qualified service personnel when:
  - A. The power supply cord or the plug has been damaged; or
  - B. Objects have fallen, or liquids has been spilled into the product; or
  - C. The product has been exposed to rain; or
  - D. The product does not appear to be operate normally or exhibits a marked change in performance; or
  - E. The product has been dropped, or the enclosure damaged.
11. Do not attempt to service the product beyond that described in the user maintenance instructions. All other servicing should be referred to qualified service personnel.

### For the USA

This product may be equipped with a polarized line plug ( one blade wider than the other). This is a safety feature. If you are unable to insert the plug into the outlet, contact an electrician to replace your obsolete outlet, Do not defeat the safety purpose of the plug.

### For Canada

For Polarized Line Plug:

**Caution:** TO PREVENT ELECTRIC SHOCK, MATCH WIDE BLADE OF PLUG TO WIDE SLOT, FULLY INSERT.  
**Attention:** POUR ...VITER LES CHOCES ...LECTRIQUES, INTRODUIRE LA LAME LA PLUS LARGE DE LA FICHE DANS LA BORNE CORRESPONDANTE DE LA PRISE ET POUSSER JASQU' AU FOND.

### For the U.K.

**IMPORTANT:** THE WIRES IN THIS MAINS LEAD ARE COLOURED IN ACCORDANCE WITH THE FOLLOWING CODE:

**BLUE: NEUTRAL**  
**BROWN: LIVE**

As the colours of the wires in the mains lead of this apparatus may not correspond with the coloured markings identifying the terminals in you plug, proceed as follows.  
 The wire which is coloured BLUE must be connected to the terminal which is marked with the letter N or coloured BLACK.  
 The wire which is coloured BROWN must be connected to the terminal which is marked with the letter L or coloured RED.  
 Under no circumstances must either of the above wires be connected to the earth terminal of the three pin plug.

**W**elcome to the world of Electrix. We would like to thank you for purchasing FilterFactory, The Ultimate Stereo Resonant Filter for musicians, DJs, producers and engineers. FilterFactory is unique in its ease of use and its focus on directly filtering a range of input signals from turntables to CD'S to Synths.

FilterFactory's digitally controlled Analog filters were modeled after VCF's (Voltage Controlled Filters) like those found in traditional Analog synthesizers. Use FilterFactory to re-mix your vinyl live. Just insert your FilterFactory between the turntable and the mixer and add your own filter sweeps, LFO's and distorted signals to the mix. FilterFactory has a built in phono pre-amp, so you can plug in your turntable directly. This setup allows you to cue the effect before it goes to the house by using the cueing feature of your mixer. In the studio full MIDI implementation makes FilterFactory the perfect recording tool. You can play the FilterFactory live and capture your performance in a sequence.

FilterFactory's unique future / retro case was designed to allow both desktop and rackmount installation. This concept makes FilterFactory's control surface perfect for live performance and studio use.

### ► **INSPECTION**

In your Electrix box you should find:

- **1 *Electrix FilterFactory***
- **1 *Manual***
- **1 *Rackmount kit***
- **1 *Warranty Card***
- **1 *EIC Power Cable (appropriate for your region)***

If this is not the case then please call your local Electrix distributor, agent or dealer.

# TABLE OF CONTENTS

<b>Introduction</b> .....	4
<b>Inspection</b> .....	4
<b>1 Quick Start</b> .....	6
<b>2 Understanding the Product</b>	
2.1 Front Panel .....	8
2.2 Back Panel .....	8
<b>3 Performance Guide</b>	
3.1 Setups: .....	12
3.2 Artist Applications .....	15
<b>4 MIDI Applications</b>	
4.1 Recording Performances to a Sequencer .....	17
4.2 MIDI Implementation Chart .....	18
<b>5 Specifications</b> .....	19
<b>6 Safety &amp; Conformity</b> .....	20
Français .....	23
Deutsch .....	43
Español .....	63

# 1. QUICK START

## 1.1 WHAT TO PLUG IN

*Here's the simplest way to get sound out of your Electrix FilterFactory:*

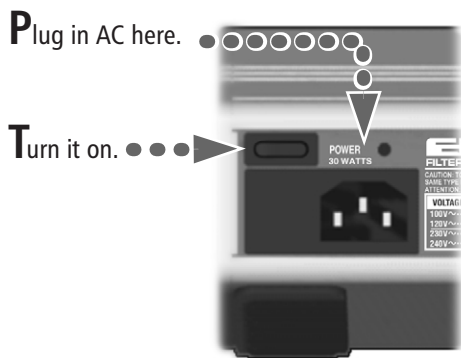
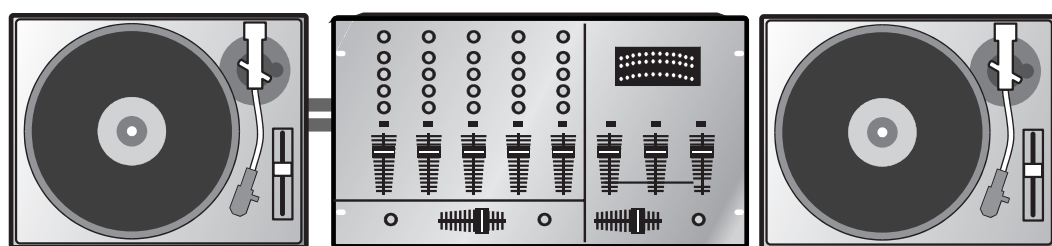

Use these line level outputs to connect to your mixer or power amplifier.

Turn on the phono pre-amp.

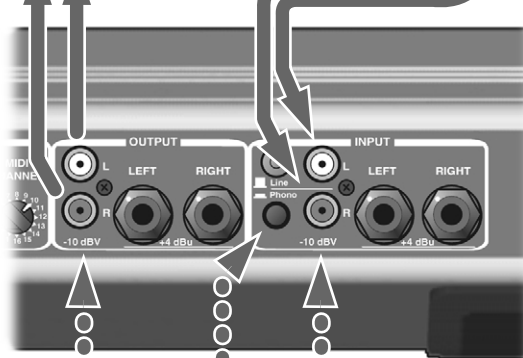

Plug in your turntable here.

**D**istortion level can be louder than the program level if desired.

**D**istortion Gain



**U**se the momentary button to play the effect. As you tap it, the effect will momentarily engage. When you engage an effect block, the momentary button switches its function and mutes the effect.

**O**verrides Tap Tempo

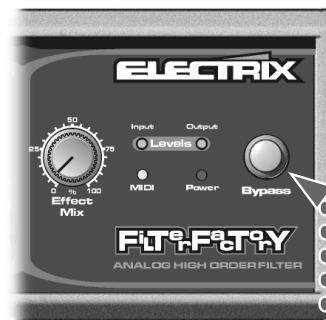

**G**lobal Bypass

**O**peration linked to Type setting. Low pass is the standard synth setting

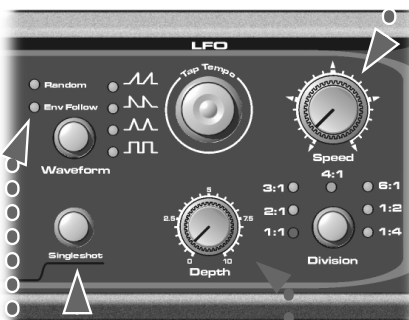

**W**hen engaged, the momentary triggers the filter mod for the number of cycles set by the division control.

**"E**nv Follow" adjusts filter frequency according to the dynamics of the input signal



**M**omentary control kicks in the filter unless the Single Shot control is engaged. When Single Shot is on, this button will trigger modulation.

**A**adjusts the amount of mod effect on the filter

**R**esonance peak control can go into self oscillation.

## 2. UNDERSTANDING THE PRODUCT

### 2.1 FRONT PANEL

**N**ote that there are no input or output controls. FilterFactory is set up to give you unity gain when bypassed or when the Mix control is at 0%. This means that signals running through it are not boosted or reduced in gain. If you are using a line level input (as opposed to a turntable) set the output of your source so that FilterFactory's Input Level LED doesn't go Red all that often. Try to keep your levels in the green which is the optimum level for FilterFactory.

- ▶ **Buzz** Buzz sets the amount of distortion. The more buzz, the more distortion you will have.

Buzz will take you from subtle, at the farthest left, to heavy distortion at the farthest right.

**NOTE:** Buzz will increase the level of your output signal substantially as you turn it up. Use the Trim control to get the level back to where you want it while the Buzz circuit is engaged.

- ▶ **Trim:** Sets the output level of the Buzz circuit. This can be set anywhere from inaudible to extremely loud. Use with caution.

- ▶ **Buzz Engage:** Toggles the buzz circuit in and out.

- ▶ **Buzz Momentary:** Temporarily engages the buzz circuit. This is useful for tapping patterns to create distortion hits and rhythms.

**Note:** When an effect is engaged, the Momentary will dis-engage it, when an effect is not engaged the momentary will engage it.

- ▶ **StereoFilter:** Frequency: Sets the resonant frequency of the stereo filter. Use it in conjunction with the resonance control. The more resonance you use the more distinct any changes you make with frequency will be. The frequency tuning range of the filter covers a 12 octave range from 10 Hz to 40 kHz. The External CV input can control this and has been adjusted to provide standard 1 Volt/Octave response.

- ▶ **Filter Type:** This control selects the basic sound of the filter. Each filter type has a unique sound. You will find situations where each one offers you a unique effect on a given signal.

**The High Pass** will roll off the bass of your signal. It will make things sound thinner. (See Fig. 1)

**The Band Pass** filter acts like Wah pedal and puts a peak in the middle of your signal. (See Fig. 2) This is great for highlighting certain frequency ranges or for creating a sweeping sound with the frequency knob.

**The Notch Filter** works the exact opposite of the Band Pass filter. It puts a notch in your signal, essentially killing a small frequency band. This effect often sounds like talking through a pipe. It will also create unique sweeping sounds, (that is similar to a phase shifter) when used in conjunction with the frequency knob. For best Notch result put the Resonance knob fully counter-clockwise.

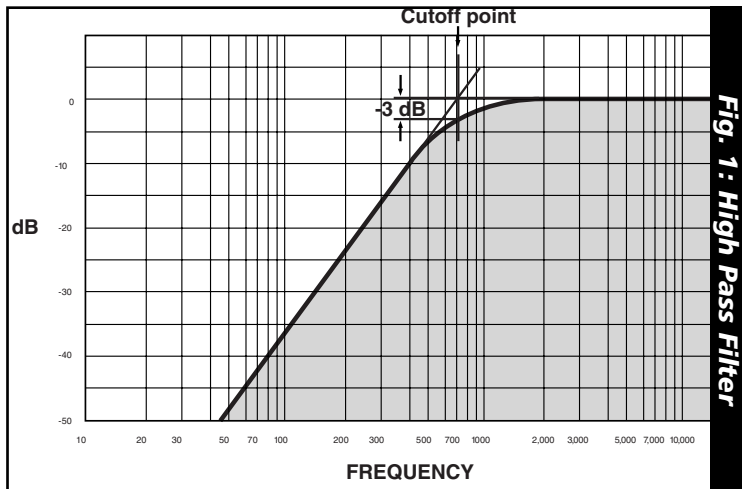

Fig. 1: High Pass Filter

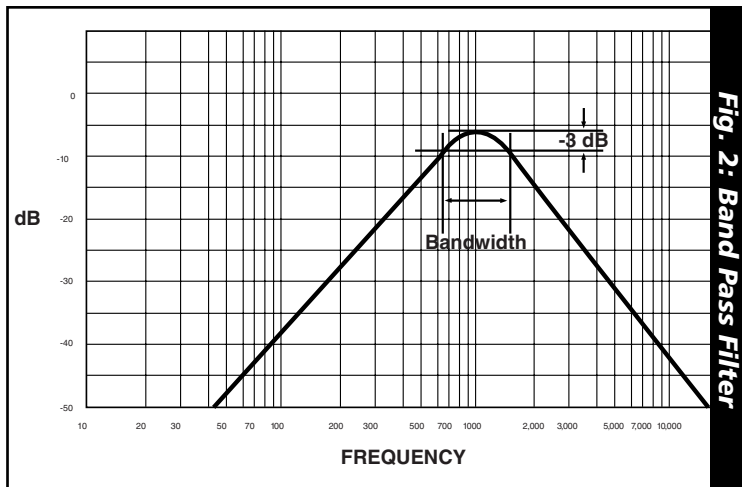

Fig. 2: Band Pass Filter

## 2.1 FRONT PANEL

The **Low Pass Filter** is the most commonly used filter type. This is the kind of filter you will find on vintage synths and envelope followers. It is useful for controlling the amount of harmonics or the brightness of a signal. As you sweep the frequency control, try adding some resonance to make the cutoff frequency more audible.

▶ **Filter Engage:** This control toggles the filter on and off. Turning this on restarts the LFO or triggers it if it is in single shot mode.

▶ **Filter Momentary:** This switch temporarily engages the stereo filter. Try using it to tap rhythmic patterns while adjusting the frequency knob. Pressing this button also restarts the LFO.

▶ **Resonance:** This controls the level of the peak at the resonant frequency of the filter, i.e. the frequency you dialed in with the frequency knob. FilterFactory was designed to create extreme effects, so be careful because the resonance control is able to cause the filters to self-oscillate at higher settings. Self oscillation produces a loud tone at the resonant frequency. It sounds a lot like sustained feedback.

▶ **4 Pole Mono:** The FilterFactory operates in a Stereo 2 Pole filter per channel mode, ( unless you switch to 4 Pole mode). When in Four Pole mode, the FilterFactory switches into Mono operation by summing the left and right channels before the 4 pole filter. A two pole filter will give you a gentler response, in technical terms it is defined as a 12dB/octave filter. A 4 pole or 24dB/octave filter will give you a much steeper filter response that will sound more pronounced.

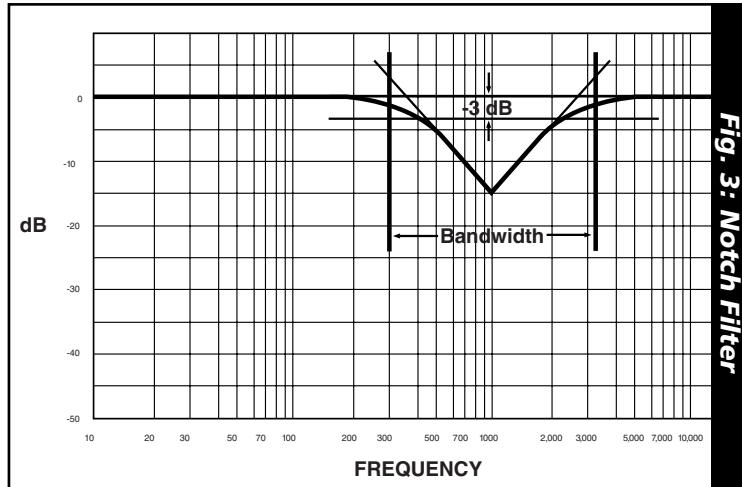

Fig. 3: Notch Filter

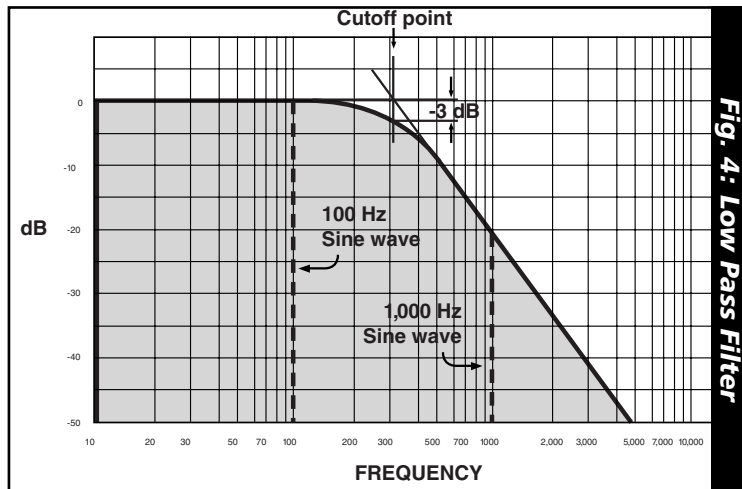

Fig. 4: Low Pass Filter





### LFO

- ▶ **Waveform:** The LFO provides the following cyclic (or repetitive) waveforms: Sawtooth, Inverse Sawtooth, Triangle, Square Wave, Envelope Follow and Random. If you increase the LFO depth and turn the LFO speed up a bit you will be able to hear their effect on your frequency setting.

**Note:** Although ENV Follow isn't a waveform we put it here anyway. To get it working, select ENV Follow, set the frequency down to 115Hz, on a Low Pass Filter, set your resonance to 7.5 and adjust the LFO depth to taste.

- ▶ **Singleshot:** This button changes how the Filter and the LFO Sections on your FilterFactory. Singleshot gives you the ability to trigger Filter Effects in a similar way that playing a note on an old synthesizer will trigger VCF and VCA Envelopes. The FilterFactory Singleshot Envelopes are borrowed from the LFO section. When single shot is on, Triangle, Sawtooth, and Inverse Sawtooth all become triggerable envelopes. The Division button allows you to select how many time the waveform envelope will trigger. LFO Speed adjusts the duration of the envelope, and the Filter Momentary triggers the envelope.

**Note:** Singleshot does not work when the ENV Follower is selected.

**Note 2:** If the Filter is not engaged, the Singleshot does not automatically finish the waveform.

- ▶ **Tap Tempo:** The tap tempo button is another way to control the LFO rate to match the beat of your music. When it is hit one time, it will restart the LFO at the beginning of its waveform. If it is hit twice within 2 seconds, then the time between presses is used as the new rate or tempo. If it is hit 3 or more times, it will average the time between presses to come up with a more accurate tempo.
- ▶ **Depth:** This controls the amount the LFO changes the filter frequency.
- ▶ **Speed:** LFO Speed controls the period of the LFO waveforms by changing the frequency of the LFO. The LFO Frequency range covers 0.1 Hz to 100 Hz for subtle to extreme effects.
- ▶ **Division:** The LFO rate, as defined by Tap Tempo or MIDI clock can be divided (or doubled) using this control. The actual rate is indicated by the flashing tempo LED.

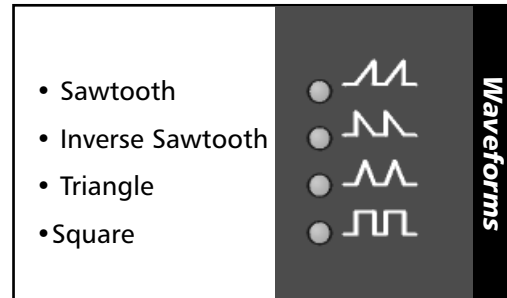

### GLOBAL

- ▶ **Effect Mix:** Controls the Mix of the Buzz and Filter Sections in relation to your dry signal. 0% is all dry, or the same as bypassing the FilterFactory. 100% will be all FilterFactory and none of your dry signal.
- ▶ **Bypass:** Bypasses both effect blocks.

## 2.3 BACK PANEL

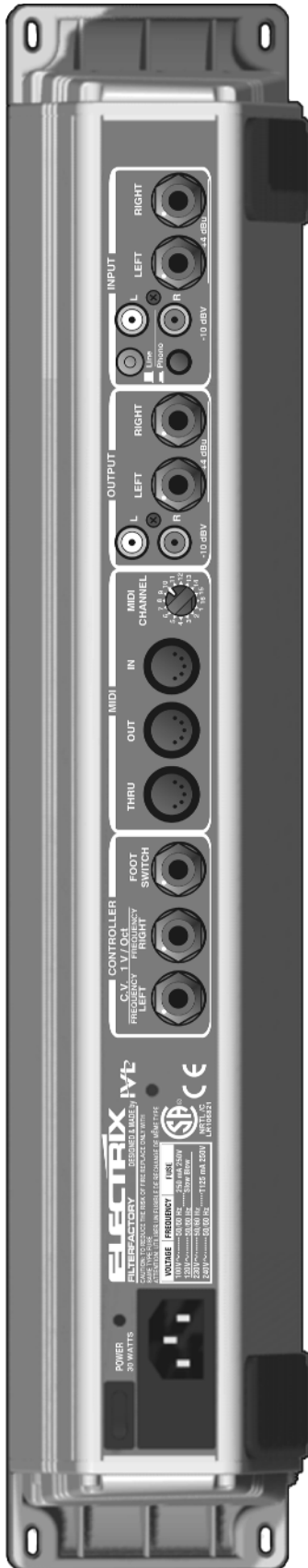

- ▶ **Power input:** This input will accept an IEC standard power cable. The internal power supply can be used in any region. The fuse drawer can be rotated to accommodate the different power ratings around the world. Check the chart printed near the power entry for fuse ratings.
- ▶ **Power Switch:** Turns the FilterFactory on and off. When turning on your equipment be sure to turn your power amplifiers on last. This will ensure that the noise common to mixers and signal processors does not cause damage to your speaker system. When powering down, be sure to turn your power amplifiers off first.
- ▶ **CV left and right:** If you've got an old CV / Gate keyboard rig, FilterFactory will work in your current setup. You can control the Filter's frequency with a CV signal. (1 volt per octave).
- ▶ **Footswitch:** Use a standard momentary footswitch to turn Bypass on and off. FilterFactory can accept normally open or normally closed footswitches. The footswitch must be inserted before power is turned on so that FilterFactory can recognize its type.
- ▶ **MIDI In/Out/Thru:** Connect MIDI devices here. See the MIDI Applications section for more detail.
- ▶ **Channel Select:** This selects the MIDI send and receive channel.
- ▶ **Output:**
  - RCA -stereo** - The RCA output level is nominally +4 dBu
  - 1/4"-stereo TRS**- This output produces a balanced +4 dBu signal.
- ▶ **Input:**
  - Phono/Line Switch** - this switches the RCA inputs to accept phono or line level.
  - RCA -stereo** - When the Phono/Line switch is in the Line position, this input is optimized for a +4dBu input signal. When the Phono/Line switch is set to Phono, the RIAA phono pre-amp will accept a range of cartridge output levels.
  - 1/4" -stereo TRS Balanced** - This input is optimized for +4 dBu input signal. When using the 1/4" inputs, be sure to use the 1/4" outputs as well. This will ensure no noticeable signal loss.

Note: Connecting both RCA and 1/4 inch jacks to the input causes the level of the 1/4" input to drop. Make sure that when you are using the 1/4" inputs that nothing is connected to the RCA inputs.

## 3.1 SET UPS

### Pre-Mixer

The advantage of this setup in a live situation is that the FilterFactory effect can be auditioned (cued) while other sources are playing. A caution though; it is possible to get a large amount of gain with higher resonance settings, so when auditioning FilterFactory through headphones keep the level low and be careful with high settings of the Resonance control.

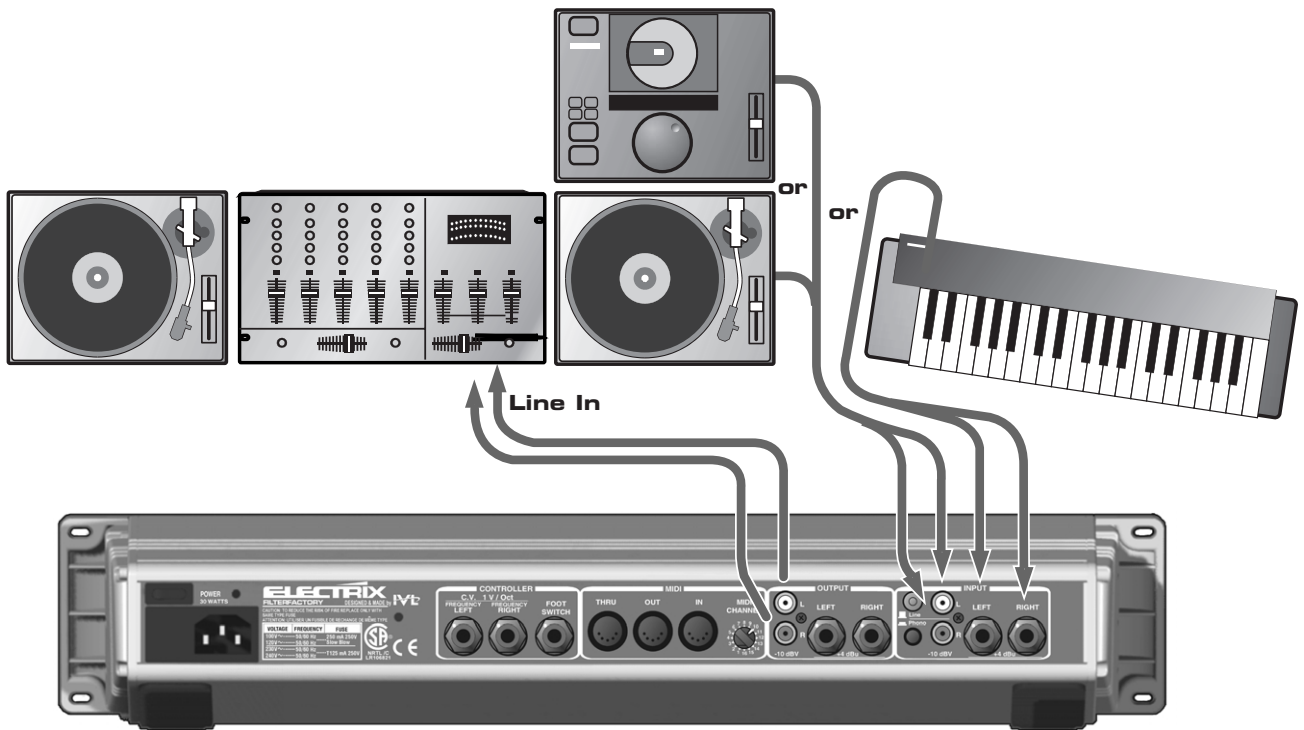

3.1 SET UPS

Mixer with Aux Send

This setup requires a mixer with auxiliary (aux) send and return capabilities. All sources are connected directly to the mixer channel inputs. FilterFactory is fed its signals from the mixer's aux sends. This setup allows any or all of your sound sources to be processed through FilterFactory at any time. The mix control on FilterFactory should be set to 100% wet so that the dry source signal is only heard through the mixer.

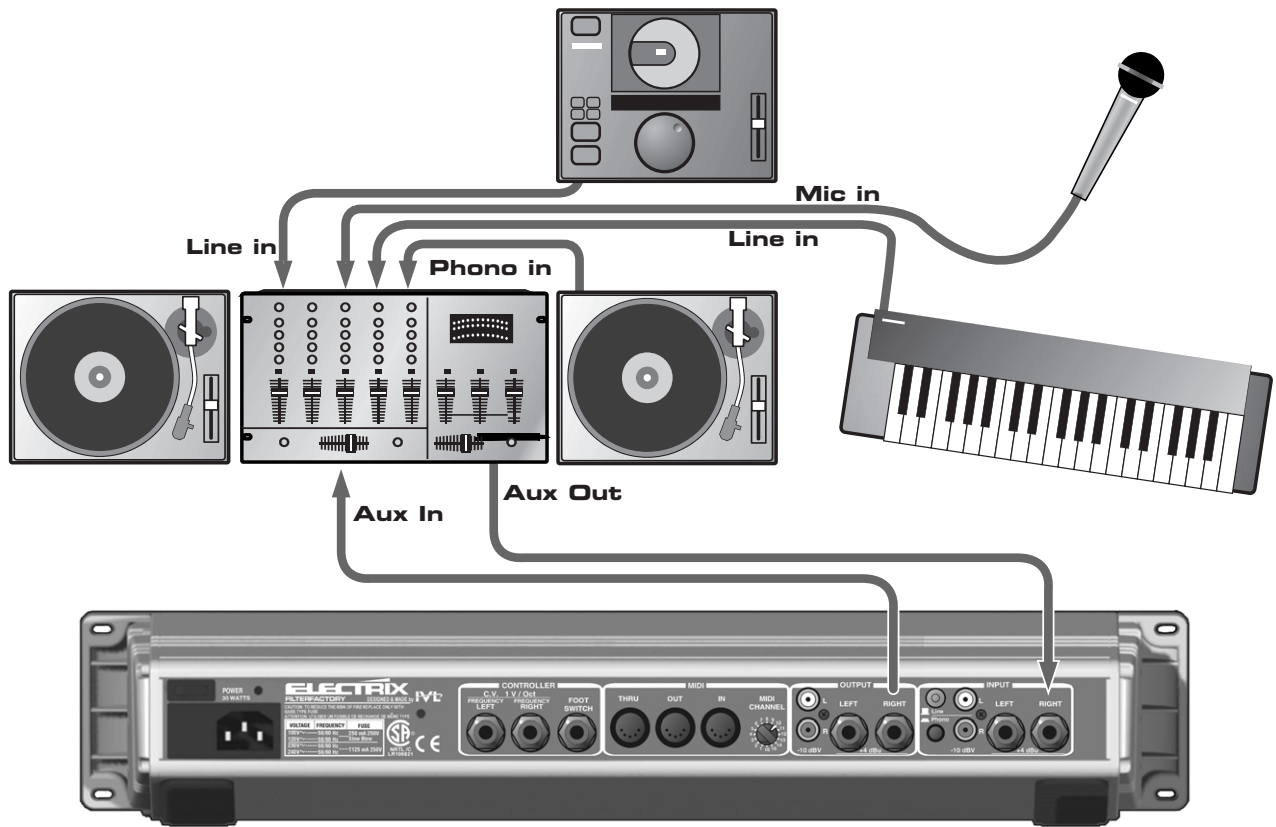

## 3.1 SET UPS

### Post Mixer

This is a simple setup for stereo processing of your entire mix. You'll want to use this setup only after you have explored all the sonic possibilities of FilterFactory because cueing is not possible. The cueing limitation can be minimized by bringing in the effect gradually with FilterFactory's mix control and doing any adjustments from there.

The 1/4" output jacks have servo driver circuits which are capable of driving longer cables to your power amp.

Also, this setup comes with a warning: WATCH THAT RESONANCE CONTROL! Like any true analog filter, FilterFactory is capable of generating ear- and PA-shredding peaks when you increase the resonance control beyond halfway. Have we made this point enough?

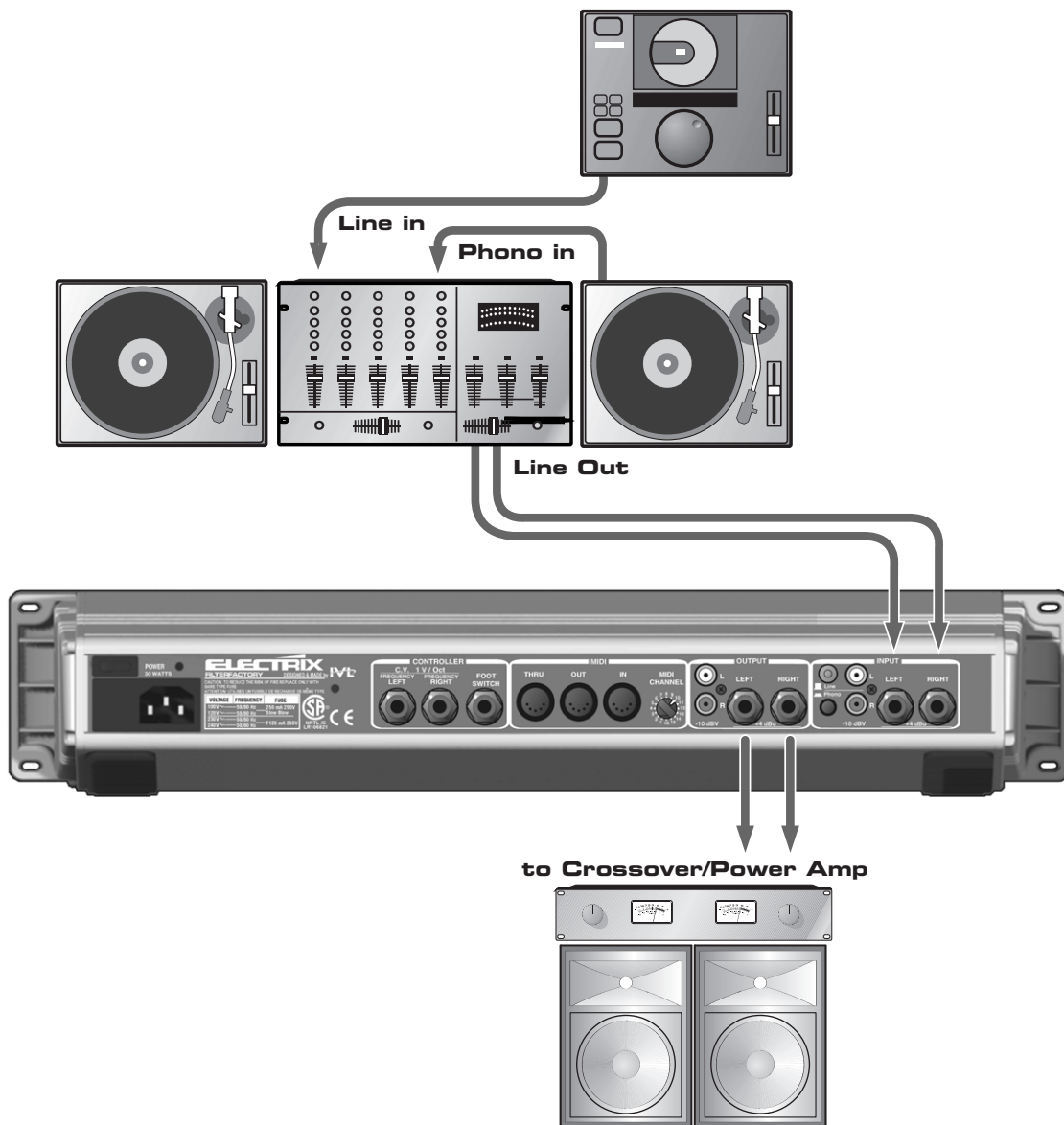

## 3.2 ARTIST APPLICATIONS

▶ **Tap Tempo Filter Swoosh**

**Buzz:** optional  
**Frequency Knob:** 640  
**Type:** Low Pass, High Pass  
**Resonance Knob:** Above 2.5 to as high as you dare.  
**4 Pole Mono:** On, but if you want 2 Pole stereo, turn up the Resonance and Depth more.  
**Waveform:** Try Ramp Dwon first, then try the other waveforms.  
**Singleshot:** On  
**Depth:** 5  
**Speed:** 9 O'Clock to 12 O'Clock on the knob  
**Division:** 1:1 to start. Try the other divisions with faster Speed settings.  
**Effect Mix:** 100 % or to taste

▶ **Phase Shifter effect**

That swooshy sound, that was initially made popular as a Fender Rhodes effect, is also available in the FilterFactory. This effect works especially on sounds with sustained portions such as voice, synth pads and of course, Fender Rhodes. A bass track with the Buzz engaged and Notch filtering is awesome.

**Buzz:** optional  
**Frequency Knob:** 115 plus 2 ticks  
**Type:** Notch  
**Resonance Knob:** 0  
**4 Pole Mono:** On  
**Waveform:** Triangle (looks like mountains)  
**Singleshot:** Off  
**Depth:** 10  
**Speed:** Experiment - slow is good, medium warble is nice too.  
**Division:** Off  
**Effect Mix:** 100 %

### ▶ *Funk Drum FX*

You can use the Envelope Follower waveform in the LFO section to create a “Bwow” sound that exactly follows the dynamics of rhythmic input. Here’s how it’s done:

**Buzz:** *off*  
**Frequency Knob:** *115*  
**Type:** *Band Pass*  
**Resonance Knob:** *2.5*  
**4 Pole Mono:** *Off*  
**Waveform:** *EnvFollow*  
**Singleshot:** *Off*  
**Depth:** *Less than 10*  
**Speed:** *Off*  
**Division:** *Off*  
**Effect Mix:** *To taste*

Playing with the Depth and Frequency knobs will customize the effect to your liking. Changing the Filter Type will emphasize different frequency bands. Note that when you try the Notch filter type setting, you’ll have to set resonance to zero and the frequency knob to around 640.

## 4.1 RECORDING AND PLAYING BACK PERFORMANCES WITH A SEQUENCER

**F**lectrix products are performance products. We have designed them to accurately transmit and receive your performance through MIDI. That means every knob and every switch can be automated. To do this, simply connect your FilterFactory to a sequencer. FilterFactory has MIDI Control Change messages assigned to all of its functions. That means your performance will show up in your sequencer as MIDI CC's (Control Change Messages).

Note that a press and hold of the bypass button will dump the present state of the controls. MIDI CC #18 will request a dump of state.

### ▶ ***Real Time Control***

The FilterFactory has a great alternative MIDI control feature. You can control the frequency control with your keyboard using MIDI Note Numbers. Here's how...set the filter to self resonate by bring the resonance up quite high, then play monophonically on a keyboard plugged into the MIDI in on the FilterFactory for some pitched effects.

### ▶ ***MIDI Clock***

The FilterFactory can receive MIDI clock messages. It will re-sync its Tap Tempo to the incoming MIDI clock for you automatically. This could be a great convenience for you if have a Drum Machine or Groovebox to sync to. Just set up your MIDI clock source to transmit MIDI clock, connect a MIDI cable from the source's MIDI OUT to the FilterFactory's MIDI in and press start on your MIDI clock source.

**Note:** The LFO speed control overrides the Tap Tempo and the incoming MIDI clock tempo. That means if you adjust it you will loose sync to your Tap Tempo / MIDI Tempo. To re-sync to MIDI Clock, hit Tap Tempo.

### ▶ ***Setting the MIDI Channel***

On the back of your FilterFactory is a small rotary switch labeled MIDI channel. Use it to set the Transmit / Receive channel of your FilterFactory.



## 4.2 MIDI IMPLEMENTATION CHART

Function		Transmitted	Recognized	Remarks
Basic Channel	Selectable	1-16	1-16	
Mode	Default Messages	X X	Mode 3 X	
Note Number		X	0	Controls Filter Frequency
Velocity	Note ON Note Off	X X	X X	
After Touch		X	X	
Pitch Bender		X	0	Controls Filter Frequency
Control Change	1 2 3 4 5 6 7 8 <sup>1</sup> 9 10 <sup>2</sup> 11 <sup>3</sup> 12 13 <sup>4</sup> 16 <sup>5</sup> 17 18 67			LFO Depth (Mod Wheel) Pre-Buzz Level Post-Buzz Level Buzz Engage Filter Frequency Wet / Dry Mix Filter Resonance Filter Type Filter Engage LFO Waveform LFO Single Shot LFO Rate LFO Division Filter Poles Bypass Dump Request Tap Tempo
Program Change		X	X	
System Exclusive		X	X	
System Common	Song Position Song Select Tune Request	X X X	X X X	
System Real Time	Clock Commands	X X	0 0	Tempo (LFO Speed) Restarts LFO in sync with MIDI clock
Aux Messages	Local On/Off All notes Off Active Sensing System Reset	X X X X	X X X X	
<p>Notes</p> <ol style="list-style-type: none"> <li>1. Filter Type: 0 (low pass), 1 (high pass), 2 (band pass), 3 (notch)</li> <li>2. LFO Waveform: 0 (sawtooth), 1 (inverse sawtooth), 2 (triangle), 3 (square), 4 (random), 5 (envelope follow)</li> <li>3. LFO Single Shot, 0-63 (continuous LFO waveform), 64-127 (single shot LFO waveform)</li> <li>4. LFO Division: 0 (1:1) 1 (2:1) 2 (3:1) 3 (4:1) 4 (6:1) 5 (1:2) 6 (1:4)</li> <li>5. Filter Poles: 0-63 (2-pole), 64-127 (4-pole)</li> </ol>				
Mode 1: OMNI ON, POLY		Mode 2: OMNI ON, MONO		0: YES
Mode 3: OMNI OFF POLY		Mode 4: OMNI OFF MONO		X: NO

# SPECIFICATIONS

<b>INPUT</b>			
Connectors: (balanced)	1/4" TRS	RCA (Phono)	RCA (Line)
Max Input Level:	+12.5 dBu	-24.5dBV	+12.5dBu
Impedance:	110K $\Omega$	47.5K $\Omega$	20K $\Omega$
<b>OUTPUT</b>			
OUTPUTS			
Connectors:	1/4"TRS bal	RCA	RCA
Impedance:	600 $\Omega$	1K $\Omega$	1K $\Omega$
Max Output Level:	+12.5 dBu	+12.5 dBu	+12.5 dBu
<b>PERFORMANCE</b>			
	1/4"	PHONO	RCA
Dynamic Range:	>90db	>75db	<90db
THD:	<0.3%	<0.3%	<0.3%
Frequency Response:	10Hz-20.0kHz	10Hz-20.0kHz	10Hz-20.0kHz
<b>POWER CONSUMPTION</b> 30 watts			
VOLTAGE	FREQUENCY	FUSE	
100 V	50/60 Hz	250mA 250V Slow blow	
120 V	50/60 Hz		
230 V	50/60 Hz	125mA 250V "T"	
240 V	50/60 Hz		

Actual measurements are subject to change

This equipment has been tested and found to comply with the limits for a class A digital device, pursuant to part 15 of the FCC rules.

These limits are designed to provide reasonable protection against harmful interference in a residential installation.

This equipment generates, uses and can radiate radio frequency energy and, if not installed and used in accordance with the instructions, may cause harmful interference to radio communications. However, there is no guarantee that interference will not occur in a particular installation.

If this equipment does cause harmful interference to radio or television reception, which can be determined by turning the equipment on and off, the user is encouraged to try to correct the interference by one or more of the following measures:

- Reorient or relocate the receiving antenna.
- Increase the separation between the equipment and the receiver.
- Connect the equipment into an outlet on a circuit different from that to which the receiver is connected.
- Consult the dealer or an experienced radio TV technician for help.

The user may find the following booklet, prepared by the Federal Communications Commission, helpful:

***"How to identify and Resolve Radio/TV interference Problems."***

This booklet is available from the US Government Printing Office, Washington, DC 20402, Stock No. 004-000-0034-4.

▶ **Caution:**

You are cautioned that any change or modifications not expressly approved in this manual could void your warranty.

▶ **For the customers in Canada:**

This Class A digital apparatus meets all requirements of the Canadian Interference-Causing Equipment Regulations.

Cet appareil Numérique de la Classe A respecte toutes les exigences du Règlement sur le matériel brouilleur du Canada.

▶ **Certificate of Conformity**

Electrix, (a Div. of IVL Technologies LTD) hereby declares on own responsibility that the following product

***Electrix FilterFactory***

that is covered by this certificate and marked CE-label conforms with the following standards:

- EN 60065 Safety requirements for mains operated Electronic and related apparatus for household and similar general use
- EN 55103-1 Product family standard for audio, video, audio-visual and entertainment lighting control apparatus for professional use.  
Part 1: Emission
- EN 55103-2 Product family standard for audio, video, audio-visual and entertainment lighting control apparatus for professional use.  
Part 1: Immunity

With reference to regulations in following directives:

72/23/EEC, 89/336/EEC as amended by directive 93/68/EEC

Issued in Victoria, March 31, 1999 by Brian Gibson, Executive Vice-President, Research and Development