

The Polymode virtual instrument is inspired by one of the world's first polyphonic synthesizers of the 70s. Its unique multiple filter implementation and mod routings gives it a sound like no other synth - it excels at large pads, strings, and vocal-esque sounds.

Unfortunately, the original is known to be highly unreliable as a result of its elaborate circuitry and the inconsistent quality control of 70s electronic components. They were also really expensive (\$5200 in mid-70s dollars!), weighed a ton, sensitive to movement, and relatively confusing to operate. Cherry Audio Polymode sidesteps every one of these drawbacks - hooray for modern computers! Of course we've eliminated all of the original's reliability issues, we've updated its controls to make it far easier to use, and we've added extensive modulation routing to almost every control for an immense improvement in creative possibilities.



If you haven't purchased the full version of Polymode, it will run in demo mode. All functions will work, but inharmonic tones will occasionally sound (the LED next to *Demo* in the top toolbar will illuminate when the ugly tones are sounding). We've also added a handy button to make purchasing easy, so you've got no excuse! As you might expect, all this demo stuff disappears once Polymode is purchased.

Technical Assistance

Cherry Audio's unique online store and automatic updating should make operation a smooth experience, but if you run into any issues or have questions, you can discuss issues online at the Cherry Audio forums at:

<https://forums.cherryaudio.com/viewforum.php?f=44>

... or you can communicate directly with our surly and irritable, oops, outgoing and friendly tech support staff at:

<https://cherryaudio.kayako.com/>

Moog® is a registered trademark of Moog Music, Inc. There is no association, affiliation, or endorsement of Cherry Audio or its products by Moog Music, Inc.

Top Toolbar and Preset Browser



The purple strip at the top of the Polymode interface is where you'll load, save, and create sound presets. It also contains utility functions such as undo, redo, UI zoom and *Focus* controls, under-the-hood settings, and more. Let's go over them:

New- Opens a new blank patch preset. If an unsaved patch is currently open or you've modified an existing saved patch, a dialog asks if you'd like to save the patch in its current state. This greatly reduces the possibility of losing an edited unsaved patch.

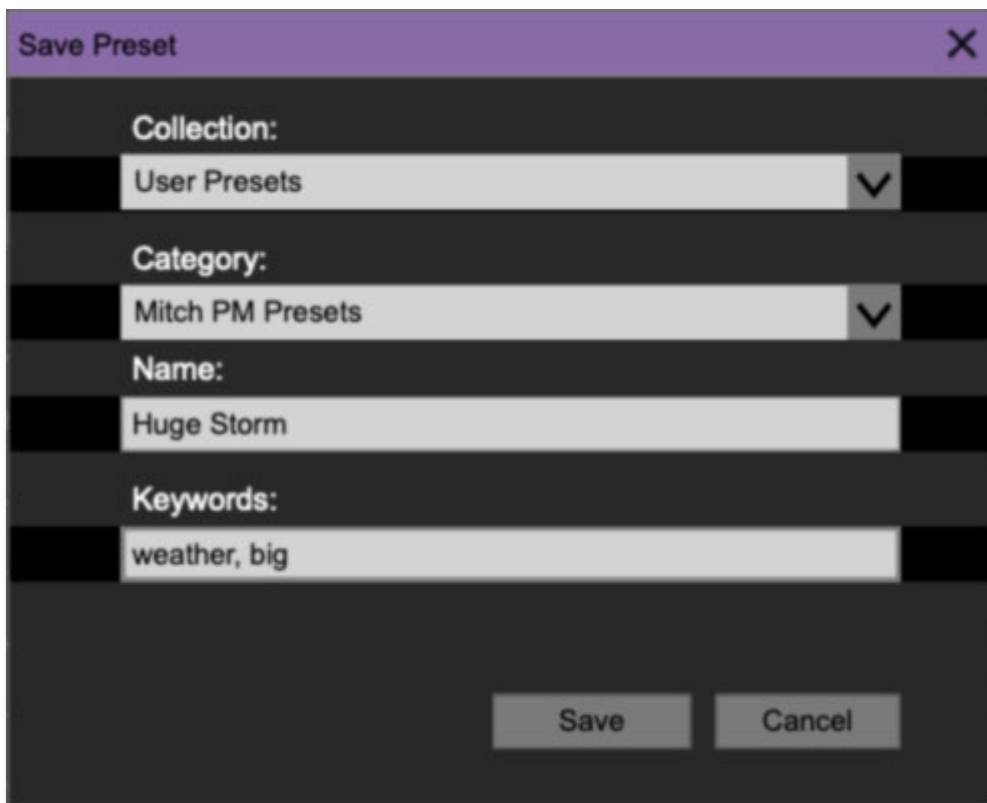

Save- Use this to save patches. There are a couple of levels of hierarchy:

- *Collection*- This is the top level of organization, and contains entire “sets” of presets. The *Polymode Presets* are the main included collection. We also include a *User Presets Collection* for storing your own presets, but you're free to create your own collections. To create a new collections, click in the *Collection* text field (where it says *User Presets* above) and

type a name. User-created sounds can be freely saved to any collection; we like to keep 'em separated for organizational purposes.

- *Categories*- Within each *Collection* are a number of sound categories. As with collections, you're free to create as many categories as you like. To create a category, click in the *Category* text field of the *Save* dialog window and type a new category name.
- *Patch*- A patch is an individual sound. To save a patch, simply type the name in the *Name* field and click *Save*.
- *Keywords*- You can add descriptive words such as "huge," "noisy," etc., to patches to make them appear when terms are typed in the *Search* field. Use commas to separate multiple keywords entries.

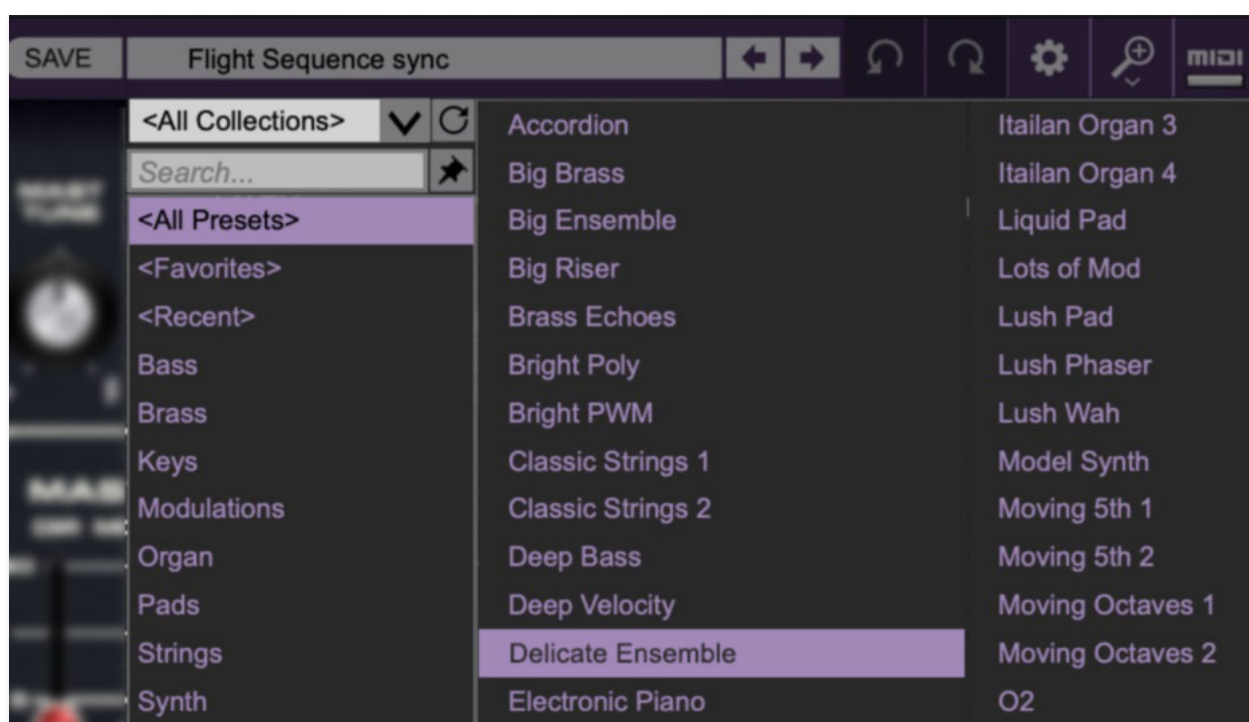

Browsing Patches- Patches can be browsed by clicking the *<Select Preset>* field. To select a preset collection, click in the area that says *<All Collections>* or on the downward-facing arrow next to it.

Clicking on the left-side categories narrows down which patches are displayed.

- *<All Presets>* will show presets from all collections and categories.
- *<Recent>* displays recently used presets.
- *Refresh*- This is the circular arrow button to the right of the downward arrow; clicking this checks the Cherry Audio server for new or updated

presets.

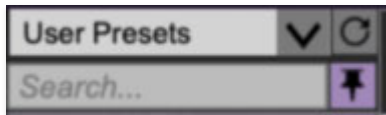

Pin - Clicking the push-pin icon locks the patch selection list open, allowing fast and easy browsing and auditioning of patches. Click the icon again to disable pin mode. when in pin mode, the up and down arrow keys can be used to select patches.

Preset- Step Back/Forward Arrows- These step to the previous or next preset. macOS [⌘+left/right arrow key] or Windows [CTRL+left/right arrow key] will navigate through presets back and forth in the currently selected collection/category.

Undo/Redo- These circular arrows will undo or redo the last action. It remembers many steps, so if you really loused something up, keep on clickin'...

Settings- This is where user preferences for user interface, audio interfaces, user account, and more are configured. See the [Settings](#) section for full information.

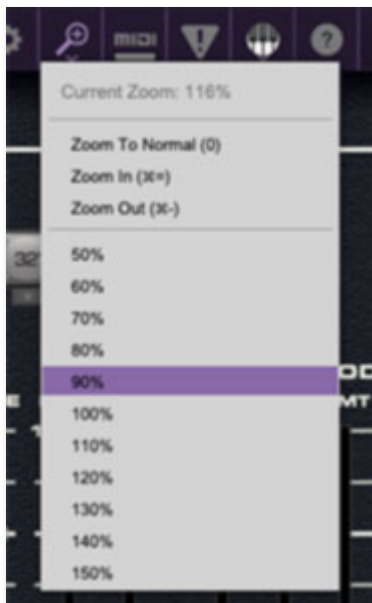

Importing Presets with drag-and-drop

Presets can be imported singly or en masse (as a single compressed ZIP file) simply by dragging and dropping from the desktop anywhere on the user interface.

If a single *.preset file is dragged and dropped, the sound is immediately loaded and the standard Save Preset dialog appears; this lets you save the sound to the instrument's preset browser. Note that you don't have to save the sound to preset browser; if you just want to hear and play the sound, click the Cancel button in the Save Preset dialog - the sound will still be loaded.

Compressed zip files containing multiple sounds can also be drag and dropped onto the UI. This works the same as with single sounds, but instead of the Save Preset dialog, you'll see the Import Preset Collection dialog. The presets will be added as a new collection and available in the categories for which they were tagged.

Zoom Magnifying Glass- Click to resize the Polymode interface. Selecting *100%* returns the user interface to native size.

MIDI Tab- Opens the MIDI controllers tab for configuring internal and hardware MIDI controls. See the **MIDI Controllers Setup and MIDI Tab** section for full information.

! (MIDI Panic) - Click to send an all-notes-off message in case of, "why won't this thing stop making noise?!?" stuck-note incidents.

Tempo (Standalone Version Only)- Displays Polymode's current internal tempo setting. Polymode's internal tempo affects the *Echo*, and *Modulator 1* and *2* sections when their corresponding *Sync* buttons are toggled. The tempo setting can be changed by moving the mouse up and down anywhere in the tempo section, or by double-clicking the number and entering the desired BPM value.

The tempo display only appears in the standalone version of Polymode. VST, AU, and AAX plug-in versions receive tempo data from their host DAW app.



QWERTY Musical Typing Keyboard- Opens an onscreen keyboard allowing a standard QWERTY computer keyboard to be used for playing music notes. For more information, see **QWERTY Musical Typing Keyboard (MTK)** section.



Help - Clicking this launches your web browser and opens the help document you're currently reading, which is a really meta concept.

Polymode Synthesizer and *Cherry Audio* logos - Clicking these displays "about" information, and shows the version number and current registered user ID.

Focus Button



Since the original instrument is a rather large animal, and maybe your computer display isn't so huge, the UI can potentially be hard to see. With this in mind, the *Focus* button conveniently blows up the user interface to roughly twice its normal size within the current window size. Unlike the *Zoom* "magnifying glass" function, *Focus* doesn't affect the current window size. By default, the patch panel section fills the current window, but the view can be scrolled vertically and horizontally with a mouse wheel, track pad, or Apple Mighty Mouse finger-scrolling. Or if you're the last person on earth still using a single-button mouse, scroll bars will appear at the window edges when in *Focus* mode. (Drop us a line from that hotmail.com email account, umkay?)

Using *Focus* mode couldn't be easier - just click the *Focus* button the top menu bar. To return to standard view, click *Reset*. **There's also a superfast key shortcut** - on Mac, hold the ⌘ [COMMAND] key and click the mouse; in Windows, hold the [OPTION] key and click the mouse. Focus can be reset with the same key shortcuts.

Preset List Right-Click Functions

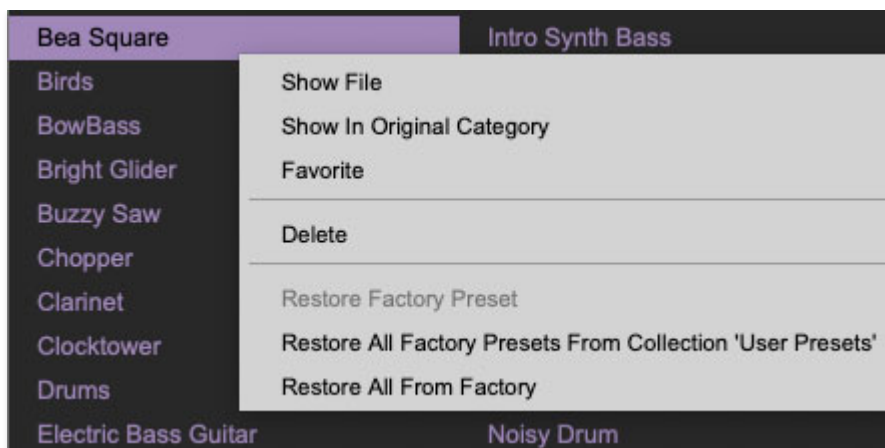

Show File- This displays the selected preset in the Mac or Windows folder containing it. This is useful for backing up or sending a preset file to another user.

Show In Original Category- Selects the preset within its category, i.e. the category will highlight in the left preset menu. The *Show In Original Category* command only displays if the preset was selected within the *<All Presets>*, *<Favorites>*, or *<Recent>* categories.

Favorites- Favorited presets will show in when the *<Favorites>* category is selected. A star will display next to the preset name. Right-click on the preset and reselect *Favorite* to un-favorite it.

Delete- Deletes the selected preset.

Restore Factory Preset- If one of the factory (i.e. not user) patches is edited and saved, selecting this command restores the patch to its unaltered "factory" setting. This menu will be grayed-out for user bank patches.

Restore All Factory Presets From 'Polymode Presets'- If any patches from the "factory" Polymode bank are edited and saved, selecting this command restores *all* of them to their unaltered "factory" setting.

Restore All From Factory- If any patches from the "factory" banks are edited and saved, selecting this command restores *all* of them to their unaltered "factory" setting. At the time of writing, the Polymode bank mentioned above is the only factory bank, so this function and the *Restore All Factory Presets From Polymode Presets'* above have the same effect.

Polymode Signal Flow

The original Polymoog works like a string synthesizer (or a transistor organ) on steroids. The pitches of two fixed high-frequency square-wave oscillators are "divided-down" (i.e. slowed down) to the frequency of each chromatic note of the very top octave. Another series of IC's halves the top-octave chromatic notes to create the remaining pitches for the entire length of the keyboard. This is how just about every 60s and 70s transistor organ and 70s string synth works (as well as a number of 70s polyphonic sort-of synthesizers such as the ARP Quadra, Korg Delta, etc.).

Though it sounds convoluted, top-octave divide synthesis (referred to as "TOC") was common because it's easy and cheap from an electronics standpoint, but it can only product square waves, which severely limits the tonal palette. To get around this, the original instrument contained a small circuit board called a "poly card" beneath each key with a custom IC chip (the "Polycom IC") that converted the square wave to a ramp wave and allowed the pulse width of the square wave to be adjusted and modulated. Because of its separate note generation for each key, TOC-based synths can't have a "mono mode," thus keyboard glide can't be implemented. Here's a block diagram of the signal path:

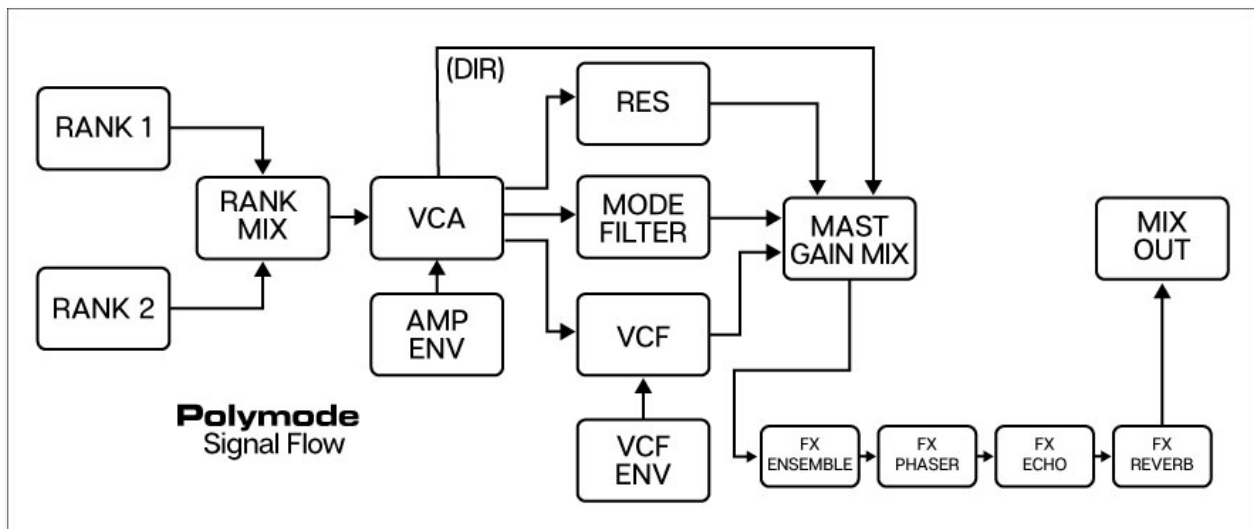

Following the oscillator "ranks" are the VCA/Amplitude Envelopes. This is unlike just about any other analog synthesizer - the VCA is almost always *after* the filter(s), not before. This is because the original featured individual VCA/Amplitude envelopes for every note on the aforementioned poly com cards beneath each key. It also means that *every single note has its own independent envelope generator*. The downside of this arrangement it that

the VCF cannot be self-resonating because once it started "ringing," there would be nothing to stop its sound - in a more conventional analog synth, playing the keyboard would open and close the VCA, thereby stopping sound from the ringing filter.

Following the VCA/Amplitude Envelopes are three (!) separate filters, all fed in parallel. Mixing and matching these in the *Master Gain* mixer section, along with the unfiltered *Direct* signal, is one of the niftiest things to do with the original (and this is greatly enhanced by the *Master Gain* mixer's mod inputs). The filters are as follows:

- **Resonators** (see [Resonators](#) section for details)
- **Mode Filters** (see [Mode Filters](#) section for details)
- **VCF** (see [VCF and Filter Envelope Sections](#) for details)

The *Resonators*, *Mode Filters*, *VCF* are fed to the *Master Gain* mixer, then to the *Ensemble*, *Phaser*, *Echo*, and *Reverb* effects, then to the *Master Out* volume knob and main audio outputs.

Lower/Upper/Octave Bal Controls- The original instrument included "lower" and "upper" duplicates of a number of its controls, allowing independent adjustment of various parameters at a fixed keyboard split point. Because only certain parameters had the dual controls, this resulted in a pretty half-baked attempt at keyboard split capabilities, and along with the already unusual control layout, tended to make it even more confusing. On top of this, it had three volume sliders that split the keyboard into three volume zones (with different fixed split points than the upper/lower controls!) for extra bonus confusion. We've eliminated all of this extra-control-splitty madness from Polymode - if you've never had your hands on the real thing, take our word, we did you a solid by ditching these confounding controls.

In the following chapters, we'll detail each of Polymode's sections. Normally we would cover controls from left to right, but it doesn't exactly have a left-to-right signal flow, we'll start with the oscillator *Rank* controls, then follow the actual signal path.

Oscillator Ranks



On the original instrument, each of the two polyphonic oscillator banks is referred to as a "rank," which is good ol' medieval organ terminology (as are commonly used octave footage numbers). We made the decision to alter the layout of the oscillator rank section because the original rank controls are really confusing, and offer no improvement in functionality over the more standard layout we've implemented in Polymode. Additionally, the original allowed rank 1 to produce *only* square and pulse waves, and rank 2 to produce *only* ramp waves. We eliminated this limitation; both ranks can produce ramp/square/pulse waves in any combination. The controls for both oscillator ranks are identical and are as follows:

Range buttons- Sets the basic pitch range of the oscillator rank, displayed in traditional organ footage. Only one range button can be enabled at any time.

Waveform buttons- Selects ramp and/or pulse waves. These may be used independently or in combination.

Tune - Tuning control for pitch. This can be used to fatten up patches by detuning a small amount, or for "building-in" a set interval. Its range is an octave, up or down. The slider resolution is finer toward the middle in order to simplify detuning by small values.

FM - Rate/Amount- Each oscillator rank includes a dedicated triangle-wave LFO for frequency (pitch) modulation. The *Rate* slider controls LFO speed, and the *Amount* slider controls LFO depth.

Shape/Mod - Shape- Sets the initial pulse-width of the pulse wave. 5% is narrowest setting and 50% is a full square wave.

Shape/Mod - Rate/Amount- Each oscillator rank includes a dedicated triangle-wave LFO for pulse-width modulation (i.e., separate from the frequency mod LFO). The *Rate* slider controls LFO speed, and the *Amount* slider controls LFO depth.

Mod Source buttons and Attenuator knobs- The *Mod Src* selector buttons and attenuators beneath the sliders allow positive or inverted voltage control of the slider directly above. Clicking the *Mod Src* selector button opens a pop-up menu where the mod source can be selected. Once a mod source is chosen, the button turns red and its text changes to indicate the current mod source. To choose a different mod source, click the button and choose another modulator, or choose *None* to disable modulation. The attenuator knobs beneath the *Mod Src* buttons set a positive or inverted voltage control amount for the controls.

Rank Mix- Balances the level of oscillator *Rank 1* and *Rank 2*. Set to the center position for an equal mix.

Polymode's LFO Smorgasbord - Most classic polysynths feature a single LFO, routed via some kind of mod destination selector. Polymode is unique in that it features a dedicated triangle-wave pitch mod and pulse width LFO, for *each* oscillator (because one of the original oscillator ranks was ramp-wave, it had an LFO for rank one pulse-width, and separate LFO's for pitch mod of each oscillator rank). **This multiple and independent modulation is the key to achieving the swirly, warbly sounds it's famous for, particularly the "Vox Humana" preset made famous by synthpop icon and spiffy dresser, Gary Numan.**

In addition to the four LFO's in the oscillator rank section, the *Filter* and *Resonator* sections have their own dedicated triangle-wave LFOs, we've included two full-featured, syncable "bonus" LFO's (routable via the *Mod Src*) buttons, and hey, while we're counting, another in the *Phaser*, and depending on which mode the *Ensemble* effect is set to, one more there, or two more in *Tri Chor* mode, bringing us to a total of up to 11 LFO's. We weren't kidding when we said Polymode was a modulation monster!

Resonators



The *Resonators* section is one of the original instrument's most unique features. It consists of three state-variable filters in a parallel configuration. The parallel routing means the signal is split and runs into all three filters with their collective outputs summed together. Cranking up the *Emph* controls (aka, resonance) for each band can create three individual "peaks" or resonances, hence the "resonator" name.

Another unusual aspect of the original Resonators section is that each is band-limited. Most synthesizer filters are configured such that the cutoff frequency covers the entire audible sound spectrum (20-20,000 Hz, give or take), whereas each of the three resonators cover a "slice" of the audio spectrum, i.e. low, med, and high frequencies as follows:

- **Low:** 60 - 300 Hz
- **Med:** 300 - 1500 Hz
- **High:** 1500 - 7500 Hz

The original *Resonators* section has two major shortcomings: the filter slopes are a little too shallow to create really dramatic resonance effects, and the cutoff frequencies aren't CV controllable. We've addressed both of these issues with a 12/24 db slope selector, as well as bipolar CV inputs for each cutoff frequency

The *Resonators* section excels at creating formant-type sounds, and is also great at emulating phaser-type sounds when its cutoff frequencies are swept via CV modulation.

Pass Mode - Globally selects the behavior of all three filters.

- **Lowpass:** Allows frequencies *below* the cutoff frequency setting to pass through,
- **Bandpass:** Combines *both* lowpass and highpass modes, leaving sound only in the middle of the audio spectrum. The cutoff frequency lies roughly halfway between the slope falloff on either side.
- **Highpass:** Allows frequencies *above* the cutoff frequency setting to pass through
- **Notch:** The opposite of a bandpass filter; a notch filter *removes* a narrow band frequencies in the middle of the audio spectrum, but leaves frequencies above and below unaffected. This might not sound all that useful, but modulating the cutoff frequency of a notch filter creates an effect similar (but not exactly the same) to a phaser. Stacking all three Resonator stages emphasizes the effect.

Slope- The nature of how a filter works is that frequencies "fall off" above or below the cutoff frequency. Slope adjusts the steepness of this falloff, hence the "slope" terminology. A 12db per/octave filter has a shallower slope, giving it a clearer and brighter character, whereas a 24db per/octave filter's steeper slope gives it a tighter and darker tone and far more pronounced ringing characteristic when the *Emph* slider is turned up.

Since the controls for the *Low*, *Med*, and *High* sections are the same other than frequency range, we'll explain them once:

CF (Cutoff Frequency)- Sets the frequency where attenuation begins. Attenuation will be above or below this frequency (or both) depending on the *Pass Mode* switch setting.

Emph (Resonance)- Emphasizes sound energy at and around the current cutoff frequency by adding feedback from the filter's output back to its input. At lower settings, this can be used to create mild resonances such as those

heard in acoustic instruments. At more extreme settings, resonance can create a pure sine wave at its own frequency (variable via the *CF* slider). Be careful with the *Emph* sliders as they can get loud at extreme settings (you can easily control this using each section's *Gain* slider). Note that this "ringing" resonant frequency is much more prominent with the *Slope* switch in the *24db* position.

Gain- This acts as a volume control for each resonator section. Resonator sections can be muted by setting their *Gain* control to 0%.

Mod- Rate/Amount- The Resonators section on the original sounds really awesome when you sweep cutoff frequency sliders, but the sliders can't be voltage controlled. It sounds so nifty that we added a dedicated triangle-wave LFO, much like the FM and shape mod LFO's built into the oscillators. Of course the Resonators cutoff frequencies can also be modulated with *Modulator 1* and *Modulator 2* via the *Mod Source* buttons and attenuators explained below, but the dedicated LFO means you won't have to "waste" one of the extra modulators, and it makes modulating the Resonators section fast and simple.

- **Rate-** Sets the LFO mod speed from 0.05-10 Hz.
- **Amount** - Sets the mod depth from 0 to 100%.

Note that the *Mod* controls affect all three resonator sections equally. If you'd like to modulate the Resonators' individual sections separately, use the *Mod Source* buttons and attenuator knobs.

Mod Source buttons and Attenuator knobs- The *Mod Src* selector buttons and attenuators beneath the sliders allow positive or inverted voltage control of the slider directly above. Clicking the *Mod Src* selector button opens a pop-up menu where the mod source can be selected. Once a mod source is chosen, the button turns red and its text changes to indicate the current mod source. To choose a different mod source, click the button and choose another modulator, or choose *None* to disable modulation. The attenuator knobs beneath the *Mod Src* buttons set a positive or inverted voltage control amount for the controls.

Mode Filters



On the original instrument these buttons allowed selection of hard-wired sound presets; in addition to changing waveform, octave, and envelope parameters, the numbered preset buttons also routed audio through fixed filter circuits. Each preset had its own custom fixed filter board, known as a "mode filter." **Unlike a typical synth filter, they have no external controls and they aren't voltage controllable, so they can't change timbre over time.** It's best to think of the *Mode Filters* as preset EQ curves.

Given Voltage Modular's sophisticated factory and user preset browser, we felt it would be redundant (and potentially confusing) for the *Mode* preset buttons to affect all of Polymode's controls, so please keep in mind that the ***Mode filter names refer only to the mode filters themselves, not entire sound patches*** (the factory presets are accurately reproduced and appear in the included in the *Factory* presets folder).

There were actually two original instrument models - the 203A, which is the full-tilt boogie version with numerous controls, and eight sound presets/mode filters. A couple of years later, a less expensive, cut-down version (model 280a) was released., but it increased the number of presets (and mode filters) to 14. Generally speaking, the 280A is less desirable, but it featured the desirable "Vox Humana" preset. As a result, many Polymoog 203A owners have their instruments modified to eliminate one of the lesser presets and replace it with the Vox Humana settings and mode filter PCB. We've essentially done this in the Polymode module - it retains all eight of the standard mode filter presets and adds Vox Humana as a ninth "extra" preset.

To use the *Mode* filters, simply select one and raise the *Mode* slider in the *Master Gain* section. The LED numeric indicator displays the currently selected mode filter. As mentioned, switching mode filters won't

affect other parameters (unlike a real one, which annoyingly jumbles the current octave and waveform settings).

VCF and Filter Envelope Sections

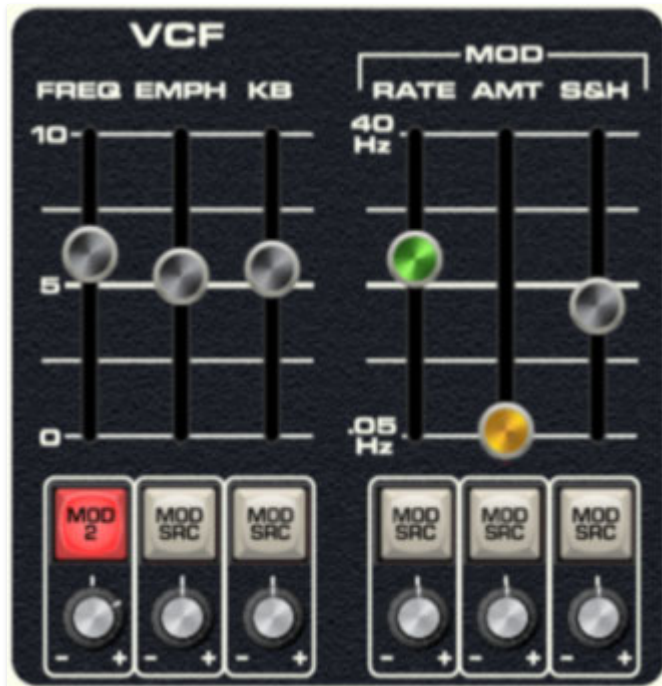

This is a standard 24db per/octave voltage-controlled lowpass filter along with a dedicated envelope generator for cutoff frequency control. Being a lowpass filter, it removes high frequencies as its cutoff frequency setting is decreased from max. Note that **this is a single filter for all voices**, sometimes referred to as a "paraphonic" implementation. This means that it's global for all notes, and the VCF envelope will retrigger any time a new note is played. This isn't so great for piano, clav, or other percussive sounds, but it's not too much of an issue for sustained pad, string, or organ-type sounds. The VCF and VCF Envelope controls are as follows:

Frequency - Sets the frequency where high-frequency attenuation begins.

A note about max cutoff frequency: If the cutoff frequency is open all the way, the sound still won't be at full brightness; in other words, some high frequencies are still attenuated. Full filter brightness can be achieved by using the VCF Envelope (detailed below), or by adding CV from the a mod source via the cutoff frequency *Mod Src* routing button and attenuator knob. This was done to accurately emulate the behavior of the real instrument's VCF (a lot of vintage analog synths have this behavior).

Emph (Resonance)- Emphasizes sound energy at and around the current cutoff frequency by adding feedback from the filter's output back to its input. Useful for typical synth "wah" sounds.

Mod - Rate/Amount - The VCF section includes an independent triangle-wave LFO that's hard-wired to frequency modulation. The *Rate* slider controls LFO speed, and the *Amount* slider controls LFO depth.

Mod - S&H (Sample and Hold) - Applies sample and hold (aka, random) modulation to the cutoff frequency. The sample and hold rate is controlled by the same clock as the triangle-wave LFO above, thus its rate is set with the same *Rate* control. The triangle-wave LFO and S&H can simultaneously modulate the cutoff frequency as desired.

Mod Source buttons and Attenuator knobs- The *Mod Src* selector buttons and attenuators beneath the sliders allow positive or inverted voltage control of the slider directly above. Clicking the *Mod Src* selector button opens a pop-up menu where the mod source can be selected. Once a mod source is chosen, the button turns red and its text changes to indicate the current mod source. To choose a different mod source, click the button and choose another modulator, or choose *None* to disable modulation. The attenuator knobs beneath the *Mod Src* buttons set a positive or inverted voltage control amount for the controls.

VCF Envelope



The VCF Envelope beneath the VCF section exclusively controls the VCF described above. Its controls are as follow:

Att (Attack)- Defines the length of time for VCF cutoff mod voltage to rise from minimum to maximum.

D/R (Decay/Release)- Defines the length of time for VCF cutoff mod voltage to fall from the *Att* stage peak to *Sus* stage setting (key held) or fall to zero

(key released).

Sus (Sustain)- Sets the held VCF cutoff mod voltage following *Att* and *D/R* phases (key held).

Amt (Amount)- Defines the depth of envelope control of VCF cutoff. A setting of 0 has no effect on cutoff frequency; a setting of 10 would be maximum control.

Master Gain Mixer

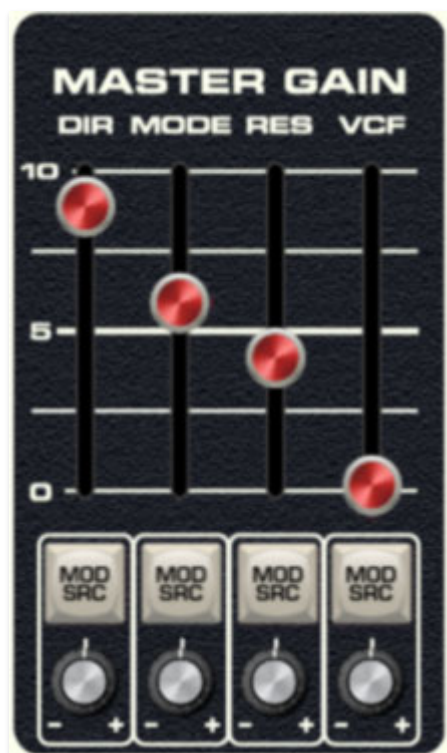

The *Master Gain* section is where all Polymode signals are mixed. **At least one fader in the *Master Gain* section must be up or no sound will be audible.**

Dir (Direct)- Sets *Direct* signal output amount. This signal is the combination of both oscillator ranks, following the *Rank Mix* slider and prior to any of the filters.

Mode- Sets the *Mode Filters* output level.

Res (Resonators)- Sets the *Resonators* output level.

VCF- Sets the *VCF* output level.

Mod Source buttons and Attenuator knobs- The *Mod Src* selector buttons and attenuators beneath the sliders allow positive or inverted voltage control of the slider directly above. Clicking the *Mod Src* selector button opens a pop-up menu where the mod source can be selected. Once a mod source is chosen, the button turns red and its text changes to indicate the current mod source. To choose a different mod source, click the button and choose another modulator, or choose *None* to disable modulation. The attenuator knobs beneath the *Mod Src* buttons set a positive or inverted voltage control amount for the controls.

VCA and Amplitude Envelope Sections



VCA is short for “voltage-controlled amplifier,” and for all intents and purposes, you can think of it as an automated volume knob. The original instrument did not include a master VCA, but we've added it for increased flexibility. Most significantly, it enables tremolo and pulsing sounds (using the Mod Source routing beneath it with Modulator 1 or 2) that couldn't be created on an original instrument.

Amount- This works like the master volume control, but the modulation input explained below adds all kinds of amplitude modulation capabilities, unavailable in the original instrument.

Mod Source button and Attenuator knob- The *Mod Src* selector button and attenuator beneath the slider allow positive or inverted voltage control of the *Amt* slider. Clicking the *Mod Src* selector button opens a pop-up menu where the mod source can be selected. Once a mod source is chosen, the button turns red and its text changes to indicate the current mod source. To choose a different mod source, click the button and choose another modulator, or choose *None* to disable modulation. The attenuator knob beneath the *Mod Src* button set a positive or inverted voltage control amount.

Amplitude Envelope

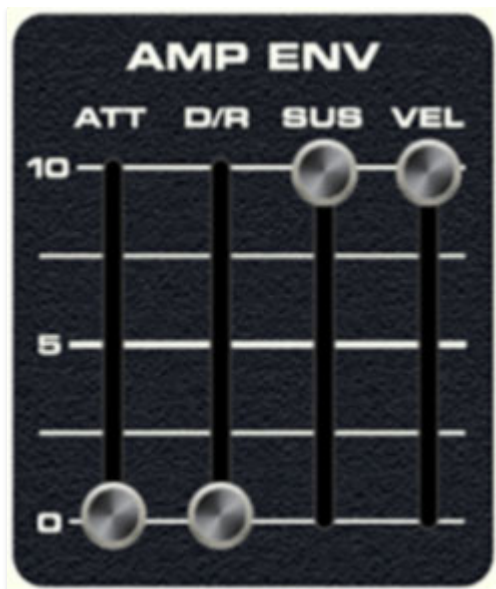

The Amp Envelope controls Polymode's voice amplitude. Like most modern poly synths, each voice (up to a maximum of 32) has its own independent envelope and associated voltage-controlled amplifier.

Vel (Velocity)- Defines how much the envelope affects amplitude via keyboard velocity. Remember that the IO Panel Poly Sources *Poly Vel* output is normalised to the Controls *Poly Vel* input, so you won't need to patch a cable to utilize amp envelope velocity. A setting of zero gives maximum dynamic range; at a setting of 10, keyboard velocity has no effect on amplitude, and is essentially full blast all the time.

Att (Attack)- Defines the length of time for VCA amplitude mod voltage to rise from minimum to maximum.

D/R (Decay/Release)- Defines the length of time for VCA amplitude mod voltage to fall from the *Att* stage peak to *Sus* stage setting (key held) or fall to zero (key released).

Sus (Sustain)- Sets the held amplitude voltage following *Att* and *D/R* phases (key held).

Modulator 1 and 2

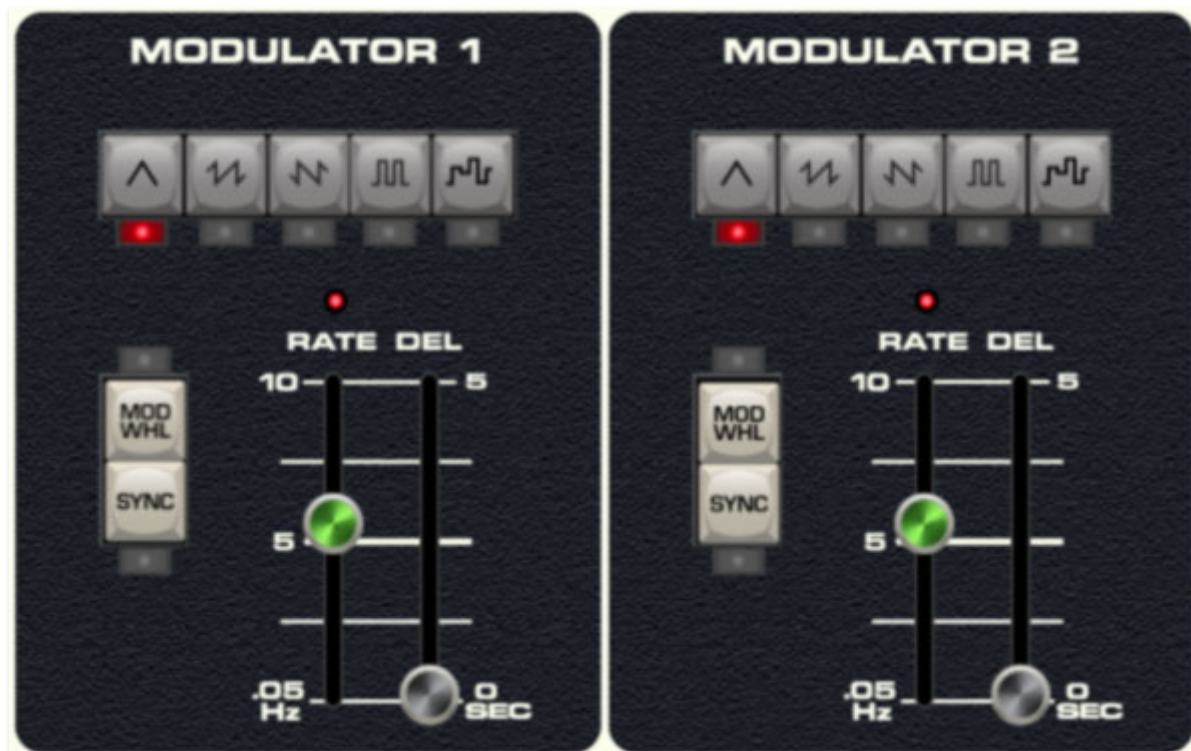

Polymode includes two "bonus" low-frequency oscillators (LFO). These generate sub-audio range signals intended for modulation purposes and are routed to mod destinations via the *Mod Src* buttons and attenuator knobs beneath the main slider controls. For more info, see the Using Mod Sources section.

As both modulators are identical, we'll go over their controls one time. (Feel free to read this twice.)

Mod Wheel - This is a really handy, but potentially confusing feature, so don't skim this section. If the button is in the *Off* position, the LFO is always "on." Its effects will be immediately audible if a *Mod Src* routing is active. Clicking to the *On* position enables control of modulator depth with an external keyboard controller mod wheel. If the mod wheel is all the way down, modulator depth is zero. This makes setting up a mod wheel to add vibrato or wah effects very easy. If it seems like the modulator isn't working, check if the *Mod Wheel* switch is engaged.

Sync- Engaging the *Sync* button locks the LFO master tempo. When engaged, the *Rate* slider snaps to note values ranging from 1/64th note triplet to 8 beats. *Sync* mode locks to the tempo in the top toolbar when

using the Polymode standalone version or the current project tempo when the plug-in version is used in a DAW.

Waveform- Selects the repeating pattern of the modulator. Available waveforms are triangle, ramp, sawtooth, square, and random waves. Only one waveform is available at any time.

Rate- Sets the LFO rate from 0.05 to 10 Hz with *Sync* disabled (i.e. free-run mode). The LED above the slider flashes at the current rate.

Del- Moving this slider up gradually delays the onset of modulator depth. The delay time can be set from 0 to 5 seconds. Note that LFO delay is global, so the modulator delay won't start anew for each note played; the onset delay restarts only when all currently held notes are released.

When the *Mod Wheel* switch is in the on position, the *Delay* slider grays out and is disabled (because you wouldn't want the onset of modulator mod delayed when controlling mod amount with a mod wheel).

Effects

Ensemble

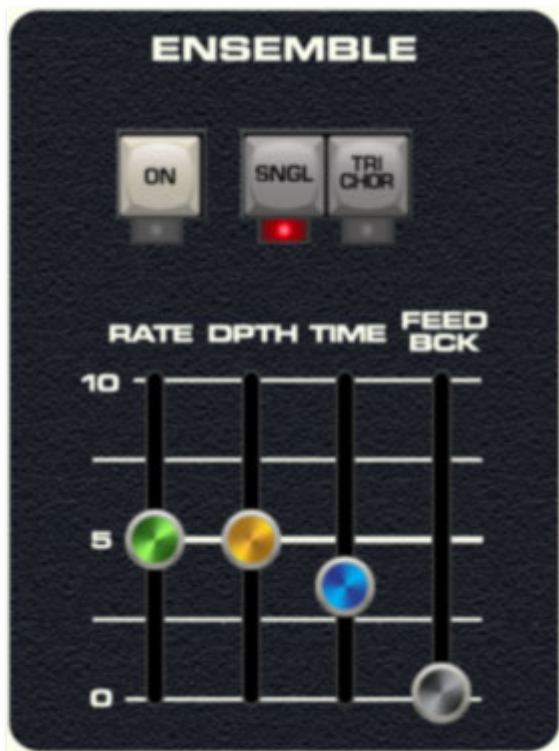

The Ensemble effect is a stereo flanger/chorus with two modes.

On/Off- Enables and disables the Ensemble effect. The LED illuminates when the effect is active.

Single (mingling optional)- This is the standard, single-LFO stereo flanger/chorus that uses an inverted LFO waveform in one of the channels to create its stereo effect. General speaking, setting the *Time* control from 4-12 ms results in flanging-type effects, and longer times result in chorus effects. Turning up the feedback control will emphasize the ringy/jet-plane flanger tone, whereas choruses usually don't utilize any feedback.

Tri Chor- *Tri Chor* mode emulates the chorus effect of the vintage Solina String Synthesizer and other classic string synths. It uses two LFOs running at different speeds to modulate three different delay lines, with each LFO mod source "tapped" at different phases of the LFO wave.

Classic tri-choruses rarely have any user-adjustable controls; this is because their complex modulation scheme need everything set just right, otherwise they can sound like a smeary mess. With this in mind, **selecting**

Polymode's *TriChor* button automatically sets the *Rate* control to 6 Hz, and disables the *Depth*, *Time*, and *Feedback* controls for optimal tri-chorus-errific effect. The *Rate* control may still be manipulated.

The TriChorus' dual LFOs run at default speeds of 6 Hz and 1 Hz respectively. If the *Rate* slider is adjusted in TriChorus mode, the dual LFO rates move in lock step with the slider tooltip displaying the fast LFO speed.

Like the classic string synthesizers it's modeled upon the TriChorus is mono only. This may seem counterintuitive, but stereo-izing a TriChorus doesn't correctly capture the vintage sound. If you must have stereo chorus, *Sngl* mode sounds great... or use the Echo effect with the *Spread* button enabled (or just move your head back and forth really quickly).

Rate- Sets the Ensemble's internal LFO speed.

Depth- Sets the effect depth, i.e. the amount of LFO delay time mod.

Time- Sets the overall delay time. Chorus effects are typically in the 10-20 ms range, faster times from around 2-10 ms are useful for flanger-type sounds.

Feedback- Increasing the amount of feedback intensifies the effect. Chorus effects typically don't use any feedback; flangers almost always use feedback for increased "jet-plane" sound.

Phaser

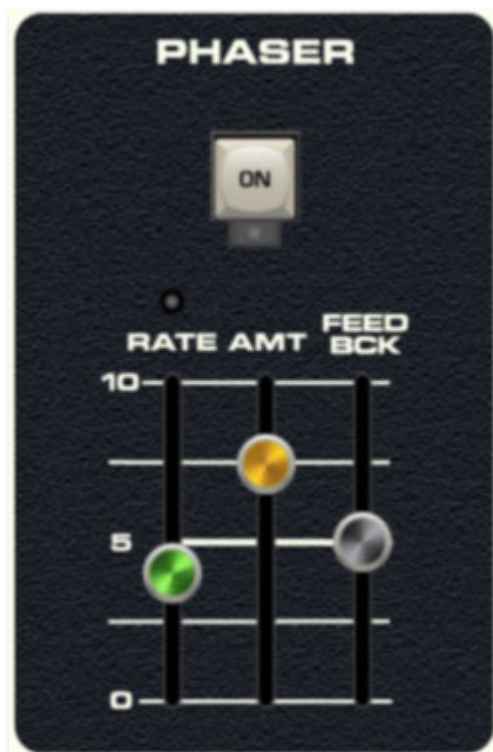

Polymode's phaser is a fat and warbly recreation of the classic phaser stomp boxes of the 70s. But unlike most vintage phasers, it's stereo, that is, its modulation cycles are 180° out of phase for a rich, wide image.

On/Off- Enables and disables the Phaser effect. The LED illuminates when the effect is active.

Amt- Sets the effect depth.

Rate- Sets the phaser's internal LFO speed. The phaser LFO is independent of Polymode's other LFO's.

Feedback- Increasing the amount of feedback intensifies the phasing effect.

Echo



Echo accurately imitates vintage delays and includes master tempo sync, up to two seconds of delay time, and a spread button for stereo imaging.

On/Off- Enables and disables the Echo effect. The LED illuminates when the effect is active.

Time- Sets the delay time from 11-2000 ms.

Sync- Engaging the *Sync* button locks the delays time to master tempo. When engaged, the *Time* slider snaps to note values ranging from 1/64th note triplet to 8 beats. *Sync* mode locks to the tempo in the top toolbar when

using the standalone version of Polymode, or the current project tempo when the plug-in version is used in a DAW.

Spread- This subtracts 10 ms from the left channel and adds 10 ms to the right channel delay times, creating a wide stereo effect, and it prevents the echoes from "piling" up in the center of the image. Note that the subtracted and added delay effectively changes the overall delay time setting with each repeat, so long delays combined with high feedback settings can become noticeably off time. This can be circumvented by disabling the *Spread* control.

Feedback- Routes the output to the input for additional repeats. Be careful at high settings as this can result in runaway feedback madness.

Dmp (Damp)- Attenuates high frequencies as the slider amount is increased. Not only does this create more natural sounding decays, it also reduces the "stacking" effect that occurs with high feedback levels.

Mix- Balances the level of dry and wet signal.

Reverb



On/Off- Enables and disables the reverb effect. The LED illuminates when the effect is active

Reverb Type - Room/Plate/Hall- Allows selection of three different types of reverb.

Decay- Sets the overall length of reverb; actual times vary dependent on the reverb type.

Dmp (Damp)- Attenuates high frequencies as the slider amount is increased for more natural reverb sounds.

Mix- Balances the level of dry and wet signal.

Master Controls



Mast Tune- Sets master tuning up or down by just over a minor third.

Pitch Bend- Sets incoming pitch bend range from zero to one octave, up or down.



Master Out- Sets Polymode's master volume. This setting is saved with individual patches

Output Meters- Not really a control, these display the master output level. Like any other meter, it's best to keep these out of the red.

Using Mod Sources



The original instrument had no user-configurable mod routing to speak of - all of its mod routings were fixed. It compensated for this shortcoming by including four LFO's, but still was fairly limited on the modulation front. Polymode improves upon modulation flexibility in two ways - we added two additional dedicated LFOs (for Rank 2 pulse-width modulation, and global mod of all three of the Resonators' cutoff frequencies), and significantly, we've added user-configurable mod assignments to almost every one of Polymode's variable synthesis parameters. Best of all, Polymode's mod assignments are super easy to use. Here's how they work:

The *Mod Src* selector buttons and attenuators beneath the sliders allow positive or inverted voltage control of the slider directly above via the selected mod source. Clicking the *Mod Src* selector button opens a pop-up menu where the mod source can be selected. Once a mod source is chosen, the button turns red and its label changes to indicate the current mod source. To choose a different mod source, click the button and choose another modulator, or choose *None* to disable modulation. The attenuator knobs beneath the *Mod Src* buttons set a positive or inverted voltage control amount for the controls, with center position representing zero modulation.

Note that the effect of incoming mod CV's is directly related to the current control position. For example, if the cutoff slider is currently set to fully open

position, adding positive modulation will have no effect. In other words, modulation CV's can only alter a control setting within its inherent minimum and maximum settings.

Following is a list of all mod sources:

- **None:** No mod source.
- **Modulator 1:** The first LFO in the bottom section of the panel.
- **Modulator 2:** The second LFO in the bottom section of the panel.
- **VCF Envelope:** VCF envelope at the bottom of the panel. Keep in mind that the VCF envelope (as well as the VCF) is paraphonic; that is there is only one for the entire instrument, so it won't individually articulate for each note, but it does retrigger any time a key is pressed.
- **Amp Envelope:** Amp envelope at the bottom of the panel. Unlike the VCF envelope, each note of polyphony has its own independent envelope generator.
- **Keyb CV:** Generates a CV that rises as the keyboard is ascended. This a single voltage that "holds" at whatever CV was generated by the most recently played key. Try assigning *Keyb CV* to *VCF Freq* slider and raising the Master Gain *VCF* slider to clearly hear its effect.
- **Velocity:** Generates a CV that changes depending on how hard the most recently played key was struck. Like *Keyb CV*, this is a single voltage that "holds" at its most recent value.
- **Pitch Bend:** Generates a positive or negative CV depending on which way a MIDI pitch bender is moved.
- **Mod Whl:** Generates a CV proportional to MIDI mod wheel movement.
- **Channel Pressure (Aftertouch):** Generates a CV from keyboard aftertouch. (mono only)
- **White Noise:** Though it doesn't appear on the panel, we hid a noise generator in Polymode as a mod source. Though it can't be used directly as an audio source, it's useful as mod source and works particularly for sound effects when routed to the Rank *Tune* sliders and *VCF Freq* slider.
- **Pink Noise:** Similar to white noise, but with a slightly bassier frequency spectrum.
- **DC Source:** This is a fixed voltage source that can be positive or negative dependent upon attenuator setting. This can be used to fully "open up"

the VCF cutoff frequency. It's also useful for extending the mod depth of the Rank *FM Amt* sliders.

MIDI Controllers Setup and The MIDI Tab

Assigning internal and external hardware controls adds a whole new dimension of control and musicality to patches, and it's really easy to do. The MIDI Tab is where all controller assignments can be viewed and tweaked. First we'll show how to assign an external hardware controller to a Polymode control, then we'll go over all parameters in the MIDI Tab.

Basic External Hardware Control Assignment

This is the quick, "I just want to assign a hardware control right now!," section. We recommend reading this whole section to best take advantage of Polymode's swift MIDI control assignments.

In this example, we'll assign a hardware slider control to the VCF section *Cutoff* frequency. Make sure you have the *VCF* slider turned up in the Master Gain section at left.



Begin by right-clicking on the *Freq* slider in the *VCF* section and selecting *MIDI Learn*. A transparent purple overlay appears over the slider indicating that it's in learn mode. Now move the desired hardware control device. The purple overlay disappears and the hardware control will move the onscreen slider. If you get cold feet (or accidentally put the wrong control into learn mode), learn mode can be aborted by right-clicking and selecting *Stop Learning*.

This is the basic procedure for assigning hardware controllers to any Polymode control.

When in MIDI learn mode, any previously assigned controller numbers will show in squares. These indicate the MIDI continuous controller number of the assigned hardware control (these are also displayed in the *MIDI* library tab at left).

Once a MIDI controller has been assigned, in addition to real-time control of a Polymode parameter, you'll also be able to record and play back controller data from a DAW.

The MIDI Tab

This is command central for all MIDI controller assignments. Here you'll be able to see information about all currently assigned controllers and adjust control ranges.



To view or hide the MIDI Tab, click the *MIDI* button in the top toolbar.



MIDI Learn button- This is almost exactly the same as enabling MIDI learn mode by right-clicking a control. Click the *MIDI Learn* button to enter learn mode (all controls turn purple). Unlike right-clicking on specific knobs, where Polymode automatically exits controller assignment mode, clicking the *MIDI Learn* knob "stays on" to enable assignment of multiple hardware controls.

This is handy for quickly assigning a bunch of sliders or the buttons of a grid-style controller.

To assign multiple controls, click *MIDI Learn*, click an on-screen control, move the desired hardware knob or slider, continue clicking and assigning on-screen controllers until all desired controls are assigned, then click *Stop Learning* to exit learn mode.

Remember that a single hardware knob/slider/button isn't limited to controlling just one parameter - a single hardware controller can simultaneously operate as many controls as you'd like.

MIDI Tab Columns

Name- Displays the name of the parameter being controlled.

Type- There are five possible types of controller automation in Polymode:

- *Note*- Notes played on a MIDI keyboard controller, expressed as C-1 to G9
- *CC (MIDI Continuous Controller)*- The standard 128 MIDI controller numbers as defined in the MIDI spec. More specifically, these are the controllers transmitted by hardware knob and slider controls. MIDI CC's can be used to control parameters in real-time or recorded and played back within DAW software.
- *MMC (MIDI Machine Control)*- The MIDI control protocol for tape machine-style transport controls. Back in the dark ages, this was used to control wonky old Tascam and Fostex reel-to-reel monsters, but it's useful if your MIDI controller has tape-style transport control buttons.
- *Pressure*- Some keyboard controllers transmit controller data when keys are pressed and released as they're held down; this also known as "aftertouch." The vast majority of keyboard controllers with aftertouch transmit "mono" aftertouch only; in other words, aftertouch data is the sum of all held keys to one single data stream.
- *Key*- This allows keys of the computer QWERTY keyboard to act as button controls for Polymode's onscreen controls.

Value- Displays the specific automation controller. In the case of a *Note* this would show a MIDI note number (C-1 to G9, for a MIDI CC, this would be the MIDI CC controller number, etc. Clicking on the value opens a pop-up menu where all values are displayed and can be selected.

Min- Sets a limit on the lowest value any automation control can set a mapped controller to. This actually recalibrates the range of the automation

controller to the remaining parameter range.

Max- Sets a limit on the highest value any automation control can set a mapped controller to. This actually recalibrates the range of the automation controller to the remaining parameter range.

- **Super Tricky Min-Max Tricks**- Not only can parameter ranges be limited via the the *Min* and *Max* knobs, mapped control destinations can be completely inverted by setting the *Min* knob all the way up and the *Max* knob all the way down (or anywhere in between).

Limiting and inverting parameter ranges with the *Min/Max* controls is particularly useful when multiplexing a single hardware control to operate multiple parameters. Along with the *Curve* control, the customization possibilities are super flexible.

Curve- These allow the customization of how incoming MIDI CC controls affect the movement of Polymode's onscreen controls, ranging from exponential to linear to logarithmic curves.

MIDI Tab Column Configuration Right-Click Menus

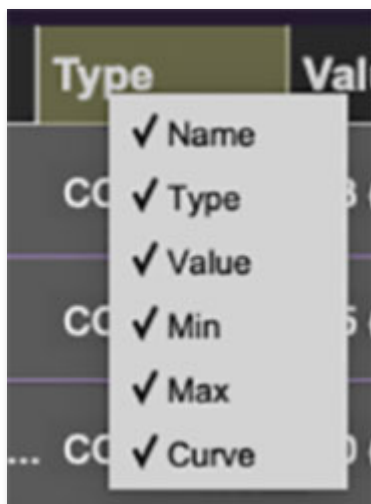

Right-clicking anywhere in the top row (*Name*, *Type*, *Value*, etc.) displays the column configuration menu. Checking/unchecking these allows hiding and display of each column. This has no effect on assignments.

MIDI Tab Parameters Right-Click



Right-clicking on an assigned parameter opens the menu above.

MIDI Learn- This is used to change the controller assigned to a particular parameter.

Unlearn- Deletes the selected automation parameter.

Unlearn All- Deletes all controller assignments for the patch. Polymode will display a warning dialog prior to deletion in order to thwart potential unlearn-related disasters.

QWERTY Musical Typing Keyboard (MTK)

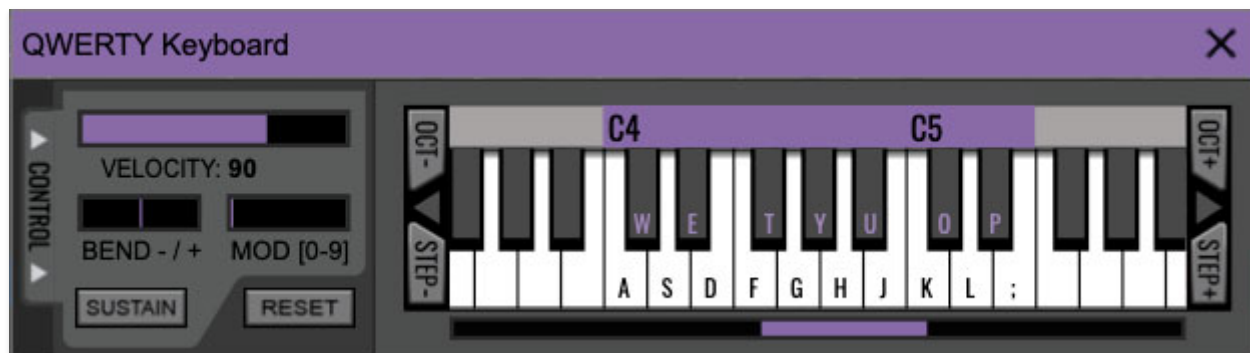

If you don't have a MIDI keyboard attached to your computer, the standard QWERTY computer keyboard can be used to play notes - we're pretty sure you've got one of those! We'll refer to this as the "MTK." Following is a list of MTK keyboard modifiers and functions:

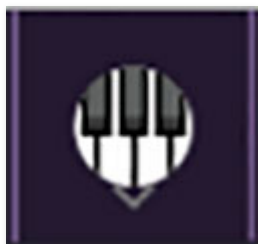

Opening and Closing the MTK - Click the the circular keyboard icon in the top toolbar. To close the MTK, click the keyboard icon in the top toolbar, or click the X in the top-right corner.

Play Notes- To trigger notes, simply press the corresponding computer keyboard key or mouse click the onscreen keys.

Adjust Currently Visible MTK Range- Slide the purple scroll bar horizontally to adjust the currently visible keyboard range.

Adjust Overall Visible Keyboard Range- Clicking and dragging the right edge of the MTK window allows the overall size of the window to be adjusted. This lets you view more or less of the onscreen keyboard. Note that the MTK window's borders cannot exceed the overall outside dimensions of the Polymode window.

Shift Range Up/Down Octave- Click the *Oct-* and *Oct+* buttons at the top left and right of the onscreen MTK. The current range is displayed above the keyboard.

Shift Range Up/Down Semitone- Click the *Step-* and *Step+* buttons at the bottom left and right of the onscreen MTK. The current range is displayed above the keyboard.

Hide/View Controllers- Clicking *Control* at the far left hides and displays velocity, bender, mod, and sustain control parameters. Hiding the control view makes more space available for the keyboard.

Set Note Velocity- Move the purple *Velocity* bar to adjust the output velocity of notes. This will only be audible if the *Vel* slider in the Amp Env section is raised, or velocity is assigned to modulate a parameter via one of the *Mod Src* selector buttons.

Pitch Bend- To pitch a note or notes, press the + or - computer keyboard keys while playing a note. Notes will bend up to an octave. Notes can also be pitchbent by clicking the mouse in the *Bend* area.

Mod Wheel- To add mod wheel modulation, press the number keys from 0-9 (above the character keys) while playing a note. The modulation amount will vary from none (0) to full modulation (9). Note that modulation will "stick" at the selected number; to disable modulation, click the 0 key. Mod can also be engaged by clicking the mouse in the mod bar area.

Sustain- The *Sustain* button mimics the functionality of a standard sustain pedal. Click the [TAB] key to engage sustain, or [SHIFT]+[TAB] to lock it. The *Sustain* button can also be engaged by mouse clicking it. Finally, the soft drink *Tab* cannot be consumed while using the MTK, as it was discontinued in 2020, but it had a good run.

Reset- Initializes all MTK parameters including keyboard range and control parameters.

Settings

Clicking the settings gear opens a window with multiple tabs for configuring various "under-the-hood" settings. These are mostly set-and-forget kind of parameters - all the stuff you'll want to tweak is on the front panel, where it should be!

General

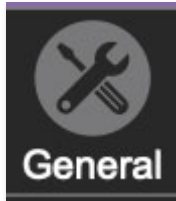

- **Add Undo For Control Changes With The Mouse**- Enabling this allows undo of knob/slider/button adjustments. You'll want this on if you want the ability to undo all aspects of patch editing and programming.
- **Load Last Preset On Startup (Standalone Only)**- Automatically loads the last preset used when DCO-106 standalone version is started.
- **Create A Log File For Usage**- This creates a text doc of all of Polymode's internal and routines during use. It is mainly intended for our tech staff should you experience any issues. Clicking *Show Log Folder* opens the folder containing Polymode log file docs.
- **Preset Folder**- Displays the current location of Polymode's sound presets. This can be changed by clicking and typing in the field.
 - **Browse...** - Displays the current location of preset folder in the file manager.
 - **Set Default**- Sets the current displayed *Preset Folder* path as the default location
- **Clear Cache Files**- Deletes all log files, temporary sounds, and the image cache.



Interface

Allows customization of Polymode's user interface settings.

- **Reset To Default Window Size-** Resets the Polymode workspace to 100%. Use this to reset the window size if Polymode's workspace somehow becomes too large for your display and can't be resized.
- **Tooltip Delay-** Tooltips are those informative bits of text that pop up when hovering over a control (go ahead and try it, we'll wait...). The *Tooltip Delay* setting defines how long you must hover before the tooltip pops up.
- **Knob Movement-** Defines which how mouse movements related to turning onscreen knobs. It defaults to *Vertical Drag*, but can be changed to *Horizontal Drag*, or *Rotary Drag*. While we're on the subject, my buddy Eric's old band *Imperial Drag* is pretty rad.
- **On Control Double-Click-** Defines what happens when the mouse is double-clicked on a control. If *Edit Value* is selected, an exact number can be entered by typing the number and hitting [ENTER] or [RETURN]. If *Sets Default Value* is selected, double-clicking a control resets it to its default value.
- **Mouse Wheel Adjusts Control Value-** Enabling this lets you adjust knob, slider, and switch values by moving the mouse wheel. This works great with a standard mouse wheel, but you'll want to disable it if you're using an Apple Magic Mouse (which will move the control AND scroll the window).
- **Show Tooltips When Adjusting Controls With Mouse-** Displays parameter tooltips/values when the mouse is hovered over a control or as a control is moved with mouse clicked.
- **Show Tooltips When Audotmating Controls-** Displays parameter tooltips/values next to controls any time a control is changed, i.e. if a control is moved via an assigned MIDI controller or a *Perform* panel knob, etc.
- **MIDI Program Changes Should Change Current Preset-** Allows MIDI program change messages to change Polymode patches.
- **Ask To Save Modified Presets-** This opens a dialog window asking if you'd like to save changes if a patch has been edited and a new patch is selected. If you're the type that likes to click through presets and tweak a control here and there, it can be annoying to have a window pop-up

asking if you'd like to save every time you switch presets - if you're that person, keep this off.

- **Remember MIDI Mappings For New Plug-in Instances-** When enabled, Polymode remembers all MIDI Tab controller settings.

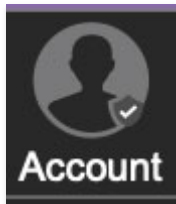

Account

Settings for your personal login information and account.

- **Email-** Displays the email address of the current login.
- **Update Login Info-** No, this isn't a place for news and tour dates for yacht rock superstar, Kenny Loggins. Clicking this opens the same email and password login screen you'll see when initially launching Polymode.
- **View Account Settings-** This opens your personal account page on the Cherry Audio Store website containing information about modules purchased and more.

Software Update

- We often fix bugs and make improvements; below are options defining how Polymode handles updates.
- **Check For Update-** Click this to see if an updated version of Polymode available.

Status-

- **Automatically Install Updates-** Updates are automatically downloaded and installed.
- **Ask Before Installing Updates-** By default, Polymode automatically downloads new versions of modules when available. Checking this box defeats automatic updates and will ask if you'd like to install updates when they become available.

We'll never make changes that can potentially "break" existing patches

but we recommend enabling *Ask Before Installing Updates* if you're using Polymode for live performances or other "mission critical" situations.

- **Never Install Updates**- Polymode never automatically installs updates.
- **Show Updates On Toolbar**- Checking this will display an icon in the toolbar next to the logo letting you know there's an update available.

Show Notifications From Cherry Audio- We occasionally will send in-app advertisements; disabling this checkbox will hide them. We hate repetitive, annoying ads as much as you do, so we don't use this feature often. Rest assured, when we do, it'll be for something super cool (like a killer sale), so we recommend leaving it on.



Audio/MIDI

Settings for audio and MIDI hardware input and output. **This tab is only visible in the standalone version of Polymode.**

- **Output**- Use this drop-down menu to choose a physical audio output source. This defaults to *Built-In Line Output*, i.e. your computer's onboard system audio, but you'll get better fidelity with an external professional audio interface. The biggest audible difference is usually reduced background noise or hum, but external audio hardware also offers greater flexibility in terms of number of inputs and outputs and built-in mic or low-level instruments pres (i.e. electric guitars). These are especially useful if you're using Polymode's external inputs to process sound. The *Test* button will produce a sine wave when clicked; this will help with troubleshooting, aka, "WHY THE HECK ISN'T THIS MAKING ANY NOISE?!?"
- **Sample Rate**- This sets Polymode's global sample rate. Lower sample rates offer better performance, but if you have a fast computer, high sample rates may offer slightly improved fidelity.
- **Audio Buffer Size**- As with any digital audio app, this defines performance vs. note latency, and will largely depend upon computer CPU speed. A professional external audio interface will almost always exhibit

better performance than “built-in” system audio. Lower settings will result in less latency (in the form of faster response to notes played), but will increase the chances of audio gapping or crackling noise.

- **Active MIDI Inputs**- Displays all available MIDI input sources, i.e. keyboards, pad controls, MIDI knob/fader control surfaces, etc. Check boxes to enable one or more devices.