

 **BOSS**

**RRV-10**

**DIGITAL REVERB**

**INSTRUCTIONS**

The RRV-10, equipped with the BOSS original DSP (Digital Signal Processor), is compact, yet a high quality reverb unit with good sound quality and various functions.

## FEATURES

- The RRV-10 includes nine different types of ambient environments.
- The reverberation (decay) time or the gate time is continuously variable, therefore fine adjustment is possible.
- The Pre-equalizer section can widely control the tone of the reverb sound.
- Equipped with the Stereo Outputs, the RRV-10 can produce extremely fat reverb sounds.
- The RRV-10's noise reduction circuits achieve residual noise of lower than - 100dBm (IHF-A).
- The unique Input Cancelling System allows to turn the unit off without killing reverb sounds.

## CONTENTS

|                           |    |
|---------------------------|----|
| 1 Panel Description ..... | 3  |
| 2 Connection .....        | 5  |
| 3 Operation .....         | 6  |
| 4 Example Settings .....  | 8  |
| 5 Important Notes .....   | 10 |
| 6 Specifications .....    | 11 |

## RADIO AND TELEVISION INTERFERENCE

**Warning** - This equipment has been verified to comply with the limits for a Class B computing device, pursuant to Subpart J, of Part 15, of FCC rules. Operation with non-certified or non-verified equipment is likely to result in interference to radio and TV reception.

The equipment described in this manual generates and uses radio-frequency energy. If it is not installed and used properly, that is, in strict accordance with our instructions, it may cause interference with radio and television reception.

This equipment has been tested and found to comply with the limits for a Class B computing device in accordance with the specifications in Subpart J, of Part 15, of FCC Rules. These rules are designed to provide reasonable protection against such a interference in a residential installation. However, there is no guarantee that the interference will not occur in a particular installation. If this equipment does cause interference to radio or television reception, which can be determined by turning the equipment on and off, the user is encouraged to try to correct the interference by the following measure:

- Disconnect other devices and their input/output cables one at a time. If the interference stops, it is caused by either the other device or its I/O cable.

These devices usually require Roland designated shielded I/O cables. For Roland devices, you can obtain the proper shielded cable from your dealer. For non Roland devices, contact the manufacturer or dealer for assistance.

If your equipment does cause interference to radio or television reception, you can try to correct the interference by using one or more of the following measures:

- Turn the TV or radio antenna until the interferences stops.
- Move the equipment to one side or the other of the TV or radio.
- Move the equipment farther away from the TV or radio.
- Plug the equipment into an outlet that is on a different circuit than the TV or radio. (That is, make certain the equipment and the radio or television set are on circuits controlled by different circuit breakers or fuses.)
- Consider installing a rooftop television antenna with coaxial cable lead-in between the antenna and TV.

If necessary, you should consult your dealer or an experienced radio/television technician for additional suggestions. You may find helpful the following booklet prepared by the Federal Communications Commission:

"How to Identify and Resolve Radio-TV Interference Problems"  
This booklet is available from the U.S. Government Printing Office, Washington, D.C., 20402. Stock No. 004-000-00345-4.

### Bescheinigung des Herstellers/Importeurs

Hiermit wird bescheinigt, daß der/die/das

• **BOSS DIGITAL REVERB RRV-10**

(Gerät Typ Bezeichnung)

in Übereinstimmung mit den Bestimmungen der

**Amtsbl. Vfg 1046 / 1984**

(Amtsblätverfügung)

funk-enstort ist.

Der Deutschen Bundespost wurde das Inverkehrbringen dieses Gerätes angezeigt und die Berechtigung zur Überprüfung der Sene auf Einhaltung der Bestimmungen eingeräumt

**Roland Corporation Osaka/Japan**

Name des Herstellers/Importeurs

# 1 PANEL DESCRIPTION

## «Front Panel»

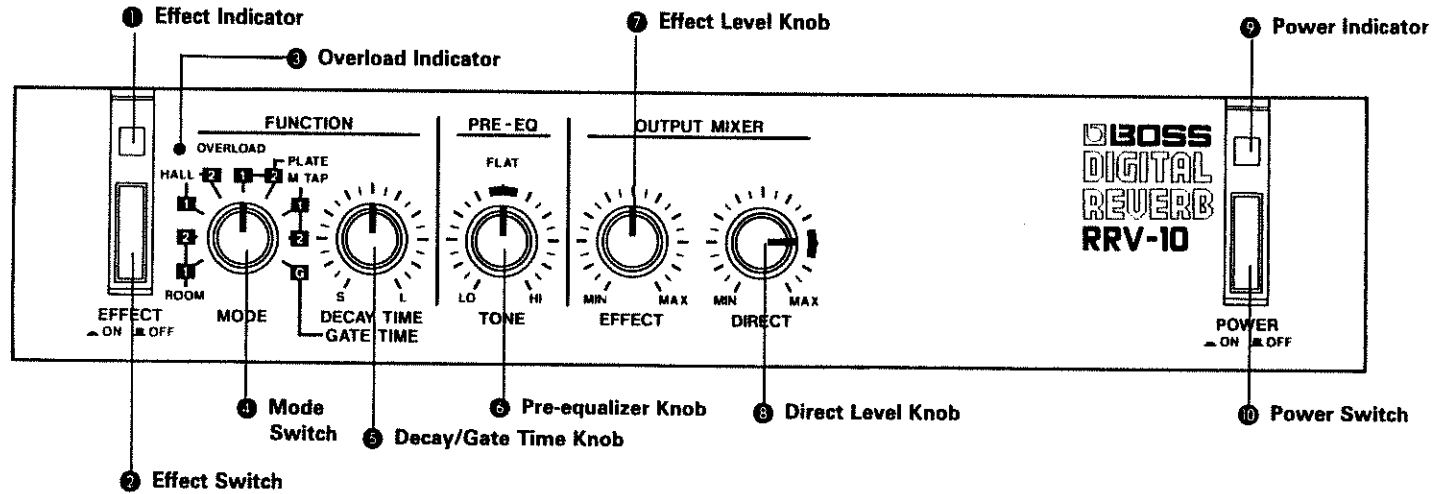

## «Rear Panel»

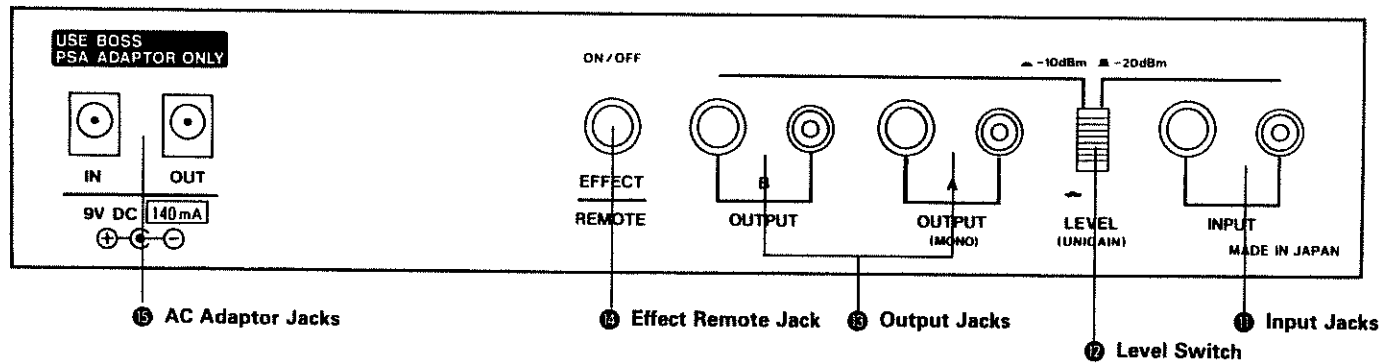

**1 EFFECT INDICATOR**

This lights up when the effect is turned on.

**2 EFFECT SWITCH**

Pushing this switch turns the effect on, and pushing it again turns the effect off.

\* Even when the effect is turned off, the reverb sound does not stop immediately but remains for a while, giving a natural decaying impression.

**3 OVERLOAD INDICATOR**

This lights up when excessive signal is fed into the unit.

**4 MODE SWITCH**

**5 DECAY/GATE TIME KNOB**

**6 PRE-EQUALIZER KNOB**

**7 EFFECT LEVEL KNOB**

**8 DIRECT LEVEL KNOB**

} See "OPERATION"

**9 POWER INDICATOR**

This lights up when the unit is turned on.

**10 POWER SWITCH**

This turns the unit on or off.

\* For about ten seconds after the unit is turned on, it does not work.

**11 INPUT JACKS**

Connect a musical instrument or audio equipment to this jack.

\* These are two input jacks; standard phone and pin, but they cannot be used at the same time. If both are connected, the standard phone jack will have priority.

**12 LEVEL SWITCH** ————— See "OPERATION"

**13 OUTPUT JACKS**

Through these jacks, the effect (or normal) sound is sent out.

\* Both the standard phone and the pin jacks can be simultaneously used.

\* For monaural connection, use the Output Jacks A only.

**14 EFFECT REMOTE JACK**

By connecting the Foot Switch FS-1 or FS-5L (both optional), to this jack, you can turn the effect on or off by pressing the pedal.

\* Before using this function, be sure to turn on the Effect Switch on the front panel.

**15 AC ADAPTOR JACKS**

The "IN" jack is to connect an AC adaptor (BOSS PSA-120,220 or 240) or the Power Supply (BOSS RPW-7). Connect the plug of the AC adaptor or the Power Supply to "IN". To supply power to other BOSS Micro Studio Series, connect the supplied DC cord to "OUT".

\* When using the PSA adaptor, please be sure that the total current draw does not exceed 200mA, and when using the RPW-7, 700mA. (The current draw of each unit is shown on its rear panel.)

## 2 CONNECTION

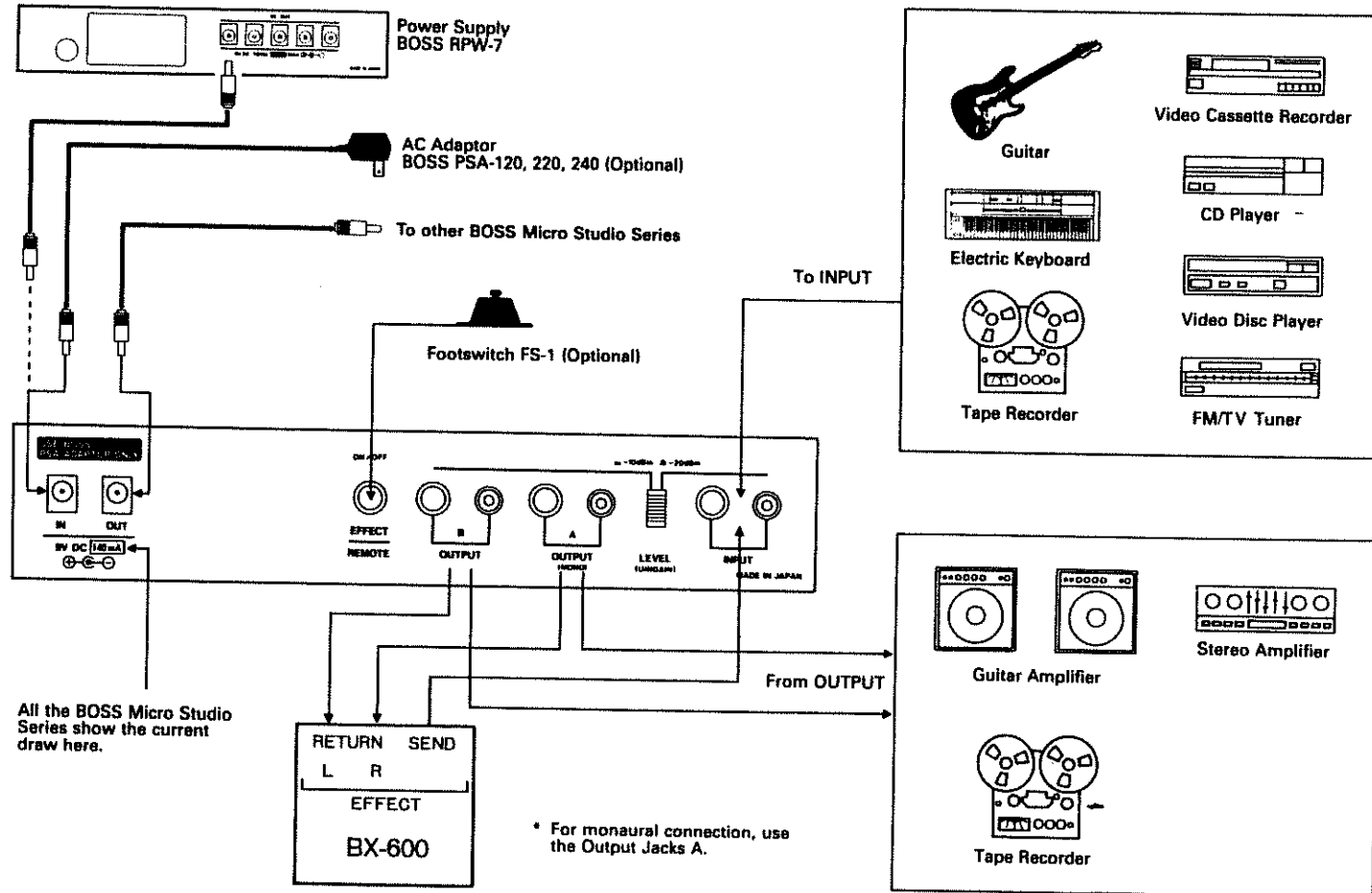

### 3 OPERATION

- ① Set the controls on the panel as shown below.

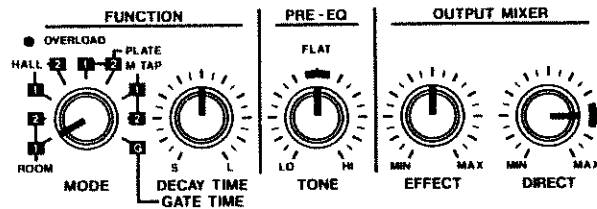

- ② Set the Level Switch ⑫ to the appropriate position depending on the type of the unit used.
- \* "-20dBm" position gives less noise, but if the sound is distorted or the Overload Indicator ⑬ lights up frequently, change it to "-10dBm".
  - \* The position of the Level Switch does not affect the volume of the sound.



LEVEL (UNIGAIN)

- ③ Select the desired reverberation (ambient environment) with the Mode Switch ④.

\* If you rotate this knob while actually listening to the sound, noise may be heard, but there is nothing to worry about it.

- ROOM 1 (Small)
- ROOM 2 (Large)
- HALL 1 (Small)
- HALL 2 (Large)
- PLATE 1
- PLATE 2
- MULTI TAP 1 (Delay)
- MULTI TAP 2 (Reverse)
- Gated Reverb

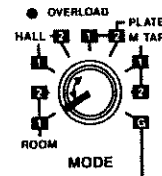

- ④ With the Decay/Gate Time Knob ⑤, set the decay time of the reverberation (or the gate time of the gated reverberation). Rotating the knob clockwise makes longer time.

\* If you rotate this knob while actually listening to the sound, noise may be heard, but there is nothing to worry about it.



- ⑤ Using the Pre-equalizer Knob ⑥, make the desired tone. Rotating the knob clockwise cuts the lower frequency, creating brighter sound, and rotating it counterclockwise cuts the higher frequency creating warmer sound.

\* The equlizer does not work on the direct (normal) sound.



- ⑥ With the Effect Level Knob ⑦, adjust the volume of the effect sound. Rotating the knob clockwise increases the volume.



- ⑦ With the Direct Level Knob ⑧, adjust the volume of the direct (normal) sound. Rotating the knob clockwise increases the volume, and at the marked position, the input and the output levels are equal.

\* This knob works in both Effect ON or OFF mode.



## 4 EXAMPLE SETTINGS

### 1) LIVE HOUSE

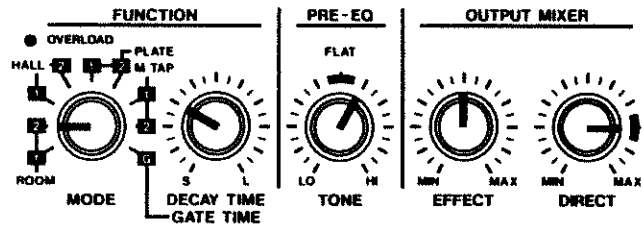

### 2) SMALL HALL

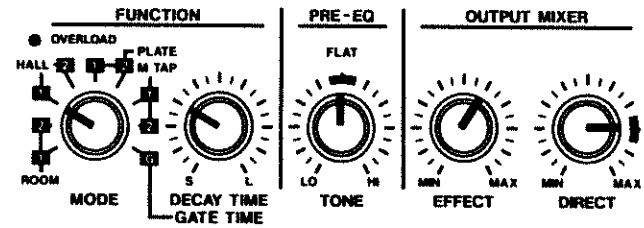

### 3) LARGE HALL

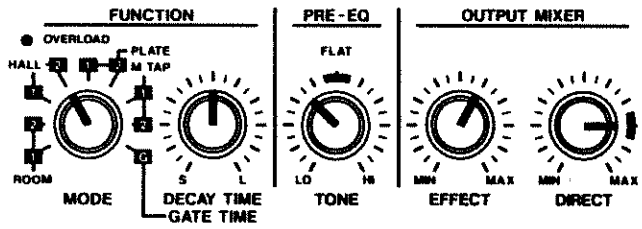

### 4) VOCAL

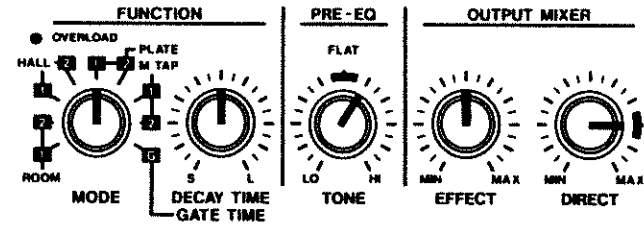



# Setting Memo

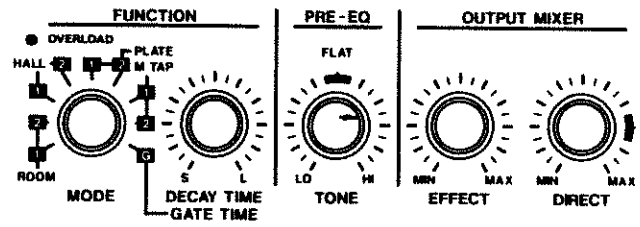
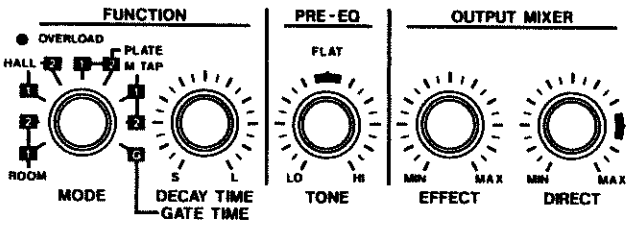
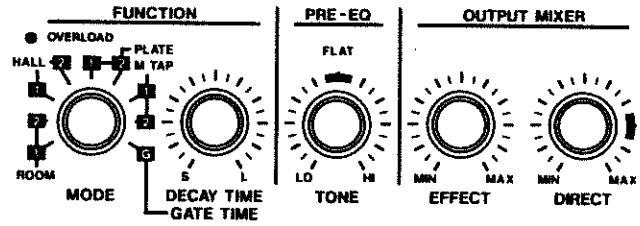
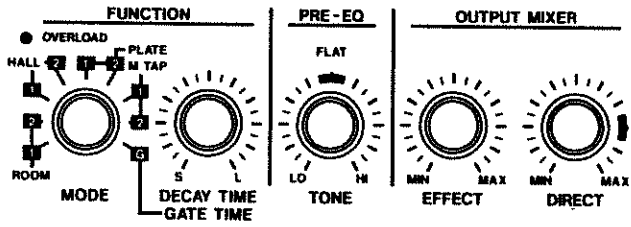
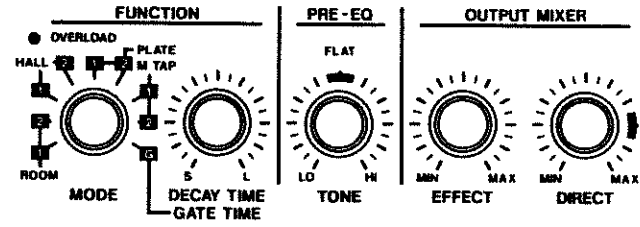
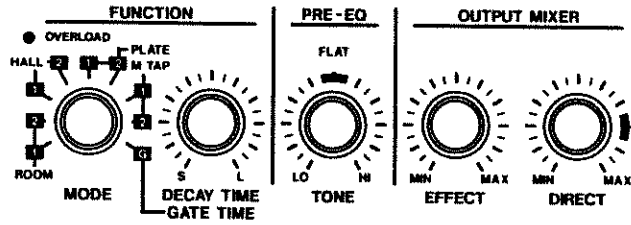

## 5 NOTES

- For about 10 seconds after the unit is turned on, it does not function because of the muting circuit.
- When you are using only one AC adaptor for supplying power to more than one unit, please be sure that the total current draw does not exceed 200mA.
- When the unit is not to be used, disconnect the AC adaptor from the socket.
- Avoid using the unit in excessive heat or humidity or where it may be affected by dust.
- Please never remove the cabinet from the unit.
- When you use the unit on its own without using the optional Rack Mount Adaptor RAD-10, please attach the rubber feet as shown below.

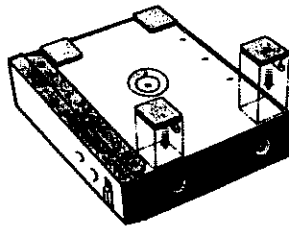

### ■ AC Adaptor, Power Supply BOSS PSA-120, 220 or 240 (optional) BOSS RPW-7 (optional)

Be sure to use the above AC adaptor or power supply. Using any other adaptor or power supply will cause trouble.

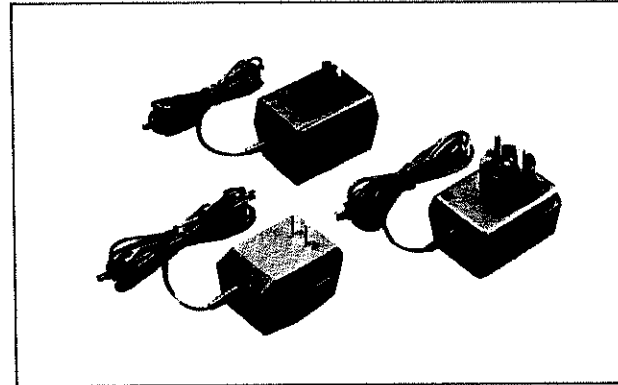

### ■ RACK MOUNTING

The RRV-10 is one of the BOSS Micro Studio Series, and any two of the series can be mounted in a standard 19" rack (EIA-1U) by using the optional Rack Mount Adaptor RAD-10.

Remove the rubber feet from the bottom of the units, fix the units on the Rack Mount Adaptor with the supplied screws, then place the whole set on the rack.

## 6 SPECIFICATIONS

### Input Level/Input Impedance

–20dBm/1M $\Omega$ , –10dBm/47k $\Omega$

### Output Level/Output Impedance

–20dBm/2k $\Omega$ , –10dBm/2k $\Omega$

### Output Load Impedance

More than 10k $\Omega$

### Frequency Response

Direct: 10Hz to 30kHz ( $\pm 1$ dB)

Effect: 30Hz to 10kHz ( $+1$ dB)

### Sampling Frequency

31.25kHz

### Sampling System

12 bit quantizing and analog  
logarithmic compression system  
16 bit internal arithmetic

### Residual Noise

Less than –100dBm (IHF-A, Level Switch at –20dBm)

### Controls

Decay/Gate Time  
Pre-equalizer  
Effect Level  
Direct Level

### Switches

Mode (9 positions)  
Effect (ON/OFF)  
Level (–20dBm/–10dBm)  
Power (ON/OFF)

### Indicators

Power  
Effect  
Overload

### Jacks

Inputs (standard phone, pin)  
Output A (standard phone, pin)  
Output B (standard phone, pin)  
Effect Remote (ON/OFF)

**Power** 9V DC (BOSS PSA-120, 220 or 240, RPW-7)

**Current Draw** 140mA

**Dimensions** 218 (W)  $\times$  169 (D)  $\times$  44 (H) mm/  
8 $\frac{9}{16}$ "  $\times$  6 $\frac{11}{16}$ "  $\times$  1 $\frac{3}{4}$ " inch

**Weight** 900g/2 lb

**Accessories** DC cord (0.5m), Rubber Feet ( $\times 4$ )

### OPTIONS

AC Adaptor BOSS PSA-120, 220 or 240

Foot Switch FS-1, FS-5L

Rack Mount Adaptor RAD-10

Power Supply RPW-7

\*Specifications are subject to change without notice.

 Roland®  
2603088700

UPC 2603088700



1991

 **BOSS**

Products of Roland

RRV-10 Instructions Printed in Japan Feb. '87 C-3

**RRV-10**