

V-VERB PRO

REV2496

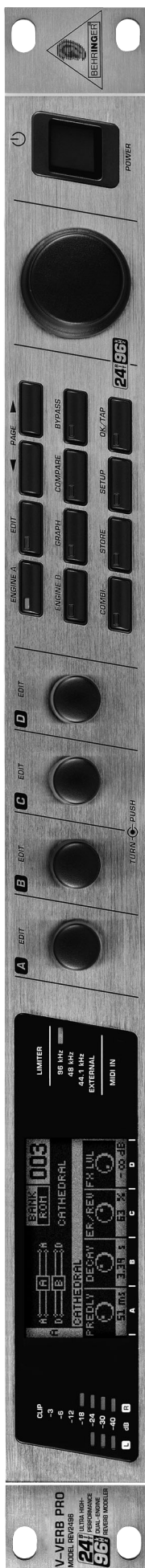

User's Manual

Version 1.0 November 2003

ENGLISH

www.behringer.com



V-VERB PRO REV2496

IMPORTANT SAFETY INSTRUCTIONS



CAUTION: To reduce the risk of electric shock, do not remove the top cover (or the rear section). No user-serviceable parts inside; refer servicing to qualified personnel.

WARNING: To reduce the risk of fire or electric shock, do not expose this appliance to rain and moisture.



This symbol, wherever it appears, alerts you to the presence of uninsulated dangerous voltage inside the enclosure—voltage that may be sufficient to constitute a risk of shock.



This symbol, wherever it appears, alerts you to important operating and maintenance instructions in the accompanying literature. Please read the manual.

DETAILED SAFETY INSTRUCTIONS:

- 1) Read these instructions.
 - 2) Keep these instructions.
 - 3) Heed all warnings.
 - 4) Follow all instructions.
 - 5) Do not use this device near water.
 - 6) Clean only with a dry cloth.
 - 7) Do not block any ventilation openings. Install in accordance with the manufacturer's instructions.
 - 8) Do not install near any heat sources such as radiators, heat registers, stoves, or other apparatus (including amplifiers) that produce heat.
 - 9) Do not defeat the safety purpose of the polarized or grounding-type plug. A polarized plug has two blades with one wider than the other. A grounding type plug has two blades and a third grounding prong. The wide blade or the third prong are provided for your safety. If the provided plug does not fit into your outlet, consult an electrician for replacement of the obsolete outlet.
 - 10) Protect the power cord from being walked on or pinched particularly at plugs, extension cords, and the point at which they exit the unit.
 - 11) Only use attachments/accessories specified by the manufacturer.
 - 12) Use only with the cart, stand, tripod, bracket, or table specified by the manufacturer, or sold with the device. When a cart is used, use caution when moving the cart/device combination to avoid injury from stumbling over it.
- 
- 13) Unplug this device during lightning storms or when not used for long periods of time.
 - 14) Refer all servicing to qualified service personnel. Servicing is required when the unit has been damaged in any way, such as power supply cord or plug is damaged, liquid has been spilled or objects have fallen into the device, the unit has been exposed to rain or moisture, does not operate normally, or has been dropped.

V-VERB PRO

Ultra High-Performance 24-Bit/96 kHz Dual-Engine Reverb Modeler

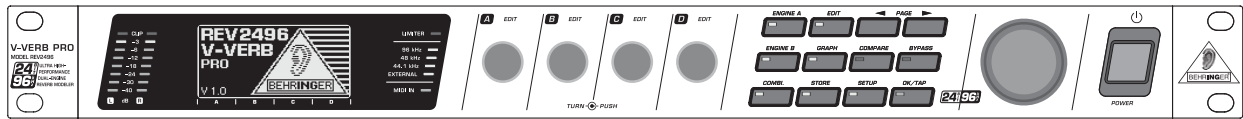

- ▲ Reference-class reverb modeling processor with high-quality 24-bit/96 kHz A/D and D/A converters
- ▲ Full 4-channel operation up to 96 kHz without any limitations, providing two separate effects processors in one unit
- ▲ 8 high-end reverb algorithms, modeled after world-class reverb processors
- ▲ Additional high-quality modulation effects from X-over Delay to Chorus/Flanger plus stereo Compressor
- ▲ Full-featured digital interface with AES/EBU In/Out, optical S/PDIF In/Out, Wordclock In and MIDI function for flexible use with digital equipment
- ▲ Ultra high-resolution SHARC® processor with 32-bit internal signal processing for ultimate sonic resolution
- ▲ 10 different routing types for flexible assignment of analog and digital connectors to both stereo engines
- ▲ Innovative user interface with soft push/turn encoders, big preset wheel, high-resolution graphic LCD display and additional TAP button for delay times
- ▲ Direct access to 4 effect parameters makes editing easy and comfortable
- ▲ Intuitive editing of up to 30 parameters using specially designed graphic mode
- ▲ Separate ROM and user preset banks with 400 presets total
- ▲ Balanced inputs and servo-balanced outputs with gold-plated XLR and ¼" TRS connectors
- ▲ Open architecture allows future software updates via MIDI
- ▲ Internal switch-mode power supply for maximum flexibility (100 - 240 V~), noise-free audio, superior transient response plus lowest possible power consumption for energy saving
- ▲ Ultra-rugged construction ensures long life, even under most demanding conditions
- ▲ Designed in Germany. Manufactured under ISO9000 certified management system

V-VERB PRO REV2496

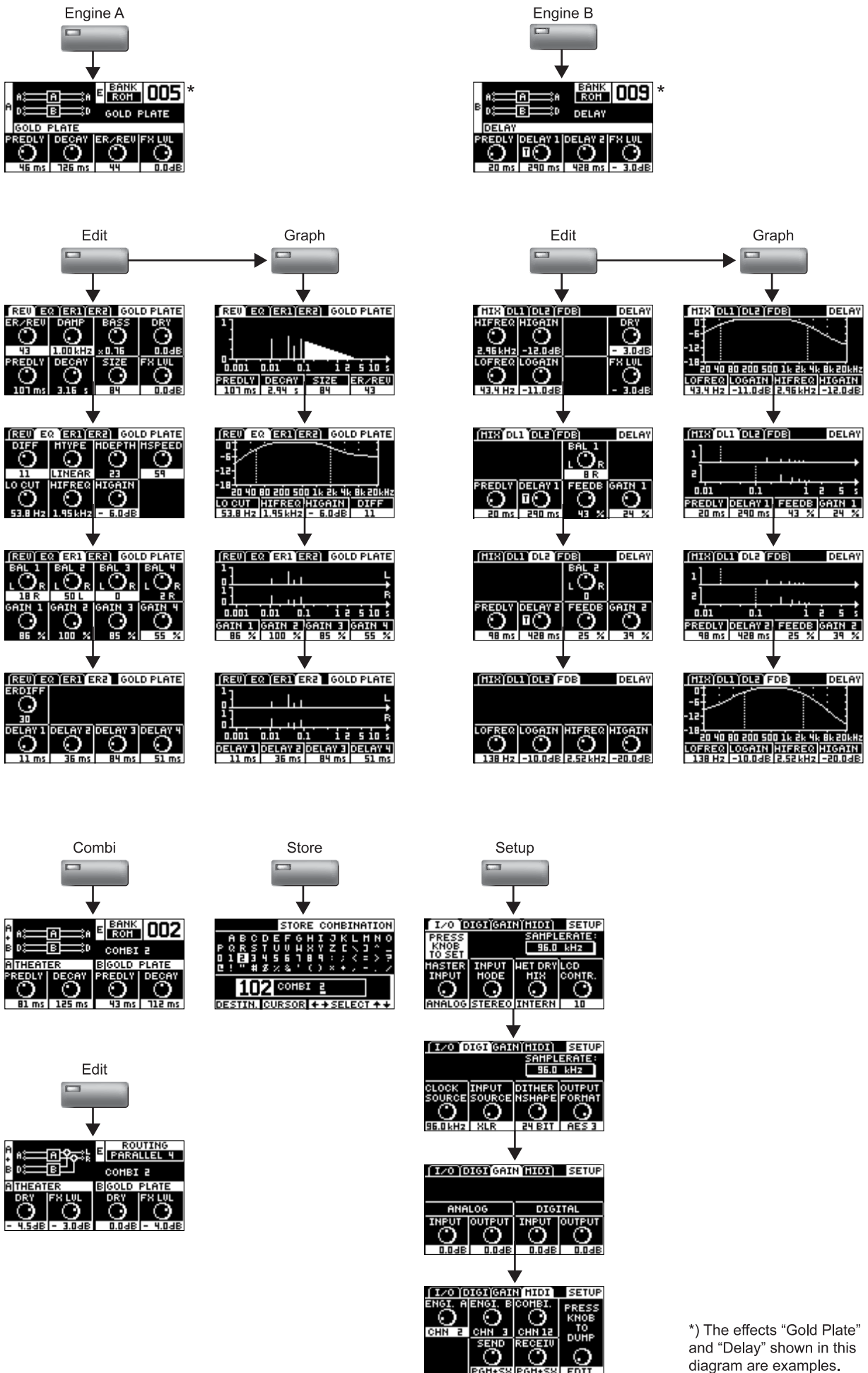

*) The effects "Gold Plate" and "Delay" shown in this diagram are examples.

FOREWORD



Dear Customer,
welcome to the team of V-VERB PRO users and thank you very much for expressing your confidence in us by purchasing the REV2496.

Writing this foreword for you gives me great pleasure, because it represents the culmination of many months of hard work delivered by our engineering team to achieve a very ambitious goal: to present a first-class reverb processor, whose outstanding audio quality makes it a welcome addition to

every studio. The task of designing our new V-VERB PRO REV2496 certainly meant a great deal of responsibility which we assumed by focusing on you, the discerning user and musician. Meeting your expectations also meant a lot of work and night shifts. But it was fun, too. Developing a product usually brings a lot of people together, and what a great feeling it is when all who participated in such a project can be proud of what they've achieved.

It is our philosophy to share our enjoyment with you, because you are the most important member of the BEHRINGER team. With your highly competent suggestions for new products you've made a significant contribution to shaping our company and making it successful. In return, we guarantee you uncompromising quality as well as excellent technical and audio properties at an extremely reasonable price. All of this will enable you to give free rein to your creativity without being hampered by budget constraints.

We are often asked how we manage to produce such high-quality devices at such unbelievably low prices. The answer is quite simple: it's you, our customers! Many satisfied customers mean large sales volumes enabling us to get better purchasing terms for components, etc. Isn't it only fair to pass this benefit on to you? Because we know that your success is our success too!

I would like to thank all of you who have made the V-VERB PRO possible. You have all made your own personal contributions, from the developers to the many other employees at this company, and to you, the BEHRINGER user.

My friends, it's been worth the effort!

Thank you very much,

Uli Behringer

TABLE OF CONTENTS

| | |
|--|-----------|
| 1. INTRODUCTION | 6 |
| 1.1 Before you get started | 6 |
| 1.1.1 Shipment | 6 |
| 1.1.2 Initial operation | 6 |
| 1.1.3 Warranty | 6 |
| 1.2 About this manual | 6 |
| 1.3 Digital reverberation—then and now | 7 |
| 1.4 Digital reverb modeling | 7 |
| 2. CONTROL ELEMENTS AND CONNECTIONS | 7 |
| 2.1 The front | 7 |
| 2.2 The rear | 8 |
| 3. OPERATION | 9 |
| 3.1 The effect presets | 9 |
| 3.2 Selecting presets | 9 |
| 3.3 Editing presets | 9 |
| 3.3.1 Simple editing | 10 |
| 3.3.2 Extensive editing in EDIT mode | 10 |
| 3.4 Editing combinations | 10 |
| 3.5 COMPARE function | 12 |
| 3.6 STORE—Storing programs | 12 |
| 3.7 Restoring factory presets | 12 |
| 3.8 SETUP menu | 12 |
| 3.8.1 I/O page | 12 |
| 3.8.2 DIGI page | 13 |
| 3.8.3 GAIN page | 13 |
| 3.8.4 MIDI page | 13 |
| 4. EFFECTS | 14 |
| 4.1 V-Verb | 14 |
| 4.2 Concert hall, cathedral, theater | 15 |
| 4.3 Gold Plate | 15 |
| 4.4 Ambience, gated reverb, reverse reverb | 16 |
| 4.5 Delay | 16 |
| 4.6 XOver Delay | 17 |
| 4.7 Chorus/Flanger | 17 |
| 4.8 Phaser | 18 |
| 4.9 Tremolo | 19 |
| 4.10 Compressor | 19 |
| 5. APPLICATIONS | 20 |
| 5.1 Using the V-VERB PRO in the aux bus | 20 |
| 5.2 Using the V-VERB PRO in the insert path | 21 |
| 5.3 The V-VERB PRO as a guitar effects processor | 21 |
| 5.4 The V-VERB PRO in digital environment | 22 |
| 5.5 The V-VERB PRO in 4-channel operation | 22 |
| 6. MIDI FUNCTIONS | 23 |
| 6.1 MIDI settings | 23 |
| 6.2 Program changes | 23 |
| 6.3 Controller commands | 23 |
| 6.4 Backing up data via MIDI | 24 |
| 7. INSTALLATION | 24 |
| 7.1 Installation in a rack | 24 |
| 7.2 Audio connections | 24 |
| 7.3 Digital inputs and outputs | 24 |
| 7.4 WORDCLOCK connection | 25 |
| 7.5 MIDI connections | 25 |
| 8. OPERATING SOFTWARE | 25 |
| 9. SPECIFICATIONS | 26 |
| 10. MIDI IMPLEMENTATION | 26 |
| 11. WARRANTY | 27 |

V-VERB PRO REV2496

1. INTRODUCTION

Thank you very much for expressing your confidence in BEHRINGER products by purchasing the V-VERB PRO, an extremely capable reference-class reverb modeling effects processor. The REV2496 was specially developed to produce first-class reverb effects with breathtakingly natural sound. We are particularly proud of the revolutionary REVERB MODELING that not only makes authentic replication of different spaces possible, it also let us recreate some of the most well-known high-end reverbs.

Thanks to its dual-engine architecture, the REV2496 can process two effects at one time at 96 kHz. In doing so, you can freely select both the effect type and signal routing.

In addition to eight first-class reverbs, there are also six additional effects, such as X-over delay, chorus/flanger and a stereo compressor.

Despite a plethora of adjustment possibilities of up to 30 parameters per effect algorithm, there is no need to delve deeply into its menu structure. Thanks to its innovative front panel, the REV2496 is easy and intuitive to use. Its four soft, infinitely variable controls with additional tap function, the high-resolution 128 x 64 LCD and the large rotary preset controls lend your creativity a helping hand.

The powerful SHARC® processor with internal 32-bit signal processing, coupled with the 24-bit/96 kHz AD/DA converters, assure that carefully programmed effects are calculated in high resolution and exit the REV2496 in the highest audio quality. Integration into your existing studio equipment is a breeze thanks to digital audio connections in the AES/EBU and S/PDIF formats. In addition, the Wordclock input and MIDI connections assure flexible connectivity options in all kinds of situations.

Thanks to its extensive MIDI implementation possibilities, the REV2496 can be used in practically all MIDI setups. Of course, controller and SysEx data from your REV2496 can be sent and stored if you use the MIDI interface. This way, by means of just one SysEx dump, various presets and settings can be stored on your sequencer or uploaded back to the REV2496.

Future-oriented BEHRINGER technology

To ensure the highest possible operational reliability, all our equipment is manufactured adhering to the highest quality standards in the industry. Furthermore, all our equipment is manufactured according to the ISO9000 certified management system.

Balanced inputs and outputs

The BEHRINGER REV2496 features balanced inputs and servo-balanced outputs. The servo function operates automatically and can detect when unbalanced connecting cables are connected. This prevents the occurrence of signal-level discrepancies between input and output signals.

 **This user's manual will help you familiarize yourself with the control elements, letting you learn all the functions. Please read the manual carefully and keep it for future reference.**

1.1 Before you get started

1.1.1 Shipment

The V-VERB PRO REV2496 was carefully packed at the factory and the packaging is designed to protect the unit from rough handling. Nevertheless, we recommend that you carefully examine the packaging and its contents for any signs of physical damage that may have occurred during transit.

 **If the unit is damaged, please do NOT return it to BEHRINGER, but notify your dealer and the shipping company immediately. Otherwise, claims for damage or replacement may not be granted.**

 **To assure optimal protection of your REV2496 during use or transport, we recommend using a case or a 19-inch rack.**

 **Always use the original packaging to avoid damage during storage or transport.**

 **Never let unsupervised children tamper with the equipment or its packaging.**

 **Please dispose of the packaging material in an environmentally friendly way.**

1.1.2 Initial operation

Be sure that there is enough space around the unit for cooling. To avoid overheating, do not place the REV2496 on top of power amps or near radiators, etc.

 **Blown fuses must be replaced by fuses of the same type and rating. Please refer to the "SPECIFICATIONS" for further details.**

The mains connection is made using the enclosed power cord and a standard IEC receptacle. It meets all international safety certification requirements.

 **Please make sure that all equipment is properly grounded at all times. For your own safety, never remove or disable the ground conductor of the unit or of the AC power cord.**

1.1.3 Warranty

Please take the time to fill out and return the warranty card within 14 days after the date of purchase to benefit from our extended warranty. The serial number is located on the top side of your REV2496. You can also register online at www.behringer.com.

1.2 About this manual

This manual has been designed so that you can get a clear overview of all control elements and at the same time find detailed information on how to use them. To let you quickly get an overview of different topics, we have grouped various control elements according to their function. If you need more information on specific topics, please visit our web site at www.behringer.com. For example, there you can find complete information about MIDI implementation.

1.3 Digital reverberation—then and now

Simulated reverberation has certainly come a long way over the past five decades. A necessity to be able to create a first-class reverb effect became apparent early on, particularly in recording studios. To get a step closer to this goal, all kinds of technological approaches were tried. In the '50s and '60s, the landscape of recording studios was dominated by special (physical) reverb chambers, reverb plates and classical spring reverbs. But the world of artificial reverberation could undergo a revolution only with the advent of digital technology. The possibility to influence the reverberation period and frequency response of an artificially created sound gave sound engineers the kind of freedom that people could previously only dream of. As the prices of digital reverbs gradually started to decline, such equipment was for the first time within the financial reach of a large cross-section of musicians (and not just big recording studios and broadcasters). Still, one cannot deny the existence of a substantial quality difference between professional equipment and the so-called "consumer" equipment. Even today, only a handful of reverb processors on the market can truly impress the most discerning listeners. It was often the case that the disadvantages of different units were not apparent until a direct comparison was performed.

1.4 Digital reverb modeling

The development of the V-VERB PRO started about six years ago. We started by developing many different algorithms, evaluating them in a multitude of listening tests. Early in this process, a large variety of building blocks for reverberation algorithms was created, letting us later use these building blocks to "model" realistic acoustic environments (i.e. to create them virtually). But that was not enough: simulations of well-known studio standards were now also possible. Even though many "vintage" digital reverbs are currently becoming popular again, professional studios nowadays mainly use two different kinds of reverberation:

1. Natural-sounding reverberation

Reverb classics that are used in the world's top studios belong to this family. Instead of modeling room impressions, special algorithms are created that simulate the sound of complete acoustic environments. The result are very smooth and warm reverb tails with deep room impressions, ideally suited for making music.

2. Reverbs that simulate realistic room impressions

A new family of reverb processors that have been programmed to replicate real acoustic spaces has established itself in recent times. Unlike with the classic reverb design philosophy, this family of reverbs approaches the task of acoustic space replication by dividing the dynamic behavior of impulses into two basic elements, namely into two different processor blocks:

1. An Early Reflections Generator creates the first component of the impulse response for a variety of acoustic spaces.
2. A second generator creates the late reverb tail and allows adjusting decay times in up to four different frequency bands.

We started the development of the V-VERB PRO with the intention at combining the best of these two worlds. In doing that, it was very important to us to implement both concepts for creating room impressions. What ended up being produced is our new reverb modeling technology that allows us to accurately recreate all types of reverberation. This process consists of both mainstream and new methods.

Regardless of which design philosophy you personally prefer, the V-VERB PRO gives you a choice: both warm, prominent reverb effects with a natural sound as well as realistic roominess, whose impact can be defined to the most minute detail.

From day one it was always our goal to program such reverb effects that would make everything else seem simply second-class. By implementing an extremely powerful signal processor operating internally at 88.2/96 kHz, we succeeded at noticeably improving the resolution and transparency. High processing power and an efficient processor operation allow for computing extremely complex room models. The floating point calculation, unique in this price segment, creates dynamics that guarantee low distortion and ultra-transparent fade-outs of late reverb phases. We are particularly proud that the V-VERB PRO is the first of its kind to succeed in creating and combining early and late reverberations in completely new and original ways. By utilizing innovative reverb modeling, we are now able to create such naturally-sounding room impressions that were previously possible only in physical, "real" spaces.

2. CONTROL ELEMENTS AND CONNECTIONS

In this chapter we will describe the different control elements of your V-VERB PRO. All controls and connections are described in detail, and you'll also get useful advice about how to use them.

2.1 The front

Controlling your REV2496 is menu-driven. This means that some control elements have different functions depending on the menu in which you are currently working. This reduces the number of keys and controls necessary to operate your REV2496, so the control panel is very clearly arranged. The large LCD always clearly indicates the current function assigned to a particular control element.

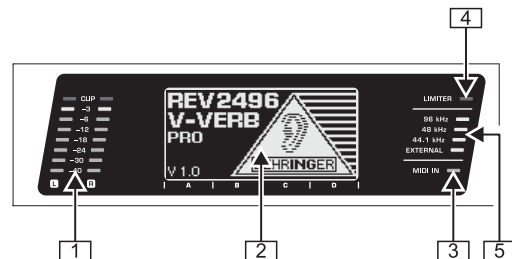

Fig. 2.1: Display section of the REV2496

- 1 The LED meter indicates the REV2496's input signal. The red CLIP LED illuminates as soon as the input signal level is too high, indicating the possibility of audible distortion.
- 2 The display shows all the menus necessary for controlling your REV2496. The function that is assigned to controls EDIT A - EDIT D (6) is indicated beneath the LCD and depends on the menu you are in.
- 3 The MIDI IN LED indicates that MIDI data is being received.
- 4 The red LIMITER LED lights up if one of the peak limiters in the output section is engaged.
- 5 These LEDs indicate the selected sampling frequency. It can be selected in the setup menu. The EXTERNAL LED lights up if the REV2496 is being externally synchronized. The external synchronization can be done either via the digital audio inputs or through the Wordclock input (23).

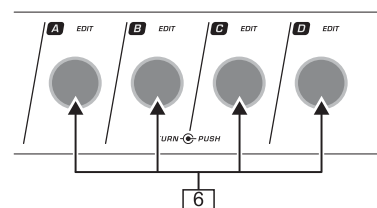

Fig. 2.2: EDIT controls A - D

V-VERB PRO REV2496

- 6 The four infinitely variable controls *EDIT A - EDIT D* are used for changing all parameter values. The assigned function and the current value are indicated on the LCD.

Additionally, these controls have a tap function, letting you alternate between two parameters in the edit menu or confirm your settings in the setup menu.

The infinitely variable controls EDIT A - D respond dynamically. This means that the rate at which parameters are changed depends on the speed with which you turn these controls. The faster you turn, the greater the parameter value change.

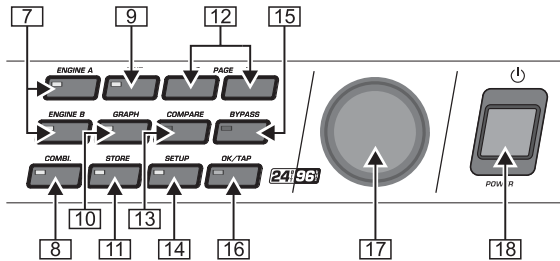

Fig. 2.3: Function keys and preset control

- 7 **ENGINE A** and **ENGINE B**. Use these keys to select the processors ("engines") you will work with. Each engine corresponds to one stereo effect. Since both of the engines can be directly dialed up, you can very quickly alternate between the effect from engine A and the effect from engine B. Pressing one of these two keys activates the recall level. There, you can change the values of the four most important effect parameters using the infinitely variable controls *EDIT A - D* without having to activate edit mode.
- 8 Use the **COMBI**. key to select a combination program. A combination program contains the values for both engines. If you press the **COMBI**. key, you activate the recall level of the combination program.
- 9 Press the **EDIT** key to go to the programming level. There, you can adjust all the parameters of an effect/effect combination.
- 10 Pressing the **GRAPH** key activates the **GRAPH** mode located within the **EDIT** level. The **GRAPH** mode lets you edit the effects with graphical visualization in the display. The parameters available here are the same as the parameters located in the **EDIT** level.
- 11 Use the **STORE** key to open the store menu. It lets you store presets, enter preset names and select storage locations.
- 12 Use **PAGE** ◀ / ▶ to scroll back and forth between individual pages (max. 4) within a menu.
- 13 The **COMPARE** key lets you compare the changes you just made in the previously selected preset. If you are in combination mode, pressing the **COMPARE** key will load the original combination preset with all of its settings. If **COMPARE** is active, the compare key LED lights up, and no value changes can be made. To go back to edit mode and store your changes, press the **COMPARE** key again.
- 14 Pressing the **SETUP** key gets you into the **SETUP** menu, where you have access to all global settings of your REV2496, e.g. input and output signal level, MIDI settings and so on. This way, you can adjust your REV2496 to the requirements of your particular application. More information about the extensive **SETUP** function can be found in chapter 3.8.
- 15 The **BYPASS** key has two functions, depending on the setting of the **WET DRY MIX** parameter on the **I/O** page of the setup menu:

If the parameter is turned to **INTERN**, pressing **BYPASS** bypasses the effects processors, letting you hear the "dry" signal.

If the parameter is turned to **EXTERN**, pressing the **BYPASS** key mutes the entire audio signal.

- 16 The **OK/TAP** key has two functions:

OK: After selecting a preset, press the **OK** key to load the new preset. (Each selection made using the preset wheel must be confirmed by pressing **OK**.) Additionally, **OK** is also used to confirm overwriting presets.

TAP lets you intuitively enter time values for delay and LFO speed parameters: tap the **TAP** key several times to the beat of the current song, and the effect adjusts automatically to the song's beat. The value is averaged out using the last four taps. The parameter values that can be adjusted using the **TAP** key are indicated with a letter "T" next to the respective parameter control on the display.

- 17 Use the **PRESET** infinitely variable rotary control to select a stored program.

- 18 Use the **POWER** switch to power up the REV2496. This switch should be set to "Off" before you connect the unit to the mains.

Attention: Using the POWER switch to power down your REV2496 does not completely disconnect it from the mains. If you don't plan on using your REV2496 for a prolonged period of time, please disconnect the cable from the mains.

2.2 The rear

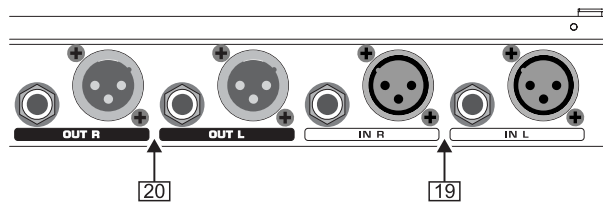

Fig. 2.4: Analog inputs and outputs

- 19 These are the analog **INPUTS** that are balanced 1/4" TRS and XLR connectors. Please make sure that the input signal is correctly adjusted. Signal levels that are too high (this could overdrive the converters of your V-VERB PRO) must always be avoided. Digital distortion is particularly unpleasant because it doesn't occur gradually; on the contrary, it occurs suddenly. When necessary, lower the signal level at your mixing console as well.

- 20 Both **OUTPUTS** of your REV2496 are also balanced 1/4" TRS and XLR connectors.

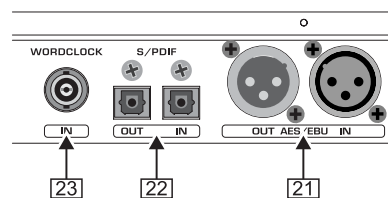

Fig. 2.5: Digital audio connections

- 21 The REV2496 features a digital **AES/EBU** interface with a XLR connector. Use it to feed in or export data in both **AES/EBU** and **S/PDIF** formats.

- 22 Audio data can also be fed in or exported at the digital optical interface. The format (**AES/EBU** or **S/PDIF**) can be selected in **SETUP**.

👉 You can use both digital and analog audio connections at the same time to supply both engines with different signals. Therefore, a fully equipped 4-channel reverb processor stands at your disposal. Even when running the REV2496 at 96 kHz, there are absolutely no performance limitations!

The master input is selected in the setup menu. You can change the input and output configuration in the COMBI. edit mode.

[23] At the **WORDCLOCK** input, you can connect an external wordclock signal for synchronizing your REV2496 through other equipment. This connector is provided as a high-impedance BNC coaxial connector and has no internal terminating resistor. Please follow the instructions given in chapter 7.4.

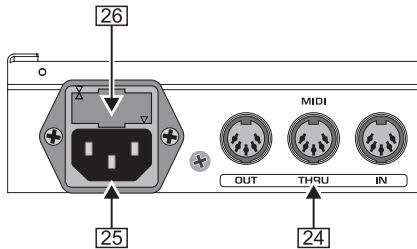

Fig. 2.6: MIDI connections and mains connector

[24] The MIDI connections allow communication between the REV2496 and other MIDI-enabled equipment. MIDI data is received via the **MIDI IN** connector, and MIDI commands are sent out via the **MIDI OUT** connector. Incoming MIDI commands are passed unprocessed to the **MIDI THRU** connector.

[25] The mains connection is established using a cable with an IEC mains connector. An appropriate mains cable is included.

[26] You can replace fuses at the **FUSE SWITCH** of the REV2496. Always replace fuses with the same type. Please follow the instructions given in chapter 9“SPECIFICATIONS.”

3. OPERATION

3.1 The effect presets

The first time that you use the REV2496, we suggest first working with effect presets before you start programming your own effects. The REV2496 features two independent processors (so-called engines) that can be used individually or at the same time. Each engine can process a different effect.

👉 Please keep in mind that engines always run in pairs and are wired according to the selected routing (see fig. 3.6). The routing is assigned and stored in the COMBI. edit mode.

The REV2496 features 400 memory locations that are subdivided as follows: 200 slots reserved for the engines A and B as well as additional 200 locations for the combination effects.

Both subdivisions of 200 storage slots are further divided up into two banks with 100 slots each. The first 100 slots (001 - 100) are factory presets that cannot be overwritten, and are labeled in the display on the recall page under **BANK** as **ROM** (Read Only Memory). The remaining 100 slots can be overwritten and are labeled “**USER**”. Both banks are located back-to-back, whereby the **ROM** presets (001 - 100) are shown first (by using the **PRESET** wheel), followed by the **USER** presets (101 - 200).

| | ROM | USER |
|--------------|---------|---------|
| Engines A+B | 001-100 | 101-200 |
| Combinations | 001-100 | 101-200 |

Tab. 3.1: Storage slots of the REV2496

The REV2496 features 14 effect algorithms. An algorithm is basically a mathematical formula that calculates a particular effect type (e.g. reverb or delay). You could also compare the REV2496 to a computer whose processor capacity can be used for a multitude of programs with different purposes. An algorithm would in this case correspond to a computer program. All algorithms are described in detail in chapter 4. Each of the first 14 storage slots (001 to 014) contains one of the algorithms. Therefore, if you are looking for a particular effect type, you should load up one of these presets.

3.2 Selecting presets

When you power up your REV2496, the preset you used last is automatically loaded. To dial up another preset, press **ENGINE A**, **ENGINE B** or **COMBI.** key, depending on whether you wish to load a preset into the engine A, engine B or if you are loading a combination preset. Then, select the desired preset number using the **PRESET** wheel. Press **OK/TAP** to confirm your selection. The preset is now loaded. If you don't want to load up a new program, or if you accidentally selected one, press **ENGINE A**, **ENGINE B** or **COMBI.** to go back to the current preset.

👉 The new preset is only loaded after you confirm your choice by pressing the OK/TAP key.

👉 When changing presets, please keep in mind that different effect algorithms may have different volume levels. Therefore, when selecting a new preset, first reduce its volume. Volume differences can be equalized with the storable Parameter FX Level (see chapter 3.8.3).

3.3 Editing presets

You can change any preset to adjust it to your own preferences or to the requirements of a particular instrument or musical piece. The REV2496 features a plethora of parameters (with V-Verb, up to 30) that let you modify every detail of an effect. To help you keep track of these adjustment options, there are several ways of editing effects available to you:

- ▲ simple editing of the four most important parameters directly after loading a preset
- ▲ editing of all parameters in the **EDIT** menu
- ▲ editing with graphical visualization (**GRAPH** menu)

These different operating modes are explained in detail in the following chapters:

V-VERB PRO REV2496

3.3.1 Simple editing

Immediately after loading a preset, you will be in the recall level. Here, you have access to four parameters for an effect (see table 3.1). The selection of these four parameters was made to let you quickly and simply modify the most important effect parameters.

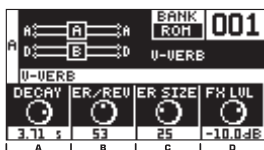

Fig. 3.1: Engine A (recall page)

With controls EDIT A, B, C and D you can adjust the values of these four parameters. The parameters and the current values are shown in the bottom portion of the display. EDIT D is in this case always assigned to the effect volume (FX Level), to the mix (with modulation effects) or to the gain (compressor).

| Effect | EDIT A | EDIT B | EDIT C | EDIT D |
|----------------|----------|---------|---------|----------|
| V-Verb | Decay | ER/Rev | ER Size | FX Level |
| Concert | Predelay | Decay | ER/Rev | FX Level |
| Cathedral | Predelay | Decay | ER/Rev | FX Level |
| Theater | Predelay | Decay | ER/Rev | FX Level |
| Gold Plate | Predelay | Decay | ER/Rev | FX Level |
| Ambience | Predelay | Decay | Size | FX Level |
| Gated | Predelay | Density | Decay | FX Level |
| Reverse | Predelay | Rise | Decay | FX Level |
| Delay | Predelay | Delay 1 | Delay 2 | FX Level |
| X-over Delay | Delay 1 | Delay 2 | Delay 3 | FX Level |
| Chorus/Flanger | Speed | Mod Dly | Feedb | Mix |
| Phaser | Speed | Depth | Reson | Mix |
| Tremolo | Speed | Phase | LFO Mod | Mix |
| Compressor | Thresh | Ratio | Attack | M-Gain |

Tab. 3.2: Parameters with direct access (recall level)

3.3.2 Extensive editing in EDIT mode

Press the EDIT key to get to the EDIT mode. The display now shows the first of the four EDIT pages. You can scroll back and forth through individual pages using PAGE ◀ / ▶. There is a maximum of eight parameters per page. If two parameter controls are shown in the display above one another, press EDIT to alternate between the top and the bottom parameter.

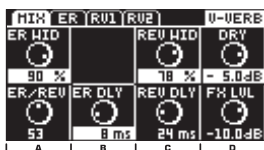

Fig. 3.2: EDIT page 1

👉 The effect algorithm for a preset can not be selected. If you wish to edit a preset, first load a program based on the preset. The ROM presets 001 to 014 contain the algorithms 1 to 14.

👉 A more detailed description of individual parameters can be found in chapter 4 "EFFECTS."

3.3.3 Editing engines in GRAPH mode

Within the EDIT operating mode, the GRAPH mode lets you edit parameters with graphic visualization. Almost every EDIT page has its own GRAPH page. By pressing the GRAPH key, you can switch between the EDIT menu and the GRAPH menu at any time.

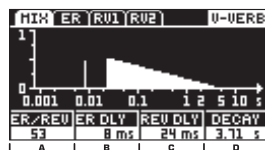

Fig. 3.3: GRAPH mode

When you are on the GRAPH pages, you have direct access to a maximum of four parameters that can be modified with EDIT A - D. With some effects, you can press the EDIT control to alternate between two parameters. This way, you have access to the four most important parameters for an effect.

3.4 Editing combinations

Press the COMBI. key to get to the combinations level. The vertical bar on the left in the display shows "A + B."

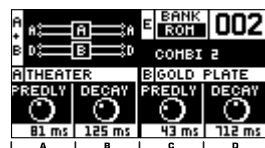

Fig. 3.4: Combination recall page

When in recall mode, you can use the controls EDIT A and EDIT B to adjust the two most important engine A parameters; or you can use EDIT C and EDIT D to adjust the two most important engine B parameters.

When in the EDIT mode (EDIT key pressed), you can modify two level parameters for each engine. These two parameters (with the exception of the compressor effect) can be muted by pressing the EDIT infinitely variable rotary control. When you leave the EDIT mode, the mute function is automatically cancelled.

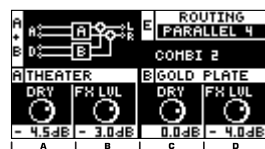

Fig. 3.5: EDIT page of a combination effect

Effects and the editable parameters are shown below:

| COMBI | Recall | | Edit | |
|----------------|-----------|---------|--------|----------|
| | Par. 1 | Par. 2 | Par. 1 | Par. 2 |
| V-Verb | Decay | ER/Rev | Dry | FX Level |
| Concert | Predelay | Decay | Dry | FX Level |
| Cathedral | Predelay | Decay | Dry | FX Level |
| Theater | Predelay | Decay | Dry | FX Level |
| Gold Plate | Predelay | Decay | Dry | FX Level |
| Ambience | Predelay | Decay | Dry | FX Level |
| Gated | Predelay | Density | Dry | FX Level |
| Reverse | Predelay | Rise | Dry | FX Level |
| Delay | Predelay | Delay 1 | Dry | FX Level |
| X-over Delay | Delay 1 | Delay 2 | Dry | FX Level |
| Chorus/Flanger | Speed | Moddly | Mix* | Gain* |
| Phaser | Speed | Depth | Mix* | Gain* |
| Tremolo | Speed | Phase | Mix* | Gain* |
| Compressor | Threshold | Ratio | Attack | M-Gain |

*) The push function of the mic control mutes the "Dry" signal, the push function of the gain control mutes the effect signal (FX LVL)

Tab. 3.3: Effect parameters in COMBI. mode

If you wish to adjust the effect selection of the combinations, press ENGINE A and load the desired preset into this engine. Then, press ENGINE B and select the desired preset for engine B (in both cases, confirm your selection by pressing OK/TAP).

To adjust the routing of a combination, first press the EDIT key and select a routing using the PRESET wheel (Parallel 1 - 6, Serial 1 - 4). Confirm by pressing OK/TAP. Ten routing configurations are at your disposal:

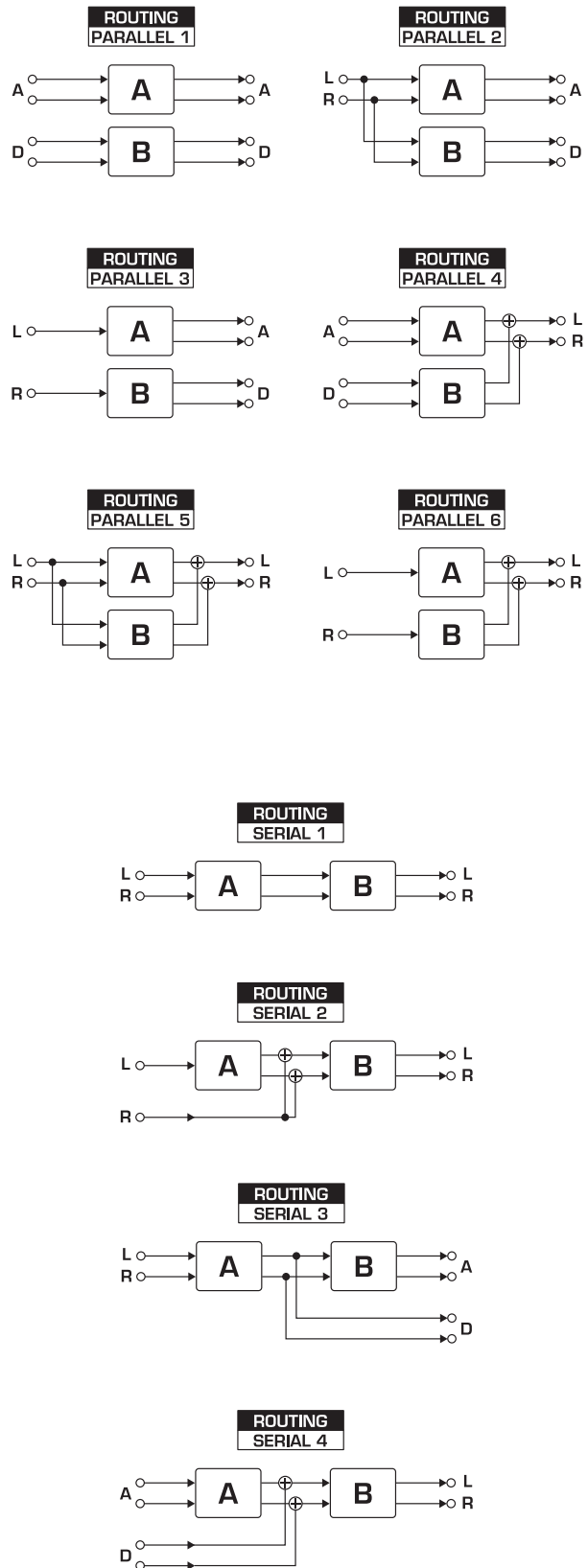

A = Analog inputs/outputs; D = Digital inputs/outputs

Fig. 3.6: Routing options for various combinations

The routing, the selected preset numbers as well as the four most important parameters (see table 3.2) of each of the two engines can be stored in any combination. The settings of these four parameter values are not overwritten in the engine presets. As usual, you can implement more complex edits of individual effects in the EDIT level of the engines.

V-VERB PRO REV2496

3.5 COMPARE function

After making adjustments to a preset, the COMPARE function lets you compare the changes you just made with a previous preset **before you store the changes**. To do this, press the COMPARE key. As long as this key's LED is illuminated, additional edits are temporarily not possible. If you press COMPARE again, you go back to your personal edit. Now you can either store your changes (see the next chapter) or continue editing.

3.6 STORE—Storing programs

As soon as you make an adjustment to a preset, "E" (short for "Edited") is shown on the LCD. If you wish to keep your changes, you can store them in one of the USER storage spaces as a preset. Pressing the STORE key opens the STORE menu.



Fig. 3.7: STORE page

Using EDIT A or the PRESET wheel, you can now select the storage location where you wish to store the modified program. Please keep in mind that storage slots 001 - 100 are write-protected and can therefore not be overwritten. If you press the EDIT A control, the name of the edited preset is shown.

Use the controls EDIT B, C and D to name the preset (maximum 12 characters long):

By turning the EDIT C and D controls, you can select different characters horizontally and vertically. Press these controls to confirm your character selection, after which the cursor in the name field moves to the next position. By turning the EDIT B control, you can directly dial the individual name positions. By pressing the EDIT B control, the character in the current position is erased, and the characters behind it move forward one position.

If you dialed a storage slot and named a preset, please press OK or STORE to store your changes. The following prompt is then shown on the display:



Fig. 3.8: Confirmation request before storing a preset

Confirm by pressing OK/TAP. Your REV2496 goes back to the Recall/Preset mode.

You can exit the STORE menu at any time without storing your preset by pressing ENGINE A, ENGINE B or COMBI.

After storing a preset, all previous settings in this preset location are overwritten and the new parameters are stored. If you change your mind and decide to keep the old preset (without losing the newly made changes), before pressing the STORE key for the second time, use EDIT A to select another storage location for your new preset.

3.7 Restoring factory presets

While powering up your REV2496, keep the STORE key pressed to restore factory presets. A confirmation request is shown in the display. Confirm by pressing OK/TAP.

Restoring factory presets overwrites all presets you have made!

3.8 SETUP menu

While in the SETUP menu, you can make adjustments to your V-VERB PRO that will have an effect on all presets. These include the input and output configuration as well as level and MIDI settings. Individual functions are described in subsequent sub chapters (3.8.1 - 3.8.4).

Press the SETUP key to go to the SETUP menu. You can scroll through the sub menus using the PAGE ◀ / ▶ keys. The four infinitely variable rotary controls are now used for adjusting the SETUP parameters. With some parameters, you will have to press the corresponding EDIT control to confirm your selection. To exit the SETUP menu, simply select another menu (ENGINE A, ENGINE B or COMBI.).

3.8.1 I/O page



Fig. 3.9: SETUP page 1

Master Input: Use EDIT A to select the master input (ANALOG or DIGIT.). This selection only has an effect on those routings that only use one stereo input (parallel 2,3,5,6, serial 1-3). You can identify these routings because they are labeled with "L" and "R" (instead of "A" and "D") in the routing graphic on the display on the COMBI. or edit page (also see table 3.3). The LED level indicator always shows the master input signal.

Input Mode: Use EDIT B to select if the input signal should be in mono or in stereo. If you only use the left input, please select mono operation.

Wet/Dry Mix: Use the EDIT C control to alternate the mix mode between internal and external. The selection of the settings depends on the REV2496's application. If you for example wish to operate your V-VERB PRO via the aux paths of a mixing console, you should activate **EXTERNAL**. The effect ratio on the output of the REV2496 is then always 100%, and the mix ratio between the dry and the effect signal is made in the mixing console. This way, the parameters "Dry" or "Mix" are omitted.

Depending on the selected routing, this parameter has the following impact:

Parallel 1 - 6: The dry parameter of both engines is not adjustable.

Serial 1 - 4: The control of the "Dry" and "Mix" parameters in Engine A is still active, and Engine B is not adjustable.

If you wish to use your REV2496 together with a guitar amp that features a serial effects loop, or if you wish to use it as an insert effect, select **INTERNAL**. Additional information about this application can be found in chapters 5.3 and 5.4.

LCD Contrast: Use EDIT D to adjust LCD contrast.

3.8.2 DIGI page

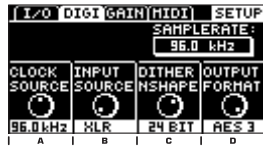

Fig. 3.10: SETUP page 2

Clock Source: Here you can select the clock speed of the REV2496. You can select between the following internal clock speeds: 44.1, 48 or 96 kHz. If you wish to externally synchronize your REV2496 (slave operation), you can select if the clock speed will be via the external BNC wordclock input (WDCLK) or via the digital input (DIG. IN). If you wish to use your REV2496 as a slave and at the same time wish to use the analog inputs, a synchronization via the wordclock input or via one of the two digital inputs is necessary.

Input Source: With the EDIT B control, you can decide which of the two digital inputs will be used: the optical input (OPT.) or the XLR input (XLR).

Dither and Noise Shaper: The EDIT C control has a dual function. Here, you can select if you want to accomplish dithering for the digital output signals, or if you also want to use additional noise-shaping. The following settings can be made:

| Display | Function |
|------------------|---|
| OFF | Dithering and Noise Shaper deactivated |
| 24 BIT | Only dithering at 24 bit |
| 20 BIT | Only dithering at 20 bit |
| 16 BIT | Only dithering at 16 bit |
| 24 BIT (+NSHAPE) | Dithering with activated Noise Shaper at 24 bit |
| 20 BIT (+NSHAPE) | Dithering with activated Noise Shaper at 20 bit |
| 16 BIT (+NSHAPE) | Dithering with activated Noise Shaper at 16 bit |

Tab. 3.4: Setting possibilities for dithering and noise shaping

☞ **“Dithering”** refers to a low-level signal that is added to the audio signal in order to reduce the so-called quantization. It should be adjusted to the word rate (bit rate) that the associated equipment can support. The **“Noise-Shaping”** function displaces the noises created through dithering into a less perceptible frequency range.

Output Format: The EDIT D control adjusts the format of the digital data flow at the output. The professional AES/EBU (AES3) format and the consumer S/PDIF format are available. The selected format applies to both digital outputs, i.e. if you use an appropriate cable, you can forward a signal from the XLR output in the S/PDIF format to another piece of equipment with a S/PDIF connection.

3.8.3 GAIN page



Fig. 3.11: SETUP page 3

Here, you can adjust the signal level of analog and digital inputs and outputs. A signal level adjustment of +/- 6 dB is possible.

The REV2496 features two automatic, non-disengageable **Peak Limiters** in the output section of both engines. If signal peaks occur, these peak limiters effectively eliminate them. If the peak limiters engage, the corresponding LIMITER LED illuminates. In this case, please reduce the input/output level until the LED is no longer illuminated or only lights up occasionally.

The level indicator of your REV2496 indicates the input that was selected as master input on the I/O page of the setup menu. During level setting of the digital input, if you want to see a signal on the LED ring, you have to select this input as master input.

3.8.4 MIDI page



Fig. 3.12: SETUP page 4

On this page, you can perform MIDI adjustments. For ENGINE A, B and for COMBI., different MIDI channels can be selected. This way, you can separately switch presets for both processors and assign different MIDI controllers.

The parameters SEND and RECEIVE let you activate individual MIDI functions on both the send and the receive ends. These are: Program Change, Controller and SysEx (system-exclusive data).

If you wish to carry out a MIDI dump, use EDIT D to determine beforehand if all user presets (ALL) or only the current setting of the selected combination and the settings of both engines (EDIT) are transmitted as SysEx data.

All MIDI functions are explained in detail in chapter 6.

4. EFFECTS

All effect algorithms and their parameters are described in this chapter. Depending on the effect, up to 30 parameters that affect the sound in different ways can be adjusted.

The actual signal flow of all effect algorithms is in stereo. However, for clarity's sake, all illustrations of the routing diagrams are drawn in mono. The only exception is the Tremolo effect, whose signal flow is depicted in stereo.

 **DRY** (the signal level of the “dry” signal) can only be adjusted if the mix mode in the setup menu is set to **INTERNAL** (compare ch. 3.8.1). If the mix mode is set to **EXTERNAL**, the **DRY** control in the display is not visible.

4.1 V-Verb

BANK
ROM 001
V-VERB

V-Verb is the most complex space-simulation algorithm in your V-VERB PRO. The generator for the early reflections (ER) is particularly elaborate, and can model a large number of primary reflections of various types of spaces. The reverb generator (REV) lets you adjust the reverberation period in four separate frequency ranges.

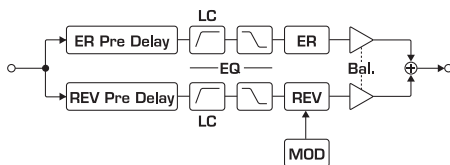

Fig. 4.1: V-Verb effect configuration

MIX ER RV1 RV2

With **ER WID** (Early Reflections Stereo Width), you can adjust the stereo width of early reflections. A value of 0% results in a mono signal. A value of 100% results in a maximal stereo effect. With **ER DLY** (Early Reflections Predelay), you can *additionally* delay early reflections. We say additionally because this value is already automatically calculated depending on the parameters such as room type, size and microphone distance (see below). Using **ER DLY**, this delay time can be increased, creating the impression of a larger room.

The parameters **REV WID** (Reverb Stereo Width) and **REV DLY** (Reverb Predelay) have the same function as **ER WID** and **ER DLY**, but refer to the reverb generator. Depending on the selected room size (**SIZE**), a delay time for the reverb tail is automatically enacted here as well. Use **REV DLY** to adjust this delay time if you want to boost the room impression.

Using **ER/REV** (Early Reflections/Reverb Mix), you can adjust the mix ratio between early reflections and late decay. A value of 0% results only in early reflections. A value of 100% results only in late decay.

The parameters **DRY** and **FX LVL** (effect level) control the effect mix ratio. **DRY** determines the signal level of the direct signal, while **FX LVL** controls the effect volume. The **DRY** parameter is only adjustable when the mix is set to **INTERNAL** in the setup. This control is therefore not shown in **EXTERNAL** mode.

MIX ER RV1 RV2

Two filters are located ahead of the ER generator. **LO CUT** (low cut filter) determines the frequency of a high pass filter, while **HI FREQ/HI GAIN** (high frequency/high gain) adjust the frequency and the level of a shelving filter, used for lowering the highs.

With **ER TYPE** (early reflections type), you can decide what type of space should be simulated. You can select between **AUDITO** (auditorium), **CATHED** (cathedral), **CONCER** (concert hall), **HALLWY**, **HANGAR**, **CHAMBE** (chamber), **STADIU** (stadium) and **STAGE**.

ER SIZE (early reflections size) determines the space size, while **MIC DIS** (microphone distance) determines the distance between the recording microphone and signal source. Value 1 means minimum distance, while value 5 means maximum distance.

The material of the wall surface can be selected using the **MATERI** (wall material) parameter. You can select between **TOTAL** (full reflexion), **GLASS**, **FIBER** (fiber glass), **MARBLE**, **CONCRE** (concrete), **GYP SUM**, **WOODEN** (hardwood floor), **PLY WOO**, **COTTON**, **CARPET**, **VELOUR** and **ACOUST** (acoustic).

With **ER DIFF** (early reflections diffusion), you can influence the degree of diffusion of the early reflections. Value 1 makes individual reflections clearly audible, and a value of 30 creates the greatest density possible.

MIX ER RV1 RV2

Two filters are located ahead of the reverb generator as well. **LO CUT** (low cut filter) determines the frequency of a high pass filter, and **HI FREQ / HI GAIN** (high frequency / high gain) adjust the frequency and the lowering of a shelving filter that processes the highs.

The parameter **SIZE** defines the size of the simulated space. It also influences the maximum reverberation time that is adjustable with **DECAY**.

The reverb generator's reverb tail can be modulated in two different ways using **MTYPE** (Modulation Type). **LINEAR** produces a chorus-like modulation; **RAND(OM)** produces a natural-sounding, less pronounced modulation. **MDEPTH** (modulation depth) and **MSPEED** (modulation speed) are used to adjust modulation depth and speed.

MIX ER RV1 RV2

The decay time can be separately adjusted for four different frequency ranges. The parameters **LO X-O** (low Xover frequency), **MID X-O** (mid Xover frequency) and **HI X-O** (high Xover frequency) determine the cut-off frequencies for individual frequency ranges.

With **LO DCY** (low band decay), the decay time for the lowest frequency range can be adjusted. The parameter value describes a factor that refers to the global decay time adjusted using **DECAY**. Similarly, both **MID DCY** (mid band decay) and **HI DCY** (high band decay) parameters control the decay time for both of the upper frequency ranges. This way, a frequency-dependent decay time whose sound character remains intact, even when decay times are changed, can be selected. Insider hint: editing the parameters on this menu page is much more intuitive and comfortable if you use the graphic editing mode.

The parameter **DIFF** (diffusion) determines the reflection density of the reverb tail. Low values give you more transparency, and higher values create a softer, more dense reverb tail.

4.2 Concert hall, cathedral, theater

These three effect algorithms are designed exactly the same, and differ only in the early reflexion pattern of the ER generator.

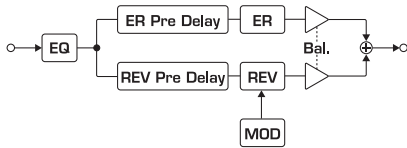

Fig. 4.2: Effect design for concert hall, cathedral and theater

BANK
ROM 002
CONCERT HALL

This algorithm features a very natural, soft reverb tail like you would hear in large concert hall. The early reflection echograms are derived from an acoustically superior concert hall that has been used for many high-quality recordings.

MIX ER REV MOD

A sound controller is located ahead of this effect. **LO CUT** (low cut filter) determines the frequency of the high pass filter, and **HI FREQ** (high frequency)/**HI GAIN** (high gain) adjust the frequency and the lowering of the shelving filter, used for adjusting high frequencies.

Using **ER/REV** (early reflections/reverb mix), you can adjust the mix ratio between early reflections and late reverb tail. A value of 0% creates only early reflections, while the value 100% creates only the reverb tail.

The parameter **DRY** determines the signal level of the direct signal, provided that you have activated the **INTERNAL** mode. **FX LVL** (effect level) controls the volume of the effect signal. Together, **DRY** and **FX LVL** control the effect mix ratio.

MIX ER REV MOD

Using **ER TYPE** (early reflexions type), you can determine the physical location of a recording microphone that is being used in a room. Available are **BACK**, **MIDDLE**, **FRONT** (near the sound source) and **BALCON** (elevated position). Using **ER SIZE** (early reflexions size), you can increase or decrease the size of the simulated space.

Using **ER DIFF** (early reflexions diffusion), you can adjust the diffusion degree for early reflexions. Value 1 makes individual reflexions clearly audible, while value 30 produces the highest density. With **ER DLY** (early reflexions pre-delay), you can further delay early reflexions (depending on room type, size and microphone distance).

MIX ER REV MOD

The **SIZE** (room size) parameter determines the size of the simulated space for the reverb generator. This parameter also influences the maximum decay time (RT60) that is adjustable using the **DECAY** (decay time) parameter. Using the **PREDLY** (reverb pre-delay) parameter, you can delay the trigger point for reverb tail.

The **DIFF** (diffusion) parameter determines the reflection density for reverb tail. Low values increase the transparency, while high values produce a softer, more dense reverb tail. The **SPREAD** parameter strengthens the room impression.

Just like with decay in real rooms, reverb tail dampens higher frequencies. The **DAMP** (dampening frequency) parameter determines the frequency above which dampening kicks in. Decay time for lower frequencies can also be separately adjusted. This is done using **BASS** (bass multiply). The **BASS** value describes a factor that refers to the decay time determined using **DECAY** (decay time). The **BASS F** (bass frequency) parameter determines the frequency above which **BASS** no longer engages.

MIX ER REV MOD

Reverb tail can be modulated on this page in two different ways, selectable with **MTYPE** (modulation type). **LINEAR** creates chorus-like modulation, while **RAND** produces random modulation. **MDEPTH** controls modulation depth, and **MSPEED** controls modulation speed.

BANK
ROM 003
CATHEDRAL

CATHEDRAL was optimized for very long decay times. Early reflections cover many big spaces with different structural shapes. The design of this effect is identical to **CONCERT HALL** and differs from it only in the **ER TYPE** parameter on the second **EDIT** page. The following types of spaces are available: **CHURCH**, **CHAPEL**, **CATHDR** (Cathedral) and **CASTLE**. The **SPREAD** parameter is not available.

BANK
ROM 004
THEATER

The **THEATER** algorithm is also based on the **CONCERT HALL** effect and contributes a surprising degree of liveliness.

Unlike with the **CONCERT HALL** effect, the following room types are available for early reflexions (**ER TYPE**, second **EDIT** page): **THEAT**. (Theater), **ARENA**, **CLUB**, **STADI**. (Stadium), **STAGE**, **STUDIO**, **OPERA** and **AMPHI** (Amphitheater).

A special feature of this effect is the **ATTACK** parameter that lets you determine how quickly the reflections in the reverb tail fade out. Low values produce a sudden fadeout, while high values result in a gradual fadeout with the highest density.

SPREAD influences the progression of the reverb tail. Low values describe a relatively linear curve, while high values create a less linear curve progression. This lets you create very interesting decay characteristics.

4.3 Gold Plate

BANK
ROM 005
GOLD PLATE

This algorithm is particularly well suited for drums and percussion. However, singing parts also benefit from the particularly dense reverb tail. The additional four-fold delay lets you create your own early reflexion patterns.

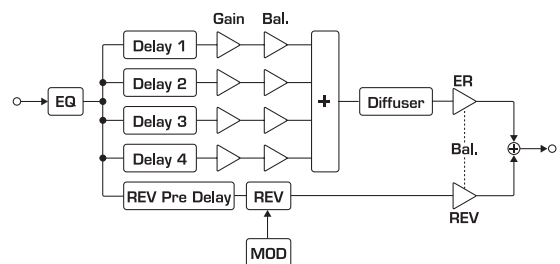

Fig. 4.3: Effect design for Gold Plate

REV EQ ER1 ER2

With **ER/REV** (early reflexions/reverb mix), you can adjust the mix ratio between early reflexions and late decay. The **DRY** and **FX LVL** (effect level) parameters control the mix ratio between the dry signal and effects signal. **DRY** determines the level of the direct signal (if mix is set to **INTERNAL**), while **FX LVL** controls the effect volume.

Using **DECAY**, you determine the decay time, whose maximum value depends on the reverb room size selected using **SIZE**. With the **PREDLY** (reverb pre-delay) parameter, you can delay the point at which the reverb tail is delayed.

V-VERB PRO REV2496

Just like in real physical spaces, the upper frequency range is dampened during decay. The **DAMP** (dampening frequency) determines the frequency at which dampening begins. The decay time for lower frequencies is adjusted using **BASS** (bass multiply), which is a factor that refers to the decay time adjusted using **DECAY**.

REV EQ ER1 ER2

LO CUT (low cut filter) determines the frequency of the high pass filter located ahead of the low cut filter. **HI FREQ** (high frequency) and **HI GAIN** (high gain) adjust the frequency and the lowering of the shelving filter for the high frequencies (treble).

DIFF (diffusion) determines the reflection density for the reverb tail. A low value provides higher transparency, and higher values create a softer, more dense reverb tail.

The modulation of the reverb tail can be adjusted using **MTYPE** (modulation type), **MDEPTH** (modulation depth) and **MSPEED** (modulation speed): **LINEAR** creates static modulation, while **RAND** produces random modulation. **MDEPTH** controls modulation depth, and **MSPEED** controls modulation velocity.

REV EQ ER1 ER2

The **BAL 1-4** (stereo balance 1-4) parameters control the stereo balance of the four delays, and the **GAIN 1-4** parameters control their volume.

REV EQ ER1 ER2

With **DELAY 1-4**, you can adjust the delay time of the four delays. With **ER DIFF** (early reflections diffusion), you can adjust the diffusion degree for the delays. Value 1 lets individual delays be clearly audible, while value 30 produces the greatest density.

4.4 Ambience, gated reverb, reverse reverb

Even though these three effect types are based on the same algorithm, their sound characteristics could not be more different.



Fig. 4.4: Effect design for ambience, gated reverb and reverse reverb

BANK ROM 006 AMBIENCE

Ambience completely violates the rules of physics! It can create the vastness of large rooms without letting the sound "perish" due to a long reverb tail. This effect is particularly well suited for lending more assertiveness to solo instruments and voices.

REV EQ

DRY controls the level of the direct signal, while **FX LVL** controls the effect volume. Together, they determine the mix ratio, provided mix mode is set to **INTERNAL**.

SIZE (reverb room size) determines the size of the simulated space that has an effect on the maximum decay time (adjusted using **DECAY**). With **PREDLY** (reverb predelay), you can delay the point at which the reverb tail engages. **DIFF** (diffusion) determines the reverb's density. **SPREAD** (spread of reverb tail) influences the distribution of the reverb tail. The higher the value, the less linear the distribution.

REV EQ

You can adjust the equalizer parameters: **LO CUT** determines the frequency of the high pass filter, **HI FREQ** and **HI GAIN** adjust the frequency and the lowering of the shelving filter.

BANK ROM 007 GATED REVERB

The effect of an abruptly ending, dense decay is in this case achieved without the disturbing quality of the level-dependent noise gate. This way, entire drum sets can be adjusted together, giving your mix amazing density.

The **ATTACK** parameter (EDIT page 1) influences the density of the reflections at the beginning of the reverb tail. The lower the value, the more abrupt the increase. **DENS** (density) defines the echo density of the reverb tail before it is abruptly cut off. The functions of the remaining parameters are identical to those of the ambience effect.

BANK ROM 008 REVERSE REV.

This algorithm simulates a reverb tail played backwards.

REV EQ

RISE (rise time) on the first EDIT page determines the steepness of the reverb tail curve before the abrupt end of the reverb tail.

REV EQ

The parameters **LO CUT**, **HI FREQ** and **HI GAIN** control the filter section located ahead of the actual reverb effect.

BASS (bass multiply) controls the reverb time for the bass (depending on the **DECAY** time); with **BASS F** (Bass Frequency) you control the upper cut-off frequency of the low-frequency reverb segment.

4.5 Delay

BANK ROM 009 DELAY

Here you have an extensive delay that lets you create a vast array of interesting reflection patterns. The input signal's highs and lows can be adjusted using the shelving filter, whereby you can simulate the sound of old "vintage delays". As the effect routing indicates, this algorithm consists of two independent stereo delays, whose parameters can be individually adjusted.

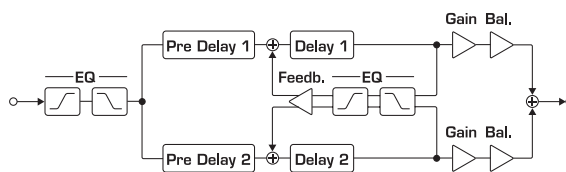

Fig. 4.5: Effect design of delay algorithm

MIX DL1 DL2 FDB

The **DRY** and **FX LVL** (effect level) parameters control the mix ratio. **DRY** determines the level of the direct signal, while **FX LVL** controls the effect volume.

A 2-band equalizer (EQ) is located ahead of the stereo delays. **LO FREQ** (low frequency)/**LO GAIN** (low gain) determine the frequency and the level of a bass filter, and **HI FREQ**/**HI GAIN** control the treble level.

MIX DL1 DL2 FDB

The parameters for delay 1 are adjusted on this page. The **PREDLY** (pre delay) parameter controls a separate delay that is not part of the feedback loop. **DELAY 1** (delay time) determines the delay time within the feedback loop. Very interesting effects can be created through this partition. With **FEEDB** (feedback amount), you can adjust the degree of feedback. Negative values produce reverse-phase feedback.

GAIN 1 determines the output level, and **BAL 1** (balance) determines the position of the delayed signal in the stereo image.

MIX DL1 DL2 FDB

The second delay is designed identically to delay 1. Here, too, there is a pre-delay located ahead of the feedback loop. **DELAY 2** (delay time) determines the delay time of main delay. The parameters **FEEDB**, **GAIN 2** and **BAL 2** have the same function as in Delay 1.

 The time values of delay 1 and delay 2 can alternatively be adjusted by tapping the TAP key. The key LED blinks rhythmically in the tempo of the delay time you adjusted.

MIX DL1 DL2 FDB

An equalizer (EQ) is integrated in the feedback paths of both delays. This equalizer lets you filter the signal in the feedback path. All filter settings of this section have an effect of both delay feedbacks.

The equalizer consists of two shelving filters; **LO FREQ** (low frequency)/**LO GAIN** (low gain) process the bass filter, while **HI FREQ**/**HI GAIN** adjust the frequency and the level of the treble filter.

4.6 XOver Delay

BANK 010 ROM XOVER DELAY

The input signal is divided into bass, mids and highs. The elements of the individual frequency bands can be assigned to three separate stereo delays with separate levels. This way, interesting reflexion patterns can be produced.

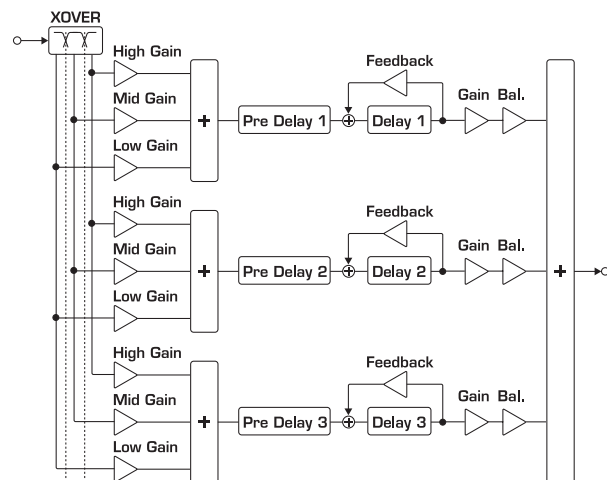

Fig. 4.6: Effect design of the Xover delay effect

MIX DL1 DL2 DL3

The mix ratio between the effect and the dry signal is controlled with the **FX LVL** (effect level) and **DRY** parameters. **DRY** is not available in the **EXTERNAL** mix mode (pre-adjustable in setup) as well.

The crossover parameters can also be adjusted. **HI TYPE** (high filter type) determines the slope of the crossover between the high and mid frequency bands. You can select between 6, 12 and 18 dB per octave. The split frequency of this filter is adjusted using **HI FREQ** (high split frequency).

LO TYPE (low filter type) determines the slope of the lower filter (6, 12 and 18 dB per octave). The crossover frequency for this filter is adjusted using **LO FREQ** (low split frequency).

MIX DL1 DL2 DL3

Each one of the three delay modules has its own **EDIT** page. Because the functions are basically the same, we will only describe them once.

Next, you can determine how much of the signal from each individual frequency band will be added to the delay section. The parameters **LO GAIN** (low input gain), **MD GAIN** (mid input gain) and **HI GAIN** (high input gain) are used for this purpose.

The **PREDLY** (pre delay) parameter determines the delay time of a special delay that is not part of the feedback loop. With **DELAY (1, 2, 3)** you can adjust the delay time of the delay sections and can also be entered using the TAP key. With **FEEDB** (feedback amount) you can vary the amount of feedback. Negative values produce reverse-phase feedback.

The output signals of the delay units can be mixed with **GAIN (1, 2, 3)** and positioned within the stereo image using **BAL 1, 2, 3** (balance).

4.7 Chorus/flanger

BANK 011 ROM CHORUS/FLAN.

The chorus/flanger effect can operate in 4 different modes: stereo chorus, 4, 6 and 8-voice chorus. Additionally, the signal whose pitch has been modulated can be fed back to the input, whereby flanger effects can be created.

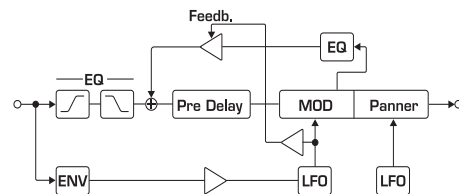

Fig. 4.7: Effect design for chorus/flanger

MIX LFO FDB ENV

The **MIX** (effect mix) parameter controls the effect-mix ratio. A value of 0% reproduces only the input signal; a value of 100% reproduces only the effect signal. Hint: mixing the input signal and the out-of-tune signal makes the chorus effect even more intensive. The effect is at its strongest with values between 40 and 60 percent.

The input signal's bass and treble frequencies can be filtered using the 2-band equalizer (EQ). **HI FREQ**/**HI GAIN** and **LO FREQ**/**LO GAIN** can be used.

Using **MODE**, you can select the operating mode for chorus. **STEREO** (stereo chorus), **QUAD** (4-voice chorus), **HEXA** (6-voice chorus) and **OCTA** (8-voice chorus) can be selected. With the **GAIN** (output gain) parameter you can correct the output volume of the effect block (engine). The **ST SPR** (stereo spread) parameter defines the stereo width of the effect signal between mono signal (0%) and maximum stereo width (100%).

MIX LFO FDB ENV

A very essential element of any chorus/flanger effect is its LFO (low frequency oscillator), which is used for creating modulations. The **SPEED** (modulation speed) parameter controls the modulation's velocity. This value can alternatively be entered using the TAP key.

With chorus/flanger, the modulation's delay time influences the intensity of the effect. This value is set up using **MODDLY** (modulation delay). Short times create a more subtle effect, while longer delays produce stronger pitch variations.

V-VERB PRO REV2496

There is a delay located ahead of each chorus voice. The middle pre-delay time is set up using **PREDLY** (pre delay). The **DLYSPR** (pre delay spread) determines the extent to which delay times of individual chorus voices vary from one another. When you select 0% as the value, all chorus voices are pre-delayed with the same amount of **PREDLY** time.

The **WAVE** (LFO waveform) parameter describes the wave form for the tone pitch modulation. Wave forms can be crossfaded from triangle-shaped (0) to sinusoidal (50).

PHASE (LFO phase spread) and **SPREAD** (LFO frequency spread) parameters are adjusted with the same control. They control either the phase length or the LFO frequency of the individual chorus voices. In **PHASE** mode (the potentiometer points between the left-most position and the middle), all LFOs have the same frequency, and the phase difference of the individual LFO generators can be adjusted between 0° (no phase difference) to 180° (maximum phase difference). When in **SPREAD** mode (the potentiometer lies between the middle and the right-most position), you can determine the extent to which the LFO frequency (adjusted with **SPEED**) between individual chorus voices will vary. In the middle position (0%), all LFOs run synchronously.

The chorus effect features the so-called auto-panning function. This way, you can shift the individual chorus voices around from left to right in the stereo image. With the **PAN** (panning mode) parameter, you determine the auto-panning operating mode. You can select between OFF, SYNC and RAND. When set to SYNC, all chorus voices are shifted by the same frequency in the stereo image. RAND (random) shifts each chorus voice with a somewhat different velocity. OFF deactivates this function. The **PANSPD** (panning speed) parameter controls the median panning speed.

MIX LFO FDB ENV

The flanger effect is produced when the modulated signal is fed back to the input signal through a feedback loop. The **FEEDB** (feedback amount) parameter controls feedback intensity. Negative values produce reverse-phase feedback.

Two shelving filters are integrated into the feedback loop. These shelving filters are used to filter the signal that is fed back into the input signal. **LO FREQ** (low frequency) and **LO GAIN** (low gain) process the bass frequencies, while **HI FREQ** (high frequency) and **HI GAIN** (high gain) set up the frequency and the attenuation of treble frequencies. The graphic representation of this page shows the resulting frequency distribution.

CROSSF (cross feedback amount) is a unique function that lets you feed back both channels in a crisscross fashion, i.e. from the right to the left channel and vice versa. A value of 100% results in the effect signal of the left channel being exclusively fed into the right channel and vice versa. This parameter is dependent on the previously set feedback intensity.

With **LFOMOD** (LFO feedback modulation amount) parameter, you can modulate the volume of the feedback signal. When you set this parameter to the maximum, you get volume variation between zero and the value set with **FEEDB**.

MIX LFO FDB ENV

The median LFO speed can also be influenced through the input signal level (so-called auto modulation). Using the **LFOMOD** (envelope to LFO speed modulation) parameter on the envelope page, a maximum increase of the LFO speed is determined by the signal volume. The **ATTACK** (attack time) parameter controls how quickly the LFO speed increases when the signal volume goes up. **HOLD** (hold time) determines how long the LFO speed is kept constant when the signal volume begins to decrease. **RELEASES** (release time) determines how quickly the LFO frequency decreases after the HOLD time ends.

4.8 Phaser

BANK 012
ROM
PHASER

This algorithm can create different kinds of typical phaser effects. The number of phase shifting stages used can be set to between 4 and 12.

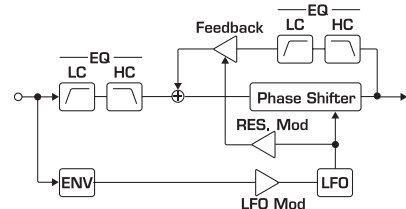

Fig. 4.8: Phaser effect design

MIX LFO ENV

The **MIX** (effect mix) controls the mix ratio between the dry signal (0%) and the effect signal (100%). The phaser effect is intensified through the mix between the input signal and the out-of-pitch signal. The effect comes through most powerfully when the **MIX** value is set between 50 and 70 percent.

A combination of the high pass filter and the low pass filter reduces the bandwidth of the input signal. These filters are controlled with **LO CUT** (low cut frequency) and **HI CUT** (high cut frequency).

Using **STAGES**, you can set up the number of phase shifting stages used. You can select between 4 and 12 stages. **RESON** (resonance) controls how much feedback the effect signal produces at the input. Two filters are also integrated in the feedback loop. **RES HC** (resonance high cut frequency) determines the frequency of a low pass filter, while **RES LC** (resonance low cut filter) sets the frequency of a high pass filter.

With **GAIN** (output gain), you can correct the output volume of the effect block (engine).

MIX LFO ENV

SPEED (modulation speed) determines modulation speed and can also be entered using the TAP key.

The **WAVE** (LFO waveform) parameter can be used to lengthen the upper or the lower alternation of the LFO triangle oscillation. Negative values lengthen the lower alternation; positive values lengthen the upper alternation. The influence of these parameters on the wave form is clarified on the GRAPH page.

PHASE (LFO phase spread) and **SPREAD** (LFO frequency spread) parameters are adjusted by the same control. They control the phasing or the frequency of both LFOs for the left and right channels. In **PHASE** mode (the potentiometer points to the left of its middle position), the LFO frequency remains unchanged, while the phase difference can be set to values between 0° and 180°. When the potentiometer points to the right of its middle position (**SPREAD** mode), the LFO frequency deviation in both channels is controlled. At 0%, both LFOs operate at the same frequency (set with **SPEED**), while 100% creates a maximum deviation of both LFO frequencies.

RANGE (sweep range) defines the maximum phase shift. With **DEPTH** (LFO modulation depth), you can set the phase shift modulation depth through the LFO. A value of 100% means that the LFO modulates the phase shift between the value set using **RANGE** and the minimum value.

With **COLOR**, you can determine the characteristic of the phase-shifted sound. A low setting creates the sound of a standard phaser, while higher values lead to more intensive sound effects.

The LFO can be used to modulate feedback intensity. With **RESMOD** (LFO feedback modulation amount), you determine how much LFO will affect the **RESON(ANCE)** parameter (EDIT page 1). Positive values result in feedback being increased as the frequency increases; negative values result in feedback being lowered as the frequency increases.

MIX LFO ENV

The LFO speed can also be modulated through the volume of the input signal. The **LFOMOD** (envelope to LFO speed modulation) parameter determines how much the LFO will be influenced by signal strength. The **ATTACK** (attack time) parameter controls how quickly the LFO speed is increased when signal volume increases erratically. **HOLD** (hold time) determines how long the LFO frequency should be kept constant when the signal volume starts decreasing. **RELEAS** (release time) determines how quickly the LFO frequency will be decreased after the **HOLD** time expires.

4.9 Tremolo

BANK ROM 013 TREMLO

This is a typical tremolo/panner algorithm with a couple of interesting extra features built in.

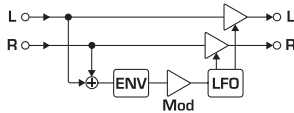

Fig. 4.9: Design of the tremolo effect

LFO ENV

SPEED (modulation speed) determines modulation speed. Entering this parameter via **TAP** makes this process very intuitive. The **WAVE** (LFO waveform) parameter determines the wave form for amplitude modulation. In doing so, the wave form can be cross-faded from triangle-shaped (1) to sinusoidal (50) all the way to square wave form (100). Editing the **WAVE** parameter is much easier in the graphical editing mode. With **PHASE** (LFO phase), you can set modulation phase length of the right channel compared to the left channel. The available parameter range is between -180° and $+180^\circ$.

MIX (effect mix) controls the depth of amplitude modulation. **GAIN** (output gain) lets you correct the output volume of the effect block (engine).

LFO ENV

The median LFO speed can also be modulated through the input signal level. In doing so, the **LFOMOD** parameter (envelope to LFO speed modulation) determines how strongly the LFO is influenced by signal volume. The time parameters **ATTACK** (attack time), **HOLD** (hold time) and **RELEAS** (release time) control how quickly the LFO speed will increase when the signal volume increases, how long it will be held and how quickly it will decrease after the **HOLD** time expires.

4.10 Compressor

BANK ROM 014 COMPRESSOR

This is a very complex compressor algorithm with two basic operating modes: peak compression and RMS compression. A multimode filter side chain lets you use only certain frequency ranges for calculating the control signal. Additionally, a crossover is available for compressing only a certain segment of the frequency spectrum. Its possible applications are the de-esser and bass compressor/enhancer.

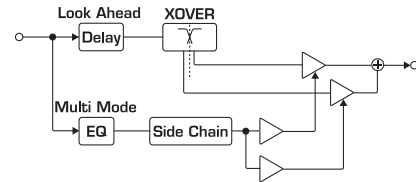

Fig. 4.10: Compressor design

DYN FLT

The **ATTACK** (attack time) parameter determines the time that the compressor needs to react to signals that exceed the signal level set with **THRESH(HOLD)**. **HOLD** (hold time) determines how long the signal level is reduced after the signal volume drops below the threshold value. **RELEAS** (release time) determines how quickly the compression will ease up after the **HOLD** time ends.

With **THRESH** (compression threshold), you can determine the minimum signal level for deploying compression. **RATIO** (compression ratio) determines the compression rate once this threshold is exceeded. The **KNEE** (soft knee) parameter can be used to smoothen the curve changeover from an uncompressed to a compressed signal. A value of 0 deactivates this function (hard knee), and 10 produces maximum smoothening of the curve. The **GRAPH** page indicates the compression line and the signal level reduction.

With **M-GAIN** (make-up gain), you can correct the output volume of the compressed signal.

With **LOOKAH** (look ahead delay), you can delay the audio input relative to the side chain path. For example, this can be used together with longer attack times because the side chain has more time to lower the signal level, which can produce quite interesting effects. Please note that this also delays the overall output signal of your REV2496.

DYN FLT

With **FILTER** (side chain filter mode), you can select the type of side chain filter. When set to **OFF**, the filter is inactive. Additionally, you can select one of these: **LP12dB** (low pass filter with 12 dB decrease per octave), **HP12dB** (high pass filter with 12 dB per octave), **LO SHV** (low shelving filter), **HI SHV** (high shelving filter) and **BP** (band-pass filter). Depending on the filter type you select, **FREQ** (frequency) determines the center frequency of the filter. **GAIN** determines the level of the shelving filters, and **Q** determines the bandwidth of the band-pass filter.

With the **MODE** (compression mode), you can select the basic type of compression. **PEAK** measures the current, maximum signal strength, while **RMS** detects the average signal energy. In **RMS** mode, the length of integration window can be set to values between 1 to 20 ms (milliseconds).

The transient bypass function gives you the option to exclude the short-time transients from compression in the audio signal. The **TRANS** parameter defines the maximum length of the transients that will remain unaffected by compression.

V-VERB PRO REV2496

X-MODE (Xover filter mode) determines the operating mode of the crossover filter. When set to WIDE, the entire spectrum is compressed. When set to LO 6 dB, LO 12 dB and LO 18 dB, only the output signal of the low pass filter is compressed. When set to HI 6 dB, HI 12 dB and HI 18 dB, only the output signal of the high pass filter is processed. The filters have a selectable change rate, with values of 6, 12 or 18 dB per octave. **X-FREQ** (Xover split frequency) in this case determines the cut-off frequency of the low pass filter and the high pass filter.

With this function you can for example process only the bass frequencies of a stereo mix, and leave treble unaffected. You can also configure a 2-band mastering compressor by selecting this algorithm for both engines and configuring it as a combination effect in parallel 5-routing. Now, select a LO value in engine 1 for X-mode; select a HI value in engine 2. The compressor in engine 1 now processes the lower frequency band, while high frequencies are compressed in engine 2. This way, you can compress the lows and the highs with different intensity, and you can set control response times separately for both frequency bands.

5. APPLICATIONS

The BEHRINGER V-VERB PRO is an extremely flexible reverb processor. Thanks to its extensive connectivity options, it can be used in a large number of different applications. In this chapter, we will describe and present some application possibilities.

5.1 Using the V-VERB PRO in the aux bus

The standard application for a reverb processor. Using the REV2496 in the aux bus lets you feed signals from one, several or all channels of your console into the V-VERB PRO. When miking a drum kit, for example, you can use the aux controls to adjust the reverberation independently for each microphone. Thus, you are able to assign a stronger reverb to the snare than to the toms. Wiring the V-VERB PRO in the aux bus should be done as follows:

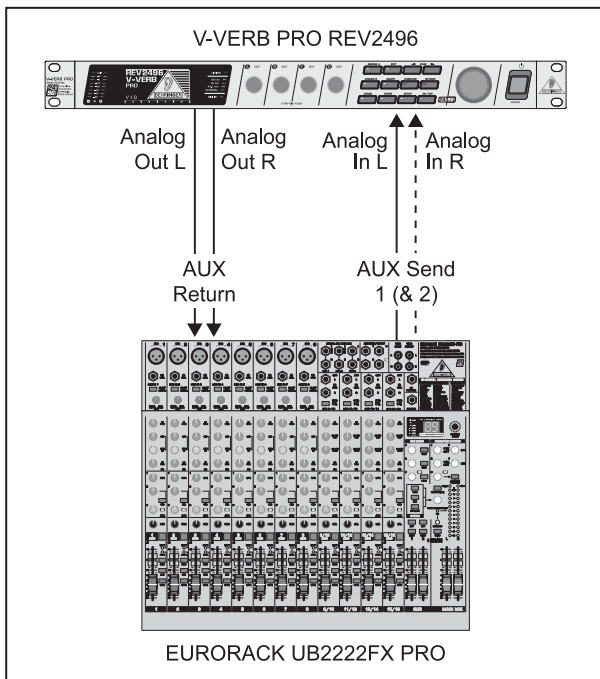

Fig. 5.1: Wiring aux busses of a mixing console

| SETUP | |
|--------------|----------------------------|
| Routing | Parallel 5, 6; Serial 1, 2 |
| Master Input | analog |
| Wet Dry Mix | external |

Tab. 5.1: SETUP configuration for wiring the REV2496 via aux busses

Connect the input of the V-VERB PRO to the aux send output of your mixer. The REV2496's outputs are connected to an available aux return input or a stereo input of your mixer. As a matter of principle, effects processors should always be connected to post fader aux busses, i.e. independent of the fader position.

☞ If your mixing console has aux busses that feature **one jack for the aux send**, you have to always use the left input of the REV2496. In this case, set "Input Mode" on the I/O page to mono (see chapter 3.8.1).

☞ To avoid damage to your equipment, turn down the volume level on your amplifier when making connections. Turn off all the equipment that you want to connect to one another until all connections have been made as described.

An example: say you want to run your REV2496 in a live situation in connection with a mixing console. An ambiance effect should lend some more roominess to a drum.

Connect the V-VERB PRO (as described previously) to your mixer (fig. 5.1). Switch the REV2496 on. In the SETUP menu (I/O page), activate "EXTERNAL" operation. Press one of the ENGINE keys, select the ambiance effect (ROM 006) using the PRESET WHEEL and confirm with OK/TAP. The effect is now activated. Using aux return, adjust the overall level of the effect. Slowly turn up the aux send controls in the individual mixer channels until each of the drum signals becomes the desired amount of the effect mixed to it. Then, you can do some fine-tuning in the EDIT mode.

5.2 Using the V-VERB PRO in the insert path

Generally, you can use your REV2496 on channel or subgroup inserts, using a standard insert cable. Connection to a channel insert makes sense when you want to process very specific signals (e.g. vocals) with the V-VERB PRO, or when aux inserts on your mixer are already used up by other equipment. For the compressor algorithm (ROM 014), this is the correct selection. If you wish to use another effect, you should set the wet/dry mix in the I/O-Setup to "INTERN", so that you can comfortably mix the effect signal with the FX level (EDIT D), and the dry direct signal with the DRY (EDIT D, upper row).

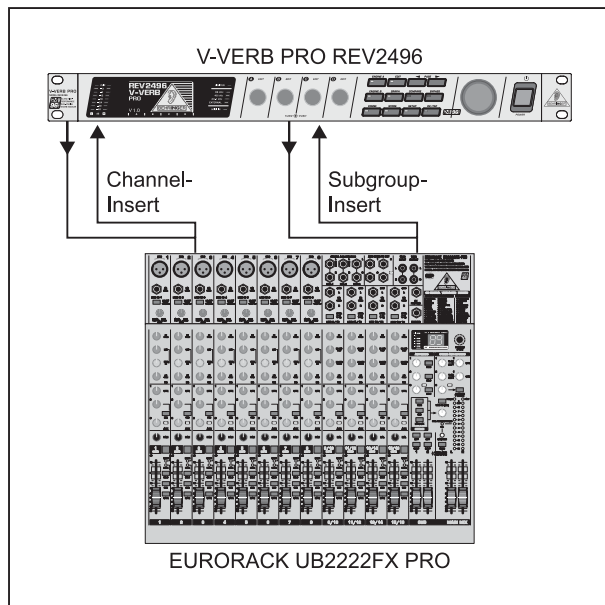

Fig. 5.2: Wiring the V-VERB PRO in the insert path

| SETUP | |
|--------------|---|
| Routing | Parallel 1, 3 (only left input), Serial 1 |
| Master Input | analog |
| Wet Dry Mix | internal |

Tab. 5.2: SETUP settings for wiring the REV2496 in the insert path

5.3 The V-VERB PRO as a guitar effects processor

Through its extensive MIDI implementation, V-VERB PRO can also be used as a multi-effects processor in a guitar rack. The illustrations that follow show how you can use your REV2496 in a guitar setup.

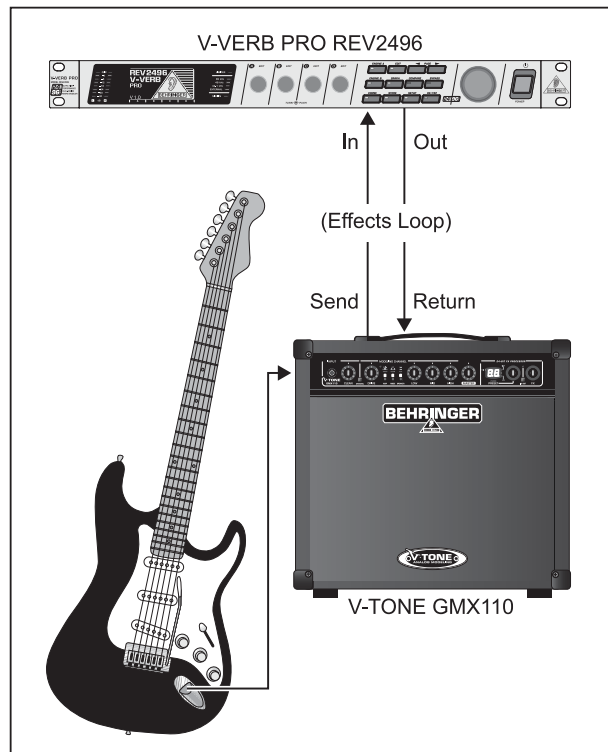

Fig. 5.3: The REV2496 in connection with a guitar amp

In this example, the V-VERB PRO should be inserted between the preamplifier and the output stage of your amp. Almost all guitar amps offer an insert or an effects loop, so that the preamplifier signal of your amp can be tapped into in order to bring it to the audio input of your effects equipment. The preamplifier signal is processed in the REV2496, and then sent back to the output stage of your amp via the amp's return path.

If you use a stereo rack system for amplification, you can also wire your REV2496 in stereo. Connect the preamp to the audio inputs of your V-VERB PRO. Connect the outputs (left/right) to one channel of your amp.

| SETUP | |
|--------------|----------------------------|
| Routing | Parallel 1, 3, 5; Serial 1 |
| Master Input | analog |
| Wet Dry Mix | internal |

Tab. 5.3: SETUP settings for wiring the REV2496 as a guitar effects processor (serial inserts)

⚠ Since most guitar amps only feature a serial effects loop, you should make sure that the REV2496 is set to Mix Internal mode. In Mix Internal mode, you can control the effects intensity that is applied to the guitar signal. If, however, your amp is equipped with a parallel effects loop, which allows adding the effects signal portion (similar to an aux bus in a mixing console), then you should set the REV2496 to Mix External mode. In this case, the effects intensity present at the outputs of the V-VERB PRO is 100%.

| SETUP | |
|--------------|----------------------------|
| Routing | Parallel 1, 3, 5; Serial 1 |
| Master Input | analog |
| Wet Dry Mix | external |

Tab. 5.4: SETUP settings for wiring the REV2496 as a guitar effect processor (parallel insert path)

V-VERB PRO REV2496

5.4 The V-VERB PRO in digital environment

Thanks to its exhaustive set of digital connections, the REV2496 is almost predestined for use in a complete digital setup. This way, you eliminate unnecessary signal conversions that may degrade the quality of your sound.

When connected to a digital mixing console (in our example the BEHRINGER DDX3216), a typical setup could look like this:

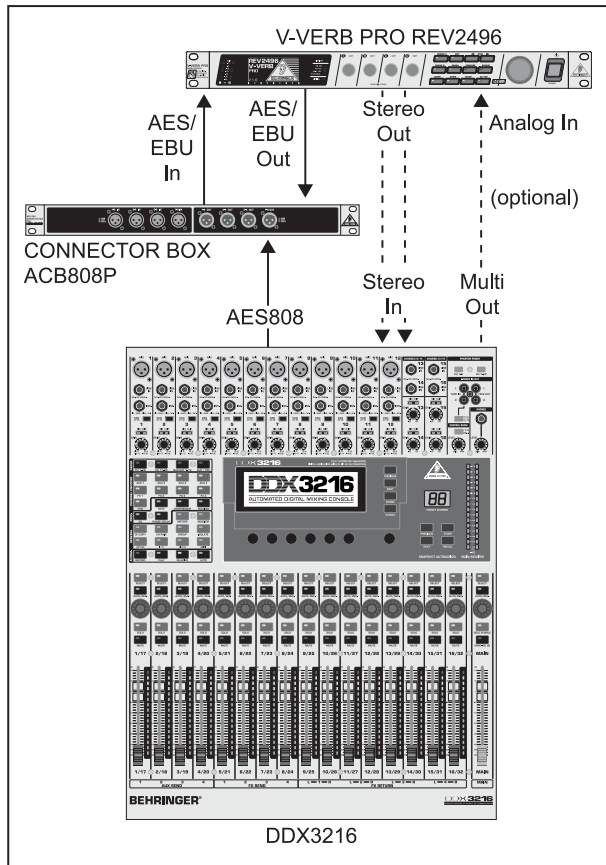

Fig. 5.4: V-VERB PRO and DDX3216

Connect your digital mixer to the digital inputs of the REV2496. Since the REV2496 features both optical and XLR connections, you are ready for practically all situations.

| SETUP | |
|--------------|--------------------------------|
| Routing | Parallel 2,3,5,6; Serial 1,2,3 |
| Master Input | digital |
| Wet Dry Mix | extern |
| Clock Source | Digital In |
| Input Source | XLR |

Tab. 5.5: SETUP settings for wiring the REV2496 to a digital mixing console

It can even be configured to function as a 4-channel setup if your mixer features additional analog connectors that can be configured as aux sends and returns. Depending on the selected configuration, you can simultaneously route one or two signals to the REV2496, and use one or both outputs with separate or mixed signals.

| SETUP | |
|--------------|----------------------------------|
| Routing | Parallel 1, 2, 3, 4; Serial 3, 4 |
| Master Input | depending on the configuration |
| Wet Dry Mix | external |
| Clock Source | depending on the configuration |
| Input Source | depending on the configuration |

Tab. 5.6: SETUP settings when using the REV2496 in a 4-channel setup

5.5 The V-VERB PRO in 4-channel operation

Your REV2496 truly shines in 4-channel operation, when its extensive connectivity options and configuration possibilities really come into play. Using an external A/D-D/A converter, you can use all four connectors at the same time, offering utmost flexibility. Our ULTRAMATCH PRO SRC2496 is used in this application as a converter for the digital connectors of your REV2496.

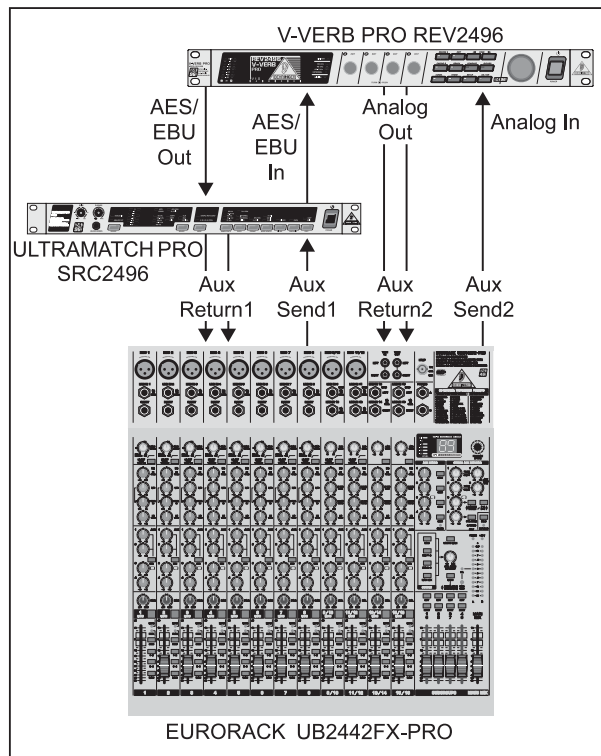

Fig. 5.5: V-VERB PRO in 4-channel operation with an external A/D-D/A converter

| SETUP | |
|--------------|----------------------------------|
| Routing | Parallel 1, 2, 3, 4; Serial 3, 4 |
| Master Input | depending on the configuration |
| Wet Dry Mix | external |
| Clock Source | depending on the configuration |
| Input Source | depending on the configuration |

Tab. 5.7: SETUP settings for connecting the REV2496 to an A/D-D/A converter

👉 If you use a digital mixer as a “Clock Master” and want to use the digital audio connections only for synchronization, set the clock source on your REV2496 to DIG. IN and the input source to XLR or OPT. (depending on the type of the desired connector). If you for example wish to use a central “Studio Master Clock” generator, you can carry out the synchronization via the wordclock input (BNC) as well. In this case, select WDCLK on your REV2496 as the clock source. On the other hand, if the REV2496 acts as the “Clock Master,” one of the three possible sampling frequencies (44.1, 48 or 96 kHz) has to be selected in SETUP on the DIG1 page.

6. MIDI FUNCTIONS

MIDI (Musical Instruments Digital Interface) lets several musical instruments/devices communicate using a standardized connector. Units with MIDI connectors speak the same language so that an entire network of several MIDI units can be created.

For example, you can wire your V-VERB PRO like this:

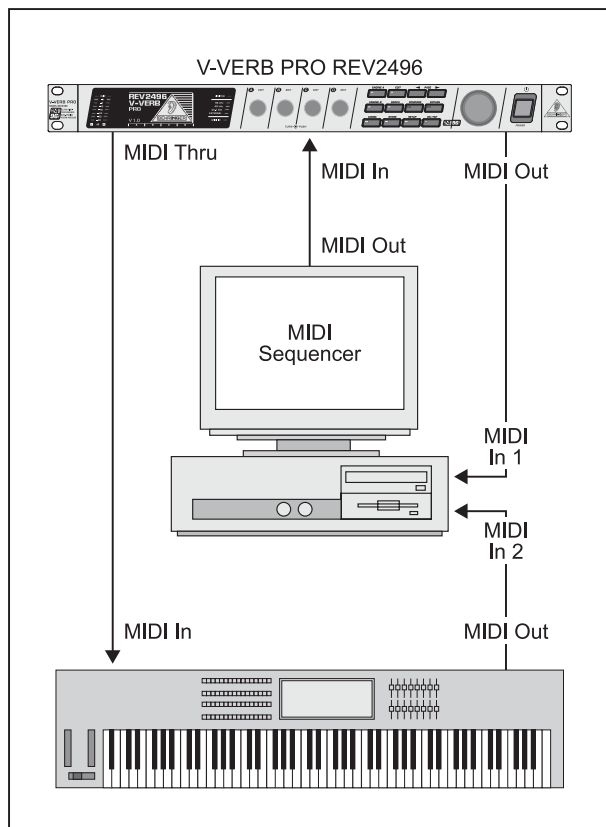

Fig. 6.1: V-VERB PRO in a MIDI connection with a sequencer (computer) and a keyboard

All MIDI commands that are sent to the REV2496 are received through the **MIDI IN connector**. If for example you wish to integrate the REV2496 in your studio, you can connect your sequencer to the MIDI In connector, which will allow you to control your REV2496. The **MIDI THRU connector** is used for forwarding incoming MIDI commands. This means that all control commands that get into the V-VERB PRO through the MIDI IN connector can be passed onto other MIDI-enabled equipment or instruments using the MIDI THRU connector. With the **MIDI OUT connector**, you can generally send MIDI data from the REV2496.

Different kinds of equipment functions can be controlled via MIDI. MIDI messages are received on another MIDI-enabled device (e.g. a MIDI sequencer or a MIDI foot controller). The MIDI messages that need to be sent have to be set in the MIDI sequencer. The MIDI functions contain program-change commands (program changes), controller messages and an abundant SysEx implementation (system-specific data). Using program changes, you can switch presets. Controlling individual effect parameters in real time is carried out by the controller. Transmitting the entire memory contents for backup purposes is done by performing a SysEx dump.

Separation into 16 MIDI channels lets you control up to 16 different pieces of equipment/instruments within a single MIDI network. In the case of the REV2496, you can select different MIDI channels for engine A, engine B and COMBI. This way, MIDI data can be separately addressed for each engine. The advantage of doing this is that incoming program changes won't switch all programs but only those in the respective engine.

6.1 MIDI settings



Fig. 6.2: MIDI SETUP page

All MIDI settings are carried out on the MIDI page in the setup menu. Pressing the SETUP key once gets you to the setup menu. Using PAGE ►, scroll until you get to the MIDI page.

First you need to set the MIDI channels for engine A, B and COMBI. You can use the controls indicated in the upper row of the display for this purpose. You can select the desired MIDI channel by turning the controls A to C.

Now you can select what kinds of MIDI program changes will be sent and received. Different kinds of program changes include parameter change (PGM), controller (CC) and system-specific data (SX). These can be set up both on the send (SEND) and on the receiving (RECEIVE) end. The table below shows which settings are possible:

| Display | Mode |
|---------|---|
| OFF | neither sends nor receives data |
| PROGR. | sends and receives only program changes |
| CONTR. | sends and receives only controls |
| SYSEX | sends and receives only SysEx data |
| PGM+SX | sends and receives program + SysEx data |
| PGM+CC | sends and receives program + controller |
| CC+SX | sends and receives controller + SysEx |
| ALL ON | sends and receives all data |

Tab. 6.1: MIDI function groups

6.2 Program changes

Program changes let you call up presets via MIDI. Because of the MIDI data structure, 128 program numbers can be sent. However, the V-VERB PRO features more than 400 memory locations. These are subdivided into 2 banks for both engines (A and B) as well as for the combination presets (ROM and USER bank). There are 100 memory slots within each memory bank. To load up a preset from another memory bank, before sending program changes you first have to select a memory bank. This is done by sending a bank-select command (controllers 0/32) with the value 0 (for the ROM bank, i.e. factory presets) or with the value 1 (for the USER bank). You should set the combination effects to another MIDI channel in order to avoid conflicts with the program switching for the engines. Here, too, you can use the bank select function with the controllers 0/32.

6.3 Controller commands

All parameters of the effect processor can be modified in real time via MIDI. To do this, the so-called non-registered parameter numbers (NRPNs) are used, i.e. each parameter of the REV2496 is assigned its own NRPN. You can get more detailed information about this subject on the internet as a download from our homepage www.behringer.com.

V-VERB PRO REV2496

6.4 Backing up data via MIDI

To save all of your presets outside of your V-VERB PRO in just one step, you can use a special form of MIDI communication: system-exclusive data. Here, the V-VERB PRO lets the sequencer or the MIDI file know who its manufacturer is, what type of equipment it is and transmits all parameter settings for all presets. To activate this very practical function, please go the SETUP mode by pressing the SETUP key. Use PAGE ◀/▶ to get to the MIDI page. Activate the SysEx function by using the SEND parameter (EDIT B) (see table 6.1).

Now, by turning the EDIT D controller, you can determine if the entire memory contents (ALL) or only the current setting (EDIT) will be sent.

Select a track on your MIDI sequencer, put it into recording mode, start the recording and press the EDIT D control to start the dump. Now, your V-VERB PRO transmits its memory contents as system-exclusive data.

To load up this recorded data back to the REV2496, you have to first activate the SysEx function on the receiving end. This is done through the EDIT C control (select SYSEX, PGM+SX, CC+SX or ALL ON). The REV2496 can now receive data. Start your MIDI sequencer, and the preset data will be automatically loaded into the internal memory. Upon being received, a preset previously recorded on the MIDI sequencer will automatically be stored in its old location, and this will happen without a confirmation being given about it.

 During receiving/loading memory data, the entire current memory contents of the USER bank will be overwritten.

7. INSTALLATION

7.1 Installation in a rack

The REV2496 requires one height unit (1 HE) for mounting in a 19" rack. Please keep in mind that an additional 10 cm (4") of depth in the back are required to enable trouble-free access to the connectors on the rear panel.

Please make sure that your REV2496 has enough cooling air, and never put it on an amp or other heat-emitting equipment to avoid overheating.

For rack installation, please use M6 machine screws and nuts.

7.2 Audio connections

You will require different cable types for different types of applications. The illustrations that follow show you how these cables are connected. Always use only good-quality cables.

The analog connections [19] and [20] of your REV2496 are laid out as balanced connection to avoid hum.

You can also connect equipment with unbalanced connections to the balanced inputs and outputs of your REV2496. Use either mono jacks or connect the ring of stereo jacks with the shaft (or connect Pin 1 to Pin 3 for XLR connectors).

Balanced XLR connectors

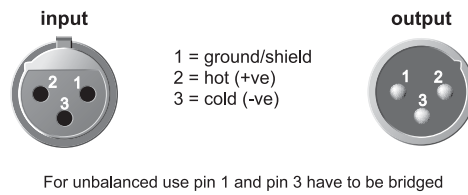

Fig. 7.1: XLR connections

Unbalanced 1/4" TS connector

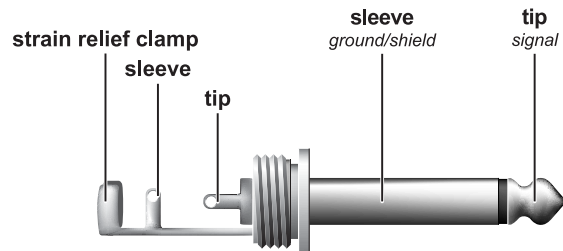

Fig. 7.2: 1/4" TS connector

Balanced 1/4" TRS connector

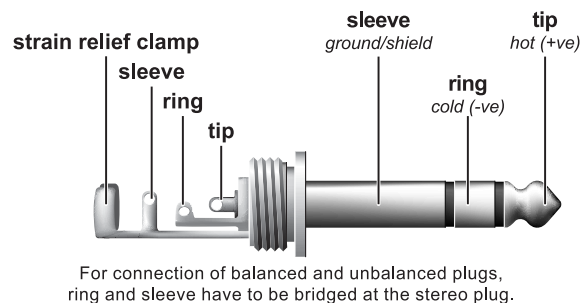

Fig. 7.3: 1/4" TRS connector

7.3 Digital inputs and outputs

The AES/EBU interface whose name is derived from the Audio Engineering Society and the European Broadcasting Union, is mainly used in professional studio environments and broadcasting studios for the transmission of digital signals over longer distances. The connection is made via balanced XLR cables with a resistance of 110 ohms. Cables can be up to 100 m long. With some minor adaptations, even cable lengths of over 1 km are possible (not rare in radio and TV applications). According to our own experience, cable selection does not play a major role. With cables whose length does not exceed 20 m (66 ft), commercially available microphone cables don't have a negative effect on sound quality. When dealing with greater cable lengths or when the quality standards are set higher (mobile operation, stronger high-frequency fields), you should definitely use special 110-Ohm cables with double electromagnetic shielding.

The interface complies with the AES3 format, which allows for two-channel transmission of signals with a resolution of up to 24 bits. The signal has an auto-clock and auto-synchronization feature (important when several digital devices are used). The sample rate is not fixed and can be chosen freely. Typical rates are 44.1 kHz, 48 kHz, 88.2 kHz and 96 kHz. The AES/EBU interface is largely compatible with the popular S/PDIF interface. A connection can be made using an adapter. The format can be switched to S/PDIF (Sony/Philips Digital Interface Format).

Digital inputs/outputs on optical connectors are also available.

7.4 WORDCLOCK connection

If several devices will be embedded into a digital recording system comprising, for example, a digital mixing console, all connected digital devices must be synchronized using a common wordclock signal. The REV2496 features a wordclock input, which can be used to control external equipment via wordclock signals. The input supports the sample rates 44.1, 48, 88.2 and 96 kHz, and can be activated **only if the analog inputs are used**.

The illustration that follows shows how the wordclock input is correctly connected. Since these are the same cables used by computer networks, accessories such as interconnecting cables T-connectors and terminating resistors can also be obtained in computer stores.

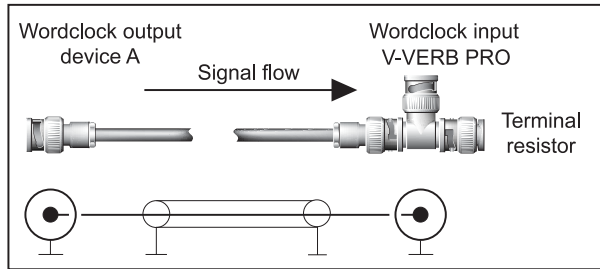

Fig. 7.4: End connection of the wordclock input

If the V-VERB PRO is placed within several pieces of daisy-chained equipment supplied with wordclock, it will be fed the wordclock signal via a T-connector, while the other end of the T-connector (and the BNC cable) facilitate connection to the next device in the chain. The last unit in the chain must be terminated with a T-connector and a 75-Ohm resistor. Some equipment features a switchable terminating resistor, eliminating the need for a terminal resistor and a T-connector.

7.5 MIDI connections

The REV2496 features an integrated MIDI interface that makes sending and receiving MIDI data possible. This way, your REV2496 can be optimally integrated into various recording studios. You can also control it using the sequencer on your computer.

The MIDI connections in the back of the REV2496 feature the standard 5-pin DIN connectors. You will need commercially available MIDI cable for connecting your V-VERB PRO with other MIDI equipment.

MIDI IN: This connection is used for receiving MIDI data. The receiving channel is set in the SETUP menu.

MIDI THRU: Incoming MIDI signal can be tapped into without modifications at the MIDI THRU connector. Several MIDI units can be daisy-chained this way.

MIDI OUT: Data can be sent to a computer connected to your REV2496 or to other MIDI equipment via MIDI OUT. Program data as well as status information for signal processing can be transmitted.

8. OPERATING SOFTWARE

The operating software of your V-VERB PRO REV2496 is constantly being developed to improve its performance and adapt the operation of the unit to user requirements. We would therefore be pleased to hear about your suggestions and ideas for improvement. We will try to include your suggestions in the next software revision. Information on new software versions are available from the trade press, your retailer, from our website at www.behringer.com or directly from BEHRINGER (Tel. +49 2154 9206 4166).

The current software revision of your V-VERB PRO REV2496 is briefly displayed in the start picture during start-up.

9. SPECIFICATIONS

ANALOG INPUTS

| | |
|------------------|--|
| Type | XLR balanced 1/4" TRS stereo balanced |
| Impedance | approx. 22 k Ω balanced |
| Max. input level | +16 dBu |
| CMRR | typ. 40 dB |

ANALOG OUTPUTS

| | |
|-------------------|---|
| Type | XLR, servo-balanced 1/4" TRS stereo servo-balanced |
| Impedance | approx. 100 Ω balanced |
| Max. output level | +16 dBu |

SYSTEM SPECIFICATIONS

| | |
|-----------------------|--|
| Frequency range | <10 Hz - 20 kHz @ 44.1 kHz <10 Hz - 22 kHz @ 48 kHz <10 Hz - 46 kHz @ 96 kHz |
| Signal-to-noise ratio | -90 dBu |
| Dynamic range | 106 dB (analog in \Rightarrow analog out) |
| THD | 0,007% typ. @ +4dBu, 1 kHz, Gain 1 |
| Crosstalk | < -100 dB (analog in \Rightarrow analog out) |
| Signal delay | < 1 ms (analog in \Rightarrow analog out) |

DIGITAL INPUT 1

| | |
|---------------------|------------------------|
| Type | XLR servo-balanced |
| Standard | AES/EBU or S/PDIF |
| input impedance | 110 Ω |
| nominal input level | 0.2 - 5 V peak-to-peak |

DIGITAL INPUT 2

| | |
|----------|-------------------|
| Type | TOSLINK optical |
| Standard | AES/EBU or S/PDIF |

DIGITAL OUTPUT 1

| | |
|----------|--------------------|
| Type | XLR servo-balanced |
| Standard | AES/EBU or S/PDIF |

DIGITAL OUTPUT 2

| | |
|----------|-------------------|
| Type | TOSLINK optical |
| Standard | AES/EBU or S/PDIF |

SYNC INPUT

| | |
|-----------------|-----------------------------|
| Type | BNC |
| Standard | Wordclock (1 x sample rate) |
| input impedance | approx. 50 k Ω |
| Nom. level | 2 - 6 V peak-to-peak |

MIDI Interface

| | |
|----------------|-------------------------------|
| Type | 5-pin DIN jacks In/Out/Thru |
| Implementation | cf. MIDI implementation chart |

DIGITAL PROCESSING

| | |
|-------------|--|
| Processor | high-resolution SHARC [®] DSP 600 MFLOPs, 32-bit internal signal processing |
| Converter | 24 Bit/96 kHz |
| Sample rate | external, 44.1 kHz, 48 kHz, 96 kHz |

V-VERB PRO REV2496

DISPLAY

Type 128 x 64 backlit liquid crystal display (green) with adjustable contrast

MEMORY

Presets 100 ROM + 100 user presets for engines A and B
100 ROM + 100 user presets for combinations

POWER SUPPLY

Mains voltage 85 – 250 V~, 50 – 60 Hz

Power consumption 10 W typ.

Fuse **T 1 A H**

Mains connector Standard receptacle

DIMENSIONS/WEIGHT

Dimensions 19" (482,6 mm) x 1 ¾" (44,5 mm) x 8 ½" (217 mm)

Weight approx. 4 ¾" lbs. (2.15 kg)

BEHRINGER makes every effort to ensure the highest standard of quality. Necessary modifications are carried out without notice. Thus, the specifications and design of the device may differ from the information given in this manual.

10. MIDI IMPLEMENTATION

| MIDI Implementation Chart | | | | |
|----------------------------|----------|----------|-------------|---|
| Function | Engine A | Engine B | Combination | Remarks |
| MIDI Channel | 1 - 16 | 1 - 16 | 1 - 16 | |
| Mode | No | No | No | |
| Note Number | No | No | No | |
| Velocity | No | No | No | |
| After Touch | No | No | No | |
| Pitch Bender | No | No | No | |
| Control Change | | | | see Control Change Documentation* |
| 0 | Yes | Yes | Yes | Bank Select MSB |
| 32 | Yes | Yes | Yes | Bank Select LSB |
| 6 | Yes | Yes | Yes | Data Entry MSB |
| 38 | Yes | Yes | Yes | Data Entry LSB |
| 96 | Yes | Yes | Yes | Data Increment |
| 97 | Yes | Yes | Yes | Date Decrement |
| 98 | Yes | Yes | Yes | Non Registered Parameter LSB |
| 99 | Yes | Yes | Yes | Non Registered Parameter MSB |
| Program Change | Yes | Yes | Yes | Bank 0: ROM, Bank 1: USER (Range 1-100) |
| System Exclusive | Yes | Yes | Yes | see SysEx Documentation* |
| System Common | No | No | No | |
| System Real Time | No | No | No | |
| Running Status | Yes | Yes | Yes | (2 s Timeout) |
| MSB: Most significant bit | | | | |
| LSB: Least significant bit | | | | |

Fig. 10.1: MIDI implementation

*) Download at www.behringer.com.

11. WARRANTY

§ 1 WARRANTY CARD/ONLINE REGISTRATION

To be protected by the extended warranty, the buyer must complete and return the enclosed warranty card within 14 days of the date of purchase to BEHRINGER Spezielle Studioteknik GmbH, in accordance with the conditions stipulated in § 3. Failure to return the card in due time (date as per postmark) will void any extended warranty claims. Based on the conditions herein, the buyer may also choose to use the online registration option via the Internet (www.behringer.com or www.behringer.de).

§ 2 WARRANTY

1. BEHRINGER (BEHRINGER Spezielle Studioteknik GmbH including all BEHRINGER subsidiaries listed on the enclosed page, except BEHRINGER Japan) warrants the mechanical and electronic components of this product to be free of defects in material and workmanship for a period of one (1) year* from the original date of purchase, in accordance with the warranty regulations described below. If the product shows any defects within the specified warranty period that are not excluded from this warranty as described under § 4, BEHRINGER shall, at its discretion, either replace or repair the product using suitable new or reconditioned parts. In the case that other parts are used which constitute an improvement, BEHRINGER may, at its discretion, charge the customer for the additional cost of these parts.

2. If the warranty claim proves to be justified, the product will be returned to the user freight prepaid.

3. Warranty claims other than those indicated above are expressly excluded.

§ 3 RETURN AUTHORIZATION NUMBER

1. To obtain warranty service, the buyer (or his authorized dealer) must call BEHRINGER (see enclosed list) during normal business hours **BEFORE** returning the product. All inquiries must be accompanied by a description of the problem. BEHRINGER will then issue a return authorization number.

2. Subsequently, the product must be returned in its original shipping carton, together with the return authorization number to the address indicated by BEHRINGER.

3. Shipments without freight prepaid will not be accepted.

§ 4 WARRANTY REGULATIONS

1. Warranty services will be furnished only if the product is accompanied by a copy of the original retail dealer's invoice. Any product deemed eligible for repair or replacement under the terms of this warranty will be repaired or replaced.

2. If the product needs to be modified or adapted in order to comply with applicable technical or safety standards on a national or local level, in any country which is not the country for which the product was originally developed and manufactured, this modification/adaptation shall not be considered a defect in materials or workmanship. The warranty does not cover any such modification/adaptation, irrespective of whether it was carried out properly or not. Under the terms of this warranty, BEHRINGER shall not be held responsible for any cost resulting from such a modification/adaptation.

3. Free inspections and maintenance/repair work are expressly excluded from this warranty, in particular, if caused by improper handling of the product by the user. This also applies to defects caused by normal wear and tear, in particular, of faders, crossfaders, potentiometers, keys/buttons, tubes and similar parts.

4. Damages/defects caused by the following conditions are not covered by this warranty:

- ▲ improper handling, neglect or failure to operate the unit in compliance with the instructions given in BEHRINGER user or service manuals.
- ▲ connection or operation of the unit in any way that does not comply with the technical or safety regulations applicable in the country where the product is used.
- ▲ damages/defects caused by force majeure or any other condition that is beyond the control of BEHRINGER.

5. Any repair or opening of the unit carried out by unauthorized personnel (user included) will void the warranty.

6. If an inspection of the product by BEHRINGER shows that the defect in question is not covered by the warranty, the inspection costs are payable by the customer.

7. Products which do not meet the terms of this warranty will be repaired exclusively at the buyer's expense. BEHRINGER will inform the buyer of any such circumstance. If the buyer fails to submit a written repair order within 6 weeks after notification, BEHRINGER will return the unit C.O.D. with a separate invoice for freight and packing. Such costs will also be invoiced separately when the buyer has sent in a written repair order.

§ 5 WARRANTY TRANSFERABILITY

This warranty is extended exclusively to the original buyer (customer of retail dealer) and is not transferable to anyone who may subsequently purchase this product. No other person (retail dealer, etc.) shall be entitled to give any warranty promise on behalf of BEHRINGER.

§ 6 CLAIM FOR DAMAGES

Failure of BEHRINGER to provide proper warranty service shall not entitle the buyer to claim (consequential) damages. In no event shall the liability of BEHRINGER exceed the invoiced value of the product.

§ 7 OTHER WARRANTY RIGHTS AND NATIONAL LAW

1. This warranty does not exclude or limit the buyer's statutory rights provided by national law, in particular, any such rights against the seller that arise from a legally effective purchase contract.

2. The warranty regulations mentioned herein are applicable unless they constitute an infringement of national warranty law.

* Customers in the European Union please contact BEHRINGER Germany Support for further details.

Technical specifications and appearance subject to change without notice. The information contained herein is correct at the time of printing. SHARC® as well as the names of companies, institutions or publications pictured or mentioned and their respective logos are registered trademarks of their respective owners. Their use neither constitutes a claim of the trademarks by BEHRINGER® nor affiliation of the trademark owners with BEHRINGER®. BEHRINGER® accepts no liability for any loss which may be suffered by any person who relies either wholly or in part upon any description, photograph or statement contained herein. Colors and specifications depicted may vary slightly from product. No part of this book may be reproduced or transmitted in any form or by any means, electronic or mechanical, including photocopying and recording of any kind, for any purpose, without the express written permission of BEHRINGER Spezielle Studioteknik GmbH. BEHRINGER® is a registered trademark.

ALL RIGHTS RESERVED.

© 2003 BEHRINGER Spezielle Studioteknik GmbH.
BEHRINGER Spezielle Studioteknik GmbH, Hanns-Martin-Schleyer-Str. 36-38,
47877 Willich-Münchheide II, Germany
Tel. +49 2154 9206 0, Fax +49 2154 9206 4903