

## MODEL D

Legendary Analog Synthesizer with 3 VCOs, Classic Ladder Filter, LFO, 16-Voice Poly Chain and Eurorack Format

# Table of Contents

<b>Thank you .....</b>	<b>2</b>
<b>Important Safety Instructions .....</b>	<b>3</b>
<b>Legal Disclaimer .....</b>	<b>3</b>
<b>Limited warranty.....</b>	<b>3</b>
<b>About the MODEL D .....</b>	<b>4</b>
<b>1. Introduction .....</b>	<b>5</b>
<b>2. Features.....</b>	<b>5</b>
<b>3. Controls .....</b>	<b>7</b>
<b>4. Overview .....</b>	<b>12</b>
<b>5. Calibration.....</b>	<b>14</b>
<b>6. Hook-up examples .....</b>	<b>26</b>
<b>7. System Exclusive Commands.....</b>	<b>30</b>
<b>8. Eurorack Installation.....</b>	<b>32</b>
<b>9. Specifications.....</b>	<b>34</b>
<b>10. Glossary.....</b>	<b>36</b>

## Thank you

Thank you very much for expressing your confidence in BEHRINGER products by purchasing the MODEL D analog synthesizer - with 3 VCOs, Classic Ladder Filter, LFO, 16-Voice Poly Chain and Eurorack Format

## EN Important Safety Instructions



Terminals marked with this symbol carry electrical current of sufficient magnitude to constitute risk of electric shock.

Use only high-quality professional speaker cables with ¼" TS or twist-locking plugs pre-installed. All other installation or modification should be performed only by qualified personnel.



This symbol, wherever it appears, alerts you to the presence of uninsulated dangerous voltage inside the enclosure - voltage that may be sufficient to constitute a risk of shock.



This symbol, wherever it appears, alerts you to important operating and maintenance instructions in the accompanying literature. Please read the manual.



### Caution

To reduce the risk of electric shock, do not remove the top cover (or the rear section). No user serviceable parts inside. Refer servicing to qualified personnel.



### Caution

To reduce the risk of fire or electric shock, do not expose this appliance to rain and moisture. The apparatus shall not be exposed to dripping or splashing liquids and no objects filled with liquids, such as vases, shall be placed on the apparatus.



### Caution

These service instructions are for use by qualified service personnel only. To reduce the risk of electric shock do not perform any servicing other than that contained in the operation instructions. Repairs have to be performed by qualified service personnel.

1. Read these instructions.
2. Keep these instructions.
3. Heed all warnings.
4. Follow all instructions.
5. Do not use this apparatus near water.
6. Clean only with dry cloth.
7. Do not block any ventilation openings. Install in accordance with the manufacturer's instructions.
8. Do not install near any heat sources such as radiators, heat registers, stoves, or other apparatus (including amplifiers) that produce heat.

9. Do not defeat the safety purpose of the polarized or grounding-type plug. A polarized plug has two blades with one wider than the other. A grounding-type plug has two blades and a third grounding prong. The wide blade or the third prong are provided for your safety. If the provided plug does not fit into your outlet, consult an electrician for replacement of the obsolete outlet.

10. Protect the power cord from being walked on or pinched particularly at plugs, convenience receptacles, and the point where they exit from the apparatus.

11. Use only attachments/accessories specified by the manufacturer.



12. Use only with the cart, stand, tripod, bracket, or table specified by the manufacturer, or sold with the apparatus. When a cart is used, use caution when moving the cart/apparatus combination to avoid

injury from tip-over.

13. Unplug this apparatus during lightning storms or when unused for long periods of time.

14. Refer all servicing to qualified service personnel. Servicing is required when the apparatus has been damaged in any way, such as power supply cord or plug is damaged, liquid has been spilled or objects have fallen into the apparatus, the apparatus has been exposed to rain or moisture, does not operate normally, or has been dropped.

15. The apparatus shall be connected to a MAINS socket outlet with a protective earthing connection.

16. Where the MAINS plug or an appliance coupler is used as the disconnect device, the disconnect device shall remain readily operable.



17. Correct disposal of this product: This symbol indicates that this product must not be disposed of with household waste, according to the WEEE Directive (2012/19/EU) and your national law. This product

should be taken to a collection center licensed for the recycling of waste electrical and electronic equipment (EEE). The mishandling of this type of waste could have a possible negative impact on the environment and human health due to potentially hazardous substances that are generally associated with EEE. At the same time, your cooperation in the correct disposal of this product will contribute to the efficient use of natural resources. For more information about where you can take your waste equipment for recycling, please contact your local city office, or your household waste collection service.

18. Do not install in a confined space, such as a book case or similar unit.

19. Do not place naked flame sources, such as lighted candles, on the apparatus.

20. Please keep the environmental aspects of battery disposal in mind. Batteries must be disposed-of at a battery collection point.

21. Use this apparatus in tropical and/or moderate climates.

## LEGAL DISCLAIMER

MUSIC Tribe accepts no liability for any loss which may be suffered by any person who relies either wholly or in part upon any description, photograph, or statement contained herein. Technical specifications, appearances and other information are subject to change without notice. All trademarks are the property of their respective owners. MIDAS, KLARK TEKNIK, LAB GRUPPEN, LAKE, TANNOY, TURBOSOUND, TC ELECTRONIC, TC HELICON, BEHRINGER, BUGERA and COOLAUDIO are trademarks or registered trademarks of MUSIC Group IP Ltd. © MUSIC Group IP Ltd. 2018 All rights reserved.

## LIMITED WARRANTY

For the applicable warranty terms and conditions and additional information regarding MUSIC Tribe's Limited Warranty, please see complete details online at [music-group.com/warranty](http://music-group.com/warranty).

## About the MODEL D

- Legendary analog synthesizer with triple VCO design allows for insanely fat music creation
- Authentic reproduction of original “D Type” circuitry with matched transistors and JFETs
- Ultra-high precision 0.1% Thin Film resistors and Polyphenylene Sulphide capacitors
- Pure analog signal path based on authentic VCO, VCF and VCA designs
- 5 variable oscillator shapes with variable pulse widths for ultimate sounds
- Classic 24 dB ladder filter with resonance for legendary sound performance
- Switchable low/high pass filter mode for enhanced sound creation
- Dedicated and fully analog triangle/square wave LFO
- 16-voice Poly Chain allows combining multiple synthesizers for up to 16 voice polyphony
- Semi-modular design requires no patching for immediate performance
- Overdrive circuit adds insane spice and edge to your sounds
- Noise generator dramatically expands waveform generation
- Complete Eurorack solution –main module can be transferred to a standard Eurorack case
- 48 controls give you direct and real-time access to all important parameters
- External audio input for processing external sound sources
- Low and high level outputs featuring highest signal integrity signal stages
- Comprehensive MIDI implementation with MIDI channel and Voice Priority selection
- 3-Year Warranty Program\*
- Designed and engineered in the U.K.

\*Warranty details can be found at [music-group.com](http://music-group.com).

## 1. Introduction

An ultra-affordable homage to an iconic synthesizer, with all the features of the original and then some, the BEHRINGER MODEL D lets you conjure up virtually any monophonic sound imaginable with incredible finesse and ease.

The pure analog signal path is based on authentic VCO, VCF, VCA and ladder filter designs in conjunction with a dedicated and fully analog triangle/ square wave LFO. And when it comes to protection and convenience, the MODEL D can even be mounted in a standard Eurorack, making it ideal for the studio and/or the road. Owning a MODEL D is like having your own personal time machine, enabling you to freely embrace the past – or shape the future!

**Please read the manual carefully and keep it for future reference.**

### 1.1 Before you get started

#### 1.1.1 Shipment

The MODEL D was carefully packed in the factory to guarantee safe transport. Nevertheless, we recommend that you carefully examine the packaging and its contents for any signs of physical damage, which may have occurred during transit.



**If the unit is damaged, please do NOT return it to us, but notify your dealer and the shipping company immediately, otherwise claims for damage or replacement may not be granted.**

#### 1.1.2 Initial operation

Be sure that there is enough space around the unit for cooling purposes and, to avoid over-heating, please do not place the MODEL D on high-temperature devices such as radiators or power amps.



**WARNING: The MODEL D is supplied with a AC power adapter. It meets the required safety standards. Do not use any other power adapter.**



**WARNING: Please make sure that all units have a proper ground connection. For your own safety, never remove or disable the ground conductor from any units or AC power cords in your system.**

### 1.2 The product manual

This product manual is designed to give you both an overview of the MODEL D analog synthesizer, as well as detailed information on each of the controls and parameters. You will find an overview of the physical control elements in the next chapter.

#### 1.3 Preparation



**CAUTION: Remember to turn your monitors / loudspeakers on last when powering up your system, and turn your monitors / loudspeakers off first when powering down your system.**

## 2. Features

### True to the Original

Great care has been taken in designing the MODEL D including the true to the original "D Type" circuitry with its matched transistors and JFETs, ultra-high precision 0.1% thin film resistors and polyphenylene sulphide capacitors. This highly-focused attention to detail is what gives the MODEL D its ultra-flexible sound shaping capability, which covers everything from super-fat bass and lead tones, stunning effects, progressive organ sounds – and all the way out to the otherworldly sounds of your imagination.

### Big, Fat Tones

The inspired synthesizer tracks laid down in the 1970s and '80s are etched in the annals of progressive rock, wave and synth-pop music forever, making them truly classic in every sense of the word. MODEL D's pure analog signal path with legendary VCO, VCF and VCA circuits, lets you recreate all of that magic – or design incredibly fat and original sounds that will make you a legend in your own right!

### VCO Triple Play

MODEL D's 3 highly-flexible Voltage Controlled Oscillators (VCOs) provide an incredible range of 5 waveforms for sculpting the perfect sound. Oscillators 1 and 2 options include: triangular; triangular/saw; saw; square; wide pulse; and narrow pulse, while OSC 3 features: triangular; reverse saw; saw; square; wide pulse; and narrow pulse. Additionally, all 3 VCOs can be adjusted across an extremely-wide, 6-octave range (LO, 32', 16', 8', 4', and 2'). This amazing flexibility gives you all the tools you need to be your creative best.

### 24 dB Ladder Filter and VCA

The very heart of MODEL D's sound is its highly-flexible 24 dB Ladder Filter, which lets you freely experiment with the Cutoff Frequency, Emphasis, and Contour to dial in the perfect sound.

MODEL D's Filter Mode switch can be set to either Lo- or Hi-pass for selecting the range of your choice. You can also adjust the Attack, Decay, and Sustain controls to affect the cutoff frequency with time. The VCA Decay switch lets you set the length of time the note lingers after the key has been released. Additionally, support for filter-keytracking allows you to select how much filtering is applied based on the note being played. And if you want to add modulation, just set the Filter Modulation switch to the On position and use the Controllers Mod Mix knob to make it so. The VCA can even be overloaded via MODEL D's feedback circuit to add insane spice and edge to your sounds – without saying "goodbye" to your precious low-end content.

### Making Waves

You are always in complete control of MODEL D's onboard modulators, which feature: adjustable Tune; Mod Depth; LFO Rate; Glide (portamento); and Mod Mix knobs. A range of switches is provided for selecting between: triangle or square wave oscillation; modulation On or Off; OSC 3 or Filter EG (Filter Envelope); and Noise (Mod SRC) or LFO. The Tune knob is used to adjust the frequency of OSC 1, 2 and 3 (as long as the OSC 3 switch is turned off). The internal Noise generator, which is switchable between either Pink or White noise for dramatically expanded waveform generation, is the default modulation source, unless an external Mod Source is connected at the 3.5 mm input jack. The BEHRINGER MODEL D is the ultimate mono, all-analog synthesizer in its class – especially when it comes to sound quality, versatility and affordability.

### **16-Note Poly Chain Ready**

While it is a monophonic instrument (one note at a time), MODEL D's 16-note Poly Chain function lets you combine multiple synthesizers for up to 16-voice polyphony – plus it provides vastly improved reliability and stability over its 1970s and '80s predecessors.

### **Semi-Modular Design**

Designed around an intuitively-linear workflow, MODEL D benefits greatly from its semi-modular design, which requires no patching for immediate performance. Just connect your favorite keyboard or computer via MIDI over DIN or USB – and start exploring the world of analog music synthesis right out-of-the-box.

### **Eurorack Ready**

Designed to handle the rigors of life on the road or in the studio, your MODEL D can easily be transferred into a standard Eurorack case for the perfect integration into your existing system.

### **Controls and Connectivity**

The MODEL D has 29 knobs and 19 switches, all laid out in a highly-intuitive format that puts the joy back into your music creation.

Input and output connections include: MIDI I/O and Thru over USB/MIDI DIN; modulation and audio inputs; OSC1 frequency control; external control of filter cutoff, resonance and contour; Main Out – and Phones, with its own dedicated Volume control.

### **Unleash Your Imagination**

When it comes to not just pushing envelopes but creating them, MODEL D gives your imagination its voice – and it's so very affordable. When modern performance calls for classic analog sound – it calls for the BEHRINGER MODEL D!

### **You Are Covered**

We always strive to provide the best possible Customer Experience. Our products are made in our own MUSIC Tribe factory using state-of-the-art automation, enhanced production workflows and quality assurance labs with the most sophisticated test equipment available in the world. As a result, we have one of the lowest product failure rates in the industry, and we confidently back it up with a generous Warranty program.

### 3. Controls

#### 3.1 Top Controls

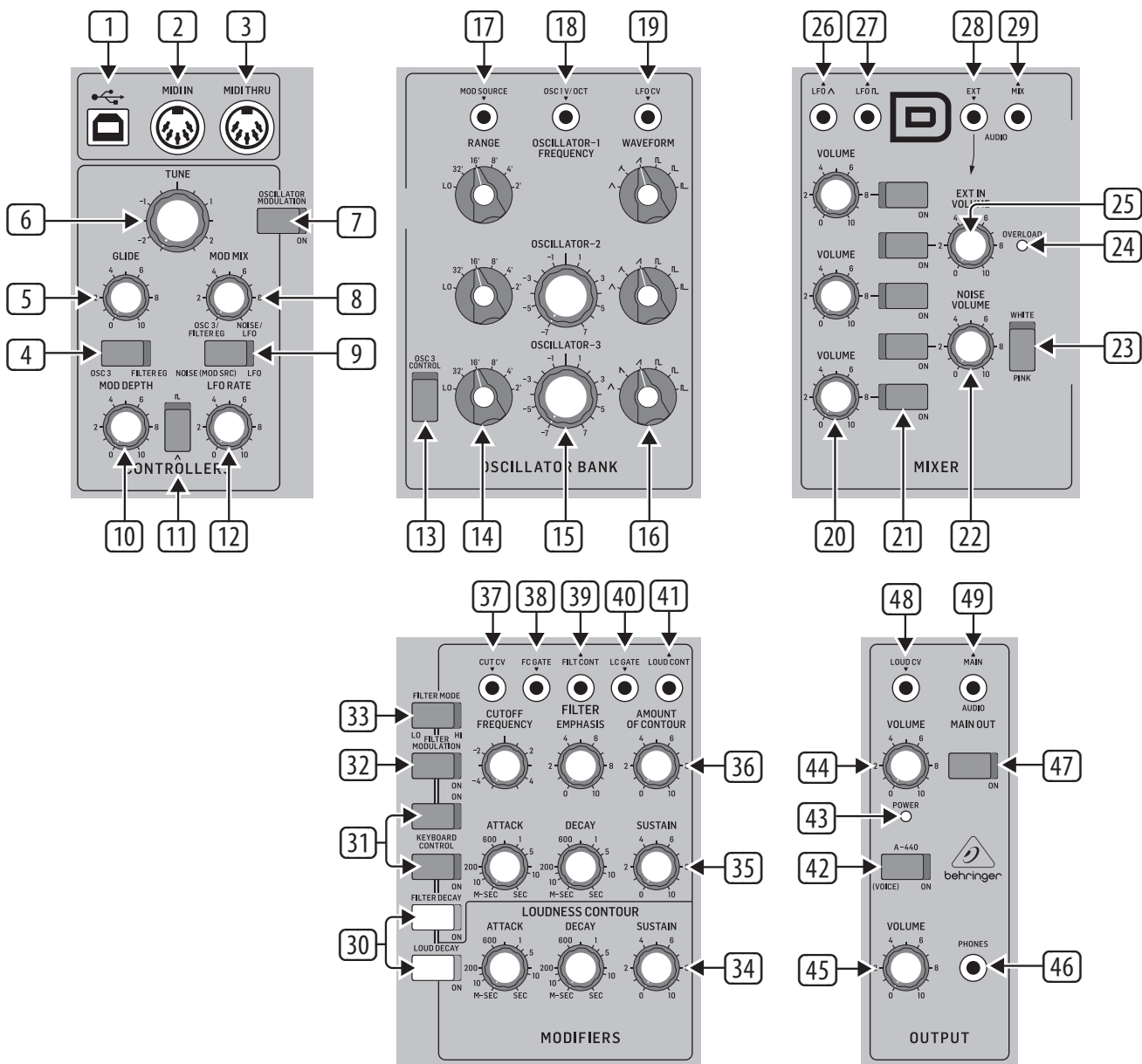
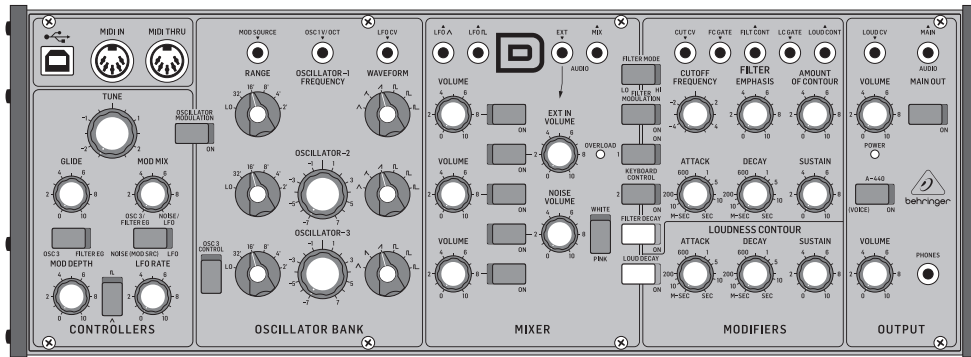

### 3.1.1 MIDI Section

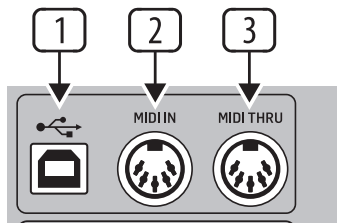

- 1 **USB PORT** - this USB type B jack allows connection to a computer. The MODEL D will show up as a class-compliant USB MIDI device, capable of supporting MIDI in and out.
  - USB MIDI IN** - accepts incoming MIDI data from an application.
  - USB MIDI OUT** - sends MIDI data to an application.
- 2 **MIDI IN** - this 5-pin DIN jack receives MIDI data from an external source. This will commonly be a MIDI keyboard, an external hardware sequencer, a computer equipped with a MIDI interface, etc.
- 3 **MIDI THRU** - this 5-pin DIN jack is used to pass through MIDI data received at the MIDI INPUT. This will commonly be sent to another MODEL D synthesizer to run a Poly Chain or to a drum machine assigned to a different MIDI Channel.

### 3.1.2 Controllers Section

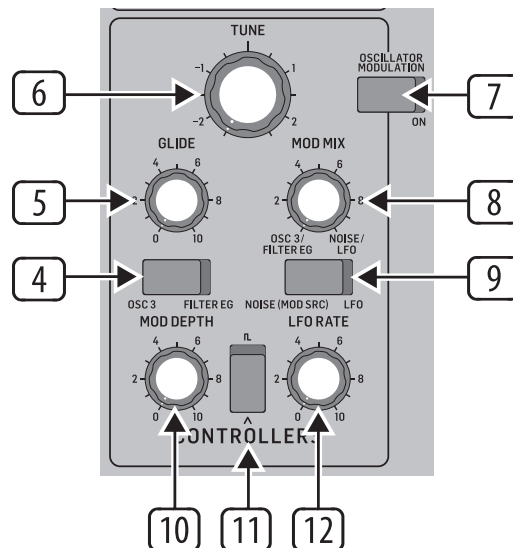

- 4 **OSC3/FILTER EG** - switch between OSC3 or the Filter Envelope as a modulation source.
- 5 **GLIDE** - adjust the amount of Glide (Portamento), between notes on the keyboard.
- 6 **TUNE** - adjust the frequency of oscillators 1, 2, and 3. (OSC3 is not affected if the OSC3 CONTROL switch is off.)
- 7 **OSCILLATOR MODULATION** - when ON, the three oscillators are modulated by the modulation mix, set by the MOD MIX knob.
- 8 **MOD MIX** - adjust the modulation mix between OSC3/Filter EG and Noise/LFO.
- 9 **NOISE (MOD SRC)/LFO** - switch between Noise (or external modulation source) or Low Frequency Oscillator (LFO) as a modulation source.
- 10 **MOD DEPTH** - adjust the modulation depth from off to maximum. The modulation depth can also be adjusted using the modulation wheel on a MIDI keyboard.
- 11 **WAVE SHAPE** - select the LFO wave shape from either triangular or square wave.
- 12 **LFO RATE** - adjusts the frequency of the LFO.



### 3.1.3 Oscillator Bank Section

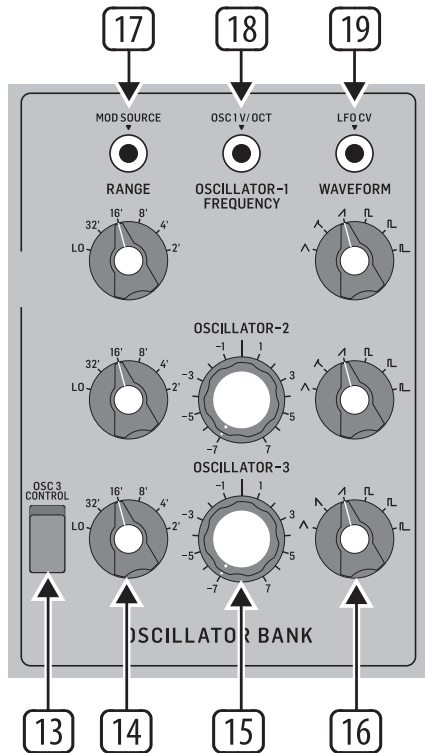

- 13 **OSC 3 CONTROL** - when **ON**, the frequency of OSC 3 will vary with the keyboard. When **OFF**, the keyboard, Pitch wheel, and Modulation wheel, will have no effect on OSC 3.
- 14 **FREQUENCY RANGE** - select from six frequency ranges of Oscillator 1, 2, or 3.
- 15 **FREQUENCY ADJUSTMENT** - adjust the frequency of Oscillator 2 or 3.
- 16 **WAVE SHAPE** - select the wave shape of Oscillator 1, 2, or 3 from: triangular, triangular/ sawtooth (OSC1 and 2), reverse sawtooth (OSC3), sawtooth, square, medium pulse, and narrow pulse.
- 17 **MOD SOURCE (INPUT)** - allows connection of an external modulation source. If nothing is connected here, then the internal Noise generator is available as a modulation source.
- 18 **OSC 1V/OCT (INPUT)** - this input allows the frequency of the three oscillators to be adjusted by an external control voltage (1 Volt input increase, will increase the frequency by one Octave).
- 19 **LFO CV (INPUT)** - allows control of the LFO frequency by an external control voltage.

### 3.1.4 Mixer Section

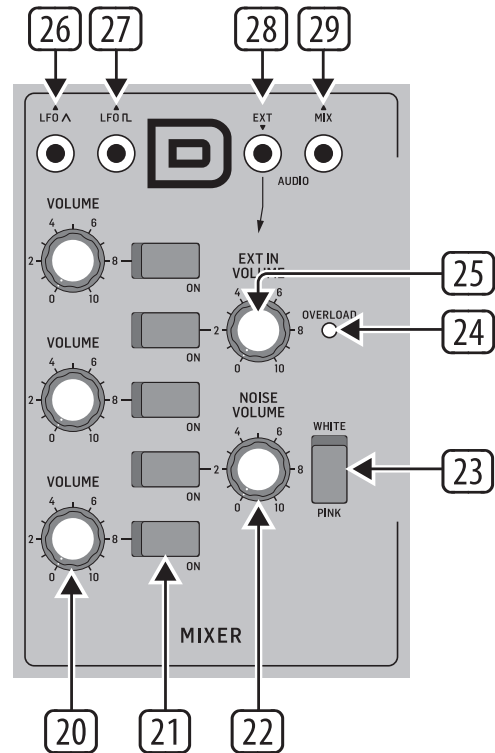

- 20 **VOLUME** - adjust the volume of Oscillator 1, 2, or 3.
- 21 **ON/OFF** - select the sources to play from OSC1, OSC2, OSC3, Noise, and External Input, or any combination of these 5 sources.
- 22 **NOISE VOLUME** - adjust the level of the internal Noise source.
- 23 **WHITE/PINK** - switch the internal Noise source from Pink noise to White noise.
- 24 **OVERLOAD** - indicates when the audio levels of the mix are overloading the mixer section.
- 25 **EXT IN VOLUME** - adjust the level of any external source playing into the External Input. If nothing is connected to the external input, then the main output is connected here and can be adjusted by this volume knob.
- 26 **LFO Triangular (OUTPUT)** - outputs the internal LFO triangular-wave signal.
- 27 **LFO Square (OUTPUT)** - outputs the internal LFO square-wave signal.
- 28 **EXT (INPUT)** - connect any external line-level audio source to this 3.5 mm input. If nothing is connected here, then the main audio output is internally connected to this external input.
- 29 **MIX (OUTPUT)** - outputs the final mix from this Mixer section.

### 3.1.5 Modifiers Section

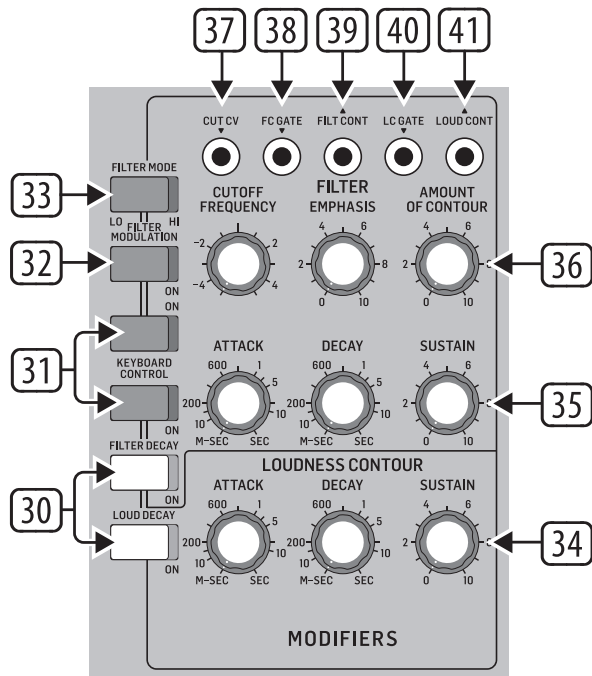

- 30** **DECAY** - when ON, the signal will decay during the time set by the DECAY TIME knob after a note or external trigger is released. When OFF, it will decay immediately after a note or external trigger is released.

**LOUDNESS DECAY** - affects the decay of volume level of the Loudness section.

**FILTER DECAY** - affects the decay of the cutoff frequency of the Filter section.

- 31** **KEYBOARD CONTROL** - these switches vary the effect of the keyboard tracking, where the filter section is affected by the pitch of note played.

**Switch 1 and 2 OFF** - no keyboard tracking effect

**Switch 1 and 2 ON** - maximum effect

**Switch 1 ON (only)** - 1/3 of maximum effect

**Switch 2 ON (only)** - 2/3 of maximum effect

- 32** **FILTER MODULATION** - when ON, the filter section is modulated by the modulation mix, set by the MOD MIX knob.

- 33** **FILTER MODE** - select the filter between Low-Pass or High-Pass.

- 34** **LOUDNESS CONTOUR** - these 3 knobs adjust the overall shape enveloping the audio after it has passed through the mixer section and filter section. The controls affect the change in volume (loudness) level with time.

**ATTACK** - adjust the time it takes for the signal to reach a maximum level after a note is played.

**DECAY TIME** - adjust the time for a signal to decay down to the sustain volume level after the attack time is over. If the LOUDNESS DECAY switch is ON, this is also how long it takes to decay to minimum once a note is released.

**SUSTAIN** - adjust the volume level that the signal is sustained after the attack time and initial decay time have been reached.

- 35** **FILTER ENVELOPE CONTROLS** - these 3 knobs adjust the overall shape enveloping the filter section. The controls affect the change in cutoff frequency with time.

**ATTACK** - adjust the time for the cutoff frequency to increase from its set value and reach the frequency set by the AMOUNT OF CONTOUR control.

**DECAY TIME** - adjust the time for the cutoff frequency to decay down to the sustain frequency after the attack time is over. If the FILTER DECAY switch is ON, then this decay time is also how long it takes to decay from the sustain frequency once a note is released.

**SUSTAIN** - adjust the cutoff to a frequency which is sustained after the attack time and initial decay time have been reached.

- 36** **FILTER CONTROLS** - the filter can be Low-Pass or High-Pass, depending on the setting of the FILTER MODE switch. In Low-Pass mode, audio frequencies above the cutoff frequency are attenuated. In High-Pass mode, audio frequencies below the cutoff frequency are attenuated.

**CUTOFF FREQUENCY** - adjust the cut-off frequency of the filter.

**FILTER EMPHASIS** - adjust the amount of volume level boost (resonance) given at the cut-off frequency.

**AMOUNT OF CONTOUR** - adjust the amount of frequency shift given to the cutoff frequency.

- 37** **CUT CV (INPUT)** - allows connection of a control voltage to control the cutoff frequency.

- 38** **FC GATE (INPUT)** - allows an external trigger voltage to be applied to trigger the filter contour.

- 39** **FILT CONT (OUTPUT)** - outputs the filter contour.

- 40** **LC GATE (INPUT)** - allows an external trigger voltage to be applied to trigger the loudness contour.

- 41** **LOUD CONTOUR (OUTPUT)** - outputs the loudness contour.

### 3.1.6 Output Section

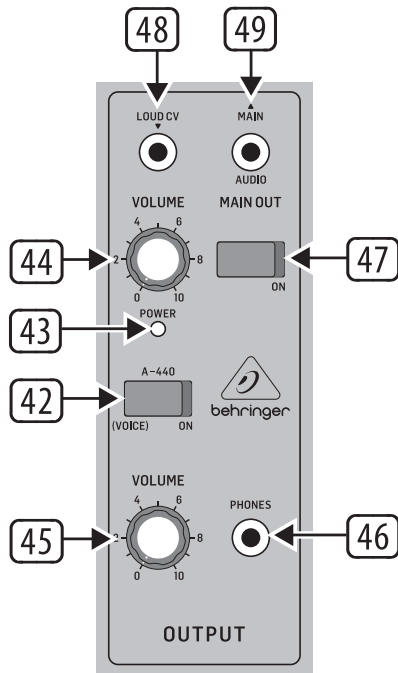

- 42 **A-440** - use this to turn on an output tuning signal of 440 Hz concert pitch. This switch can also be used to enter various modes during turn-on (see the Overview section of this manual for more details).
- 43 **POWER LED** - this LED shows when power is applied and the synthesizer is turned on. It is also used to indicate the current status when changing modes
- 44 **VOLUME** - adjust the overall volume level of the synthesizer output.
- 45 **VOLUME (HEADPHONE)** - adjust the overall volume level of the PHONES output.
- 46 **PHONES** - connect your headphones to this 3.5 mm TRS output. Make sure the headphone volume is turned down before putting on headphones.
- 47 **ON** - use this to quickly turn on or Mute the main audio output of the synthesizer.
- 48 **LOUD CV (INPUT)** - allows connection of an external control voltage to control the Loudness Contour.
- 49 **MAIN (OUTPUT)** - use this 3.5 mm TRS connection to output the main audio output. Typically it is patched to an audio input of the MODEL D or the audio inputs of other modular synthesizer equipment. If you are using the MODEL D in a Eurorack, then this is the main output, as the rear panel output connectors are not used.

### 3.2 Rear Panel

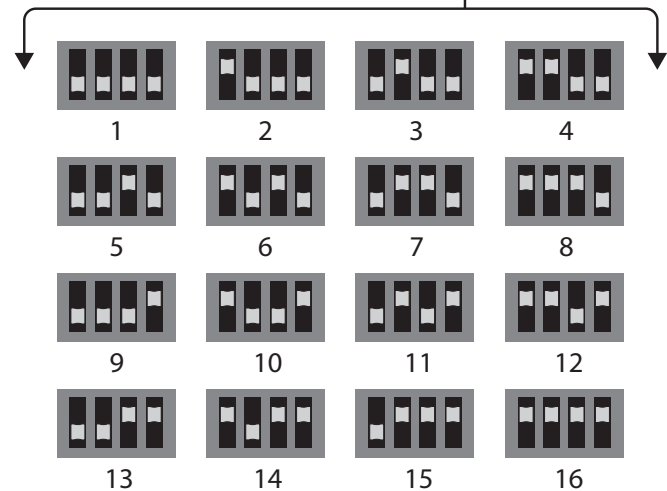
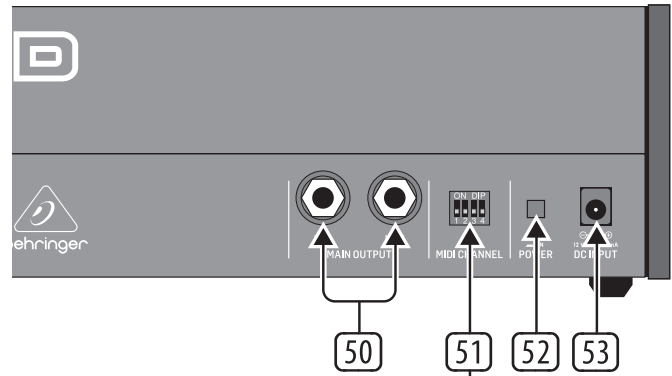

- 50 **MAIN OUTPUT** - connect these 1/4" TRS outputs to the inputs of your external equipment as follows (note that they are both Mono, and not left/right):
  - LOW** - this instrument-level mono output can connect to the instrument-level inputs of guitar amplifiers or mixers for example.
  - HIGH** - this line-level mono output can connect to the line-level inputs of mixers, keyboard amplifiers, or powered speakers for example.
- 51 **MIDI CHANNEL** - these 4 switches allow you to set the MIDI Channel number from 1 to 16 (see the table above). The MIDI channel can also be changed using MIDI SysEX commands, as shown in the MIDI SysEX tables later in this manual.
- 52 **POWER** - turn the synthesizer on or off. Make sure all the connections are made, and the volume is turned down before turning on the unit.
- 53 **DC INPUT** - connect the supplied 12V DC power adapter here. The power adapter can be plugged into an AC outlet capable of supplying from 100V to 240V at 50 Hz/60 Hz. Use only the power adapter supplied.

## 4. Overview

This overview will help you set up the MODEL D analog synthesizer and briefly introduce its capabilities.

### 4.1 Connection

To connect the MODEL D to your system, please consult the hookup examples in this document.

**Caution: Do not overload the 3.5 mm inputs.** They can only accept the correct level of voltages as shown in the specification tables. The 3.5 mm outputs should only be connected to inputs capable of receiving the output voltages. Failure to follow these instructions may damage the MODEL D or external units.

### 4.2 Software Setup

The MODEL D is a USB Class Compliant MIDI device, and so no driver installation is required. The MODEL D does not require any additional drivers to work with Windows and MacOS.

### 4.3 Hardware Setup

Make all the connections in your system. Use the rear panel MIDI switches to set the MODEL D to a unique MIDI channel in your system. Connect the MIDI OUT output of an external MIDI keyboard directly to the MIDI IN 5-pin DIN type input of the MODEL D.

Apply power to the MODEL D using the supplied power adapter only. Ensure your sound system is turned down. Turn on the MODEL D rear panel power switch.

#### 4.3.1 Warm Up Time

We recommend leaving 15 minutes or more time for the MODEL D to warm up before recording or live performance. (Longer if it has been brought in from the cold.) This will allow the precision analog circuits time to reach their normal operating temperature and tuned performance.

#### 4.3.2 Initial Setup

A quick way of finding out if your external sound system is working, is to turn on the A-440 switch on the MODEL D and adjust the volume control. This will send a constant tone (440 Hz) to your external amplifier and speakers.

### 4.4 Mixer Section

The MODEL D has three oscillators, an internal Noise generator, and an external source input. Each of these, and any combination, are used by the MODEL D to generate sound.

The Mixer section allows you to turn each of these sources on or off, and adjust the volume of each to create an overall mix. Start by turning on the top switch for Oscillator 1, and turn off the others. Adjust the volume control of Oscillator 1. In the Output section, adjust the main volume. Now, if you play a note on your MIDI keyboard, you should hear the sound of Oscillator 1 only.

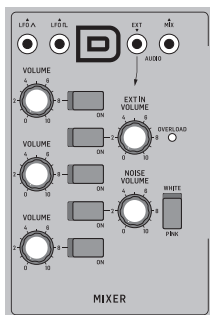

Turn on other oscillators and/or noise and adjust their volume controls to create a mix.

### 4.5 Oscillator Section

In the Oscillator section, adjust the Range knob and you will hear the sound of the various octaves. Adjust the wavetype and listen to the differences.

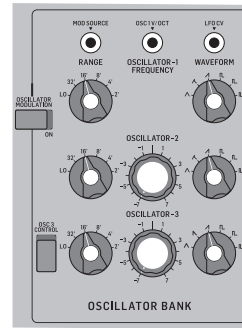

The oscillator modulation switch allows the oscillator frequency to be modulated by the modulation mix.

The OSC 3 switch allows its frequency to be affected by, or be independent of, the notes played on the keyboard, and the modulation and pitch wheels.

**Note:** The TUNE knob and OSCILLATOR-2 and -3 FREQUENCY knobs are marked in units of semitones as a general guide.

### 4.6 Filter Section

Play with the Cutoff Frequency, Emphasis, and Contour, and listen to their effects on the sound. Adjust the Attack, Decay, and Sustain; they affect the cutoff frequency with time, while a note is played.

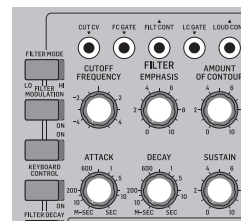

The filter decay switch affects the decay after a note is released. The 2 keyboard switches affect how much the filter is affected by the frequency of notes that are played.

If the filter modulation switch is ON then the filter section is modulated by the modulation mix.

### 4.7 Loudness Contour Section

In this section, adjust the Attack, Decay, and Sustain; they affect the overall level with time, while a note is played. The loudness decay switch affects the decay in level after a note is released.

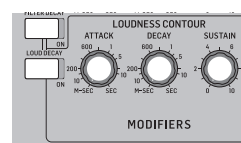

## 4.8 Controllers Section

First set the 2 switches to choose from internal LFO or internal Noise, OSC 3 or the filter envelope, and then use the MOD MIX knob to vary the mix between them.

You can experiment by first setting the left switch to OSC 3, and turning the MOD MIX knob to OSC 3. Then set the Oscillator 3 RANGE control to LO, and the Oscillator Modulation switch ON. You may now be able to hear the sound of the Oscillator 1 modulated by OSC 3. Use the MOD DEPTH knob, and/or the Modulation wheel of your keyboard to increase the effect.

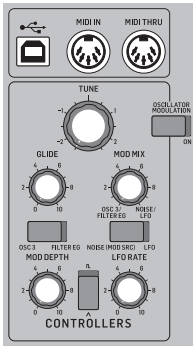

If the Filter Modulation switch is ON, listen to the effect of modulation on the filter.

The Modulation Sensitivity curve can be chosen from hard, medium, or soft (the default), using the SysEx commands shown later in this manual.

## 4.9 Special Modes

The A-440 switch can be used to set the MODEL D into various modes of operation. This is done by turning the A-440 switch on and off a certain number of times within the first 5 seconds of turning on power to the MODEL D. The number of times determines the mode, as shown in the table below. The Power LED will show the current value by flashing fast or slow a number of times, as shown in the table below.

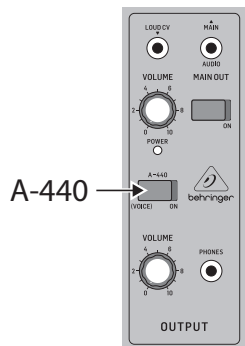

The special modes are: Multi-trigger, Note Priority, and Poly Chain operation.

Press the A-440 switch:	Mode	Power LED Flashing
On and off	Multi-trigger ON	Flashing fast twice
	Multi-trigger OFF	Flashing slow twice
On and off and on	Note Priority LAST/LOW/HIGH	Flashing 3 times
On and off, On and off	Poly Chain ON	Flashing fast four times
	Poly Chain OFF	Flashing slow four times

### 4.9.1 Multi-Triggering

**Multi-triggering - On:** playing a new note will change the pitch and also trigger the filter and loudness contour envelopes.

**Multi-triggering - Off (default, Legato):** playing a new note will change the pitch, but with no new triggering unless all notes are released. For example, you can play a note and hold it down, and any new note will play and use the envelopes of the note being held. The second note will often play after the attack and decay time of the held note has passed, so the second note will not have the sound that the attack and decay usually give.

### 4.9.2 Note Priority

**Note Priority** - if more than one note is played at the same time, this sets which note has priority: the last note played, the lowest (default), or the highest.

### 4.9.3 Poly Chain

**Poly Chain** - if you have multiple MODEL D units, you can connect them in a Poly Chain so that the first MODEL D plays the lowest note, the second MODEL D plays the second lowest note, and so on, to produce polyphonic sound.

Each MODEL D must have the same MIDI channel number set using the rear panel switches. The Poly Chain connections are shown in the diagram in the hookup diagrams of this manual.

Only set the Poly Chain ON for the first MODEL D. Turn it OFF if you no longer require a Poly Chain system.

If you are only using one MODEL D, then make sure the Poly Chain is OFF.

## 4.10 Eurorack

The MODEL D synthesizer can be taken out of its factory chassis and fitted into a standard Eurorack case (not supplied). Please see the details shown later in this manual.

## 4.11 Firmware Update

Please check our website [behringer.com](http://behringer.com) regularly for any updates to the firmware of your MODEL D synthesizer. The firmware file can be downloaded and stored on your computer, and then used to update the MODEL D. It comes with detailed instructions on the update procedure.

## 4.12 Have Fun

The MODEL D has various Gate and CV inputs and outputs that allow for further experimentation and expansion to other MODEL D units and modular synthesizer equipment.

The SysEx features of the MODEL D allow you to set and adjust various parameters to suit your preferences. Please see the SysEx information later in this manual.

Make copies of the patch sheet in this manual, and record your favorite settings.

With all these controls, the possibilities for musical creativity are endless, rather like an artist with a new box of paints. We hope that you will enjoy your new MODEL D.

## EN 5. Calibration

The MODEL D synthesizer can be calibrated and checked occasionally to ensure that it is operating at peak performance. Analog circuitry can drift off with time and temperature, and as components age.

The main printed circuit board (PCB) of the MODEL D has various test points and miniature potentiometers (trimpots) that allow the various calibration and adjustment procedures to be carried out. This involves lifting up the front panel to allow access to the bottom side of the PCB.

Three main calibrations can be carried out:

1. The PITCH CV can be calibrated using a computer to send a SysEx command, an external keyboard, and a digital DC voltmeter. See section 5.2
2. The oscillators can be calibrated using the internally-generated A-440 concert pitch, and an external keyboard. See section 5.3
3. The Octave RANGE can be calibrated using an external keyboard. See section 5.4



We recommend that the following procedures are undertaken only by an experienced service technician, to prevent personal injury, or damage to the unit.

As the internal PCB trimpots are delicate, make sure the procedures are not undertaken too many times. Damage to the trimpots is not covered under warranty, so please take every care when adjusting them.

### A-440 Reference

The MODEL D A-440 pitch is generated and regulated by the MCU and there is no adjustment required. This set frequency is used as a reference in the following procedure to calibrate OSC1.

### Equipment required

- Small insulated trimpot screwdriver
- Small Phillips screwdriver
- A flat sheet of cardboard or other insulator as wide as the MODEL D. (This will help prevent damage to the top panel when it is inverted and resting on the bottom chassis)

### The following equipment is required for the Oscillator adjustment and Octave Range adjustment:

- An external MIDI keyboard of at least 3 octaves including A2 and C6
- MIDI cable
- Pair of headphones or a sound system to monitor the main output

### The following equipment for the Pitch CV adjustment:

- Digital DC Voltmeter with a scale that can display accurately to 0.001 V
- Laptop or desktop computer previously loaded with and running a MIDI utility that can send SysEx commands to the MODEL D
- USB type A to USB type B connection cable

### Important Note about Reset

If you have previously adjusted the MIDI IN Transpose or MIDI Note Zero Volts, you MUST reset the MODEL D to its factory settings before doing the following procedures. The details of using SysEx to send the Reset command are shown on page 30.

## Preparations

Before doing the PITCH CV calibrations, become familiar with, and practice the procedures for sending SysEx commands to the MODEL D. In this way, you will spend less time with the calibrations.

## 5.1 Preliminary Procedure

Follow all steps in the order in which they are presented.

The diagram below shows the typical connections for this procedure.

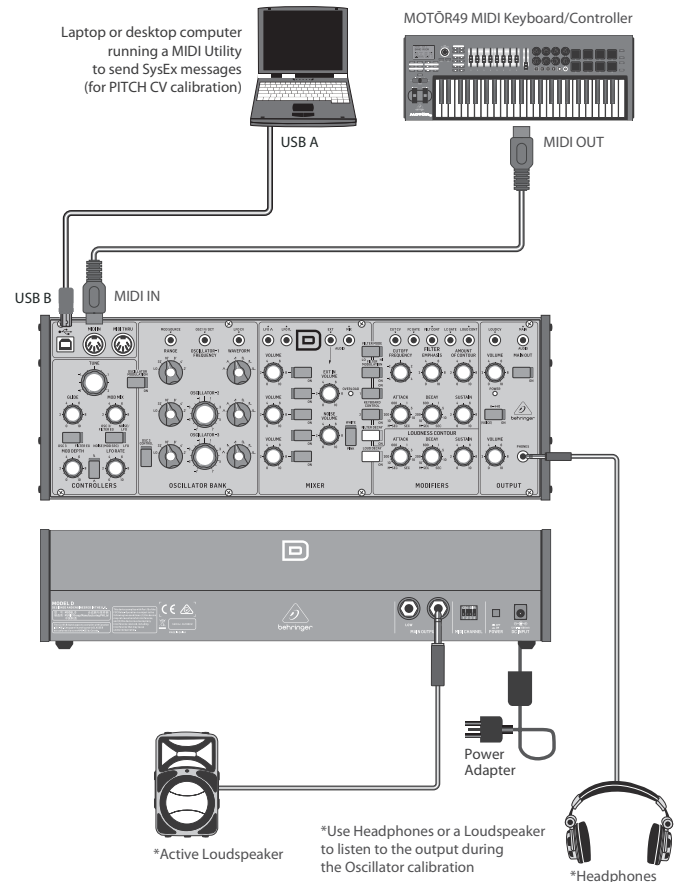

### 5.1.1 Connections

1. Connect the external power supply adapter to the rear power input of the MODEL D.
2. Connect the MIDI output of an external keyboard to the MIDI IN connector of the MODEL D.
3. Connect a laptop or desktop computer to the MODEL D USB input. (This is only required if you are doing the PITCH CV calibration, or doing a Reset.)
4. Turn down the MODEL D headphone volume knob, and connect your headphones to the MODEL D headphones output connector. Alternatively, you can monitor the MODEL D output using the main outputs and a suitable sound system and speakers.
5. Turn on the MODEL D rear panel power switch and check that its Power LED comes on.
6. **Important:** Leave the MODEL D turned on for approximately 30 minutes. This will allow the circuits time to warm up and the components and performance to stabilise with temperature. Without this warm-up time, the calibrations will be inaccurate.
7. Set the MODEL D controls as shown on the next page.

continued on page 16



### 5.1.2 Lifting off the top panel

8. Turn off the MODEL D power.
9. Try and do the following steps quickly and carefully to keep any cooling down to a minimum.
10. Carefully undo the 8 screws on the top panel as shown. There is no need to undo any other screws.

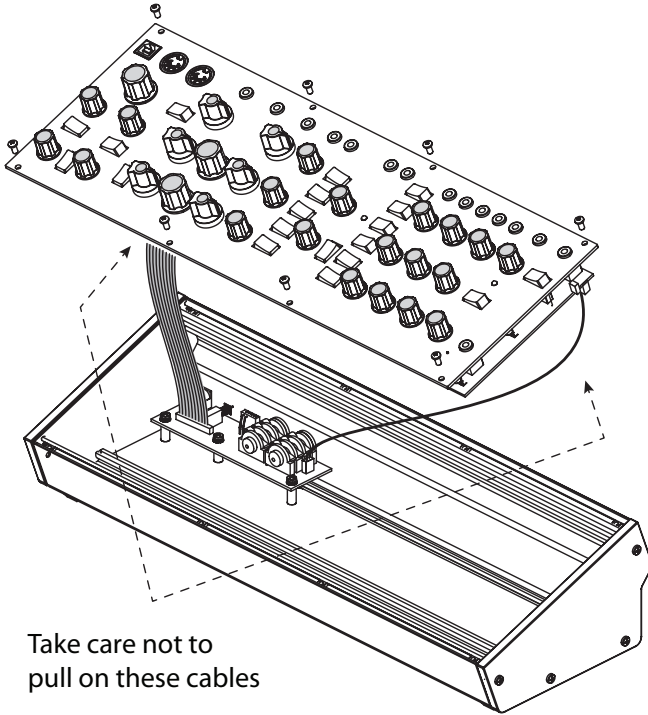

11. Carefully lift the top panel assembly and turn it over so the PCB is facing upwards. Be careful not to pull on the two cables from the lower side of the main PCB. As your connections to other equipment are still in place, take care not to pull out any cables or damage them.
12. Place a piece of cardboard or similar insulator between the controls and the main chassis. This will help prevent damage to the controls as you lay the top assembly onto the main chassis.
13. Make sure that the top panel is in a secure position and that it is not liable to be dropped or damaged, or become disconnected with its internal cables or the MIDI cables or headphone cable.
14. Double check that the MODEL D controls are still as shown on the previous page, in case they were moved during the top panel removal.
15. Because the main PCB is exposed, make sure you are not touching it, and that it is not touching any metal work that may cause a short-circuit.
16. Turn on the MODEL D rear panel power switch and check that its Power LED comes on.
17. Do not turn off the MODEL D or let it cool down, until all the calibrations are completed.
18. If the A-440 switch is in the ON position, you should hear the tone in your headphones or main system if you carefully bring the headphone volume or main volume up.
19. Now that everything is ready, inspect the bottom surface of the PCB as shown on the next page.



The diagram below shows the Test Points TP1 and TP2 used in the PITCH/CV calibration. Take a look at the PCB and locate these two test points.

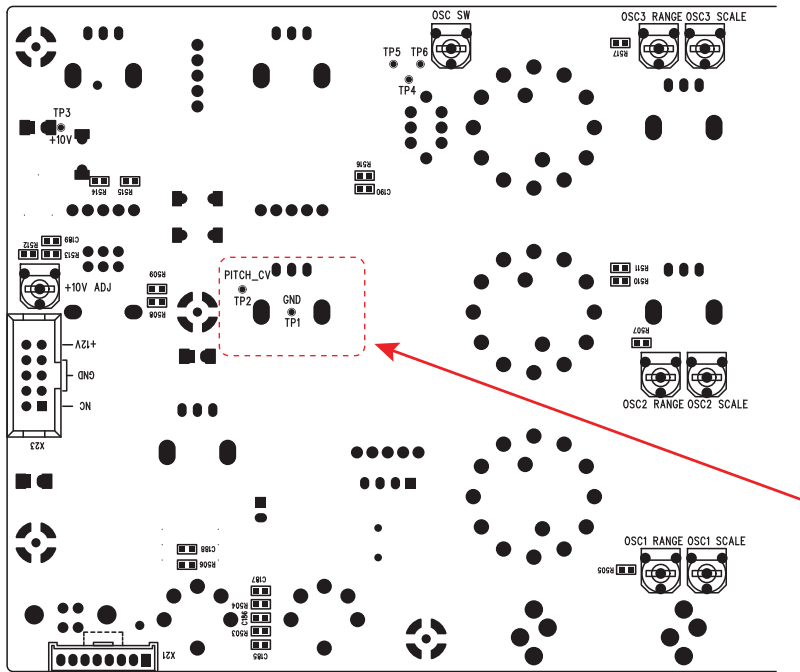

The diagram below shows the adjustment trimpots that are used in the Oscillator and Octave range calibration procedures. Take a look at your PCB and locate these various trimpots.

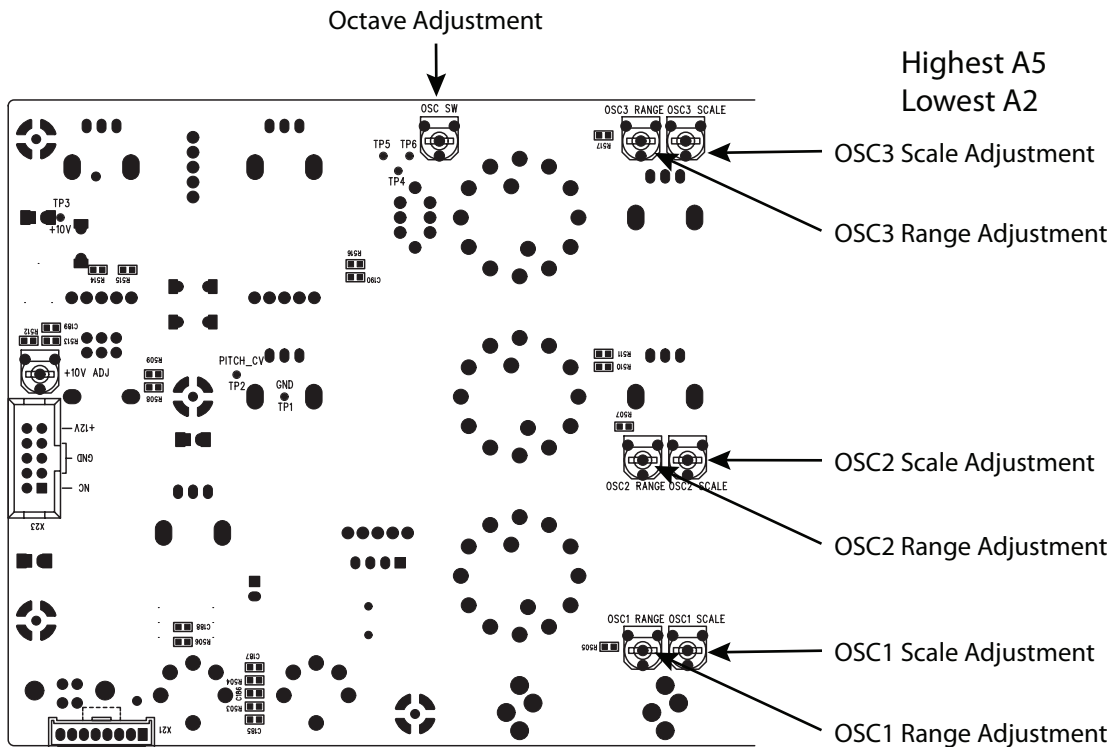

## 5.2 PITCH CV Calibration

The PITCH CV calibration procedure uses a computer MIDI utility to send a SysEx command to the MODEL D to put it into calibration mode.

Once in calibration mode, a digital DC Voltmeter is used to measure the voltage at a test point while test notes are played using the external keyboard.

The meter should have a resolution of 3 or more decimal places, for example 0.001 V.

### 5.2.1 Putting the MODEL D into Pitch CV Calibration Mode

The following example shows the use of the popular MIDI Utility "MIDI OX" to send a SysEx message from your computer to the MODEL D to put it into PITCH CV Calibration mode. (This same procedure can be used to send any SysEx message to the MODEL D.)

1. Run MIDI OX on your computer, and go to OPTIONS/MIDI DEVICES.

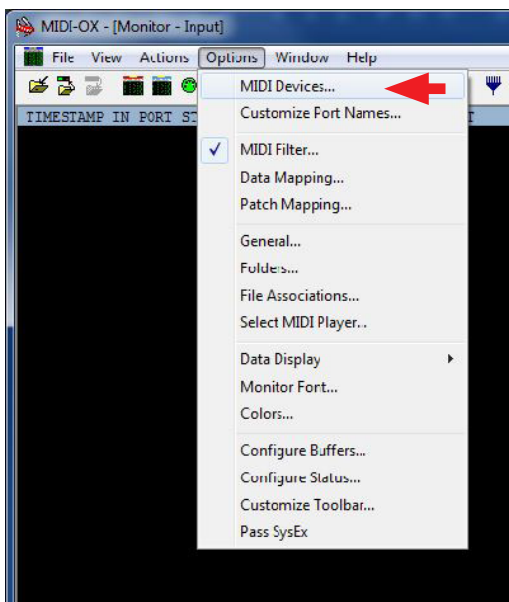

2. Select the MODEL D as the MIDI IN and MIDI OUT.

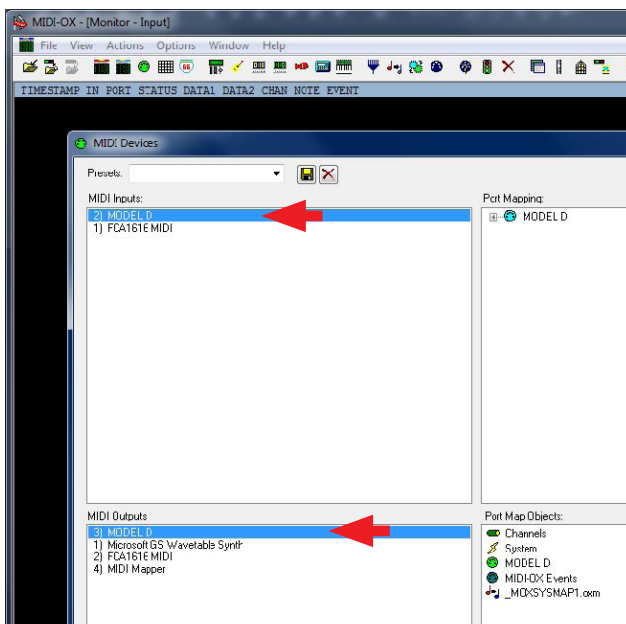

3. Select "Pass SysEx" at the bottom of the Options pull down menu. (It might already be ticked, which is fine.)

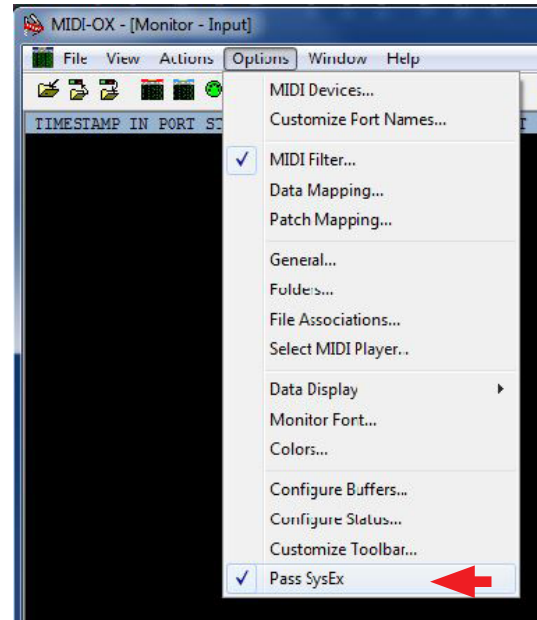

4. In the VIEW Menu, select SysEx..

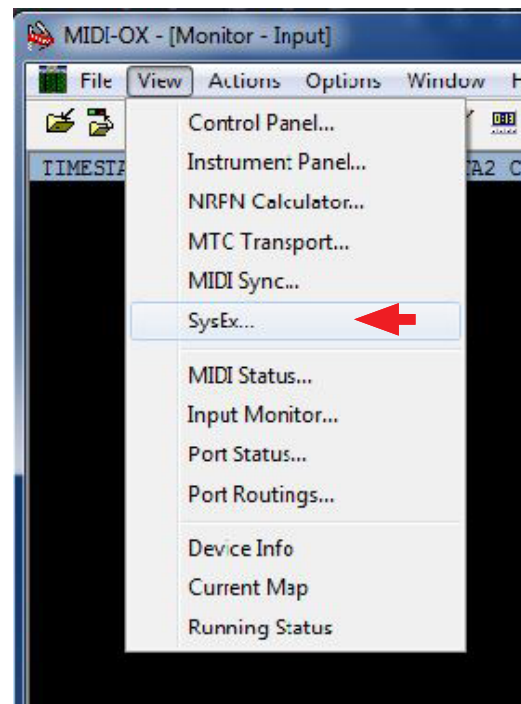

- In the Command Window, enter the SysEx command to be sent to the MODEL D. For PITCH Calibration, the command is:

**F0 00 20 32 00 7F 0E 00 00 00 F7**

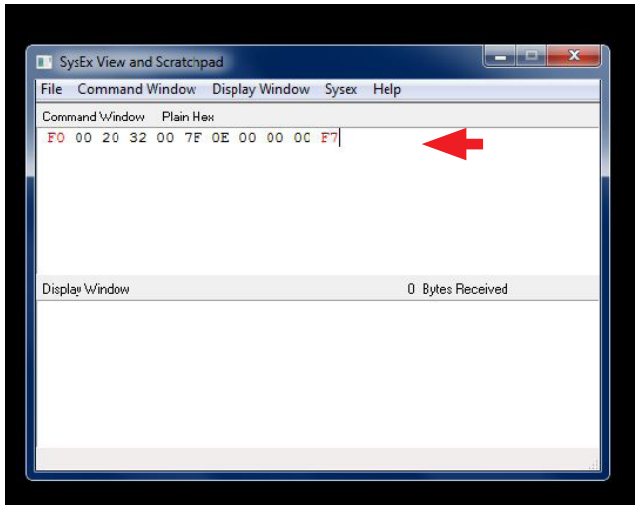

- In the Command Window drop-down menu, select Send SysEx.

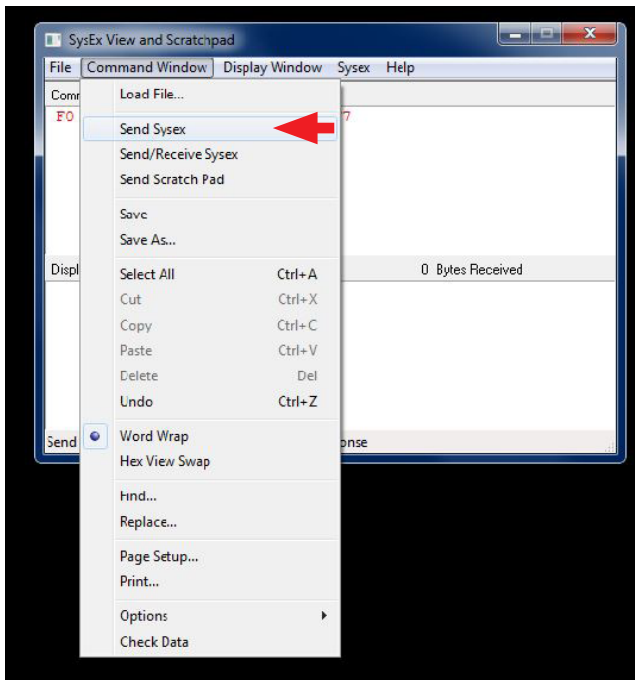

- The SysEx message will be sent to the MODEL D, and it will then be in its PITCH Calibration mode.

- If you wanted, you can use the SAVE AS command in the Command Window drop down menu to save the SysEx message as a file on your computer for later use.

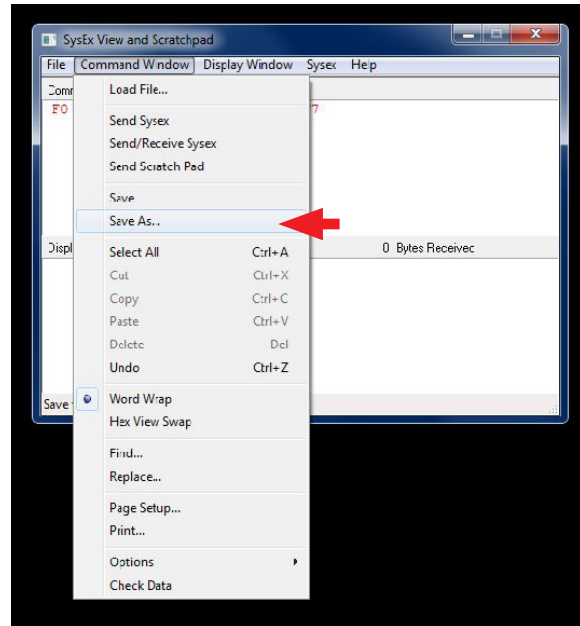

- Then use the LOAD command in the Command Window drop down menu to recall the SysEx message from a file on your computer.

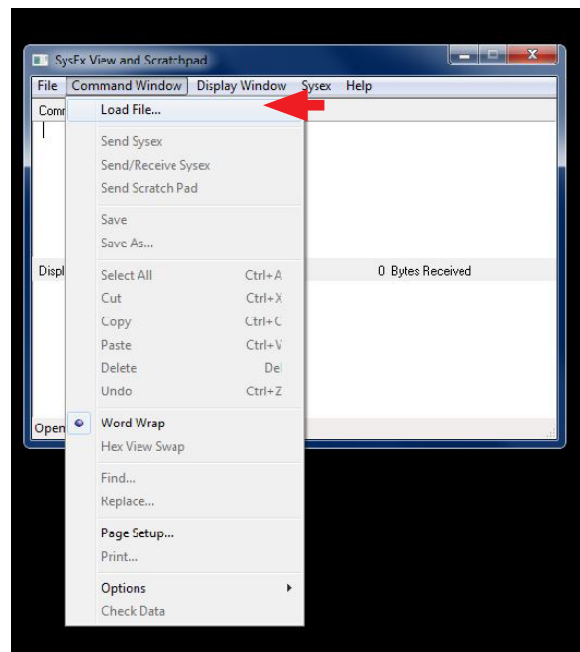

## Pitch CV Calibration continued

### 5.2.2 Procedure

1. Follow the procedure on the previous page to put the MODEL D into PITCH Calibration mode using SysEx.
2. Make sure that the preliminary procedures shown in section 5.1 have been followed, and the MODEL D front panel controls and switches are set as directed.
3. Set the Digital Voltmeter to measure a range below 10 VDC.
4. Locate the Test Points PITCH CV TP1 and TP2 on the bottom surface of the main PCB, as shown below.
5. Connect the positive probe of your Voltmeter to TP2.
6. Connect the negative probe of your Voltmeter to TP1 (ground).

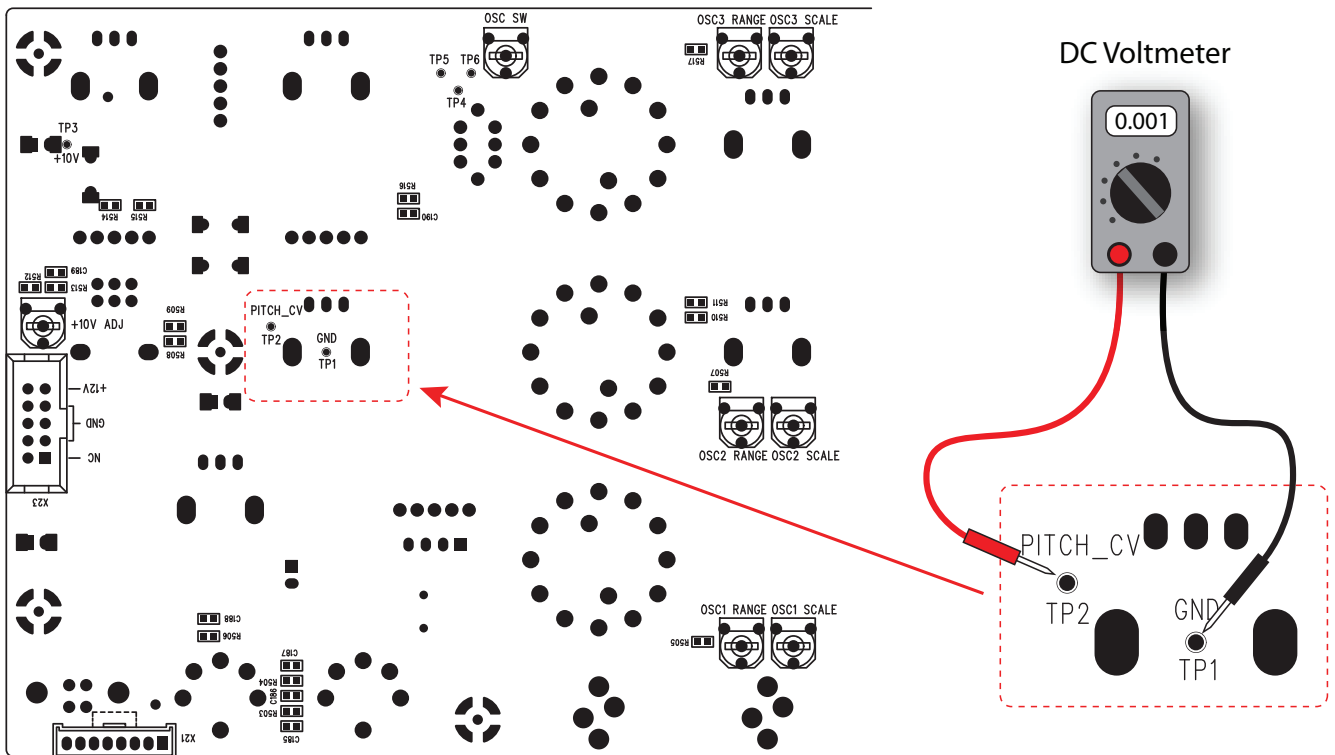

7. The keyboard diagram on the next page shows the keys used during the PITCH CV calibration procedure. The calibration requires setting three values: Low, Zero, and High. Various keys on the external keyboard are used to select and trigger these three different calibrations, to adjust the voltage readings, and to **Save** and **Exit** the procedure..

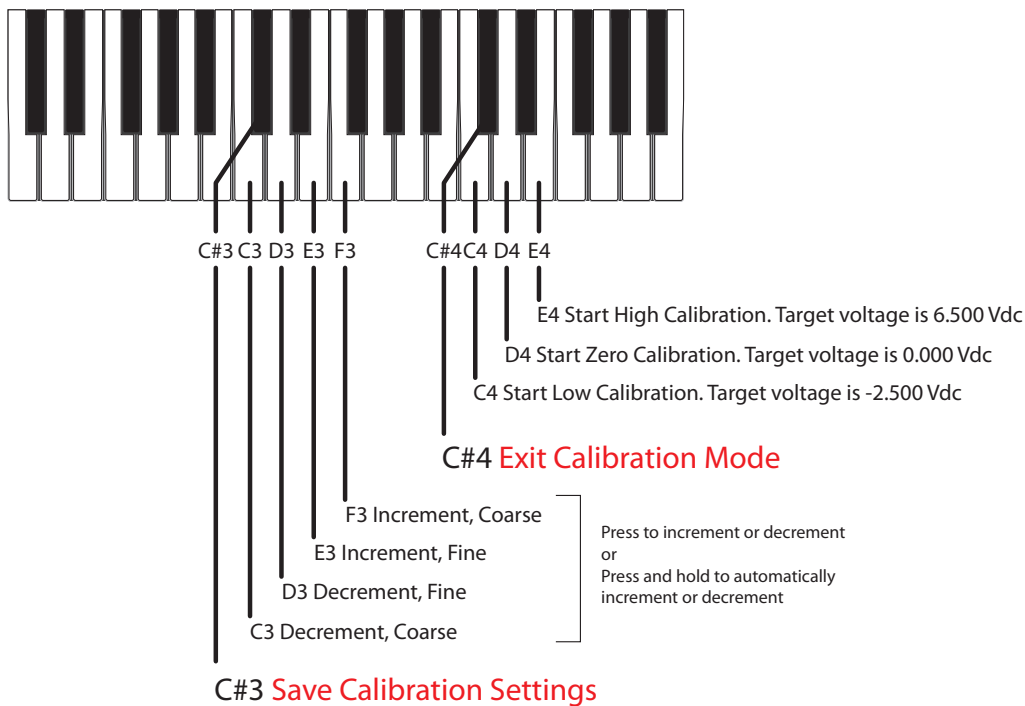

### Low Calibration Adjustment

8. Press C4 on the external keyboard to set the Low calibration value.
9. Measure the output voltage. It should read **-2.500 VDC**.
10. If required, the output voltage can be adjusted to this value by pressing the following keys. The Pitch/CV output adjustment resolution is about 2 mV
  - C3 = decrement coarse
  - D3 = decrement fine
  - E3 = increment fine
  - F3 = increment coarse

TIP: You can press and hold an increment or decrement key and (after a brief delay) the output adjustment will repeat automatically until the key is released.

### Zero Calibration Adjustment

11. Press D4 on the external keyboard to set the Zero calibration value.
12. Measure the output voltage. It should read **0.000 VDC**.
13. If required, the output voltage can be adjusted to this value by pressing the following keys. The Pitch/CV output adjustment resolution is about 2 mV
  - C3 = decrement coarse
  - D3 = decrement fine
  - E3 = increment fine
  - F3 = increment coarse

### High Calibration Adjustment

14. Press E4 on the external keyboard to set the High calibration value.
15. Measure the output voltage. It should read **+6.500 VDC**.
16. If required, the output voltage can be adjusted to this value by pressing the following keys. The Pitch/CV output adjustment resolution is about 2 mV
  - C3 = decrement coarse
  - D3 = decrement fine
  - E3 = increment fine
  - F3 = increment coarse

### Saving the PITCH CV Calibration Settings

17. When you are done, you must press C#3 to save your calibration settings.  
**Note:** If you do not do this, your changes will not be saved.

### Exiting the PITCH CV Calibration Procedure

18. When you are finished, you must press C#4 to exit the Calibration Mode and return the MODEL D to normal operation.
19. If you want to do the other calibrations for the oscillators and octave range, follow the procedures shown on the next pages.
20. If you do not want to do any other calibrations, turn off the MODEL D, check the internal cables are securely connected, and secure its front panel assembly back onto the chassis using the 8 screws.

### Restoring the default PITCH CV settings

21. If you want to restore the Pitch CV calibration back to its factory settings, send the SysEx command shown below. (See the previous pages for details regarding the sending of SysEx messages.)

**F0 00 20 32 00 7F 0F 00 00 00 F7**

### 5.3 Oscillator Calibration

The oscillator calibration is done by following 3 main procedures: OSC1, OSC2, and OSC3. Each procedure is slightly different. OSC1 is calibrated by referring to the A-440 test tone, then OSC2 is calibrated against OSC1, and OSC3 is also calibrated against OSC1.

This calibration does not require the computer or SysEx, or the Voltmeter. The external keyboard is used, and adjustments are made to the various trim pots.

The PCB and the location of the trim pots is shown below.

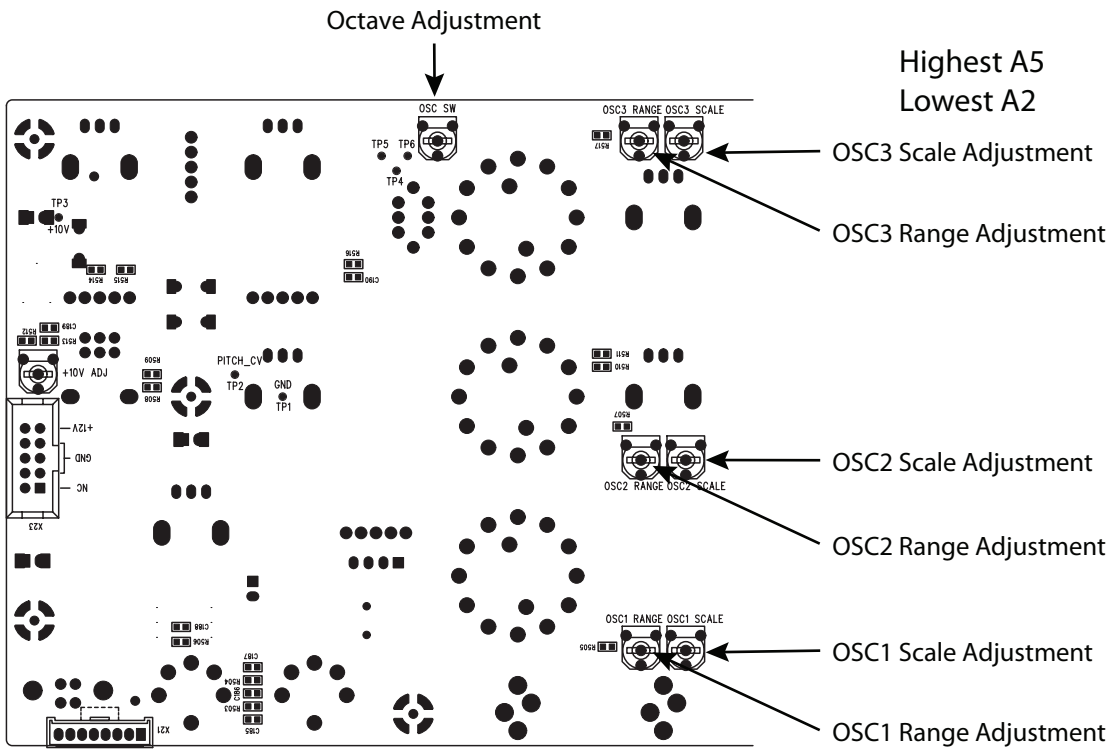

The diagram below shows the keyboard notes that are used in the calibrations. Only A2, A5, and C6 are used.

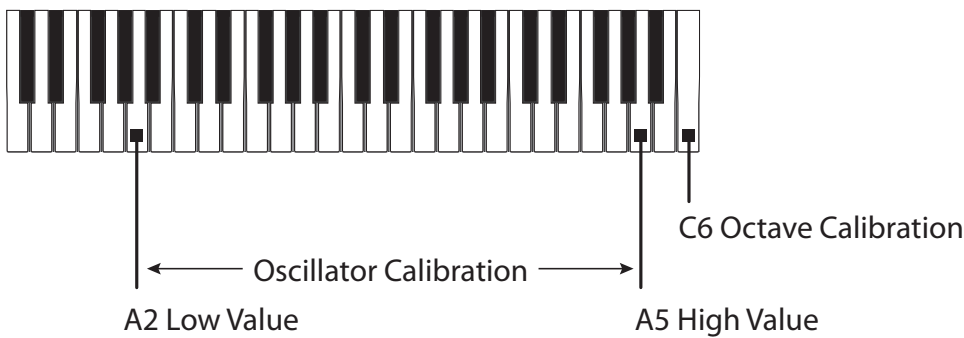

### 5.3.1 Procedure

1. Make sure that the preliminary procedures shown in section 5.1 have been followed, and the MODEL D front panel controls and switches are set as directed.

#### Osc1 Range and Scale Calibration

2. On the PCB, locate the OSC1 RANGE and OSC1 SCALE trimpots. (See PCB drawing on the previous page.)
3. As set up in the preliminary procedure, make sure the A-440 switch is ON. The A-440 test tone should be playing in your system.
4. On your external keyboard, press and hold the A5 key. Listen carefully, and adjust the OSC1 RANGE trimpot on the PCB for zero beats.
5. On your external keyboard, press and hold the A2 key. Listen carefully, and adjust the OSC1 SCALE trimpot on the PCB for zero beats.
6. Repeat steps 4 and 5 above until there are zero beats for either note. This may need to be repeated several times to get this right.
7. Turn OFF the A-440 switch.
8. Make sure the OSC1 switch is left ON for the next calibration.

#### OSC 2 Scale and Range Calibration

9. On the PCB, locate the OSC2 RANGE and OSC2 SCALE pots.
10. As set up in the previous procedure, the A-440 test tone should be off, and the OSC1 switch should be set on. Turn on the OSC2 switch.
11. On your external keyboard, press and hold the A5 key. Listen carefully to the combination of OSC1 and OSC2, and adjust the OSC 2 RANGE trimpot on the PCB for zero beats between them.
12. On your external keyboard, press and hold the A2 key. Listen carefully to the combination of OSC1 and OSC2, and adjust the OSC2 SCALE trimpot on the PCB for zero beats between them.
13. Repeat steps 11 and 12 above until there are zero beats for either note. This may need to be repeated several times to get this right.
14. Turn OFF the OSC2 switch.
15. Make sure the OSC1 switch is left on, for the next calibration.

#### OSC 3 Scale and Range Calibration

16. On the PCB, locate the OSC3 RANGE and OSC3 SCALE pots.
17. As set up in the previous procedure, the A-440 test tone should be off, and the OSC1 switch should be set on. Turn on the OSC3 switch.
18. On your external keyboard, press and hold the A5 key. Listen carefully to the combination of OSC1 and OSC3, and adjust the OSC3 RANGE trimpot on the PCB for zero beats between them.
19. On your external keyboard, press and hold the A2 key. Listen carefully to the combination of OSC1 and OSC3, and adjust the OSC3 SCALE trimpot on the PCB for zero beats between them.
20. Repeat steps 18 and 19 above until there are zero beats for either note. This may need to be repeated several times to get this right.
21. Turn OFF the OSC3 switch.
22. This completes the Oscillator Range and Scale Calibration.
23. If you want to do the other calibrations for the octave range, follow the procedures shown on the next pages.
24. If you do not want to do any other calibrations, turn off the MODEL D, check the internal cables are securely connected, and secure its front panel assembly back onto the chassis using the 8 screws.

EN

### 5.4 Octave Range Calibration

The octave calibration ensures that the OSC1 and OSC2 Octave RANGE knobs are in tune with each other. This calibration is done after the oscillator calibration.

1. Make sure that the preliminary procedures shown in section 5.1 have been followed, and the MODEL D front panel controls and switches are set as directed.
2. Turn OFF the A-440 switch, and keep the OSC1 VOLUME switch ON.
3. On the PCB, locate the OSC SW pot.

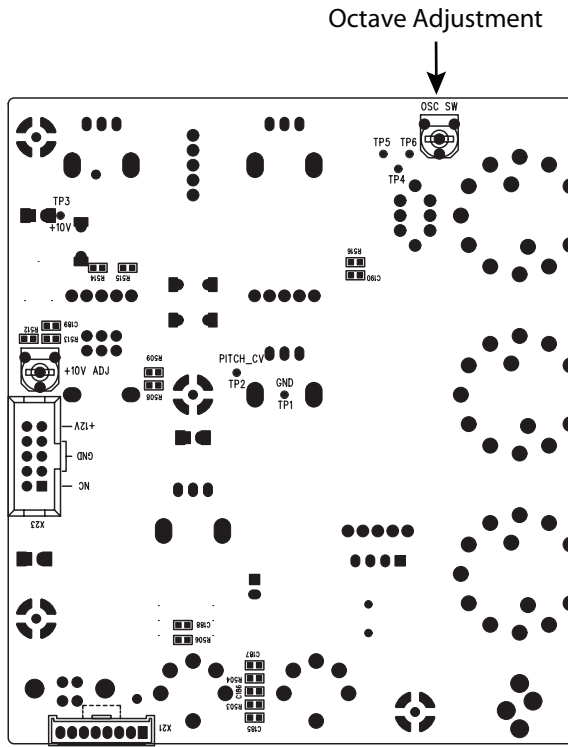

4. Turn all the Octave RANGE knobs to the 2' position in the OSCILLATOR BANK section.

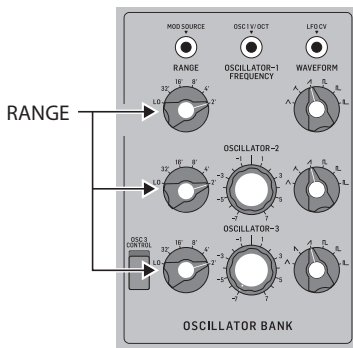

5. Turn on the front panel OSC2 VOLUME switch in the MIXER section. (OSC1 is already on, OSC1 and 2 Volumes are up).

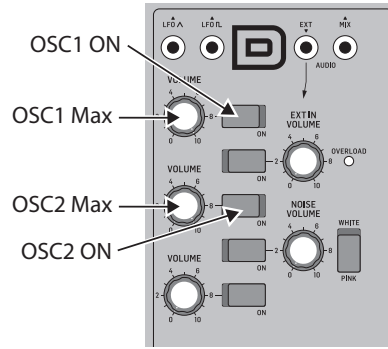

6. On your external keyboard, press and hold the C6 key. You should hear both OSC1 and OSC2. Adjust the headphone volume or main volume as required.
7. Listen carefully, and adjust the front panel OSCILLATOR-2 Tune knob until there are zero beats between OSC1 and OSC2.

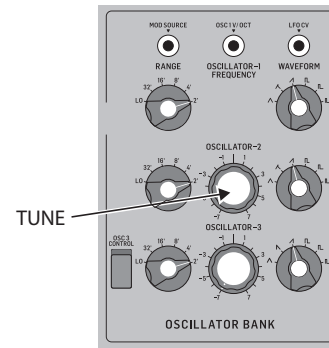

8. Turn the front panel OSC2 Octave RANGE knob to the 8' position.

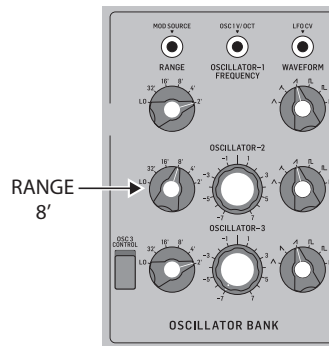



- On your external keyboard, keep holding the C6 key.

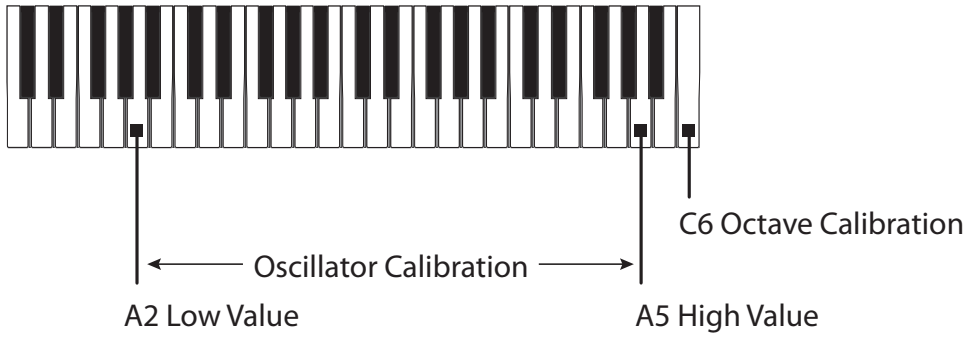

- Listen carefully, and adjust the OSC SW trimpot on the PCB, for zero beats between OSC1 (Range=2') and OSC2 (Range=8').

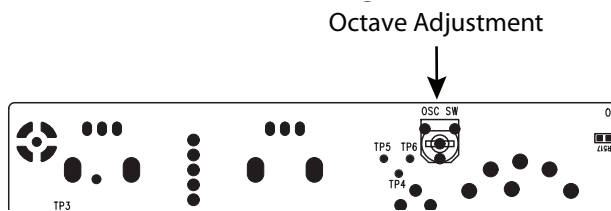

- Repeat step 8 with different settings of the RANGE knob, and repeat steps 9 and 10 until both oscillators are in tune with each other at all settings of the Octave RANGE knob.
- This completes the Octave Range Calibration.
- If you do not want to do any other calibrations, turn off the MODEL D, check the internal cables are securely connected, and secure its front panel assembly back onto the chassis using the 8 screws.

# 6. Hook-up examples

## 6.1 Studio System

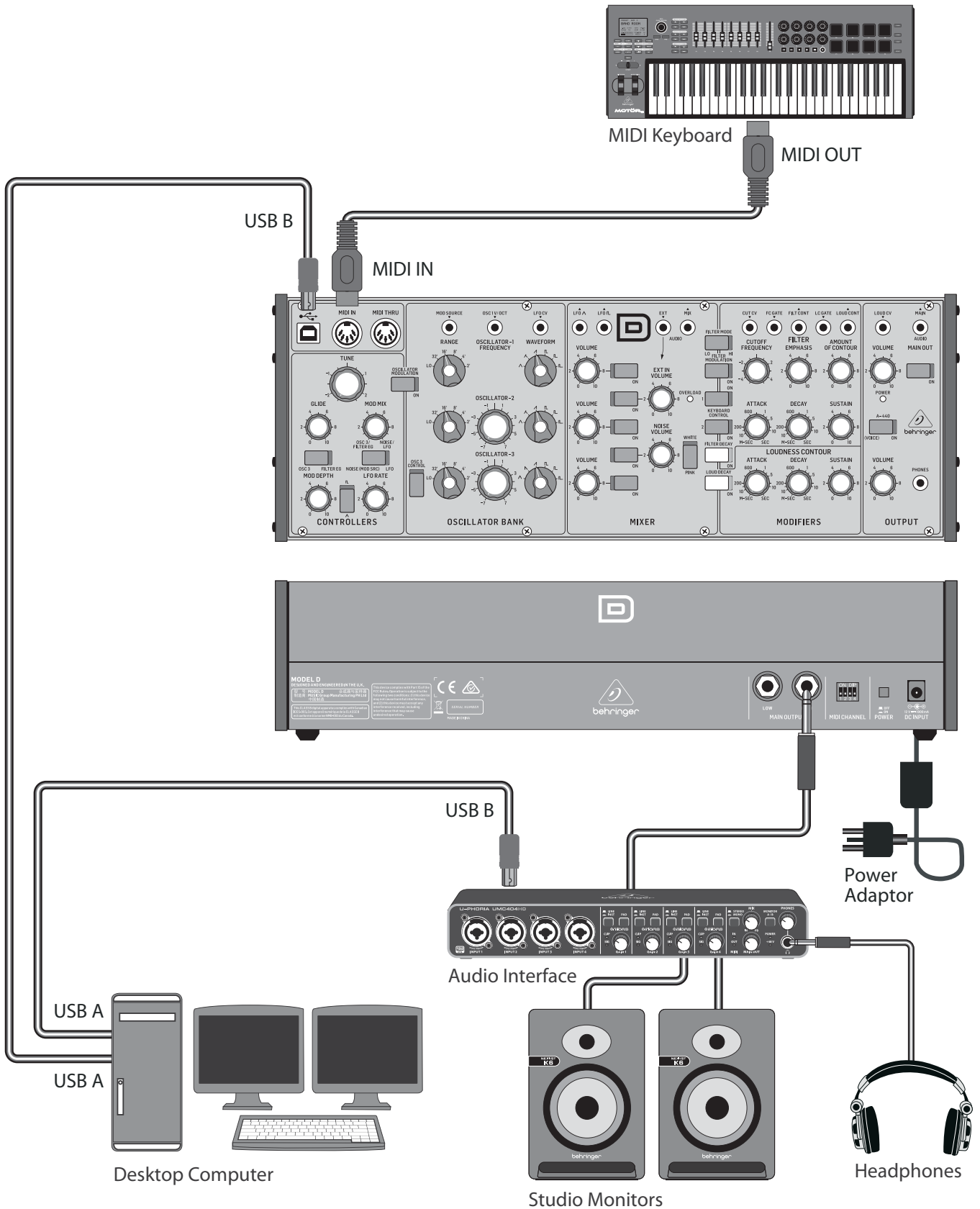

## 6.2 Band / Practice System

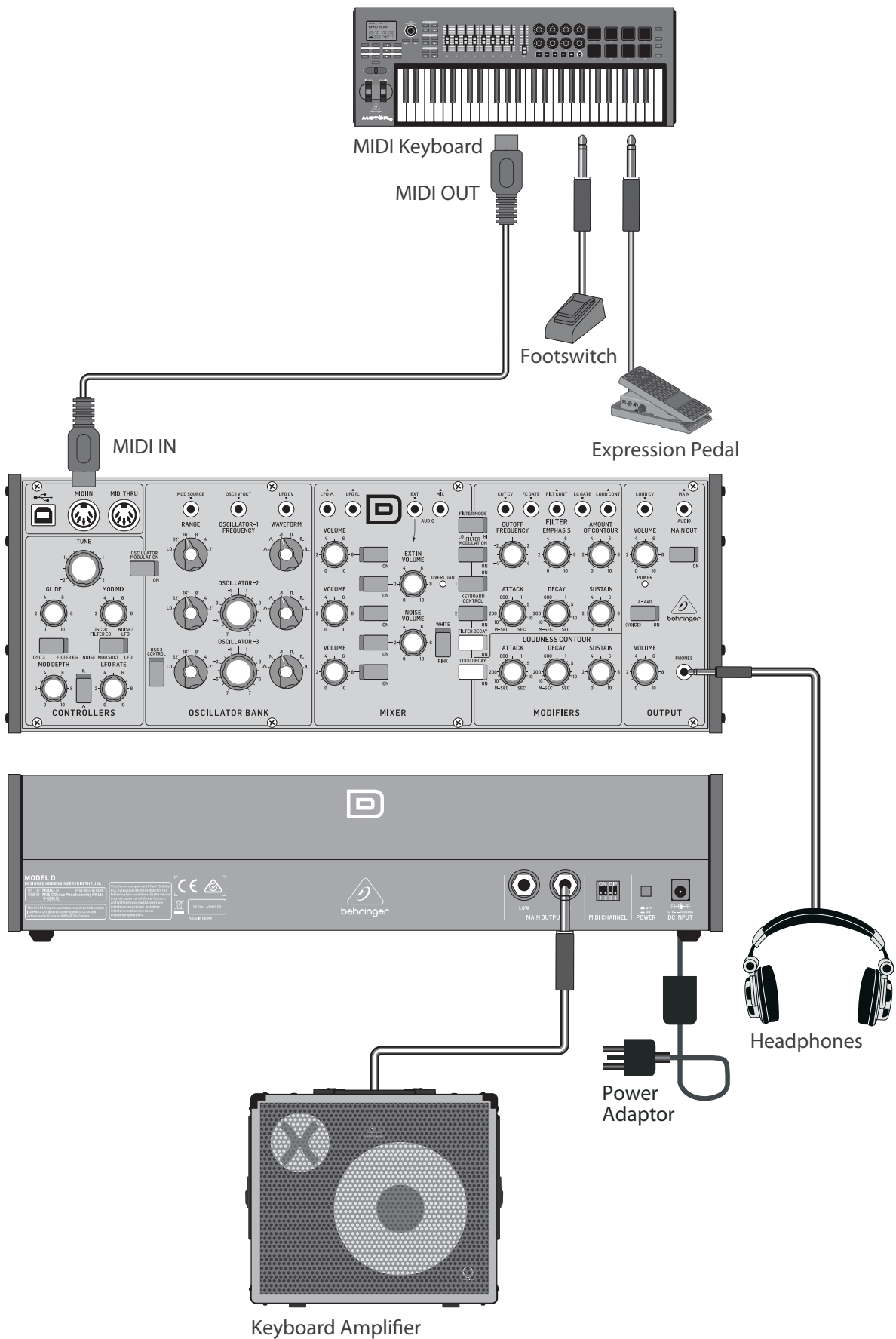

### 6.3 Live System

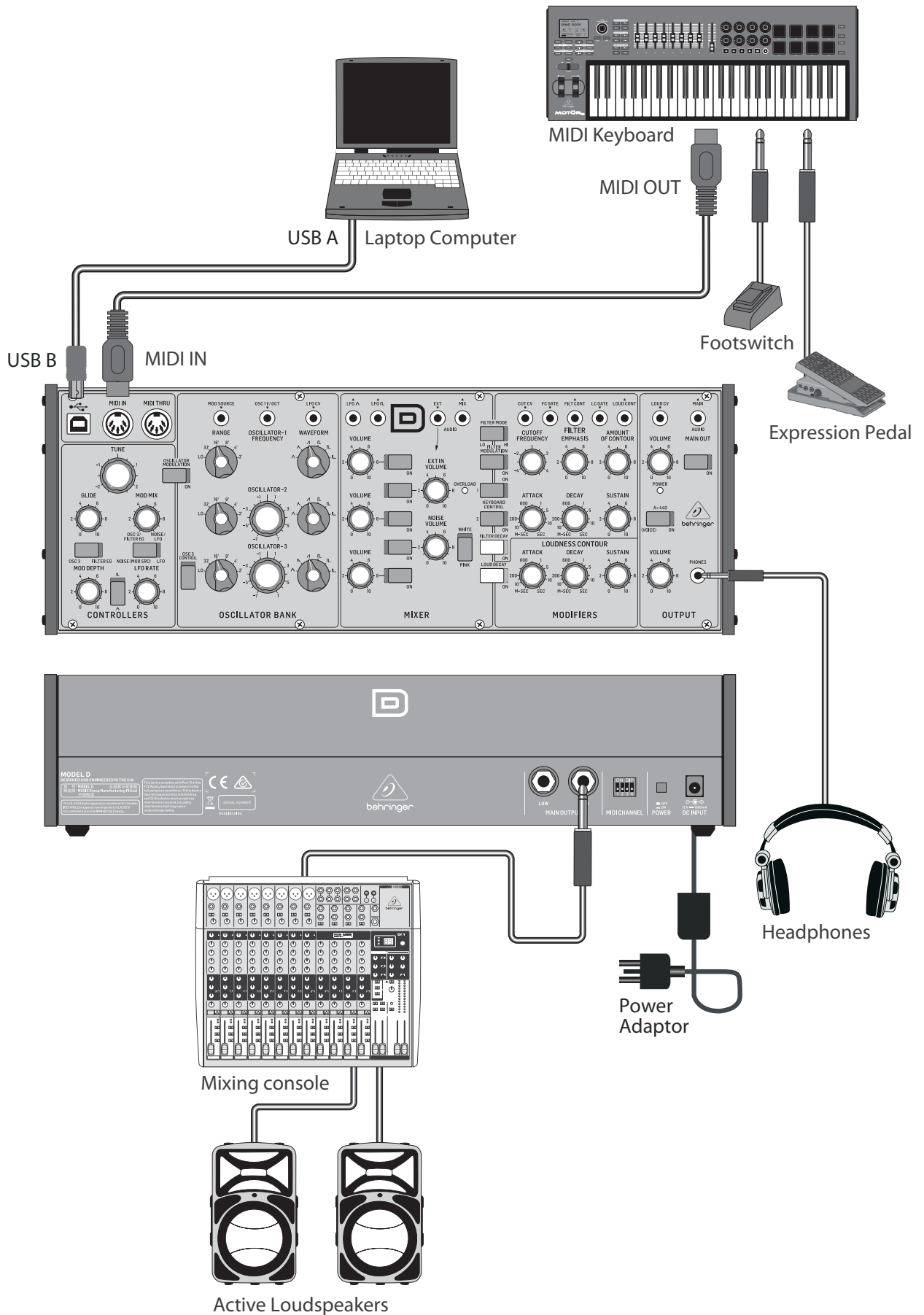

## 6.4 Poly Chain System

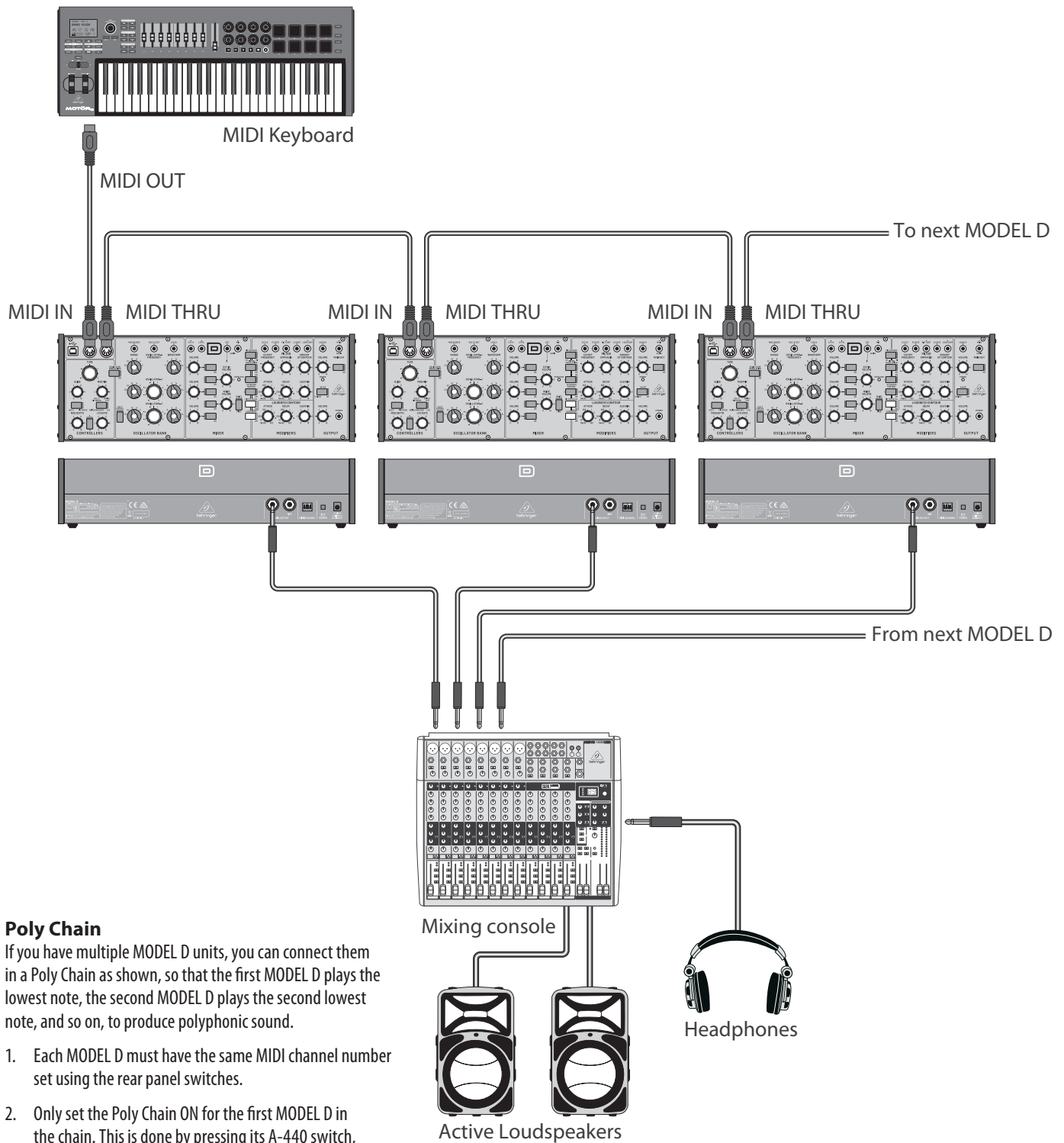

### Poly Chain

If you have multiple MODEL D units, you can connect them in a Poly Chain as shown, so that the first MODEL D plays the lowest note, the second MODEL D plays the second lowest note, and so on, to produce polyphonic sound.

1. Each MODEL D must have the same MIDI channel number set using the rear panel switches.
2. Only set the Poly Chain ON for the first MODEL D in the chain. This is done by pressing its A-440 switch, "on, off, on, off" within the first few seconds of powering on. The Power LEDs will flash **fast** four times when Poly Chain is **ON**. The other MODEL D units will automatically work in Poly Chain mode once the first unit is set up like this.
3. Adjust the controls of each MODEL D to be the same, similar, or experiment as required.
4. If the Poly Chain system is no longer required, turn off the Poly Chain mode of the first MODEL D by repeating step 2. The Power LEDs will flash **slowly** four times when Poly Chain is OFF.

## EN 7. System Exclusive Commands

Some parameters in the MODEL D synthesizer can be changed using MIDI system exclusive (SysEx) commands.

A MIDI utility such as the popular MIDI OX can be used to send the SysEx command data string to the MODEL D using the USB MIDI connection between a host computer and the MODEL D.

Section 5.2 shows a typical procedure for sending a SysEx message to the MODEL D, and it can be used to send any of the following SysEx messages.

### 7.1 SysEx Data Format

The following data format is used when creating a SysEx message (with the data beginning with F0 and ending with F7).

#### F0 00 20 32 aa bb cc dd ee ff F7

The various items in this SysEx data string are described below:

Item	Description
00 20 32	Manufacturer SysEX ID number (Behringer GmbH)
aa	Reserved
bb	Device ID: 00-0xF (must match hardware device ID), or 7F to address all devices. <b>Note:</b> This is the same as the Poly Chain ID. It is not the MIDI Channel
cc	Main parameter number (see Command Table below)
dd	Sub parameter number (see Command Table below)
ee	Parameter value MSB (will be zero unless the parameter value is greater than 127)
ff	Parameter value LSB (Range is 0 to 127) (see Command Table below)

### 7.2 Command Table

cc (Main)	dd (Sub)	Description	ff (Para Range)	Default
	00	MIDI Channel	0 to 15	0
	01	Key Priority	0-LOW 1-HIGH 2-LAST	0-LOW
	02	Multi Trigger	0-OFF 1-ON	0-OFF
	03	Pitch Bend semitones (Pitch wheel range)	0 to 12	12
	06	MIDI IN Transpose	0 to 24 The range is -12 to + 12, so 12 is no transpose	12
OxA Global Setting	07	MIDI Note Zero Volts	0 to 127	36
	08	Poly Chain* see note below	0-OFF, 1-ON	0-OFF
	09	Device ID (Poly Chain ID)	0-15	0
	0A	Enable/Disable MIDI Channel Switches	0- Enable 1-Disable	0- Enable
	0B	Modulation Curve	0-Soft 1-Med 2-Hard	0-Soft
	0xB	Restore Global Settings		
	0xE	Start User Pitch CV Calibration		
	0xF	Restore Default CV Calibration		

**\*Note:** If you use SysEx instead of the recommended A-440 method to turn on the Poly Chain, then the Poly Chain Device ID of other units in the chain will not be set automatically. You have to use SysEx to set the Poly Chain ID of the first MODEL D to Device ID=0, the second MODEL D to ID=1, the third MODEL D to ID=3 and so on. All MODEL D units must have the same MIDI channel.

## 7.3 Command Examples

**Note:** All command parameters should be in hexadecimal format.

Function	SysEX Command String
Set MIDI Channel to 13	F0 00 20 32 00 7F 0A 00 00 0C F7
Set Key Priority to last	F0 00 20 32 00 7F 0A 01 00 02 F7
Turn on Multi Trigger	F0 00 20 32 00 7F 0A 02 00 01 F7
Set Pitch Bend semitone to 11	F0 00 20 32 00 7F 0A 03 00 0B F7
Set MIDI IN Transpose to +8	F0 00 20 32 00 7F 0A 06 00 14 F7
Set Note C5 as Zero Volts	F0 00 20 32 00 7F 0A 07 00 48 F7
Turn on Poly Chain	F0 00 20 32 00 7F 0A 08 00 01 F7
Set Device ID to 5	F0 00 20 32 00 7F 0A 09 00 05 F7
Disable MIDI Channel Switches	F0 00 20 32 00 7F 0A 0A 00 01 F7
Set Modulation Curve to Medium	F0 00 20 32 00 7F 0A 0B 00 01 F7

**Note:** A decimal to hex conversion table is shown below. If you are using the MIDI Transpose command, then the 3rd column shows the MIDI IN Transpose that corresponds to each data value. For example, if you wanted a transpose of +8 as shown in the table above, then the data sent is 14 (hex).

Value	Value (hex)	MIDI Transpose
0	0	-12
1	1	-11
2	2	-10
3	3	-9
4	4	-8
5	5	-7
6	6	-6
7	7	-5
8	8	-4
9	9	-3
10	A	-2
11	B	-1
12	C	0
13	D	1
14	E	2
15	F	3
16	10	4
17	11	5
18	12	6
19	13	7
20	14	8
21	15	9
22	16	10
23	17	11
24	18	12

## EN 8. Eurorack Installation

The MODEL D synthesizer can be removed from its factory chassis and installed into a standard Eurorack chassis (not supplied). The module width is 70HP.

We recommend that this procedure is undertaken only by an experienced service technician, to prevent personal injury, or damage to the unit.

The Eurorack case will need its own suitable power supply unit to power the MODEL D synthesizer.

A 10-pin connector on the rear of the main PCB of the MODEL D allows the +12 VDC power supply connection to be made. A 10-pin to 16-pin adapter ribbon cable is supplied to connect to your power supply.



Before proceeding, make sure that your power supply is capable of supplying +12 VDC, 1 Amp.



Make sure that the connections using the supplied adapter cable will supply the ground and power to the correct pins of X23.

### 8.1 Procedure

Follow all steps in the order in which they are presented.

1. Disconnect the power cord and all other connections to the MODEL D.
2. Undo the 8 screws on the top panel as shown. There is no need to undo any other screws.

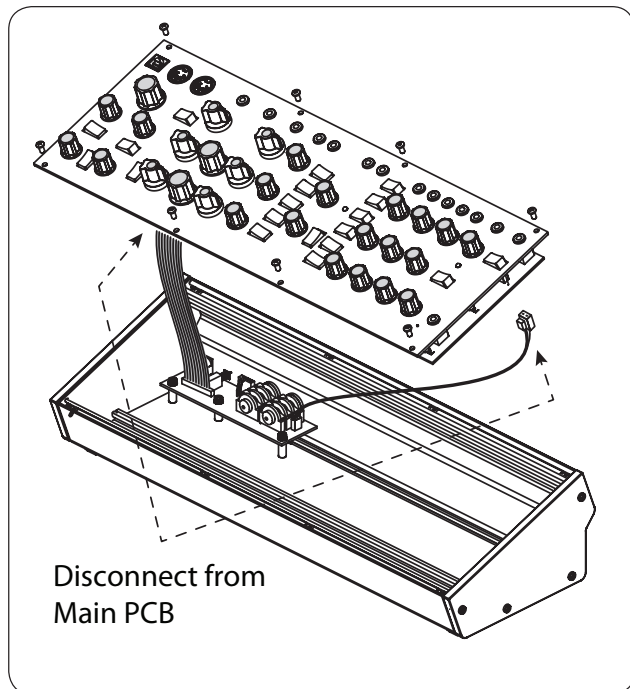

3. Disconnect the two cables from the lower side of the main PCB of the MODEL D, and remove the assembly from the chassis.
4. Store the chassis assembly and the power supply adaptor in a dry safe place.

5. Securely connect the 10-pin end P1 of the supplied adapter cable to connector X23 on the Main PCB of the MODEL D.

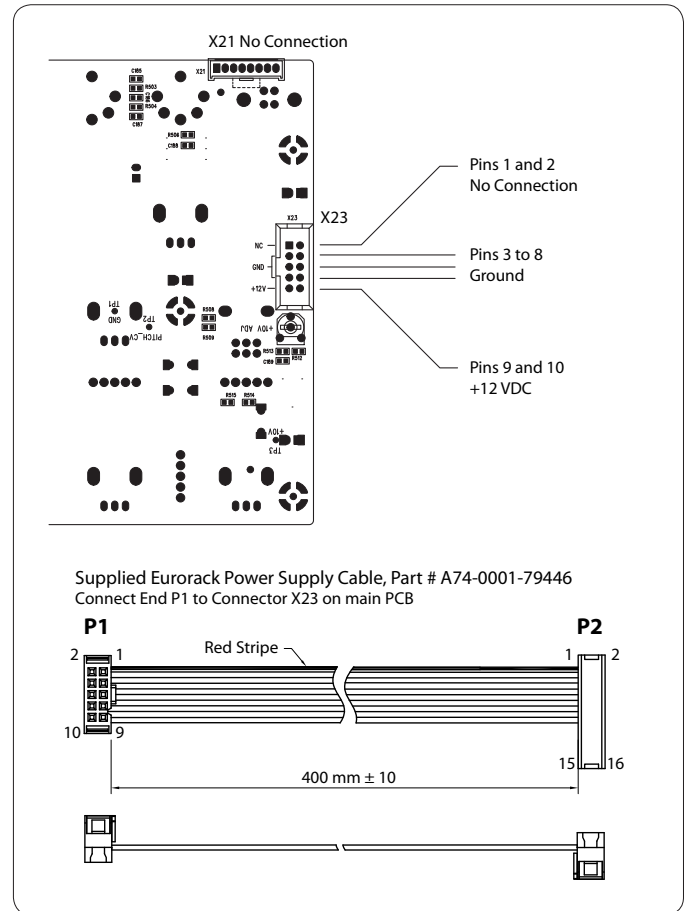

6. Make sure your power supply is turned off and disconnected from the AC mains.
7. Make sure that your power supply will supply the following to the pins of connector X23, as shown in the diagram above.

Pins	Connection
1 and 2	No Connection
3 to 8	Ground
9 and 10	+12 VDC

8. Securely connect the 16-pin end P2 of the supplied adapter cable to your power supply, and double check all connections are correct.
9. Securely install the MODEL D Synthesizer into your Eurorack, using 8 screws in the front panel.
10. Perform a full test and safety test before using the MODEL D.
11. The 3.5 mm MAIN OUT connector on the top panel is used instead of the ¼" rear outputs which are no longer present.



## 8.2 Setting the MIDI Channel

Once installed in a Eurorack, the MIDI channel number is automatically set to channel 1 (as the MIDI switches are no longer present.)

The MIDI channel can be changed using MIDI OX or a similar MIDI utility on your computer to send MIDI SysEx commands directly to the MODEL D via the USB MIDI connection. Here is a brief guide to the procedure (see the MIDI SysEx pages in this manual for the actual SysEx codes sent to the MODEL D):

1. Disable the MIDI Channel Switches by sending the appropriate SysEx command (even though the switches are no longer present).
2. Change the MIDI Channel by sending the appropriate SysEx command.

## 9. Specifications

### Synthesizer Architecture

Number of voices	Monophonic
Type	Analog
Oscillators	3 (0.1 Hz to 20 kHz in 6 overlapping ranges)
LFO	1 (0.05 Hz to 200 Hz, up to 300 Hz with external CV input)
VCF	1 switchable low pass or high pass (24 dB/octave slope)
Envelopes	VCA, VCF

### Connectivity

MIDI In/Thru	5-pin DIN / 16 channels
USB (MIDI)	USB 2.0, type B
High output	¼" TS, unbalanced, max. 0 dBu
High output impedance	1.2 kΩ
Low output	¼" TS, unbalanced, 30 dB below high output
Low output impedance	1 kΩ
Headphones	3.5 mm TRS, unbalanced, max. -3.5 dBu
Headphones output impedance	8 Ω

### USB

Type	Class compliant USB 2.0, type B
Supported Operating Systems	Windows XP or higher Mac OS X 10.6.8 or higher

### Controllers Section

Knobs	Tune: -2 to +2 Glide: 0 to 10 Modulation mix: (OSC 3 or filter EG) to (noise/ext mod source, or LFO) Modulation depth: 0 to 10 LFO rate: 0 to 10
Switches	Modulation source: OSC 3 or filter EG Modulation source: (noise or external modulation source) or LFO LFO waveform: triangular or square

### Oscillator Bank

Knobs	Range (OSC 1, 2, and 3): L0, 32', 16', 8', 4', 2' Frequency (OSC 2 and 3): -7 to +7 Waveform (OSC 1 and 2): triangular, triangular/saw, saw, square, wide pulse, narrow pulse Waveform (OSC 3): triangular, reverse saw, saw, square, wide pulse, narrow pulse
Switches	Oscillator modulation on/off OSC 3 control (by keyboard) on/off

### Mixer Section

Knobs	Volume (OSC 1, 2, and 3): 0 to 10 Volume (external input): 0 to 10 Volume (noise): 0 to 10
Switches	OSC 1, 2, and 3: on/off External input: on/off Noise: on/off Noise source: pink or white
LED	Overload

### Filter Section

Knobs	Cutoff frequency: -4 to +4 Filter emphasis: 0 to 10 Amount of contour: 0 to 10 Attack: 1 ms to 10 s Decay: 4 ms to >35 s Sustain: 0 to 10
Switches	Filter mode: low pass/high pass Filter modulation: on/off Keyboard control 1: on (½) or off Keyboard control 2: on (¾) or off Filter decay: on/off

### Output Section

Loudness contour dynamic range:	80 dB
Knobs	Volume: 0 to 10 Headphone volume: 0 to 10 Amount of contour: 0 to 10 Attack: 1 ms to 10 s Decay: 4 ms to >35 s Sustain: 0 to 10
Switches	Main output: on/off A-440: on/off Loudness decay: on/off
LED	Power

### Inputs (TS 3.5 mm)

Modulation source	Noise is the modulation source if there is no connection present
Oscillator 1	Control voltage: 1 V per octave
LFO	Control voltage: -5 V to +5 V
External input	Input impedance: 1 MΩ
Cutoff frequency	Control voltage: 0 to +5 V controls the cutoff frequency
Loudness	Control voltage: 0 to +5 V controls the loudness
Filter contour	Gate: +5 V input triggers the filter contour
Loudness contour	Gate: +5 V input triggers the loudness contour

### Outputs (TS 3.5 mm)

LFO triangular waveform	+/-2 V
LFO square waveform	+/-2 V
Mixer output	max. 0 dBu
Filter contour	0 to +4 V
Loudness contour	0 to +4.6 V
Main audio output	max. 0 dBu

### Power Requirements

External power adaptor	12 VDC 1000 mA
Power consumption	7 W max.

### Environmental

Operating temperature range	5°C – 40°C (41°F – 104°F)
-----------------------------	---------------------------

### Physical

Dimensions (H x W x D)	90 x 374 x 136mm (3.5 x 14.7 x 5.4")
Module width	70HP
Weight	1.7 kg (3.7 lbs)
Shipping weight	2.7kg (6.0 lbs)



## 10. Glossary

This glossary provides an explanation of useful symbols, terms and abbreviations.

**32'/16'/8'/4'/2'**: Used to describe the range of an oscillator, this term originates from pipe organs. The length of the pipe is inversely proportional to the pitch it produces, for example, a 4' pipe is one octave higher than an 8' pipe.

**ADC or A/D**: Analog to Digital Converter, used to describe the process of signal conversion

**AC**: Alternating Current

**ADSR**: Attack, Decay, Sustain and Release, an envelope with four stages.

**Amplifier**: A circuit which increased the level of a signal.

**Amplitude Modulation (AM)**: Modulation of the amplitude (or level) of a sound by another signal source. AM is used to produce tremolo using a low frequency modulation source.

**Analog**: Something which is proportional or similar to something else. In the case of the synthesizer, audio electronic circuits are another form of air pressure waves. Analog signals contain distortions from the components, topology, circuits and designs which are often perceived as warmer and more natural than their digitally generated counterparts.

**Arpeggiator**: An "Arpeggio" is a number of notes played sequentially instead of simultaneously. Some external keyboards have an Arpeggiator that responds to a number of keys being held by playing a sequence of notes.

**Attack Time**: The first stage of an ADSR envelope, used to control the initial part of a sound. Specified as the duration of time for an envelope to reach the maximum level after it has been triggered on by a key press or gate signal.

**Attenuate**: To reduce the level of a signal.

**Automation**: The recording and playback of control signals.

**Balanced Audio**: A type of audio connection that uses the three wires in a cable as part of a phase-cancelling arrangement to boost the signal and reduce noise.

**Band**: A range of frequencies.

**Bandwidth**: The difference between the upper and lower frequencies of a filter.

**Bass**: Lower frequencies in a signal ranging from 60 Hz to 250 Hz (Approximately B1 to B3).

**Beat Frequency**: When two waveforms of different frequencies are mixed together, the resulting waveform will have points of constructive and destructive interference. The beat frequency is equal to the difference in frequencies and is heard as a "beating" or amplitude modulation.

**Beats Per Minute (BPM)**: Used to describe the tempo of a composition by specifying the number of beats which should occur in every minute.

**Cent**: Unit of measurement for pitch tuning. There are one hundred cents in a semitone.

**Chorus**: An effect which uses multiple copies of a signal played together and slightly out of time, to create a shimmering effect. Sometimes referred to as "Ensemble".

**Clock**: A digital waveform typically square which is used as a timing source for other components in a system.

**Continuous Controller**: A type of MIDI message assigned to a specific parameter. When the parameter is adjusted a continuous controller messages are sent. If the assigned continuous controller is received then the parameter will be adjusted.

**Control Voltage (CV)**: A voltage signal used to control any parameter. Was common on synthesizers before MIDI, and is now found mostly on modular synthesizers.

**Cross-Modulation (X-Mod)**: Two oscillators modulating each other at the same time. The outputs is a mix of the sum and difference of the oscillators. The term is also used to describe the ability for parameters of a synthesizer to be able to modulate other parameters.

**Cut-Off Frequency**: The frequency which a filter is set to. Beyond this frequency (in a low-pass filter, the most common), the sound is cut off (attenuated) at a rate set by the slope of the filter response curve.

**Cycle**: In a sound wave, the cycle refers to a single repetition of a wave-shape. For example, in a square waveform, it is the time from a positive edge to the next positive edge.

**DAC or D/A**: Digital to Analog Converter, used to describe the process of signal conversion

**Data**: Digitally stored information

**dB**: Symbol for "decibel". A unit of measurement of the loudness of sound. See dBu.

**dBu**: A unit of measurement of sound used in professional audio. Derived from the decibel, where the "u" stands for unloaded, this unit is an RMS measurement of voltage based on 0.775 VRMS, which is the voltage at which you get 1 mV of power in a 600 Ohm resistor. This used to be the standard impedance in most professional audio circuits.

**DC Offset**: An imbalance that sometimes occurs in A/D converters. It is a constant voltage that is present, which can eat up headroom and cause clicks and pops during editing.

**Decay Time**: The second stage of an ADSR envelope. Specified as the duration of time for an envelope to reach the sustain level after the maximum level has been reached during the attack stage.

**Default**: An initial value for parameter, i.e., the value before any changes have been made.

**Delay**: An effect by which a reproduction of a signal is played back later than its original. Primarily used for echo, but also is the basis for phasing, flanging, chorus and basic reverb type effects.

**Detuning**: The action of adjusting the pitch of an oscillator from a reference point or another oscillator. When oscillators are detuned slightly they will make the output sound "fatter" or "wider". When oscillators are detuned heavily to note intervals it can create harmonies.

**Digital Audio Workstation (DAW)**: A computer based recording system. More commonly used to describe the software package used to record, process and mix.

**Digitally Controlled Oscillator**: An analog oscillator circuit controlled and monitored by a digital processor. The advantages over a VCO is increased stability which results in far less tuning drift.

**Digital Signal Processing (DSP)**: The numerical manipulation of signals, usually with the intention to measure, filter, change, effect, produce or compress continuous analog signals.

**Distortion**: An effect based on pushing the boundaries of what a specific technology or implementation can achieve. At the point where technology begins to overload, overdrive, clip, saturate or generally misbehave is where distortion starts to appear. Examples include tape, valve, transistors, and also digital algorithms and processes.

**Dynamic**: The range of levels in an audio signal, from the softest to the loudest.

**Dynamic Processor**: A device used to control and/or change the dynamics of a signal.

**Dynamic Range**: The difference between the lowest level and the highest level an audio system can produce.

**Effect:** One of a number of audio processes that can be applied to a signal to modify it, such as reverb, flanging, phasing, delay etc.

**Effects Send:** A copy of the channel signal which is sent to an effects processor in order for it to be returned.

**Effects Return:** An effected audio signal which is returned to mix with the original channel signal.

**Envelope Generator (EG):** An envelope signal which can be adjusted to a specific shape in order to control the way a sound behaves over time.

**Equalisation (EQ):** Processor used to adjust the volumes of various frequency ranges for creative or corrective purposes.

**Exponential:** A mathematical function of growth or decay where the independent variable is the exponent. This results in a "hockey stick" shaped curve.

**Expression Pedal:** A Pedal which can be connected to an expression input and used to send a control signal dependant on the position of the pedal. The control signal can then be used to modulate other parameters, and/or to add expression.

**Fader:** A physical linear control also known as a slider, or slide potentiometer which can be used to adjust a parameter.

**Feedback:** A loop created between an audio input and an audio output of an audio circuit, system or processing block.

**Filter:** A device that attenuates certain frequencies while letting other frequencies through. Using a filter to reduce harmonics, changes the timbre or color of the sound.

**Frequency Modulation (FM):** Using one frequency to modulate another frequency's pitch. When the modulation source is in the audio range, it can be perceived as a change in the timbre or color of the sound. FM can be used to create a wide range of rich and complex sounds and is often described as having a clear and distinctive timbre.

**Frequency:** The number of times that a sound waves cycle repeats within one second.

**Fundamental Frequency:** The lowest frequency of a periodic waveform.

**Gain:** The amount of signal level increase provided by an amplifier stage.

**Gate (Synthesizer):** A signal used to trigger an event, such as a note or an envelope.

**Gate (Dynamics):** A device used to cut off the level of a signal when it falls below a specified threshold. Can be used to cut background noise, control reverb tails, or creatively to produce chopping type effects.

**Glide:** See Portamento.

**Global:** The settings and parameters which govern the general operation of the synthesizer and are not directly associated with the voice engines.

**Harmonics:** A series of integer-related sine waves at varying levels creating different timbres. Waveforms (other than a pure sinusoidal) generate various harmonics which help define the character of the sound.

**Hertz (Hz):** A unit of frequency equal to one cycle of a wave per second.

**High Pass Filter (HPF):** A filter that attenuates lower frequencies from a signal, leaving the higher frequencies unaffected.

**Hum:** Undesirable low-frequency tone (typically 50 or 60 Hz) present in a signal due to grounding problems or proximity to a power source or power cables.

**Impedance (Z):** Opposition to the flow of alternating current in a circuit, measured in Ohms.

**Insert:** A point in a processing chain where a device can be inserted.

**Keyboard:** A range of keys, arranged in order of ascending pitch, which enables the synthesizer to be played by hand.

**Keyboard Tracking:** Allows the control signal from played keys to adjust another parameter. Commonly used to open a filter as higher notes are played which then enhances harmonics.

**Kilohertz (kHz):** A unit of frequency equal to one thousand cycles of a wave per second.

**Latency:** A delay introduced by processing. Measured by the time it takes to produce a signal after a request has been made. In a synthesizer, it is the time taken to produce a note after a key has been played. In an audio interface, it is used to measure the time it takes for an input signal to reach the processor, or for a signal from the processor to reach the output.

**Level:** Used to describe the magnitude of a sound, often relative to an arbitrary reference.

**Limiter:** A device used to limit the level to a range of values irrespective of the input level.

**Linear:** Used in audio to describe a straight line response of circuit or process which results in a change which is directly proportional to an independent variable.

**Line Level:** A nominal operating level used by audio equipment. Professional line level is normally +4 dBu and consumer line level is -10 dBv.

**Looping:** Automatically restarting a function at the end of a period of time or defined cycle, to create a continuous loop.

**Low Frequency Oscillator (LFO):** An oscillator that commonly runs at a very low speed and is used to modulate another parameter.

**Low Pass Filter (LPF):** A filter that attenuates higher frequencies from a signal, leaving the lower frequencies unaffected.

**Mark to Space Ratio:** The ratio between the positive and negative parts of a rectangular waveform, or pulsewave.

**Meter:** Visual device to indicate the level of a signal.

**MIDI (Musical Instrument Digital Interface):** A technical standard that describes a protocol, digital interface and connectors and allows a wide variety of electronic musical instruments, computers and other related hardware/software devices to connect and communicate.

**MIDI Clock:** A clock signal which is broadcast over MIDI to ensure that devices are synchronised. Also known as MIDI Beat Clock or MIDI Timing Clock.

**MIDI Message:** Data or information transmitted from one MIDI device to another. Each MIDI message contains at least two numbers: one that identifies the type of message being sent, and another which represents a value for the selected type of message.

**Midrange:** Frequencies in a signal ranging from 250 Hz to 5 kHz (Approximately B3 to D#8).

**Mix:** The balance of level between one signal and another.

**Mixer:** A device that blends input signals into composite signals for output.

**Modular Synthesis:** A synthesis system comprised of a number of modules which can be connected in many different ways. Modules can perform a single function such as an oscillator or filter or perform multiple functions.

**Modulation:** The process of controlling one or more properties (destinations) of a signal using another signal (source).

**Modulation Wheel (Mod Wheel):** A wheel located to the left of a keyboard that allows you to change specified parameters in real-time.

**Monitors:** Studio quality loudspeakers, providing an accurate representation of the audio signals.

**Mono:** A single signal.

**Monophonic:** Only one note can be played at any given time, as there is only a single voice.

**Mute:** Function that allows a signal to be silenced.

**N/A:** Abbreviation for "not applicable" or "not available".

**Noise Generator:** A circuit or process that produces a random (or aperiodic) signal. The frequency response can differ depending on the type of noise.

**Note-Priority:** Determines which note is played when more notes are held simultaneously than the number of available voices (often: low/high/last).

**Octave or Oct:** Unit of measurement for pitch. Every time the frequency of a waveform doubles, the pitch increases by one octave.

**Ohm ( $\Omega$ ):** Unit of electrical resistance.

**Oscillator:** An electronic device which generates a periodic signal used to form the basis of a synthesizer program.

**One Shot:** A single event that has to be triggered each it is required.

**Output:** The signal sent out by a device or process. Also used to describe the physical socket where a signal leaves a device.

**Overtone:** Any frequency that is present in a waveform that is higher than the fundamental frequency of that waveform.

**Pad:** A program that is usually characterized by slow attack and release times.

**Panning / Pan:** The positioning of a signal within a stereo image.

**Parameter:** A setting whose value can be changed.

**Parametric EQ:** A type of EQ that allows all of the parameters of equalisation to be changed, including centre frequency, boost/cut in gain and bandwidth.

**Partial:** Any of the sinusoidal waveforms which form part of a complex tone.

**Patch:** The cables used on modular synthesizers (or synthesizers with modular compatibility) to connect devices together. Patch cables can carry audio, gate or control voltage signals.

**Period:** The time that it takes a wave to complete a full cycle. Period is calculated by dividing 1 by the frequency

**Phase:** A measurement (in degrees) of the time difference between two waveforms, or between a single waveform and a reference point.

**Phaser:** An effect which uses a series of notched all-pass filters (also called stages) to create a comb-filter response which does not always have harmonic relationships between the notches. The result is a sweeping effect similar to a flanger but smoother and often more natural sounding.

**Pink Noise:** A type of signal that has equal power in each band. Human hearing is roughly logarithmic, therefore each octave is discerned to have an equal amount of power across the audible spectrum.

**Pitch:** A quality of sound that makes it possible to judge if a sound is higher or lower than another.

**Pitch Bend / Pitch Bend Wheel:** Controlling the pitch of a note after it has been played.

**Pitch Shift:** Alteration of pitch or frequency, but without adjusting tempo.

**Pole:** A section of a filter stage. The more poles a filter has, the steeper its attenuation slope will be, and the more accurate the filter will be.

**Polyphonic:** Capable of playing more than one note at once.

**Polyphony:** The number of notes a polyphonic synthesizer can play simultaneously.

**Portamento:** An adjustable performance effect that glides or bends the pitch from one note to the next.

**Post:** The point for accessing audio just after it leaves a specific component or stage. For example Post-Fader audio is affected by the fader.

**Pre:** The point for accessing audio just before it reaches a specific component or stage. For example, Pre-Fader audio is not affected by the fader.

**Preset:** A program or part of a program that is built into synthesizer patches that are sometimes fixed and sometimes editable.

**Program:** A complete set of parameters and settings which the synthesizer uses to create a specific sound.

**Power Supply Unit (PSU):** The component in a system which is responsible for supplying and managing power.

**Psychoacoustics:** The study of the perception of sound, that is, how we listen, our psychological responses, and the physiological effects on the human nervous system.

**Pulse Wave:** Similar to a square wave, but without symmetry. Also known as a "Rectangle Wave."

**Pulse Width Modulation (PWM):** Modulation of the pulse width (the duty cycle of a pulse wave measured as a percentage). A pulse width of 50% has equal positive and negative sections and is considered a square wave.

**Q Factor:** A bandwidth (or selectivity), of a particular band in an equalizer. The higher the Q Factor, the wider the bandwidth.

**Rate:** The speed at which a particular device is operating.

**Release Time:** The fourth and final stage of an ADSR envelope. Specified as the duration of time for an envelope to reach zero after the played key is released.

**Resonance:** The emphasis/boost of frequencies around the cut-off point just before attenuation starts to occur. As resonance increases, it will reach a point where the filter will start to self oscillate, producing a signal even when there is no input.

**Reverb:** An effect where the ambience of a physical space is simulated.

**s:** Symbol for "second," a unit of time.

**Sample Rate:** The number of digital samples used every second to represent an analog waveform.

**Sample Resolution (Bit Depth):** The number of digital bits used to define the amplitude of an analog signal. Higher resolution results in greater dynamic range.

**Sawtooth:** A waveform that combines an instantaneous rise or fall, followed by a gradual linear incline or decline. The name comes from the waveform's similarity to the teeth of a saw.

**Semitone:** A chromatic half-step. There are twelve semitones in an octave.

**Sequencer:** A programmable device or module used to arrange/sequence timed events into musical patterns and songs.

**Self-oscillation:** Occurs when the resonance of a filter is increased to the point where it will begin to generate a sine wave independently of any input.

**Signal flow:** The path of a signal from one module (or component of a system) to another.

**Sinusoidal / Sine Wave:** Mathematical description of a smooth waveform that contains only the fundamental frequency and has no additional harmonics. The shape resembles the letter "S" rotated 90 degrees.

**Slew Rate:** The rate of change of a voltage or control signal.

**Spectrum:** First used to describe the full range of colors in visible light, the term is also used to describe the full range of frequencies in the audio spectrum.

**Square Wave:** A symmetrical waveform that combines an instantaneous rise or fall, followed by a positive or negative steady state. The name comes from the waveform's similarity to a square.

**Step:** A step is one stage in a sequence and can be a control signal, single note, chord or rest.

**Stereo / Stereophonic:** The most common method of sound reproduction where separate channels, left and right, are used to give the impression of direction.

**Stereo-Field / Stereo Image:** A virtual space created by stereo loudspeakers/monitors.

**Sub-Bass:** Frequencies in a signal ranging from 10 Hz to 60 Hz (lower than C0 to approximately B1).

**Subtractive Synthesis:** A technique of creating sounds by filtering waveforms which are rich in harmonics.

**Sustain Level:** The third stage of an ADSR envelope. Specified as "the level an envelope will return to, after the decay stage". The envelope will remain at the sustain level until the played key is held.

**Sustain Pedal:** A Pedal containing a switch which can be connected to a sustain input and used to send a control signal dependant on the state of the switch (On/Off). The control signal can then be used to modulate other parameters, and/or to add expression.

**Synchronisation (Sync):** Coordination of timing between devices.

**Sync (Tempo):** A function where an cyclical event such as an LFO is synchronised to a tempo value.

**Sync (Oscillator):** A function where one oscillator is synchronised to another. The waveform of the slave oscillator is reset whenever the waveform of the master oscillator restarts.

**Sync (Arp/Seq):** A function where an arpeggiator or sequencer is synchronised to a tempo value.

**Sync (Key):** A function where an event is synchronised to the pressing of a key.

**System Exclusive (SysEx) Messages:** Multi-byte messages used to transfer a complete program or globals, in the form of request - response.

**Threshold:** Level at which dynamics processing will begin to operate.

**Tempo:** The speed at which a composition should be played, usually expressed in beats per minute (BPM).

**Threshold:** In dynamic effects, this is the level that must be passed before the processing is engaged.

**Timbre:** The tone, character, or aesthetic qualities of a sound.

**Transposition / Transpose:** A function that allows you to shift the entire keyboard up and down in pitch.

**Treble:** Frequencies in a signal ranging from 5 kHz to 20 kHz (approximately D#8 to above C10).

**Tremolo:** A periodic change in amplitude.

**Triggering:** Activation of a function, such as the start of a note, envelope, or LFO.

**Tune / Tuning:** The process of adjusting the root pitch of the instrument to a specific reference frequency.

**Unbalanced Audio:** A type of audio connection that uses two wires in a cable and does not offer the noise rejection qualities of a balanced system.

**Unison:** Two or more voices that are playing together at roughly the same pitch.

**Universal Serial Bus (USB):** A "plug and play" interface that provides a fast connection between a computer and peripherals.

**Volt (V):** A unit of electrical potential differential or electromotive force. A difference in charge between two points in a circuit. This difference, when combined with the rate of the charge (current) allows for the control of many analog circuits that "synthesise" sound.

**Voltage Controlled Amplifier (VCA):** An amplifier whose resultant magnitude is controlled by a voltage.

**Voltage Controlled Filter (VCF):** A filter whose cut-off frequency can be controlled by a voltage.

**Voltage Controlled Oscillator (VCO):** An oscillator whose cut-off frequency can be controlled by a voltage. Typically creates the possibility of tuning drift when used in a synthesizer.

**Vibrato:** A periodic change in pitch.

**Voice:** A physical embodiment of a complete set of OSC, Envelopes, LFOs and VCF which can play a single note.

**Waveform:** A repeating signal typically created by an oscillator. A waveform can also be random in the case of noise.

**Wavelength:** The shortest distance between two successive points on a wave that are in phase. When used in audio or acoustics, the physical wavelength is calculated by dividing the velocity of sound in air (approximately 340 m/s) by the waveform frequency.

# MODEL D Patch Sheet

# Patch Number

DATE:	AUTHOR:	TITLE:
NOTES:		

**MIDI**

MIDI IN

MIDI THRU

**CONTROLLERS**

OSC3 FILTER REG NOISE (MOD SRC) LFO

MOD DEPTH

GLIDE

OSC3/ FILTER REG NOISE/ LFO

MOD MIX

TUNE

OSCILLATOR MODULATION

**OSCILLATOR BANK**

MOD SOURCE

OSC 1/4/OCT

LFO CV

OSCILLATOR-1 FREQUENCY

OSCILLATOR-2

OSCILLATOR-3

OSC3 CONTROL

**MIXER**

LFO A

LFO FL

MIX

EXT

AUDIO

OVERLOAD

EXTIN VOLUME

NOISE VOLUME

WHITE

PINK

VOLUME

VOLUME

VOLUME

**MODIFIERS**

CUT OFF FREQ

FC GATE

FILT CONT

LC GATE

LOUD CONT

FILTER MODE

LO FILTER ON

HI MODULATION

KEYBOARD CONTROL

ATTACK

DECAY

SUSTAIN

LOUDNESS

ATTACK

DECAY

SUSTAIN

LOUDNESS

ATTACK

DECAY

SUSTAIN

**OUTPUT**

LOUD CV

MAIN

AUDIO

MAIN OUT

VOLUME

POWER

A-440 (VOICE) ON

PHONES

VOLUME







# FEDERAL COMMUNICATIONS COMMISSION COMPLIANCE INFORMATION



Responsible Party Name: **MUSIC Tribe Commercial NV Inc.**

Address: **5270 Procyon Street  
Las Vegas, NV 89118  
USA**

Phone Number: **+1 702 800 8290**

## MODEL D

complies with the FCC rules as mentioned in the following paragraph:

This equipment has been tested and found to comply with the limits for a Class B digital device, pursuant to part 15 of the FCC Rules. These limits are designed to provide reasonable protection against harmful interference in a residential installation. This equipment generates, uses and can radiate radio frequency energy and, if not installed and used in accordance with the instructions, may cause harmful interference to radio communications. However, there is no guarantee that interference will not occur in a particular installation. If this equipment does cause harmful interference to radio or television reception, which can be determined by turning the equipment off and on, the user is encouraged to try to correct the interference by one or more of the following measures:

- Reorient or relocate the receiving antenna.
- Increase the separation between the equipment and receiver.
- Connect the equipment into an outlet on a circuit different from that to which the receiver is connected.
- Consult the dealer or an experienced radio/TV technician for help.

This device complies with Part 15 of the FCC rules. Operation is subject to the following two conditions:

- (1) this device may not cause harmful interference, and
- (2) this device must accept any interference received, including interference that may cause undesired operation.

### Important information:

Changes or modifications to the equipment not expressly approved by MUSIC Group can void the user's authority to use the equipment.



We Hear You