

AVIOM[®]

64160

Output Module

User Guide

Certifications

ETL/cETL Listed

EMC: EN 55013, EN 55020, SAA AS/NZS 1053

Conforms to: IEC 60065, EN 60065, UL 6500-2001

Certified to: CAN/CSA E60065, KETI

RoHS Status: Pb-free



Notice of Rights

All rights reserved. No part of this document may be reproduced or transmitted in any form or by any means—electronic, mechanical, photocopy, recording, or otherwise—without written permission of Aviom, Inc.

Trademarks

Aviom, A-Net, the A-Net icon, Pro16, Pro64, and Virtual Data Cable are trademarks of Aviom, Inc.

All other trademarks are the property of their respective owners.

© 2009 Aviom, Inc. All rights reserved.

Information subject to change without notice.



READ THIS FIRST

Important Safety Instructions



1. Read these instructions.
2. Keep these instructions
3. Heed all warnings.
4. Follow all instructions.
5. Do not use this apparatus near water.
6. Clean only with a dry cloth.
7. Do not block any ventilation openings. Install in accordance with the manufacturer's instructions.
8. Do not install near any heat sources such as radiators, heat registers, stoves, or other apparatus (including amplifiers) that produce heat.
9. Do not defeat the safety purpose of the polarized or grounding-type plug. A polarized plug has two blades with one wider than the other. A grounding type plug has two blades and a third grounding prong. The wide blade or third prong are provided for your safety. If the provided plug does not fit your outlet, consult an electrician for replacement of the obsolete outlet.
10. Protect the power cord from being walked on or pinched, particularly at plugs, convenience receptacles, and the point where they exit the apparatus.



11. Only use attachments/accessories specified by the manufacturer.
12. Use only with the cart, stand, tripod, bracket, or table specified by the manufacturer, or sold with the apparatus. When a cart is used, use caution when moving the cart/apparatus combination to avoid injury from tip-over.
13. Unplug this apparatus during lightning storms or when unused for long periods of time.
14. Refer all servicing to qualified personnel. Servicing is required when the apparatus has been damaged in any way, such as when the power-supply cord or plug is damaged, liquid has been spilled or objects have fallen into the apparatus, the apparatus has been exposed to rain or moisture, does not operate normally, or has been dropped.
15. No on/off power switches are included in the system. The external power supply should be used to control power to an Aviom device. This power supply should remain readily operable.
16. The solid line over dashed line symbol () indicates that the input voltage must be a DC voltage.
17. The box within a box symbol () indicates that the external power supply is double insulated.



WARNING!



TO REDUCE THE DANGER OF ELECTRICAL SHOCK DO NOT REMOVE COVERS.

NO USER SERVICEABLE PARTS INSIDE

REFER SERVICING TO QUALIFIED SERVICE PERSONNEL ONLY

To reduce the risk of fire or electrical shock, do not expose this product to rain or other types of moisture.

To avoid the hazard of electrical shock, do not handle the power cord with wet hands.

Replace fuse with same type and rating.

Operating Temperature: 10°C to 50°C (50°F to 122°F)

Risque de choc électrique – ne pas ouvrir. Pour réduire le risque de feu ou de choc électrique, ne pas exposer cet équipement à la pluie ou la moisissure. Pour réduire le risque de choc électrique, ne pas retirer le couvercle. Pièces non remplaçables par l'utilisateur. Confier la réparation à une personne qualifiée. Attention – utiliser seulement un fusible de rechange de même type.

Cet appareil est conforme à la section 15 de la norme FCC. Son fonctionnement est soumis aux conditions suivantes : (1) cet équipement ne doit pas causer des interférences nocives, et (2) cet équipement doit accepter toute interférence captée incluant les interférences pouvant causer des opérations indésirables.

Cet appareil numérique de Classe B est conforme à la norme NMB-003 du Canada.

CAUTION:

- Using any audio system at high volume levels can cause permanent damage to your hearing.
- Set your system volume as low as possible.
- Avoid prolonged exposure to excessive sound pressure levels.

IMPORTANT:

This equipment has been tested and found to comply with the limits for a Class B digital device, pursuant to part 15 of the FCC Rules. These limits are designed to provide reasonable protection against harmful interference in a residential installation. This equipment generates, uses and can radiate radio frequency energy and, if not installed and used in accordance with the instructions, may cause harmful interference to radio communications. However, there is no guarantee that interference will not occur in a particular installation. If this equipment does cause harmful interference to radio or television reception, which can be determined by turning the equipment off and on, the user is encouraged to try to correct the interference by one or more of the following measures:

- Reorient or relocate the receiving antenna.
- Increase the separation between the equipment and receiver.
- Connect the equipment into an outlet on a circuit different from that to which the receiver is connected.
- Consult the dealer or an experienced radio/TV technician for help.

Changes or modifications to the product not expressly approved by Aviom, Inc. could void the user's FCC authority to operate the equipment.

Aviom, Inc. Limited Warranty

Aviom, Inc. warrants this product against defects in materials and workmanship for a period of **one year** from the date of the original retail purchase.

This warranty does not apply if the equipment has been damaged due to misuse, abuse, accident, or problems with electrical power. The warranty also does not apply if the product has been modified in any way, or if the product serial number has been damaged, modified, or removed.

If a defect is discovered, first write or call Aviom, Inc. to obtain a Return Authorization number. No service will be performed on any product returned without prior authorization. Aviom, Inc. will, at its option, repair or replace the product at no charge to you. The product must be returned during the warranty period, with transportation charges prepaid to Aviom, Inc., 1157 Phoenixville Pike, Suite 201, West Chester, PA 19380. You must use the product's original packing materials for shipment. Shipments should be insured for the value of the product. Include your name, address, phone number, description of the problem, and copy of the original bill of sale with the shipment. The Return Authorization number should be written on the outside of the box.

THIS LIMITED WARRANTY GIVES YOU SPECIFIC LEGAL RIGHTS. YOU MAY HAVE OTHER RIGHTS, WHICH VARY FROM STATE TO STATE (OR JURISDICTION TO JURISDICTION). AVIOM'S RESPONSIBILITY FOR MALFUNCTIONS AND DEFECTS IN HARDWARE IS LIMITED TO REPAIR AND REPLACEMENT AS SET FORTH IN THIS LIMITED WARRANTY STATEMENT. ALL EXPRESS AND IMPLIED WARRANTIES FOR THE PRODUCT, INCLUDING BUT NOT LIMITED TO ANY IMPLIED WARRANTIES OF MERCHANTABILITY AND FITNESS FOR A PARTICULAR PURPOSE, ARE LIMITED IN DURATION TO THE WARRANTY PERIOD SET FORTH ABOVE. NO WARRANTIES, WHETHER EXPRESS OR IMPLIED, WILL APPLY AFTER SUCH PERIOD.

AVIOM, INC. DOES NOT ACCEPT LIABILITY BEYOND THE REMEDIES SET FORTH IN THIS LIMITED WARRANTY DOCUMENT. AVIOM, INC.'S LIABILITY IS LIMITED TO THE REPAIR OR REPLACEMENT, AT OUR OPTION, OF ANY DEFECTIVE PRODUCT, AND SHALL IN NO EVENT INCLUDE INCIDENTAL OR CONSEQUENTIAL DAMAGES OF ANY KIND.

SOME STATES DO NOT ALLOW EXCLUSIONS OR LIMITATION OF IMPLIED WARRANTIES OR LIABILITY FOR INCIDENTAL OR CONSEQUENTIAL DAMAGES, SO THE ABOVE LIMITATIONS MAY NOT APPLY TO YOU.

Warranty Information

Please record the following information for future reference:

Your Authorized Aviom Dealer:

Name: _____

Address: _____

Phone: _____

Serial Numbers of Your Aviom Products: _____

Date of Purchase: _____

Your Authorized Aviom Dealer is your primary source for service and support. The information recorded above will be helpful in communicating with your Authorized Aviom Dealer should you need to contact Aviom Customer Service. If you have any questions concerning the use of this unit, please contact your Authorized Aviom Dealer first. For additional technical support, or to find the name of the nearest Authorized Aviom Repair Station, check the Aviom web site at www.aviom.com.

To fulfill warranty requirements, your Aviom product should be serviced only at an authorized Aviom service center. The Aviom serial number label must appear on the outside of the unit, or the Aviom warranty is void.

This manual and its contents are copyrighted by Aviom, Inc. All rights are reserved by Aviom, Inc. This document may not, in whole or in part, be copied, photocopied, reproduced, translated, or reduced to any electronic medium or machine-readable form without prior written consent from Aviom, Inc.

The software and/or firmware contained within Aviom products is copyrighted and all rights are reserved by Aviom, Inc.

Although every effort has been made to ensure the accuracy of the text and illustrations in this manual, no guarantee is made or implied as to the accuracy of the information contained within.

Table of Contents

Welcome	1
Features	1
The EtherCon Connector	1
About A-Net	2
Clocking	2
Control Data	3
A-Net Ports	3
Support For Pro16 Series Products	4
Firmware Notice	5
AC Power	6
AC Line Conditioning	6
Rack Mounting	6
Ventilation	7
Cleaning	7
Pro64 Interface Conventions	8
Cat-5e	8
Button Presses	8
Changing Values	8
Selecting Values	9
DIP Switches	9
Pro64 User Interface	10
Basic Actions	10
A-Net Slot	11
Slots versus Channels	11
Slots and Sample Rate	12
A-Net Slot Display	13
A-Net Slot Example	15
Network Modes	17
Auto Mode	17
Manual Mode	17
Front Panel Components	19
Rear Panel Components	21
Front Panel Features	24
Enter/Cancel Buttons	24
A-Net LED	24
Control Master	24
Control Master Errors	25
A-Net Slot Configuration	26
Setting the A-Net Slot Range	26
A-Net Receive	27
Changing the A-Net Receive Port	27
Clock Master	28
Sample Rate	29
Changing the Sample Rate	29

Sample Rates and A-Net Slots	30
Channel Activation Button	30
Channel Activation Rules	31
Level Meter LEDs	31
Stereo Link LED	32
Output Level Switches	32
Managed Button	33
Edit Lock Button	33
Query Functions (Get Info)	34
VDC Configuration	35
VDC Slot Display	35
VDC In Use LED	36
Assigning a VDC Slot	37
Deactivate an Active VDC Slot	37
Advanced Functions	38
Function Button	38
Clear A-Net Resources	39
Password Lock	39
Password Unlock	39
Set a New Password	40
Sample Alignment	40
Get New Sample Alignment Lock Value	41
Use Stored Sample Alignment Lock Value	42
Use Default Sample Alignment Lock Value	42
Firmware Update	43
Firmware Update Connections	43
Firmware Update - Local	43
Error Recovery	44
Firmware Update - via A-Net	44
Restore Factory Defaults	45
Control Master	47
Setting Control Master Status	48
Control Master Functions	48
Enumeration	48
Adding Pro64 Modules to a Network	49
Changing Settings	49
Control Master and Clock Source	50
Clock Errors	51
Network Sample Rate	51
Changing the Sample Rate	52
Auto/Manual Mode Selection	52
Changing the Network Mode	53
Managed Mode	53
Password Protection	54
Rear Panel Features	56
AC Power	56

Fuse	56
A-Net Ports	56
Balanced Line-Level Outputs	56
DB25 Alternate Audio Out	57
DB25 Pinout	57
Virtual Data Cable Ports	58
GPIO	58
GPIO Configuration DIP Switches	58
GPIO Terminal Blocks	59
MIDI In, MIDI Out	59
Configuring a MIDI VDC	59
RS-232 Port	60
RS-232 Configuration DIP Switches	61
RS-232 Baud Rates	61
Building a Pro64 Network	63
Choosing a Network Mode	63
Connecting Pro64 Modules	63
Basic Routing	63
Auto Mode Connections	64
Digital Copies in Auto Mode	65
Adding a Merger Hub in Auto Mode	66
Manual Mode Connections	67
Digital Copies in Manual Mode	71
Specifications	74
Dimensions	76
6416o Block Diagram	77
GPIO Specifications	78
GPIO Plugs	79
MIDI/GPIO Cable Lengths	79
Factory Default Settings	79
Index	80
Warranty Registration	86

Welcome

Thank you for purchasing the **6416o Output Module**. The 6416o is available in two versions; the standard 6416o has a choice of two output levels and the 6416o v.2 has four. Both versions can be used with other Pro64 devices in any combination.

This User Guide is designed to familiarize you with the features and functions of your new Pro64® product. All Pro64 products are powered by A-Net®, Aviom's proprietary data transmission protocol designed especially for the unique demands of live streaming audio. In developing the Pro64 Series, we have made every effort to make the user interface as easy to use and understand as possible. We encourage you to read the manual completely, as some of the powerful features of your new product may not be immediately apparent.

Features

The 6416o Output Module provides a host of professional features designed to make audio networking with Pro64 Series products easy to set up and configure in a variety of professional audio situations.

6416o Output Module Features:

- Sixteen line-level analog audio outputs
- XLR output jacks
- DB25 Alternate Output connections
- Individual activation buttons per channel
- Two A-Net® ports
- EtherCon® RJ45 network connectors

The EtherCon Connector

Pro64 Series products feature locking connectors for all network I/O. The Neutrik® EtherCon connector is a dual RJ45-type connector that can receive a standard Category 5e cable or a cable fitted with the special locking EtherCon connector.

When using a standard Cat-5e cable, plug the cable into the center of the EtherCon jack; release the cable by pressing on the small plastic tab built into the cable connector.

The locking EtherCon connector is similar to an XLR plug, the kind commonly used on microphone cables. Insert an EtherCon-equipped cable into the jack until it clicks and locks in place. To remove the cable, press on the metal release tab at the top of the panel-mounted EtherCon jack and pull the connector outward.

About A-Net



Aviom's A-Net® is the only networking technology conceived, designed, and optimized for managing and distributing audio using ordinary Cat-5e cables. As implemented in the Pro64® Series products, A-Net can transmit up to 128 channels of uncompressed 24-bit audio with the reliability and fidelity of analog, and the power and flexibility of a true digital network.

Pro64 A-Net allows variable sample rates in three ranges, from 44.1kHz± to 192kHz±, with ultra-low latency, jitter, and wander. Pro64 devices can be connected in any combination of serial (daisy-chain) or parallel (star) topologies. Cable runs between Pro64 devices can be up to 400 feet (120 meters) on Cat-5e¹, and miles on single- or multi-mode fiber optics (using Aviom fiber-capable equipment such as the MH10f).

Because A-Net is designed specifically for audio, the technological limitations of Ethernet and Ethernet-based products are removed, while audio performance and system flexibility are increased. A-Net incorporates Aviom's unique patented and patent-pending algorithms for controlling clock jitter and wander, as well as system-wide latency—regardless of an installation's size, design, or clocking setup. A-Net offers significant advantages in fidelity, performance, and flexibility over Ethernet-based products.

A-Net uses the "physical" layer of Ethernet, but it eliminates all the protocol elements that are designed for computers and IT-style networking. In audio applications, these other layers reduce efficiency, impose system restrictions, and introduce latency and timing instability. By eliminating Ethernet data structures, A-Net creates a superior network, with enhanced audio performance. With A-Net and the Pro64 Series, Aviom continues to break new ground in the design and development of innovative digital audio networking technologies and solutions.

Pro64 Series Supported Sample Rates		
Sample Rate	Minimum	Maximum
1x 44.1/48kHz	39.7kHz	52kHz
2x 88.2/96kHz	79.4kHz	104kHz
4x 176.4/192kHz	158.8kHz	208kHz

Clocking

The Pro64 network offers the most flexible clocking and synchronization options in the industry. Pro64 devices support three ranges of variable sample rates, from 44.1/48kHz± to 192kHz±. Because no sample rate converters are

1 Cat-5e, Cat-6, or better, Unshielded Twisted Pair (UTP) cable

used, audio transmission is kept fast and clean, eliminating the audio artifacts and signal degradation inherent to sample rate conversion—even when syncing to an external clock source.

Any Pro64 I/O module can be designated the clock master for the network, generating and distributing its internal clock. Digital I/O modules are capable of syncing to and distributing an external word clock.

Control Data

The Pro64 Series has built-in, dedicated bandwidth for 14 channels of non-audio control data through the use of Aviom’s innovative Virtual Data Cables™ (VDC). These data streams are always available to carry MIDI, RS-232/RS-422, or GPIO (General Purpose I/O), and they never compete with the audio channels for network resources, regardless of the system configuration.

Because VDC inputs are simply incorporated into the A-Net stream, these control signals can be transmitted over very long cable runs and even across an entire Pro64 network, significantly expanding the applications possible with MIDI, RS-232/RS-422, and GPIO. And as with audio signals, VDC control data can be input anywhere and output anywhere else in the network.

The exact complement of VDC I/O connectivity varies per product.

A-Net Ports

Pro64 I/O modules have dual A-Net ports, labeled A and B. Both ports carry a bidirectional A-Net stream at all times. (That is, both ports are always transmitting *and* receiving A-Net data.) Pro64 networks can be configured in one of two operational modes, Auto Mode or Manual Mode, depending on the requirements of a particular application.

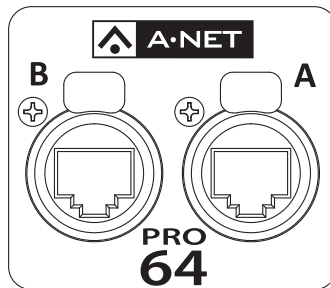

Each A-Net port carries bidirectional data at all times.

In Auto Mode, there are no connection rules; connect a Cat-5e cable to either the A or B port and the network does the rest. Auto Mode provides a true audio network with 64 available “Slots” for transporting audio (at 44.1/48kHz). Every audio Slot is available everywhere in the network, with no upstream/downstream restrictions.

In Manual Mode, the Pro64 network becomes a 64x64 system (at 48kHz), similar to a traditional stage-to-FOH snake. At every point in the Manual Mode network, two 64-channel streams are available on the cable and in each module. The configuration of the cables and ports has an impact on the makeup of the network and the distribution of audio signals. The user can direct A-Net data from a Pro64 input module to a specific port (A, B, or both). Likewise, Pro64 output modules can be configured to output audio signals received from a specific Pro64 network port (A or B).

Support For Pro16 Series Products

Pro64 Series products can be combined with Pro16® Series output products such as the Pro16 Monitor Mixing System by adding the Pro64 ASI A-Net Systems Interface. This 1U module converts Pro64 data to Pro16 data, providing up to four 16-channel streams of data (depending on the Pro64 sample rate) that can be used with A-16II and A-16R Personal Mixers, A-Net Distributors, and AN-16/o Output Modules.

**PRO
16[®]
SERIES**

The ASI is not compatible with the A-Net output of Pro16 input modules such as the AN-16/i and AN-16/i-M and console interface cards such as the Y1.

Firmware Notice

All Pro64 devices in a network should be updated to use the most recent firmware version to ensure trouble-free operation.

As new Pro64 modules are released, older Pro64 products need to be updated so that they recognize the features and functions of the newer modules—something that is especially important if one of the older devices will be used as the network’s Control Master. (If for some reason you cannot update the firmware on older Pro64 devices before using them, set the newest module to be the network Control Master.)

Pro64 Update Tool is a free Windows software application for updating the operating firmware in Pro64 Series products.

The Pro64 Update Tool requires a direct RS-232 (serial) connection between the computer and the Control Master device on the Pro64 network. Normally this is accomplished by connecting a null modem DB9 cable between the RS-232 jack on the computer and the Pro64 device. Complete information on using RS-232 (and USB-to-RS-232 adapters) is available on the Aviom website. Updates take just a few minutes per module.

Pro64 Update Tool is designed to run on a PC under Microsoft® Windows® XP. It has also been tested and found to be compatible with Microsoft Windows Vista®. Mac users can run Pro64 Update Tool using Windows XP running under Apple’s Boot Camp program on Intel-based Macs.

Get the Pro64 Update Tool and firmware update files from the Aviom website: <http://www.aviom.com>

AC Power

Always plug the unit into a properly grounded (earthed) outlet. Always use the AC line cord that was shipped with the unit. Grasp the power cable by the connector and never by the cord itself when connecting and disconnecting it from the power source.

Do not expose the Pro64 device to moisture, rain, or excessively damp environments.

AC Line Conditioning

Aviom products are digital devices and as such are sensitive to sudden spikes and drops in the AC line voltage. Changes in the line voltage from lightning, power outages, etc., can sometimes damage electronic equipment.

To minimize the chance of damage to your equipment from sudden changes in the AC line voltage, you may want to plug your equipment into a power source that has surge and spike protection. Power outlet strips are available with built-in surge protection circuits that may help protect your equipment.

Other options for protection of your equipment include the use of an AC line conditioner or a battery backup system (sometimes referred to as an *uninterruptible power supply*, or UPS).

Rack Mounting

Pro64 products are designed to be mounted in a 19-inch equipment rack. The rack ears on each side of the device are designed to support the weight of the product without additional hardware. Each rack ear contains holes for two screws per side. Always support the unit with all four screws to avoid damage to the unit.

To rack mount the Pro64 product, position it in the equipment rack at the desired location. Use standard rack-mounting screws (10-32 size) to attach the unit to your rack hardware. Tighten all four screws firmly, but avoid overtightening.

Aviom suggests the use of non-metallic washers between the rack-mounting screws and the device's finished surface to avoid marring the finish on your Aviom products.

Ventilation

Always allow adequate ventilation for devices mounted in equipment racks. Avoid placing your Pro64 product directly above or below other rack-mounted devices that produce high levels of heat, such as power amplifiers.

Cleaning

Before cleaning a Pro64 product, turn off the power switch and unplug the unit from the AC power source.

To clean the surface of the Pro64 product use a clean, soft lint-free cloth that has been slightly moistened with water only. For tougher dirt, use a cloth slightly dampened with water or with a mild detergent. Always be sure to dry the surface of the unit before proceeding with use.

When cleaning your Aviom products, never spray cleaners directly onto the product surfaces. Instead, spray a small amount of the cleaning solution onto a clean cloth first. Then use the dampened cloth to clean the product.

Never use solvents or abrasive cleaners on the finished surfaces of your Aviom products.

Pro64 Interface Conventions

Many Pro64 Series products have similar user interface components, including buttons, LEDs, and switches. When describing the features and functions of Pro64 Series products, the following conventions will be used.

Cat-5e

All Cat-5e connections between A-Net devices should use Unshielded Twisted Pair (UTP) cable. The cable can be of the stranded or solid type; solid wire performs better over long distances, while stranded wire is more flexible and easier to manipulate and therefore easier to work with in a performance situation.

Cables designated as Cat-5e in Pro64 documentation can be interchanged with any Cat-6 (or better) cable. Cables will be referred to simply as "Cat-5e."

Connectors on Cat-5e cables can be of the standard RJ45 variety or locking Neutrik EtherCon type.

Button Presses

When referring to specific front-panel labels, LEDs, and buttons or when describing a Pro64 function that requires the press of a button on the front panel of a device, a special typeface will be used. For example, "Press the **ENTER** button to confirm the sample rate change."

Buttons that work in combination, giving the user a choice when performing an operation, will be referred to as one unit. For example, "Changing the sample rate requires the user to confirm the change using the Enter/Cancel buttons."

Changing Values

When editing values on the front panel of a Pro64 device, some operations will require the use of the inc/dec (short for increment/decrement) buttons. These buttons scroll up and down through a list of available values. Holding the button down does not accelerate scrolling. The front panel of a Pro64 module is marked only with indicator arrows. (See the drawing on the following page.)

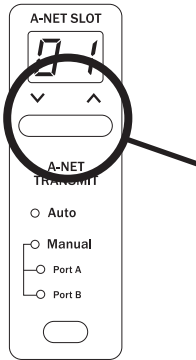

The buttons with up/down indicator arrows are used for the inc/dec functions.

Buttons of this type will be referred to as “inc/dec” buttons.

Selecting Values

Some settings, including Sample Rate, network mode (Auto or Manual), and Virtual Data Cable type, require the user to select from a range of values. The button that controls the selection of a value is referred to generically as the “selection button” for that function. For example, “Use the Sample Rate selection button to scroll through the available rates.”

Pressing a selection button repeatedly will scroll through the available settings and will wrap around when the end of the list is reached.

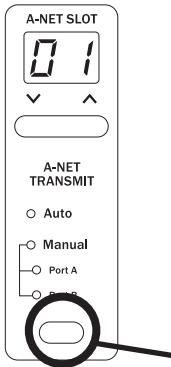

Pressing the selection button will cycle through the available values.

DIP Switches

Illustrations of Pro64 DIP switch components indicate the switch handles in black as seen below.



Pro64 User Interface

This section outlines some basic concepts of operation for Pro64 products. Pro64 I/O devices have some common user interface elements that make setting up a digital snake or audio network easy to understand.

Common elements include:

- Enter button
- Cancel button
- A-Net Slot selection
- Network Mode (Auto/Manual)
- Sample Rate display
- Managed button
- Edit Lock button
- Virtual Data Cable (VDC) configuration

In addition, each I/O module has the ability to be set as the Control Master and/or Clock Master (depending on the actual makeup of the analog/digital modules in the audio network). Only one device can have control of these functions at a time in a properly configured Pro64 network.

Basic Actions

Most system-level operations in the Pro64 user interface require the use of the Enter button to confirm an action. For example, assigning a Virtual Data Cable port to a VDC Slot or choosing a new sample rate (on the Clock Master device only) will require the user to press the **ENTER** button to confirm the request. If no press of the Enter button is detected within a predetermined time frame, the system will automatically cancel the request and return the device (or entire network) to the previous state.

Operations that do not require the use of the Enter/Cancel buttons include:

- Stereo channel link (input modules)
- Channel activation (input modules)
- Channel on/off (output modules)
- Gain settings (input modules)
- Output level settings (output modules)

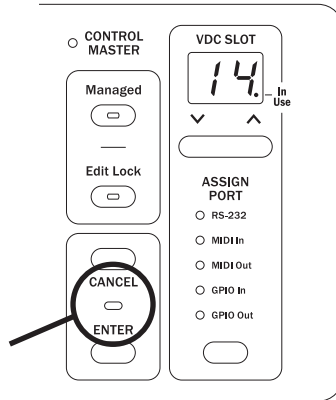

The LED between the Enter and Cancel buttons flashes when a button press is required to continue.

Any operation that requires the use of the Enter/Cancel buttons will flash the LED that is located between the two buttons to indicate that a button press is required to complete the action. To confirm an operation, press **ENTER**. To exit an operation without completing it, press the **CANCEL** button.

A-Net Slot

Pro64 I/O devices come in a variety of configurations; to allow a large number of hardware audio input devices to be available to the Pro64 audio network, Aviom has implemented the concept of the A-Net Slot to simplify the configuration of potentially complex audio networks.

A Pro64 audio network will always have a finite number of A-Net Slots available that can be addressed by an unlimited number of hardware channels. The actual number of available Slots is determined by the current sample rate.

Slots versus Channels

You might be wondering why Aviom chose to refer to the audio I/O resources in the Pro64 Series products as “Slots.” Why not just call them “channels”?

We did this to avoid confusion between references to *hardware* audio resources and *network* audio resources. The word “channel” is ambiguous and may cause confusion when configuring an audio network. “Channel” appears in many contexts, including audio mixing consoles, mic preamps,

DSP processors, and DAW software.

We use the word “channel” when referring to the *physical* audio inputs— analog or digital—on a piece of hardware (such as the 16 line-level XLR input jacks on the 6416i Input Module). Each of these audio inputs can be made active and added to the network individually, and it is only when *activated* that they use any network resources (the A-Net Slots). To allow this functionality, Pro64 products separate the hardware resources from the available network resources by giving each hardware input channel a button that allows it to be added to the network as needed.

It is these activated hardware resources that are being referred to as “Slots.” Pro64 audio networks can potentially have a greater number of audio channels and hardware I/O devices connected than the network can make use of at one time. This provides flexibility without requiring constant re-patching.

Keep in mind that a Pro64 A-Net network can only manage a specific number of Slots at a time, and this number varies with the sample rate being used. The maximums are 64 Slots in Auto Mode at the 48kHz sampling rate and 64x64 Slots in Manual Mode at 48kHz.

In summary, think of “channels” as hardware resources that can be added to the network as needed and “Slots” as locations within the digital audio network pipeline that A-Net uses to move data throughout the network.

Slots and Sample Rate

The current system-wide sample rate will determine the number of A-Net Slots that are available. Auto Mode and Manual Mode have the same number of Slots at each sample rate; only the direction of the data is different.

Sample Rate	A-Net Slots
44.1kHz	64
48kHz	64
88.2kHz	32
96kHz	32
176.4kHz	16
192kHz	16

Even though the network sample rate may change the available number of A-Net Slots, the capacity of a hardware device does not change. That is, a 16-channel input module in a 192kHz network can still have all of its channels activated; all of its physical inputs can operate at 192kHz.

The current sample rate will also affect the display of available A-Net Slot ranges. Slot ranges will always have the same maximum number as seen in the sample rate chart. At 96kHz, for example, only Slots numbered 1 through

32 are available; the Slot range from 33 to 64 is inactive and unavailable at that sample rate. Slot ranges outside the maximum for the current sample rate can be selected, but attempting to activate a channel in an unavailable range will result in an error message (the selected channel button, A-Net Slot range, and sample rate LEDs will all flash).

A-Net Slot Display

Since the capacity of the Pro64 network could be as high as 64 A-Net Slots, Pro64 hardware I/O devices need a way of routing a selected hardware channel to a selected network Slot. In the upper left corner of the front panel of a Pro64 I/O device, the A-Net Slot display and its associated inc/dec buttons are used to select a range of Slots that the hardware device will address.

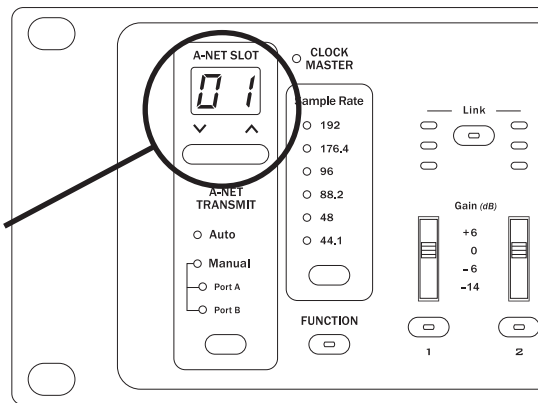

The A-Net Slot display and its inc/dec buttons are used to set the base Slot for a Pro64 I/O module.

The A-Net Slot display will show the base number that is associated with the first hardware input or output channel on an I/O device. The actual number seen in this display will be determined by the physical I/O on the device. That is, an 8-channel device will display a different set of available starting points than a 16-channel device (see the following tables).

To select an A-Net Slot range, use the inc/dec buttons below the display. Press one of the buttons until the desired base Slot range is displayed, and then press the **ENTER** button. To return to the current selection without making a change, press the **CANCEL** button.

The following tables show examples of the channel-to-Slot correlation for Pro64 Series modules in a network running at the 48kHz sample rate.

The numbers in the Slot column will appear in the A-Net Slot display. The numbers seen to the right of each gray base Slot number correspond to the channel buttons on the front panel of the interface.

<i>Pro64 Module Hardware Channels</i>																
	1	2	3	4	5	6	7	8	9	10	11	12	13	14	15	16
Base Slot	A-Net Slot															
1	1	2	3	4	5	6	7	8	9	10	11	12	13	14	15	16
17	17	18	19	20	21	22	23	24	25	26	27	28	29	30	31	32
33	33	34	35	36	37	38	39	40	41	42	43	44	45	46	47	48
49	49	50	51	52	53	54	55	56	57	58	59	60	61	62	63	64

The use of Slot assignments allows for easy reconfiguration of audio networks and sharing of hardware I/O resources and data without physical re-patching.

A-Net Slot Example

The following example shows the power of the Pro64 network and the A-Net Slots concept.

The range of A-Net Slots used in the example has been limited to the group from 1 to 16 for simplicity.

This graphic represents a Pro64 product set to Slot range 1.

Slot	Channel															
1	1	2	3	4	5	6	7	8	9	10	11	12	13	14	15	16

One 16-channel input module is placed in each of four rooms of a production facility, designated as Studios A, B, C, and D. One 16-channel output module is installed in the facility's Studio E. All modules are set to Slot range 1.

<i>Studio A Inputs</i>																
Slot	Channel															
1	1	2	3	4	5	6	7	8	9	10	11	12	13	14	15	16

<i>Studio B Inputs</i>																
Slot	Channel															
1	1	2	3	4	5	6	7	8	9	10	11	12	13	14	15	16

<i>Studio C Inputs</i>																
Slot	Channel															
1	1	2	3	4	5	6	7	8	9	10	11	12	13	14	15	16

<i>Studio D Inputs</i>																
Slot	Channel															
1	1	2	3	4	5	6	7	8	9	10	11	12	13	14	15	16

<i>Studio E Outputs</i>																
Slot	Channel															
1	1	2	3	4	5	6	7	8	9	10	11	12	13	14	15	16

By activating a group of channels on each of the four input modules, a total of sixteen inputs are used (indicated by reverse text). All of these inputs are available on the network at every output module. The operator in Studio E can use the sixteen inputs from Studios A, B, C, and D simultaneously.

The order in which the Pro64 devices are connected is irrelevant.

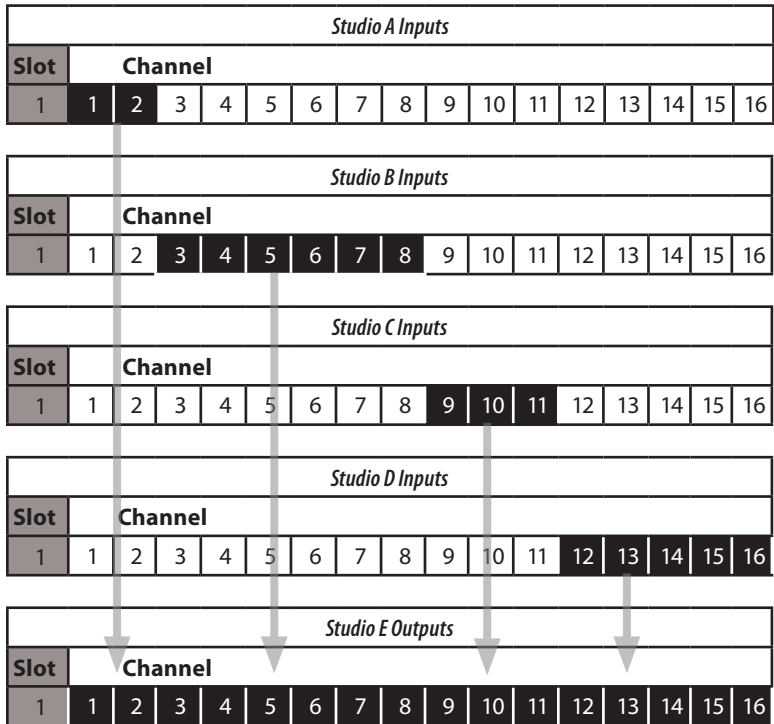

Network Modes

A Pro64 audio network can be set to operate in one of two modes, Auto or Manual. The network mode can be selected on the front panel of the device designated as the system's Control Master.

Both modes are fully bidirectional at all times, regardless of the system layout or design.

Auto Mode

Pro64's Auto Mode takes most of the work out of managing resources in an audio network. This is the "everything everywhere" mode. Channels are sent into the network and can be seen and used by all devices in the network, regardless of how the modules are connected and regardless of the physical location of any module. Output modules do not need to follow input modules as in a traditional analog system. In Auto Mode, both A-Net ports (A and B) function identically.

Once configured for Auto Mode, the system ensures that only one hardware input channel is activated into a given A-Net Slot. There is no limit to the number of hardware output channels that can use a given A-Net Slot. The actual number of available Slots is determined by the current sample rate. The maximum number is 64 active channels at the 44.1/48kHz sample rate.

Sample Rate	Available A-Net Slots in Auto Mode
44.1 / 48kHz	64
88.2 / 96kHz	32
176.4 / 192kHz	16

Manual Mode

When more than 64 channels are needed in a network, Manual Mode can be used to provide configurations of up to 64 x 64 channels. Two unique 64-channel streams are available at each module. In Manual Mode, the A and B A-Net port connections can be used to direct and route A-Net data.

Pro64 input modules can send their audio inputs to either or both A-Net ports, while output modules can listen to data from either port. For a traditional stage-to-FOH snake system, this allows the user to configure a system with up to 64 sends from the stage and another unique stream of up to 64 returns to the stage.

Manual Mode operation removes the restrictions of unique channel-to-Slot-range relationships found in Auto Mode. Slots can be overwritten, allowing the user to replace channels from one part of the network with new data.

This means that, while no more than 128 channels can be in the network at a particular location, there is no practical limit to the total number of audio channels in the system.

The number of available Slots in Manual Mode is dependent upon the current sample rate.

Sample Rate	Available A-Net Slots in Manual Mode
44.1 / 48kHz	64 x 64
88.2 / 96kHz	32 x 32
176.4 / 192kHz	16 x 16

Front Panel Components

6416o

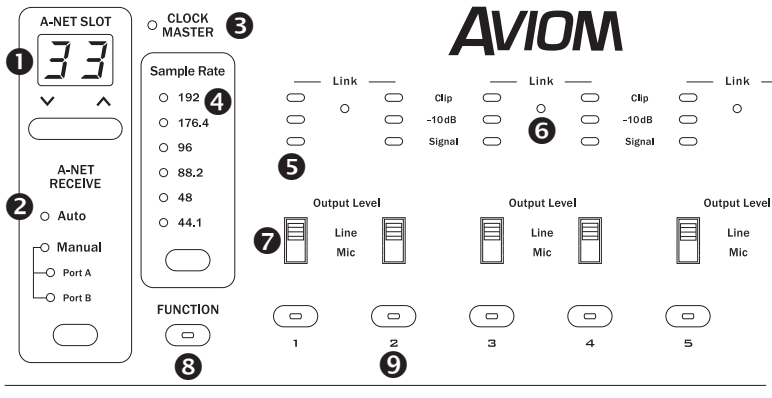

1. A-Net Slot Configuration
2. Auto/Manual Mode Selection
3. Sample Rate
4. Clock Master
5. Level Meter LEDs
6. Stereo Link LEDs
7. Output Level Switch
8. Function Button
9. Channel Activation Button

6416o v.2

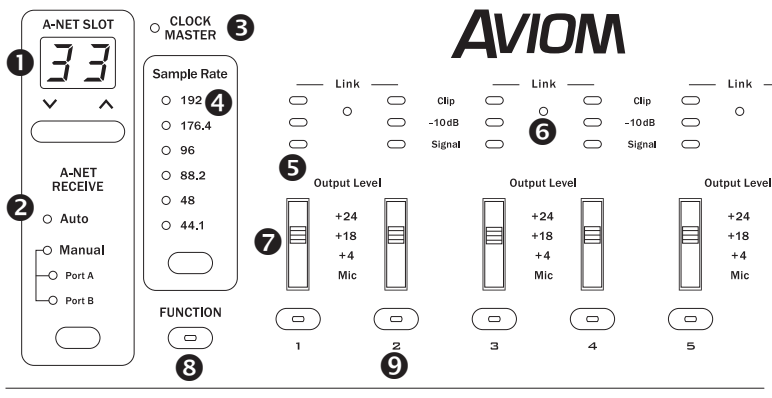

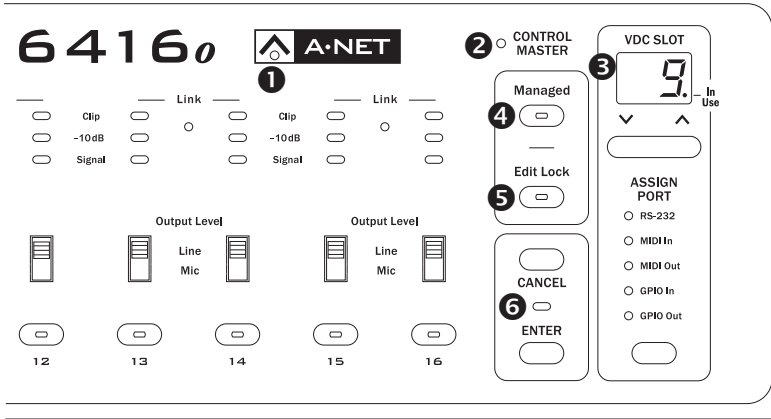

1. A-Net LED
2. Control Master LED
3. VDC Configuration
4. Managed Mode Button
5. Edit Lock Button
6. Enter/Cancel Buttons

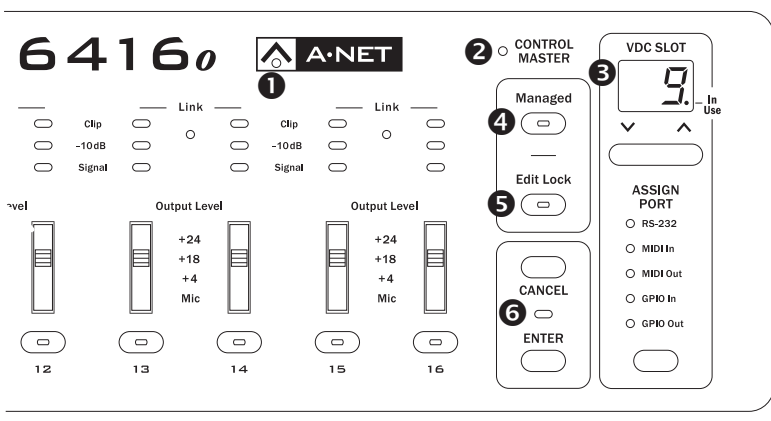

Rear Panel Components

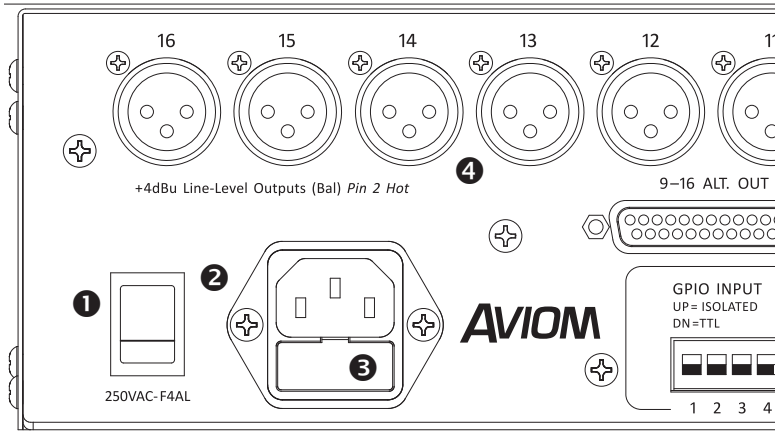

1. Power On/Off Switch
2. IEC Power Inlet
3. Fuse Holder
4. Balanced Line-Level Outputs, XLR

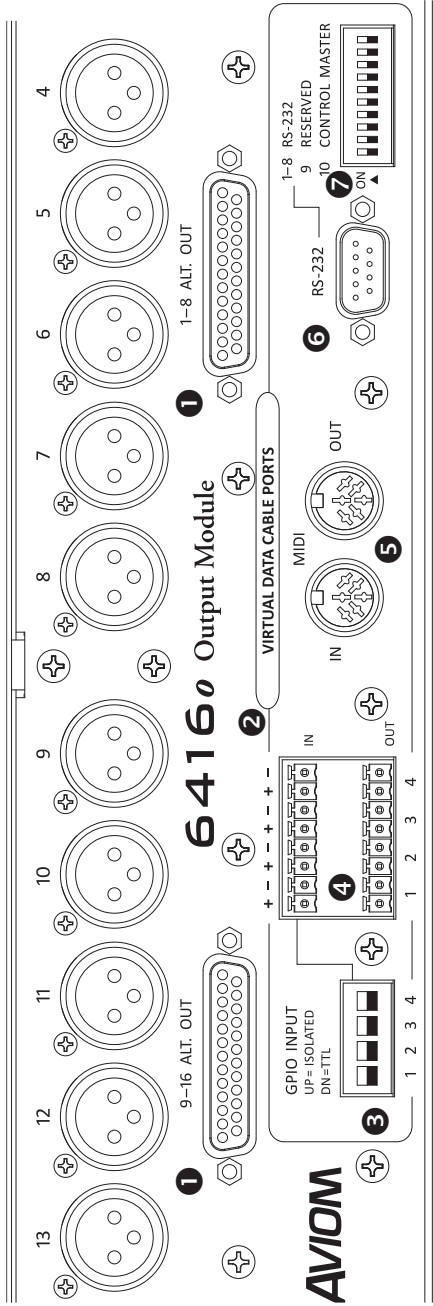

1. DB25 Alternate Audio Outputs, x2
2. Virtual Data Cable Ports
3. GPIO Configuration DIP Switches
4. GPIO Terminal Blocks
5. MIDI In, MIDI Out
6. RS-232 Port
7. RS-232 Configuration DIP Switches (1-8)

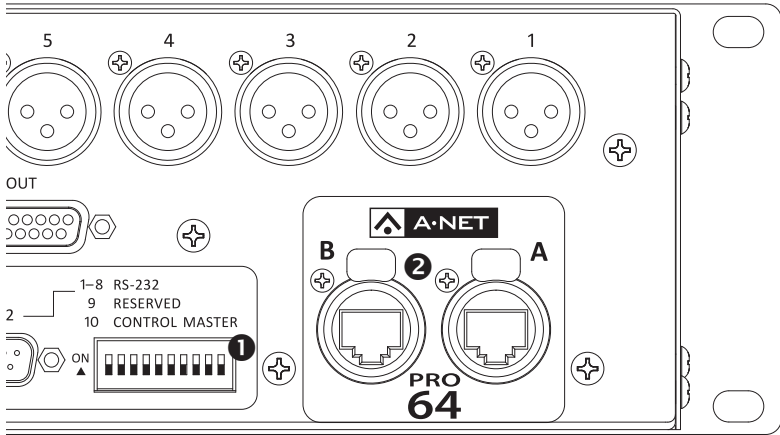

1. Control Master DIP Switch (#10)
2. A-Net Ports, EtherCon Jacks

Front Panel Features

This section describes the features and functions of all front-panel components of the 6416o Output Module. Other than the output level switches, most front panel features are common on the 6416o and 6416o v.2. Unless otherwise noted, all references to the 6416o apply to the 6416o v.2 as well. Either model can be used when creating Pro64 systems.

Enter/Cancel Buttons

The pair of buttons marked **ENTER** and **CANCEL** will be used to confirm functions and mode changes or to exit a change request. The LED between the two buttons will flash whenever the user is required to press one of these buttons in order to continue with an operation or edit.

A-Net LED

The blue LED found within the A-Net logo functions as the network activity indicator. When a module is powered up, its A-Net LED will flash while a request to enter the network is sent to and then processed by the device designated as Control Master. Once a module is enumerated and is part of the network, the blue A-Net LED will light solid. The LED will remain lit as long as valid A-Net network data is received.

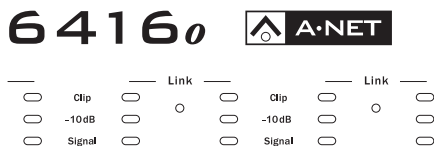

The A-Net LED lights blue when the 6416o is active on the network.

The A-Net LED will flash during an operating system upgrade when the module being updated is part of an active network. When a module is being bench configured (it is not part of an active network), the A-Net LED will be off during the firmware update. (Check the Aviom website for current firmware updates.)

Control Master

One Pro64 module in every network must be designated as the Control Master. To set the 6416o as the Control Master, one of the DIP switches on the rear panel in the VDC section is used. In the group of RS-232 DIP switches, switch #10 is used to designate a module as the Control Master. Set this

switch to the up position with the power off to avoid conflicts with network resources.

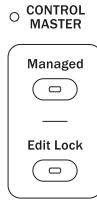

The Control Master LED lights red when a module is set to be the network's Control Master device.

When the Control Master module is powered up, the network will be enumerated and the blue A-Net LEDs on all Pro64 devices will be lit. On the Control Master device, its red Control Master LED will also be lit. The Control Master LED will be off on all remote/slave modules in a network.

Control Master Errors

The following rules apply to the Control Master and active Pro64 networks.

If a slave module in an active running network is incorrectly switched to be a Control Master (in addition to the network's already functioning Control Master) that module's Control Master LED will light and the A-Net LED will go out to indicate the error. The Control Master LED will remain lit until the module is returned to slave status. All other module functions will operate normally.

If a new powered module set to be the Control Master is added to an active running network (one that already has a valid Control Master), the new module's Control Master LED will light. Its audio resources will remain unavailable until the module is returned to slave status. All audio on this module will be muted until the module is set to be a slave.

If the Control Master is removed from a functioning network (by being disconnected, power failure, etc.), all slave units will reset and audio will be muted. Slave units will wait for a new Control Master to be designated and at that point will begin the enumeration process.

A-Net Slot Configuration

The A-Net Slot section of the interface is used to set the range of A-Net Slots from which the 6416o will draw its audio channels. There are two components: the A-Net Slot display and the inc/dec buttons used to select a value.

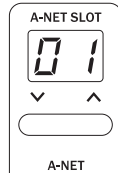

Press the up/down buttons to select an A-Net Slot range.

On a sixteen-channel module like the 6416o, the A-Net Slot display will move in increments of sixteen Slots. The A-Net Slot range display will wrap as it reaches the end of the list of available values. The number shown in the display corresponds to the first Slot in a group of sixteen sequential Slots, one per channel button. The available base Slots are 1, 17, 33, and 49.

Starting Slot Displayed	A-Net Slot Range
01	Slots 1-16
17	Slots 17-32
33	Slots 33-48
49	Slots 49-64

Keep in mind that the number of available Slots is determined by the current network sample rate as set by the Clock Master.

Setting the A-Net Slot Range

To set a Slot range, use the inc/dec selection buttons found below the A-Net Slot display to select the desired range. When the selection button is pressed, the new range displayed will start to blink, as will the Enter/Cancel button's LED. This indicates that confirmation is required to complete the change. Press **ENTER** to set a new range or press **CANCEL** to exit without changing the A-Net Slot range and return to the previous setting. If no press of the Enter/Cancel button is detected within a brief period of time, the interface will automatically cancel the range change request, returning to the previous state.

A-Net Receive

The A-Net Receive section displays information about the current network mode, which can be set to Auto or Manual only at the network's Control Master. When the Pro64 network is operating in Auto Mode, the red Auto LED will be lit, and no user settings are available on a per-module basis. It does not matter which rear-panel A-Net port (A or B) is used when connecting devices to the network.

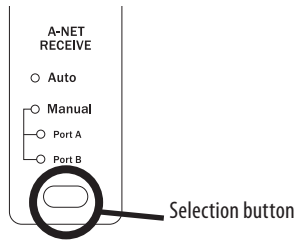

Only the Control Master can set the network mode to Auto or Manual.

In Manual Mode, the user has the option of using A-Net data from either A-Net port on the rear of the 6416o Output Module. Once the Control Master has set the network to operate in Manual Mode, the red Manual LED and at least one of the yellow Port LEDs will be lit on every Pro64 I/O module.

Two options are available:

- **PORT A** - the 6416o receives data from Port A on the rear panel
- **PORT B** - the 6416o receives data from Port B on the rear panel

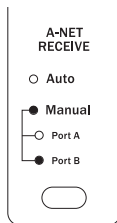

A-Net data will be received from Port B in Manual Mode in this example.

Changing the A-Net Receive Port

This applies to Manual Mode only; no user settings are available in Auto Mode. The VDCs are not affected by the network mode.

Use the selector button below the Auto/Manual Mode LED readout to cycle

between the options. When a new configuration is selected, the selected Port LED and the Enter/Cancel LED will blink; confirmation is required. Press **ENTER** to set a new receive port or press **CANCEL** to exit without making a change and return to the previous setting.

Changing the port receive settings in Manual Mode has no effect on the current channel on/off settings.

Clock Master

One device in a Pro64 network will always be set as the network's Clock Master. In a network with only analog I/O modules, the module set as the Control Master is also set to be the Clock Master by default. The Module set as the Clock Master will have its Clock Master LED lit.

When digital I/O modules are used in a network, incoming word clock or AES3 (also referred to as AES/EBU) digital data streams can also be clock sources. It is only when a digital module is part of the network that the Control Master and Clock Master can be separate devices.

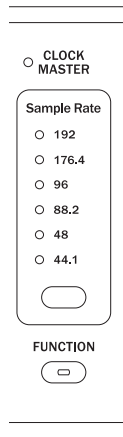

Only one Pro64 device can be set as the Clock Master. Its yellow LED will be lit.

Sample Rate

Pro64 networks can operate at sample rates in three ranges without the use of sample rate converters. The current network sample rate also determines the number of available A-Net Slots.

Sample Rate	A-Net Slots Available
1x 44.1/48kHz	64
2x 88.2/96kHz	32
4x 176.4/192kHz	16

In an all-analog network, the sample rate can be set at the Control Master to the following:

- 44.1kHz
- 48kHz
- 88.2kHz
- 96kHz
- 176.4kHz
- 192kHz

When an external clock is used with a Pro64 digital I/O device, the system can lock to any sample rate within a range that is $\pm 10\%$ of the currently displayed sample rate.

Pro64 Series Supported Sample Rates		
Sample Rate	Minimum	Maximum
1x 44.1/48kHz	39.7kHz	52kHz
2x 88.2/96kHz	79.4kHz	104kHz
4x 176.4/192kHz	158.8kHz	208kHz

Changing the Sample Rate

The network sample rate can be changed only at the Control Master. Changing the sample rate is done with the selection button found below the Sample Rate LED readout.

To choose a new sample rate, press the selection button beneath the sample rate list. Pressing the button selects the next sample rate in the list and immediately starts blinking the new rate's LED and the Enter/Cancel LED; confirmation is required. To confirm the new sample rate, press the **ENTER** button. To exit without changing the sample rate, press **CANCEL**.

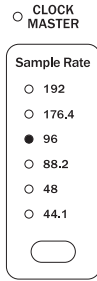

Pressing the selection button will cycle through the available sample rates.

Attempting to change the sample rate on a module that is not the Clock Master will cause the Sample Rate and Clock Master LEDs to flash to indicate the error.

Sample Rates and A-Net Slots

Changing the network sample rate has a direct effect on the availability of A-Net Slots. For example, setting the sample rate to 96kHz makes only 32 Slots available, numbers 1 through 32. Slot numbers 33-64 are no longer available.

If at the 48kHz sample rate a Pro64 device such as the line-level 6416i Input Module is set to the Slot range starting at 33 or 49 *and* has active channels, these channels will be deactivated when the sample rate changes to 96kHz. These Slot assignments no longer exist in the network.

Channel Activation Button

Each of the sixteen line-level output channels on the 6416o can be made active individually using the lighted Active button found below the 2- or 4-position output level switch on each channel. These buttons do not use network resources as a Pro64 input device does. They simply act as on/off switches for the signals passing to the 6416o rear-panel jacks from the D/A converters.

Any number of output modules can use the same set of channels simultaneously, providing a simple method for creating digital splits.

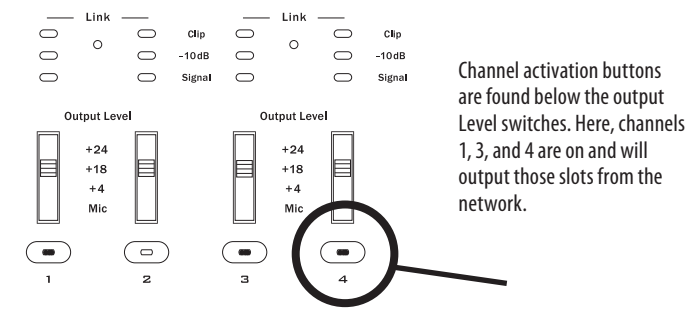

To activate a 64160 analog output within a given A-Net Slot range, press its numbered **ACTIVE** button. (Note that the word “Active” does not appear on the front panel user interface.) The channel’s yellow LED will light. Remember that these switches act as on/off switches on the 64160. If no audio is available on that Slot within the network, the LED will still light, but no audio will be heard.

Channel Activation Rules

It is not necessary to press the **ENTER** button to activate or deactivate a channel.

Each Pro64 module remembers a unique set of active channels for Auto and Manual Modes. For example, a module could have channels 1-8 active for an Auto Mode application and channels 5-6 and 12-16 active for a Manual Mode application. Changing network modes will restore the active channel status for each connected module.

Changing the A-Net Slot range will clear the currently active channels on the 64160 Output Module.

Level Meter LEDs

Each audio channel on the 64160 Output Module has its own set of level LEDs—green, yellow, and red. Green indicates signal present; it turns on when a signal level of -40dB or higher is present. The yellow LED lights when the signal level reaches -10dB. Clipping is indicated with the red LED, which lights when the level reaches 0dB.

The level meter LEDs on the 64160 will always show the level of the incoming network audio signal, even when the channel is not active on the front panel. Remember, the front panel activation switches on the 64160 are merely mute switches and do not affect the composition of the Pro64 network.

Stereo Link LED

Adjacent pairs of channels on Pro64 input modules can be linked together as a stereo pair. The channels must be an odd-even pair, such as 1-2, 7-8, etc.

Each pair of channels that are linked on an input module will light the matching channel Link LEDs on all 6416o Output Modules in the network.

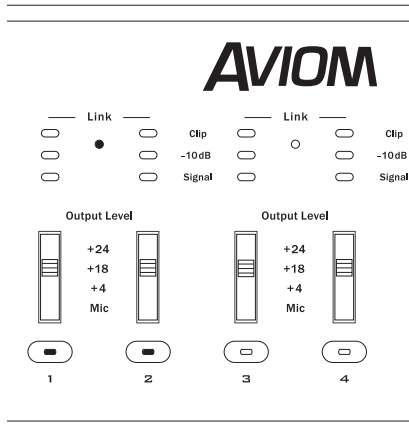

A pair of channels is indicated as being a stereo source. The left and right sides are shown as active in this example.

The left/right sides of the stereo pairs do not need to be activated together on a Pro64 output module. Each side can be muted or unmuted as needed.

Output Level Switches

Each line-level output channel on the 6416o has a two-position level switch that can be used to best match the analog signal level of the 6416o to the gear that it is connected to. The default setting is Line. The Mic setting adds a -40dB pad to the output, making the 6416o output level compatible with mic preamp or other sensitive inputs.

The 6416o v.2 has four-position output level switches; match the analog signal level of the 6416o v.2 to the input sensitivity of the gear that it is connected to by selecting the one of the three line-level outputs (+4dBu, +18dBu, or +24dBu) or use the Mic setting when connecting to mic preamp inputs.

The level switches on both versions of the 6416o are in the analog domain and are not locked out from being changed when either the Edit Lock or Password protection features are used.

Managed Button

The Managed button is used to put the network under control of a computer for firmware updates, system monitoring, etc. Managed Mode can only be engaged from the network's Control Master.

When using a PC for firmware updates, etc., a Pro64 module cannot have its RS-232 or MIDI port assigned to a VDC when the PC is connected. Deactivate VDC assignments of this type before entering Managed Mode.

To enter Managed Mode, press the **MANAGED** button; its LED will flash. The Enter/Cancel LED will also flash. Press **ENTER** to confirm the mode change or **CANCEL** to return to the previous state.

To exit Managed Mode, press the **MANAGED** button; its LED will flash and the Enter/Cancel LED will flash. Press **ENTER** to confirm the mode change. The network returns to the previous local mode, Auto or Manual.

In Managed Mode, Virtual Data Cable and channel Active buttons behave as if the module is edit locked; they provide information only when pressed. All other front panel edits are prohibited.

Edit Lock Button

The front panel of the 64160 can be locked to prevent accidental changes or low-level unauthorized access. Once edit locked, all front-panel functions under digital control cannot be changed. Analog functions, including channel output level settings can still be changed. Edit Lock can be used on a module-by-module basis.

To lock a module's front panel, press the **EDIT LOCK** button. The Enter/Cancel LED will blink. Press **ENTER** to lock the unit. No other Pro64 modules in the network are affected. Press the **CANCEL** button to exit the operation without locking the device's front panel.

To unlock a Pro64 device, press the **EDIT LOCK** button again. The Enter/Cancel LED will blink. Press the **ENTER** button to unlock the unit. Press **CANCEL** to exit, leaving the unit locked.

When a Pro64 module is edit locked, all front panel operations are inactive with the following exceptions:

- The Edit Lock button, along with the Enter button, can be used to unlock the unit.
- Level switches on I/O modules are analog controls. These cannot be locked.
- Channel Active buttons can be used to get information about the channel-to-Slot relationships.
- The VDC inc/dec buttons can be used to get info on Virtual Data Cable port assignments.

Query Functions (Get Info)

When a module is edit locked, its front-panel channel buttons can be used to get Slot info. Pressing any channel button will display the selected channel's A-Net Slot number in the A-Net Slot display.

For example, if an input module is set to the A-Net Slot range starting at 17, pressing channel button 2 will display "18," channel button 3 will display "19," etc.

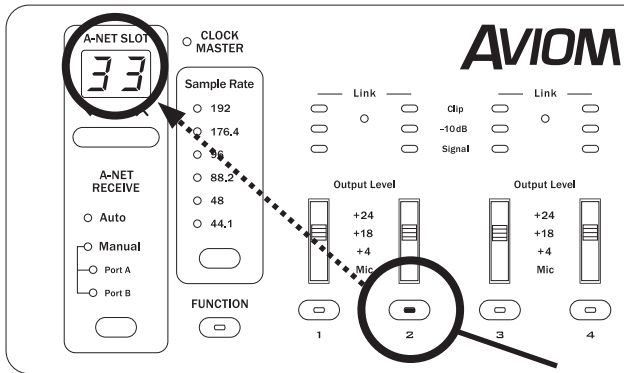

On a 64160 module set to the A-Net Slot range starting at 33, pressing the Channel 2 button displays A-Net Slot 34 when the module is edit locked. Pressing the Channel 3 button will display "35," pressing the Channel 4 button will display "36," etc.

Channel activation status is not affected by the use of the query function. It is used for information only.

To exit the query function, press **EDIT LOCK** followed by **ENTER** to return to normal operation.

Pro64 modules are set to provide query information whenever the network is in Managed Mode.

VDC Configuration

Pro64's Virtual Data Cables provide an easy way to distribute control signals throughout a network, greatly expanding the possibilities for using and distributing MIDI, GPIO, and RS-232 control signals. A-Net provides the ability to send these control data over greater distances than previously possible with traditional analog connections. And with MIDI and GPIO connections, infinite numbers of copies of the control data are available everywhere in the network.

Fourteen VDC Slots are available at all times; VDCs are not affected by the current sample rate or network mode. The makeup of the VDC Slots is user defined; no VDC Slots are reserved for specific data types.

The VDC interface includes the numeric VDC Slot display, the inc/dec buttons used for VDC Slot selection, the Assign Port list of VDC data types, and a selection button for choosing a VDC data type for the currently selected VDC Slot.

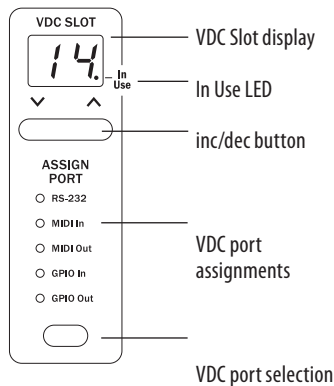

The VDC section of the user interface is used to assign VDC ports and data types.

VDC Slot Display

The two-digit VDC Slot display shows the currently selected VDC Slot (1 through 14). The In Use LED within the display indicates that a selected VDC Slot has an active input somewhere in the network. If only an output is assigned to a particular VDC, its In Use LED will not be lit.

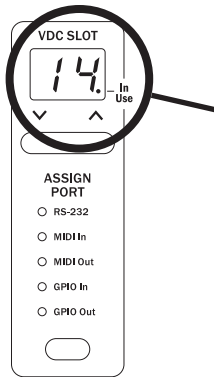

When a rear-panel VDC port has been assigned to a VDC Slot, its In Use LED will be on.

Selecting a VDC Slot is done with the inc/dec buttons below the display. Pressing the inc/dec buttons will cause the display to scroll, and will wrap at the end of the numeric list.

As the VDC Slots are displayed, any VDC Slot with an active input will light the In Use LED. If the In Use LED is not lit for a selected VDC Slot, no input is assigned to that VDC Slot and all of the VDC type LEDs in the Assign Port list will be unlit when the VDC out has been assigned locally.

The available VDC data types for the 6416o are:

- RS-232
- MIDI In
- MIDI Out
- GPIO In
- GPIO Out

VDC In Use LED

The VDC In Use LED serves to indicate that a Virtual Data Cable Slot has a current active input assignment. Output assignments for MIDI Out or GPIO Out will not light the In Use LED.

The In Use LED will light whenever a valid assignment (GPIO In, MIDI In, or RS-232) has been made anywhere in the network. The VDC Slot can only be used for the assigned data type until it has been deactivated at the point in the network where the input source has been assigned.

Assigning a VDC Slot

The act of assigning a VDC Slot maps one of the rear-panel hardware VDC I/O ports to a Virtual Data Cable. To assign a VDC port to a VDC Slot, two actions are required. First an available VDC Slot must be selected, and second, one of the VDC data types from the Assign Port list must be assigned to that VDC Slot.

To select a VDC Slot to activate, scroll through the list to a numbered location that does not have the In Use LED lit.

To assign a data type, use the selector button below the Assign Port list to select the desired VDC data type, for example MIDI In. The LED next to the selected type will light; the Enter/Cancel LED will also start to flash. Press **ENTER** to enable the VDC Slot; press **CANCEL** to exit without assigning a VDC port.

To output VDC data from the network to a rear-panel VDC port, choose a VDC Slot with an In Use LED on with the appropriate data type (for example, MIDI) for the application.

Once selected and configured, the rear-panel I/O connection for the selected VDC can be used to transfer control signals.

Deactivate an Active VDC Slot

To release an active input assigned to a VDC Slot, use the inc/dec button to scroll to the active VDC Slot. (Its In Use LED should be on.) Press the selector button below the Assign Port LEDs until no VDC data type LED is lit. The Enter/Cancel LED will be flashing. Press **ENTER** to deactivate the VDC Slot assignment and make that VDC Slot available to other modules in the network.

- ✓ **NOTE:** Only VDC inputs need to be deactivated to free Virtual Data Cable resources. VDC outputs do not reserve any of the fourteen Virtual Data Cable resources.

Advanced Functions

The available advanced functions for the 6416o Output Module are listed in the table below.

Number	Function
1	Clear A-Net Resources - Active Audio Channels and Virtual Data Cables
2	<i>Reserved for future use</i>
3	<i>Reserved for future use</i>
4	<i>Reserved for future use</i>
5	<i>Reserved for future use</i>
6	<i>Reserved for future use</i>
7	<i>Reserved for future use</i>
8	<i>Reserved for future use</i>
9	Password Lock/Unlock
10	Password Edit - Set New Password
11	Sample Alignment Lock - Get Info
12	Sample Alignment Lock - Get New Value
13	Sample Alignment Lock - Use Stored Value
14	Sample Alignment Lock - Use Default Value
15	Pro64 Operating System Update
16	Restore Factory Defaults

To exit without selecting a Function, press the **CANCEL** button. Pressing any front-panel button other than a channel activation button after the Function button will also cancel the Function request.

Function Button

The Function button is used in combination with other front-panel buttons to access features of the user interface such as setting/changing the module's password, network-wide password protection, and other Control Master settings. Functions are mapped to the channel activation buttons; the exact labeling of the buttons is determined by the I/O configuration of the module (8-channel versus 16-channel, etc.).

To access the advanced functions, press the **FUNCTION** button; its button LED will light. Next, press the channel button (or button combination) that corresponds to the desired function, followed by the **ENTER** button to activate it.

Clear A-Net Resources

This Function clears currently active audio channels, stereo links (on input modules only), and VDC assignments on a module for the current network mode, Auto or Manual. The module must be unlocked to use this feature. The network cannot be in Managed Mode.

To clear A-Net resources, press the **FUNCTION** button. The Function button and Enter/Cancel LEDs will flash. Press the **CHANNEL 1 ACTIVE** button; the VDC port assignment list and all currently active channels flash. Press **ENTER**. The A-Net resources are cleared.

To exit without clearing the current A-Net resources in use, press the **CANCEL** button.

Password Lock

Every Pro64 network can be password protected. Each module in the network stores a unique password which can be used to lock the network when that module is set to be the network Control Master.

To lock the network, press the **FUNCTION** button on the Control Master module. The Function button and Enter/Cancel LEDs will flash. Press the **CHANNEL 9 ACTIVE** button; a unique LED pattern flashes to warn the user that the network is about to be locked. Press **ENTER** to complete the operation. A special red LED sequence is displayed in the channel meters to confirm that the network is being locked.

Press **CANCEL** to exit without locking the network.

The network will be locked until the network password is provided. The **EDIT LOCK** button will light to indicate that the network is locked.

Password Unlock

When a Pro64 network is password protected, a specific four-digit password code is required to unlock it. The network can be unlocked only at the Control Master.

To unlock the network, press the **FUNCTION** button on the Control Master module. The Function button and Enter/Cancel LEDs flash. Press the **CHANNEL 9 ACTIVE** button. Key in the four-digit network password using the channel Active buttons and then press the **ENTER** button. The network is unlocked and can be edited or reconfigured. A green LED sequence is displayed in the channel meters to confirm that the network is now unlocked.

To exit the unlock request without unlocking the network, press **CANCEL** to exit.

Set a New Password

Each Pro64 module can store a network password. However, the password lock/unlock feature can only be used from the network Control Master. Passwords can be changed only when the network is unlocked.

The password is a four-digit number created using the numbered channel activation buttons 1-16 on the front panel. Passwords can include repeated numbers (such as the default factory-supplied password of 1-1-1-1). When creating a password, any string of numbers can be used, but note that only the last four button presses are stored.

To set a new password, press **FUNCTION** and then the **CHANNEL 10 ACTIVE** button. Key in a four-digit button combination and then press **ENTER**. The channel buttons flash to indicate that the new password has been set. Pressing the **CANCEL** button will exit the new password Function and leave the original password intact.

Sample Alignment

All digital networks that allow daisy-chained connectivity need to compensate for sub-millisecond latency build-up between devices when data is retransmitted. In the majority of cases, there is no audible effect (as the individual delays are very small), but without compensation, these small variations in latency can become an issue in certain applications as the network grows in size.

On power up, each device in the network will calculate a sample alignment value based on the current sample rate and will apply it as long as the network is running. The next time the network sample rate is changed or the system is power cycled, a new value will be calculated and locked in. This sample alignment value will be referred to as the *default value* in the text that follows. Using the default value will offer the simplest method of operation.

However, to guarantee repeatable latency down to the microsecond, the user has the option of measuring the sample alignment amount for a given sample rate and then applying that calculated value every time the network is powered up. This is referred to as a *stored value* in the text that follows. By using these stored values, the Pro64's unique firmware guarantees consistent delays between each component of the network.

Sample Alignment Lock Status

The sample alignment query, Function 11, can be performed on the Control Master or any remote unit in the network. The network can use the default value (created at the time of power-up) or a stored value.

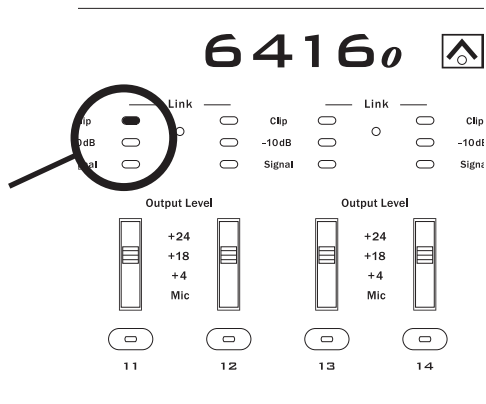

The red LED indicates that the system default sample alignment lock values are being used.

To get sample alignment info, press the **FUNCTION** button, followed by the **CHANNEL 11 ACTIVE** button. Press **ENTER**; the LEDs in the Channel 11 meter strip are used to indicate the current value in use.

- The red (Clip) LED indicates that the system's default values are being used. (This is set with Function 14.)
- The green (Signal) LED indicates that stored values are being used. (This is set with Function 13.)

Get New Sample Alignment Lock Value

To generate a new sample alignment lock value, use Function 12. This Function can only be performed at the Control Master when the network is unlocked.

Press the **FUNCTION** button, followed by **CHANNEL 12 ACTIVE** button. The sixteen yellow channel meter LEDs and the Enter/Cancel LED will flash, indicating that this operation will replace the currently stored value. Press **ENTER** to generate a new sample alignment value, or press **CANCEL** to exit without updating the stored value.

Values are stored in each module's memory but are not put into use until Function 13 (Use Stored Sample Alignment Values) is performed, which activates the stored sample alignment values. The module must be the network Control Master to use its stored value. Use Function 11 to get info on the current values in use.

When the stored sample alignment lock value is being used, a new sample alignment lock value should be calculated each time the network sample rate

is changed, or when the system configuration changes. (Changes include the addition/subtraction of Pro64 modules, different wiring schemes, etc.)

Use Stored Sample Alignment Lock Value

When a new sample alignment lock value has been generated and stored, Function 13 can be used to activate and lock in this value for use throughout the network. This Function can only be performed at the Control Master when the network is unlocked.

To use the stored value, press the **FUNCTION** button, followed by the **CHANNEL 13 ACTIVE** button. The Enter/Cancel LED and the sixteen yellow channel meter LEDs will flash. Press **ENTER** to use the stored value, or press **CANCEL** to exit without changing the sample alignment value (the system reverts to using the default value).

The stored sample alignment value remains in force even when the network is power cycled. When the network is reconfigured or when the sample rate is changed, a new value should be calculated.

Use Default Sample Alignment Lock Value

The system calculates a sample alignment lock value to be used as the default every time the network is powered up, or when the sample rate is changed. Function 14 can be used at the Control Master to set the network to use the default value. (Function 13 is used to instruct the system to use a stored value.)

To set the network to use the default sample alignment value, press **FUNCTION**, followed by the **CHANNEL 14 ACTIVE** button. The sixteen yellow channel meter LEDs and the Enter/Cancel LED will flash. Press **ENTER** to use the default value, or press **CANCEL** to exit without changing the current value.

Use Function 11 (Get Sample Alignment Info) to display the current value in use—default or stored.

Firmware Update

The Pro64 operating system firmware can be updated in the field using a PC and the Pro64 Update Tool. Modules can be updated over A-Net, while part of an active audio network, or in local mode where no other modules are connected at the time the update is being performed (such as may be required for a bench configuration when setting up modules prior to installation).

Updating a module requires the Aviom Pro64 Update Tool application, a PC host computer with RS-232 connection capability, a null modem DB9 cable, and the update file for the particular Pro64 device being updated. Refer to the Aviom website for information about the availability of the latest firmware upgrades and feature updates.

Firmware Update Connections

To update modules via A-Net, a host computer is connected to the network's Control Master via the RS-232 port in the Virtual Data Cable section of the rear panel. Individual modules are then selected and updated from within the Pro64 Update Tool. Updates can be applied to the Control Master or a slave device.

To update via A-Net, make sure that no RS-232 or MIDI VDC resources are configured on the Control Master. (Refer to the Virtual Data Cable information elsewhere in this document.) Then, enter Managed Mode by pressing the **MANAGED** button on the Control Master.

To update modules locally, the computer is connected directly to the module being updated, via the RS-232 port as described above. The Pro64 Update Tool application must also be set to its local update mode. (See the Pro64 Update Tool Help file for more information.)

Baud rates for data transfer must be set the same on the Pro64 device and PC host running the Pro64 Update Tool. Refer to the VDC RS-232 baud rate (*page 59*) to learn how to set the baud rate parameters. On the Pro64 module, RS-232 must be configured for eight data bits, no parity, and one stop bit. Also, refer to the firmware update instructions that come with the Pro64 update application for additional information on setting up the PC host.

Firmware Update - Local

Function 15 enables a Pro64 module to receive new firmware from a host PC connected to the RS-232 port on the module's rear panel. Updates can be applied to a Pro64 module set to be a Control Master or slave device.

To enable firmware updates on the module, press **FUNCTION**, followed by the **CHANNEL 15 ACTIVE** button. The Enter/Cancel LED and the sixteen red channel level LEDs will flash to indicate that this function will interrupt normal network operation. Press **ENTER** to enable the module to receive new firmware from the PC host. Send the firmware update following the instructions that came with the Pro64 Update Tool. During the update the sixteen red, yellow, and green channel meter LEDs will flash in sequence.

When the firmware update has been sent successfully, the module will reset and normal front panel operation will be restored. If for some reason the firmware update fails, refer to the error recovery information below for instructions on how to recover and complete the update.

When a module is being updated locally, the dot in the VDC Slot display will be on, indicating that a local firmware update is in progress.

When a module is waiting for a firmware update to begin, you can exit the firmware update state by pressing the **CANCEL** button. If the firmware update has not yet started, the module will attempt to reset, returning it to normal operation.

- ✓ **NOTE:** Do not press the **CANCEL** button while a firmware update is in progress.

Error Recovery

In case of a partial firmware download or interruption to the firmware transfer (as would happen because of a power failure, computer crash, or by pressing the Cancel button in the middle of a firmware update), the module can still be updated but will need to be powered up directly into the firmware load mode. To do this, hold the VDC Slot decrement (down arrow) button while powering up the unit. Then send the firmware from the computer as described previously.

If for some reason the firmware section is damaged on a unit being updated, it will default to receiving firmware update over A-Net. This will allow you to continue the firmware update procedure.

Firmware Update - via A-Net

To enable a Pro64 module to receive new firmware via A-Net on an active network, the PC must be connected to the RS-232 port on the Control Master. The network must be in Managed Mode to update firmware via A-Net. All network audio will be muted, and front-panel functions will be disabled on the module being updated.

To enable firmware updates, a module must be selected from within the Pro64 Update Tool application, at which point it will be setup to receive

new firmware. Send the firmware update following the instructions that came with the update firmware. During the update, the module's sixteen red, yellow, and green channel meter LEDs will flash in sequence. When the firmware update has been sent successfully, the module will reset and audio will be restored.

When a module is being updated via A-Net in an active network, the dot in the A-Net Slot display will be on, indicating that a network firmware update is in progress.

When a module is waiting for a firmware update to begin, you can exit the firmware update state by pressing the **CANCEL** button. If the firmware update has not yet started, the module will attempt to reset, returning it to normal operation.

- ✓ **NOTE:** Do not press the **CANCEL** button or exit the Pro64 Update Tool application while a firmware code update is in progress.

Restore Factory Defaults

Function 16 restores the Pro64 module to its factory default settings.

To restore the factory default settings, press **FUNCTION** followed by the **CHANNEL 16 ACTIVE** button. The Enter/Cancel LED and the sixteen red channel level LEDs will flash, indicating that this function will interrupt normal network operation. Press **ENTER** to continue and recall the factory default settings, or press **CANCEL** to exit, leaving the current settings in place.

The Factory Default settings are:

- A-Net Slot is set to 1.
- Auto Mode is selected.
- Sample Rate is set to 48kHz.
- All audio channels are muted and deactivated for Auto, Manual, and Managed Modes.
- All stereo links are deactivated for Auto, Manual, and Managed Modes.
- Managed Mode is deactivated.
- Edit Lock is set to off.
- Password protect is off.
- The system password value for the module being reset is "1-1-1-1."
- All Virtual Data Cables are deactivated.

The Clock Master and Control Master settings are hardware controlled and dependent upon the rear-panel DIP switch settings. These are not changed when factory defaults are restored.

VDC configuration for GPIO type—Isolated or TTL—is not reset. VDC baud rate, parity, and stop bit settings for RS-232 communication are not reset. These are hardware settings configured via the DIP switches in the VDC section of the rear-panel part of the interface.

Restoring factory defaults is a local function; only the module where the function is engaged will be reset.

Control Master

In every Pro64 network, one device will always be designated as the Control Master, the device that manages all A-Net resources for the network. The Control Master can be any I/O module in the network, and can be assigned or changed by the user as needed. Only one device can be assigned as Control Master in a Pro64 system at a time; an A-Net network cannot function without a Control Master.

The functions of the Control Master include:

- System resource and information management
- Setting network mode (Auto or Manual)
- Management of active channels in Auto Mode
- System-level command and control functions
- Keeping track of all Pro64 devices in the network (by type and quantity)
- Control of the current system-wide sample rate
- Clock Master (analog modules only)
- System lock via password on/off
- Management of Virtual Data Cable (VDC) resources
- Management of stereo link status
- Requests to enter Managed Mode

The Control Master status is identified with a red LED on the front panel of the device currently assigned as the Control Master.

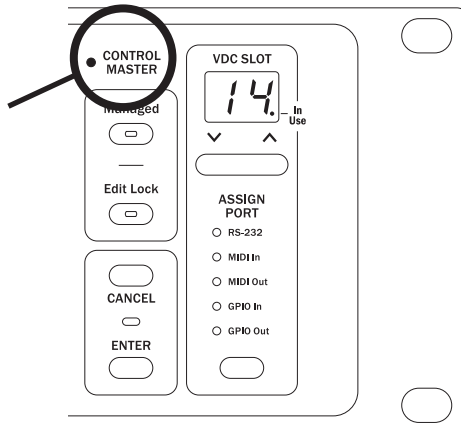

Only one device in a Pro64 network can be designated as the Control Master.

Setting Control Master Status

Setting a device to be the Control Master is done using the DIP switches found on the rear panel. The Control Master switch is part of the Virtual Data Cable port section of the interface.

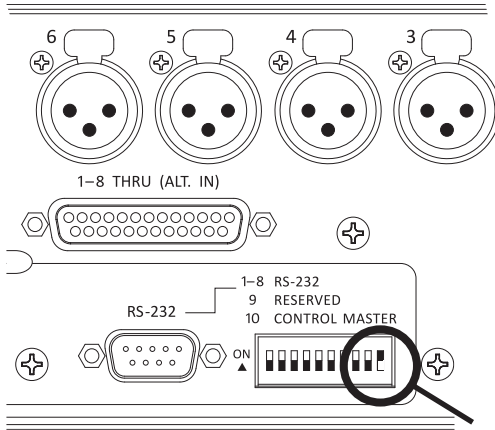

Switch 10 in the RS-232 configuration group is used to set the Control Master status for a module.

In the VDC section, locate the 10-position DIP switch in the RS-232 area of the rear panel. Switch #10 will set a module to be the Control Master for an audio network when the switch is in the On (up) position (the *up* position is shown in black in the diagram above).

Control Master Functions

This section describes the individual functions that the designated Control Master device in a Pro64 network controls.

Enumeration

When the Control Master is powered on, its first job is to identify and count all connected A-Net modules in the network in a process called *enumeration*, similar to a PC booting up and loading its operating system. The time for this process will vary based upon the number of modules in a system.

Enumeration is an automated process performed by the command and control portion of the system. There are no user-controllable functions or settings.

During the enumeration process, all connected A-Net modules will flash their A-Net LEDs, indicating that a request to be added to the network is being made. Once granted entry by the Control Master, the individual module's blue A-Net LED will light solid to indicate that it is now receiving valid A-Net packets and is part of the network.



The blue LED in the A-Net icon, shown here on a 6416i Input Module, is used to indicate network status.

If valid A-Net packets are not received, the module will reset and wait until a valid A-Net stream is detected.

During enumeration, any conflicts will also be resolved. For example, consider a new Auto Mode installation using eight input modules set to the same A-Net Slot range with all channels activated during a bench configuration. When all these input modules are connected and then powered up, only one of them will be allowed to have all 16 channels activated. The remaining seven modules will have their audio channels deactivated.

Adding Pro64 Modules to a Network

When a new device is added to an existing network, the new device makes a request to the Control Master for inclusion in the network. During this time, the new module's blue A-Net LED will flash. When the new module has been enumerated by the Control Master, its blue A-Net LED will then light solidly to indicate that the Control Master has granted the module access to the network. Adding a new module will interrupt network operation briefly.

Changing Settings

Most operations on Pro64 modules that make system-wide changes require the use of the Enter and Cancel buttons. For any operation that requires confirmation, the LED between the Enter and Cancel buttons will flash to indicate that the user needs to press one of these buttons in order to continue.

Press **ENTER** to complete the operation or press **CANCEL** to exit without making a change. This rule applies to all functions that can be changed by only the Control Master.

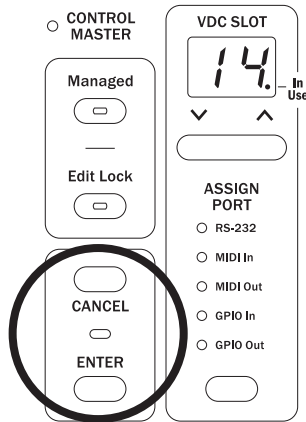

The Enter/Cancel LED will flash when the user is required to press one of these buttons in order to complete an operation.

Control Master and Clock Source

By default, the device designated as Control Master in a network consisting of all analog modules is also the device in control of the network master clock. The front-panel Clock Master LED lights to indicate that a module is designated as the master clock device.

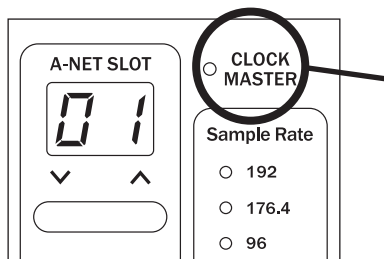

The red Clock Master LED lights when a Pro64 device is the Control Master.

When an analog I/O module is the Control Master, there is no other analog module that can be used as a clock source. When a digital I/O module is part of an audio network, the digital I/O device can be used as a clock master for the network, even if this digital device is not the network's Control Master.

External clock sources on digital modules can include:

- Word Clock - via the dedicated BNC Word Clock jack
- AES3 (AES/EBU) - from any of the available AES3 digital streams
- Clock coming from a Yamaha® console when a 6416Y2 A-Net Interface Card is installed

Clock Errors

If a clock error occurs, the Clock Master LED will blink indicating that an error has occurred. Common causes for a clock error include:

- Attempting to change the sample rate on an analog device other than the Clock Master in an all-analog network
- Attempting to change the clock source when the network is password protected
- Removing or changing external clock sources on a digital I/O module
- Incorrect configuration of an external clock source on a digital I/O module

Network Sample Rate

When an analog device is the Control Master, the Control Master is automatically designated as the Clock Master. It will remain the Clock Master until a different analog module is made the Control Master or until a digital module is added to the network and requests to be the Clock Master.

The Clock Master LED will light automatically on the Control Master when that module is powered on. (Only a digital I/O module can be the source of the network's master clock without being the Control Master.)

The system's internal master clock is derived from the sample rate currently in use. The sample rate also affects the total number of available A-Net Slots available for use in the network.

The Sample Rate section of an I/O module's front-panel interface includes a group of LED indicators for displaying the current network sample rate. One LED will be lit at all times.

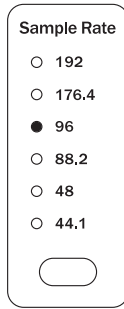

Press the selection button to cycle through the available sample rates.

The current sample rate for the network will be displayed on all I/O modules in the network. Only one sample rate can be used at a time.

Changing the Sample Rate

To set or change a network-wide sample rate from the Clock Master, use the button below the Sample Rate LEDs to select a new rate. Pressing the Sample Rate selector button will cycle through all available sample rates, flashing the value for the new rate. At the same time, the LED between the Enter and Cancel buttons will flash, indicating that pressing one of these buttons is required to confirm and complete (or cancel) the operation.

Changing the sample rate will affect the number of available A-Net Slots when the sample rate changes from the 1x range (44.1/48kHz), to the 2x range (88.2/96kHz), to the 4x range (176.4/192kHz) or vice versa.

Auto/Manual Mode Selection

The Control Master can be used to set the current network mode for the system to Auto or Manual. As with the system-wide sample rate, the network mode is also a global setting.

The network mode selection controls are in the same part of the user interface as the A-Net Slot selection. The exact front panel text of an I/O module seen in this area will vary based on the type of module. For example, an input module front panel will read A-Net Transmit, while an output module will read A-Net Receive.

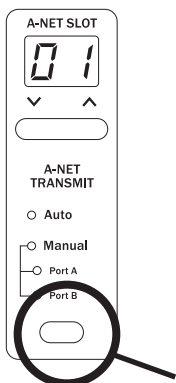

The selection button in the A-Net Transmit/Receive section of the interface is used to choose the network mode on the Control Master. (Seen here is the 6416i.)

Changing the Network Mode

The button beneath the Auto/Manual Mode LEDs is used to select the network mode and to set the transmit or receive port in Manual Mode. Pressing the selection button will cycle through the available settings and will flash both the mode LED and the Enter/Cancel LED. To confirm and change the network mode, press the **ENTER** button. The Control Master will update the display on all modules in the network to reflect the change. Press the **CANCEL** button to exit the mode change and return to the current state.

Managed Mode

Managed Mode requires the use of a computer with the Pro64 network for tasks such as firmware updates, system monitoring, control, and editing. The Control Master is the only module that can allow the network to enter Managed Mode.

Entering Managed Mode requires the user to press the **ENTER** button after pressing the **MANAGED** button on the Control Master. Once the network enters Managed Mode, all modules will light their Managed LEDs.

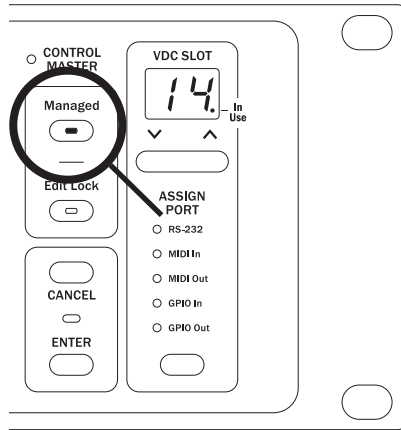

Managed Mode allows the network to be controlled from a computer and can only be entered from the Control Master.

To manage a Pro64 network with a PC, the PC needs to be connected to the Control Master using a DB9 null modem cable connected to the RS-232 port.

Exiting Managed Mode is also done from the Control Master. Pressing the lit **MANAGED** button followed by the **ENTER** button will return the network to local control. Attempting to enter or exit Managed Mode from any module other than the Control Master will cause the Managed button LED to blink to indicate the error.

Password Protection

All Pro64 devices ship with a default password. However, a Pro64 network can be password protected from the Control Master only. Once protected, the front-panel interface on all modules is locked, preventing changes to A-Net Slots, sample rate, clock source, channel activation, stereo links, and Virtual Data Cable assignments. Hardware switches, such as gain settings on input and output modules, and rear-panel DIP switches are in the analog domain and are not affected.

Password protection remains in force even when a Pro64 system is power cycled.

When a network is password protected, the front panel interface can be used to get information on channel Slot assignments and VDC routings. Pressing a channel button will display its Slot assignment in the A-Net Slot display. Pressing the VDC inc/dec buttons will cycle through the fourteen VDC Slots,

displaying any port assignments on the current module, as well as the In Use LED for all active VDC Slots in the network. This query behavior is similar to the behavior of an individual module when it is edit locked.

See the section on Advanced Functions for a detailed description of the password protection commands.

Rear Panel Features

All 6416o rear-panel features and functions are described in this section. The rear panels of the 6416o and 6416o v.2 are identical.

AC Power

Pro64 modules use switching power supplies that can operate at 100-240V and from 50-60Hz, meaning that they can be used with most of the world's AC power systems by simply changing the line cord. The 6416o is equipped with a standard grounded IEC power inlet (with fuse), which can accept the interchangeable IEC power cord.

Fuse

The fuse holder is spring-loaded and has space for two fuses, one main and one spare (optional). Press the fuse holder cover to access the fuse. When checking or replacing a fuse, always power off the Pro64 unit and remove the line cord from the AC power source.

Always replace the fuse with one of the same rating as that being changed.

A-Net Ports

Two EtherCon jacks are provided for A-Net connections, labeled A and B. Connections can use standard RJ45-style cables or cables outfitted with the locking EtherCon connector. Refer to the section on network modes for additional information about using these jacks.

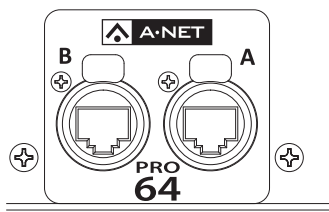

Each Pro64 device has two A-Net ports.

Balanced Line-Level Outputs

The sixteen male XLR line-level output jacks on the 6416o can deliver balanced audio signals to mixing consoles, recording devices, etc. To use either version of the 6416o Output Module with audio devices that require

a mic-level input signal, set the front-panel output level switch to the **Mic** position which includes a -40dB pad.

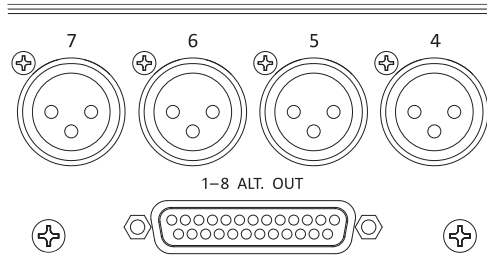

The 6416o outputs can be individually set to output line- or mic-level analog audio signals.

DB25 Alternate Audio Out

Two female DB25 multipin connectors are provided as an optional audio output on the 6416o. Channels 1-8 appear on one jack and channels 9-16 on the other. The DB25s are wired to the industry accepted Tascam® compatible analog wiring standard. Always use DB25 cables wired to analog audio standards; never connect multipin cables wired for AES3 digital connections.

- ✓ **NOTE:** Do not use the XLR jacks and DB25 Alternate Out connections for the same set of channels on the 6416o simultaneously.

DB25 Pinout

Breakout cables for DB25-to-TRS, DB25-to-XLR connections, etc., are readily available. To create a custom cable for the Audio Thru/Alternate In function, use the following table and diagram.

Cable Number	DB25 Pin Number		
	Hot	Cold	Ground
1	24	12	25
2	10	23	11
3	21	9	22
4	7	20	8
5	18	6	19
6	4	17	5
7	15	3	16
8	1	14	2
No Connect	13		

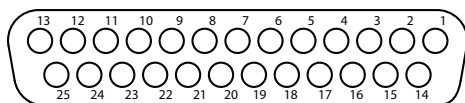

The pins on the panel-mounted DB25 jacks are numbered according to the diagram above.

The DB25 panel-mount connectors have #4-40 UNC thread.

- ✓ **Note:** Strain relief is suggested when using DB25 cable assemblies. DB25 breakout cables should always be supported when connected to a Pro64 product to reduce the risk of damaging the Pro64 product's rear panel.

Virtual Data Cable Ports

Three types of Virtual Data Cable (VDC) ports are available on the rear panel of the 6416o Output Module. See the VDC info (*page 33*) for help configuring and using the fourteen available Virtual Data Cables.

GPIO

GPIO (General Purpose Input/Output) can be used to send contact closure or voltage-type control signals through the network. Four input and four output blocks are provided. Each terminal block can be individually wired. GPIO inputs can be individually configured to be either Isolated or TTL.

GPIO Configuration DIP Switches

Each of the four GPIO Input blocks can be set to either Isolated or TTL operation using the configuration switches to the left of the terminal blocks.

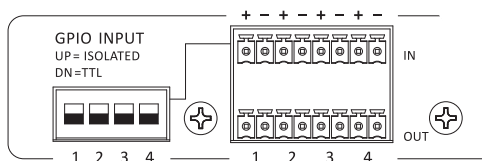

The Isolated/TTL configuration switches only apply to the GPIO inputs.

With the switch in the down position, the input is set to TTL. Use this setting for voltage-type signals. GPIO inputs set for TTL operation can handle signal voltages up to 5 Volts.

The up position (Isolated) sets the input to accept on/off switch signals. See the GPIO Specifications later in this document for additional configuration information.

GPIO Terminal Blocks

Each GPIO input or output has a positive and negative contact that can be wired as needed. Four of each are provided. Only a small screwdriver is required.

MIDI In, MIDI Out

Two MIDI (Musical Instrument Digital Interface) ports, In and Out, are provided on the 6416o. Each is capable of transferring any type of MIDI-compatible data. Pro64 devices do not process or filter MIDI data in any way.

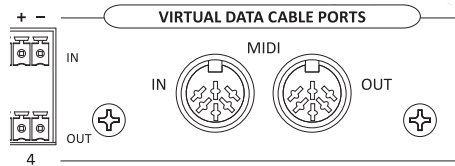

Both MIDI ports in the VDC section can be used simultaneously.

One MIDI In per Pro64 device can be assigned to a VDC Slot. An unlimited number of Pro64 modules can make use of that MIDI data by assigning MIDI Out to the VDC Slot with the same number as the input source.

Configuring a MIDI VDC

To assign a VDC to use the MIDI In port on the 6416o, first select an available VDC Slot using the inc/dec buttons below the VDC Slot readout. (VDC Slots with valid inputs that are currently in use will have the In Use dot lit.) Use the selector button to choose **MIDI In** from the Assign Port list. The MIDI In and Enter/Cancel LEDs will flash. Press the **ENTER** button to assign the port, or **CANCEL** to exit.

To output the MIDI data from the 6416o elsewhere in the network, select the same VDC Slot on the remote Pro64 device. Set the remote device's VDC type in the Assign Port list to be **MIDI Out**. Repeat this step on any other Pro64 module that needs to output the same MIDI data.

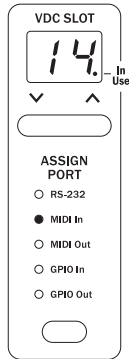

VDC Slot 14 on the 6416o is set to receive MIDI In from the rear-panel jack.

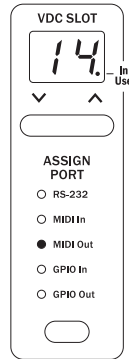

A remote Pro64 device set to output MIDI data.

RS-232 Port

The Pro64 RS-232 VDC ports allow a pair of devices to transfer control data at rates up to 57.6k baud. Using the RS-232 Virtual Data Cables always requires two VDCs because RS-232 data transfers require communicating devices to be set up in a handshaking pair. Note that RS-232 communication is point-to-point, meaning that a maximum of seven RS-232 sessions (14 total devices) are possible when using Pro64 Virtual Data Cables.

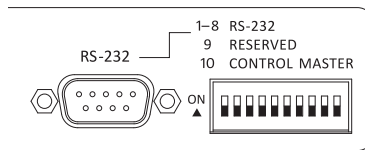

The first eight switches on the DIP switch block are used to set the RS-232 baud rate. (DIP switch handles are indicated in black.)

The RS-232 port is also used for computer communication for software updates and other Managed Mode applications.

The RS-232 port on the 6416o uses a 9-pin DB9 connector and eight of the ten DIP switches in the DIP switch block (the remainder are used for system functions).

RS-232 Configuration DIP Switches

RS-232 communication is configured using the first eight switches in the DIP switch block. Switches 1-4 set the baud rate and switches 5-9 are used to set data, parity, and stop bit options. Switches 9 and 10 are reserved for system use.

Switch	Function	Off	On
1	Baud Rate bit 3	<i>See Baud Rate chart</i>	
2	Baud Rate bit 2		
3	Baud Rate bit 1		
4	Baud Rate bit 0		
5	Data Bits	7	8
6	Parity Low/High	No parity	Parity
7	Parity Even/Odd	Even	Odd
8	Stop Bit	1	2
9	<i>Reserved</i>		
10	<i>Control Master</i>		

To set a DIP switch to the On position, push it upwards.

RS-232 Baud Rates

To set a baud rate, determine the appropriate baud rate for data transfer by referring to the external send/receive devices' documentation. Set both devices to communicate using the same baud rate. Finally, set the Pro64 devices to the same baud rate and activate the VDCs using the front-panel interface.

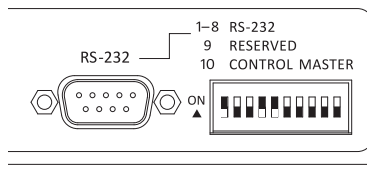

The 6416o is set for a 57,600 baud RS-232 transfer with 8 data bits, no parity, and stop bit set to 1. (Black indicates the switch handle.)

The following table lists the DIP switch settings for the available RS-232 baud rates.

Baud Rate	Switch			
	1	2	3	4
1200	off	off	off	off
2400	off	off	off	on
4800	off	off	on	off
7200	off	off	on	on
9600	off	on	off	off
14400	off	on	off	on
19200	off	on	on	off
28800	off	on	on	on
38400	on	off	off	off
57600	on	off	off	on
31250 (MIDI)	on	off	on	off

Control Master DIP Switch

In the RS-232 DIP switch block on the 6416o, switch #10 is used to set the module as the network's Control Master. Only one module can be designated as Control Master in a Pro64 network.

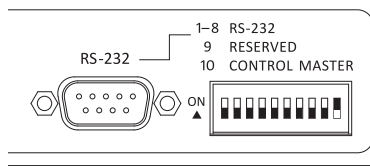

When switch #10 is in the up position, the 6416o becomes the network's Control Master. (Black indicates the switch handle.)

To set the 6416o as the Control Master, set switch #10 to the up position. The red Control Master LED on the front panel of the 6416o should be lit indicating that it is now the network's Control Master.

- ✓ **NOTE:** Be sure that only one Pro64 device is set to be the network Control Master.

Building a Pro64 Network

Configuring a Pro64 network with the 6416o involves connecting input and output modules with Cat-5e cables, setting A-Net Slot ranges, and activating input channels.

Choosing a Network Mode

When designing a digital snake or network, deciding which network mode to use—Auto or Manual—can be made simpler by assessing the total audio channel requirements for an application at a given sample rate first.

If you want to build a 48kHz system, for example, that requires no more than 64 total audio channels, choose Auto Mode; this is the easiest to implement. The network takes care of most of the management tasks automatically.

If the system is larger than 64 channels at 48kHz—for example, a 56x16 digital snake for a live performance stage to front-of-house application—choose Manual Mode. Pro64's Manual Mode offers the most flexibility but requires more care when connecting modules and configuring input routing.

Connecting Pro64 Modules

Start by setting one (and only one) device to be the network's Control Master. Because there are some operations that can only be executed at the Control Master, be sure that the module designated as the Control Master is accessible. Once all modules in the network are enumerated (indicated by illuminated A-Net LEDs), choose a network mode (Auto/Manual), set A-Net Slot ranges on each module, and activate audio channels and VDCs as needed.

When adding input modules to an existing audio network running in Manual Mode, it is best to add modules that are not pre-configured with active channels and/or VDC Slots in use to avoid unwanted overwriting of A-Net Slots. Pro64 output modules' audio channel on/off settings do not cause conflicts with the allocation of audio input resources but existing VDC settings on these modules *can* impact the network. It's best to clear old settings before adding modules to a system.

Basic Routing

To use the analog audio outputs on the 6416o, the module must be connected to another Pro64 device somewhere in the network that can provide inputs. This Pro64 device can be a standalone analog or digital module or a console interface card.

The diagrams that follow use generic input and output module icons. Any Pro64 I/O device can be substituted unless otherwise noted.

Auto Mode Connections

In Auto Mode, the 6416o's A-Net ports on the rear panel can be connected in any combination to other Pro64 devices. In the following examples, network performance and functionality are unaffected by the changes in cabling.

Example 1: Port A connected to Port B

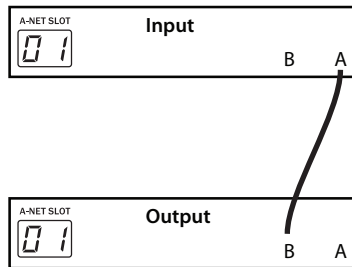

The A-Net cable can be connected to either Port A or Port B. Reversing the A-Net connections causes the same results. Either port can be used to expand the network.

Up to 16 audio Slots can be output as analog signals from the 6416o Output Module. The Pro64 devices shown can be connected using either Port A or Port B. In both cases, the channels made active on the network's input modules will be available at the output module.

Remember that the entire 64-channel A-Net stream (at 48kHz) is always received and transmitted through every Pro64 module. The A-Net Slot selection simply tunes a module in to a specific range of channels.

Example 2: Port B connected to Port A

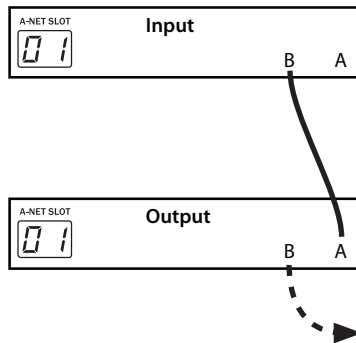

In this diagram, note that additional Pro64 modules can be connected to any available port as indicated by the dotted line.

The same results can be achieved by connecting Port A on the input module to Port A on the output module and by connecting Port B on the input module to Port B on the output module.

Digital Copies in Auto Mode

Any number of digital copies (also referred to as digital splits) can be created by simply connecting additional Pro64 output devices and setting them to the same A-Net Slot range. In Auto Mode, the order and location of the modules in the network does not matter; output modules can be connected before or after any input module. Optionally, Pro64 modules can be connected in parallel via a Pro64 merger hub such as the MH10.

Any Pro64 input and output modules that are set to the same A-Net Slot range can input or output data, making the configuration of large networks straightforward.

Transmitting and receiving A-Net data are independent of the A-Net Slot selection and the module type.

Example 3: One input module and three digital copies in Auto Mode

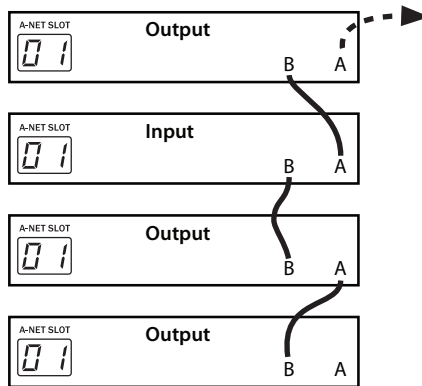

In this example, note that the A-Net connections between devices can be any combination of the A and B ports. Any open port can be used to connect additional Pro64 devices.

The order of the Pro64 modules connected in series in Example 3 above can be changed without affecting the ability of the network to distribute the same incoming audio channels to all three output modules shown. A-Net ports always transmit and receive the entire network (audio and VDC data) at all times.

The rules are the same when larger networks are created. Simply set different A-Net base Slots on the I/O modules to use more A-Net Slots as needed. Cables can be connected to any available A-Net port, A or B. Remember that in Auto Mode that the maximum number of active input channels at 48kHz will be 64.

Adding a Merger Hub in Auto Mode

For more wiring options, an A-Net Merger Hub such as the MH10 or MH10F can be added to a network. Using a merger hub enables parallel connection of A-Net devices. Multiple merger hubs can be used to simplify gear rack wiring and distribution of digital signals amongst the various subsections of a digital audio network.

- ✓ **NOTE:** Standard Ethernet networking products are not compatible with Pro64 products. Use only A-Net compatible devices.

Example 4: One input module and three output modules connected using an MH10 in Auto Mode

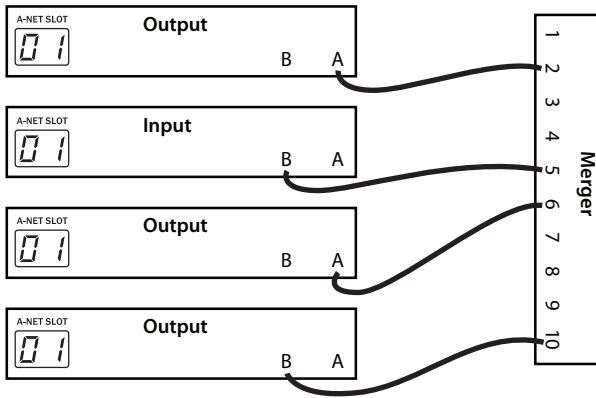

In Auto Mode, modules can be connected to any port on the MH10.

Note that in the example, it does not matter which A-Net port (A or B) on the I/O modules is connected to the MH10. Likewise, on the MH10, the choice of A-Net port (1 through 10) does not matter. Any audio made active on the Pro64 input module in the diagram will be available to all output modules.

Manual Mode Connections

When creating bidirectional networks that require more than 64 channels (at 48kHz), Manual Mode is the answer. Unlike Auto Mode, Manual Mode requires that the user pay attention to which A-Net port (A or B) is used when connecting network cables to each module. As implemented in the Pro64 Series of products, A-Net is a truly bidirectional stream of up to 64x64 channels at all times.

In the examples that follow, the diagrams will indicate the specific A-Net port on an I/O module that is in use with a square as shown below. Input modules such as the 6416i can send active audio channels to Port A, Port B, or both Ports A and B.

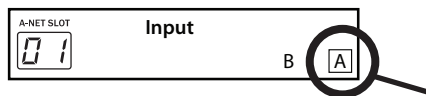

Port A is being used to send active audio inputs into the network, indicated by the square surrounding the "A" Port.

Example 5: One input module and two output modules in Manual Mode

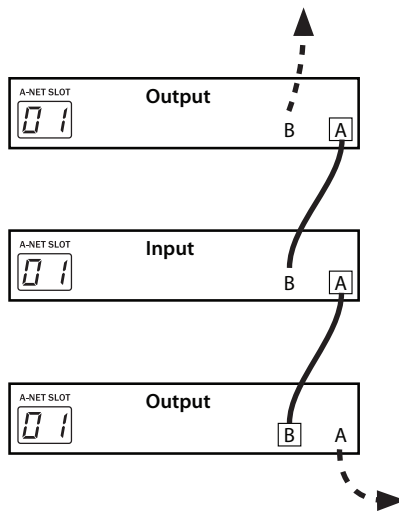

The input module transmits its audio data via Port A (marked with a square surrounding the port name). Only the lower Pro64 output module can make use of those audio channels.

In the example above, showing three modules in the middle of a network, the input module in the center of the diagram is set to send its active audio data to Port A, using the A-Net Slot range starting at 1. The output module below it is set to listen to any A-Net data that arrives on its Port B. The output module at the top of the diagram is set to listen to data arriving at its Port A.

Since the input module is directing its data to Port A, only the bottom module can output the audio channels made active on the input module. Again, the example assumes that all modules are set to the same A-Net Slot range. Remember that all network audio is always transmitted and received at each A-Net port. The module's Slot Range selection simply tunes into a specific range of channels.

Example 6: Two input modules and two output modules, 16x16

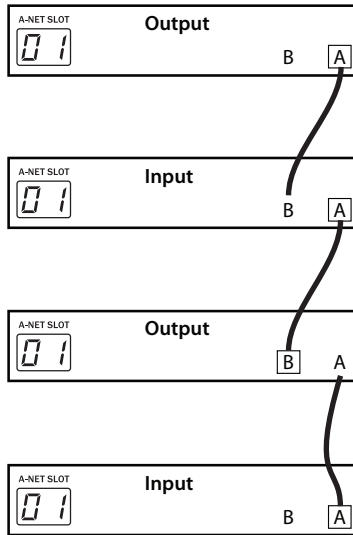

Audio from the Pro64 input module at the bottom of the diagram is heard at the output module shown at the top of the diagram.

In this example, two input modules are set to the same A-Net Slot range (01). Both modules are set to send their A-Net data out of Port A. Unique data flows in each direction in a 16x16 configuration. Each output module will receive data from only one of the input modules in the configuration.

The next example refines this drawing by adding specific locations for the modules in a traditional stage-to-FOH snake system.

Example 7: Audio from the Stage is output at the front-of-house mixing console; audio from the FOH console is output on the stage.

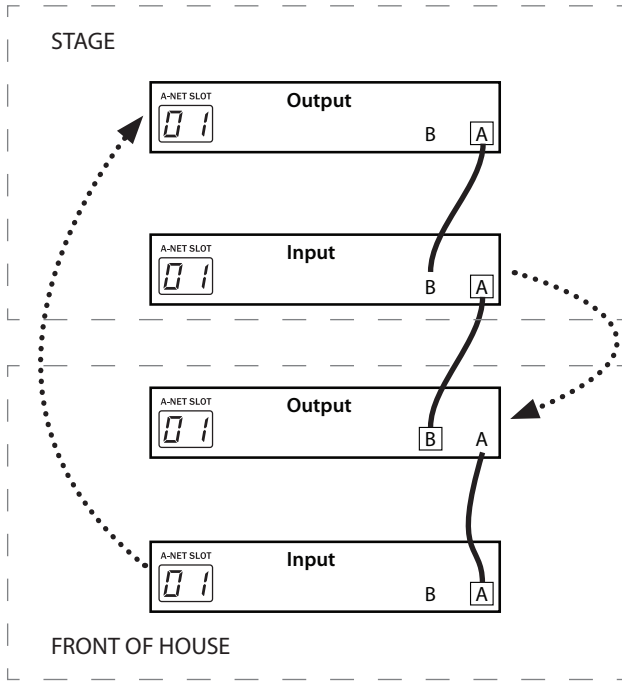

The dotted arrows show the relationship of the input and output modules.

By defining the uses of the audio data from the two input modules in the previous example as Stage and FOH, the picture is clearer. Audio from the input module seen at the bottom of the diagram (at FOH) travels up through all the modules in the network; its audio is available at the output module at the top of the diagram.

Audio from the input module on the stage travels through the network to the FOH position where it is output to the mixing console by the Pro64 output module there.

Digital Copies in Manual Mode

Creating a digital split in Manual Mode follows most of the rules defined for Auto Mode splits. Any output modules connected in series to an existing output module can output the same audio as long as the A-Net Slot range and A-Net Receive Port settings are configured properly, and as long as no input modules installed overwrite the audio. However, the location of the Pro64 output modules used for the splits will impact the front-panel transmit port settings of the input modules.

In the previous example of a stage and front-of-house system, adding a digital copy of the FOH engineer's inputs for a recording system can be accomplished by connecting Pro64 output modules to the input module at front-of-house. Unlike Auto Mode, however, this input module needs to be set to send audio data to its A-Net Port B in order to make the digital split work.

Example 8: Adding a digital split of the FOH signals

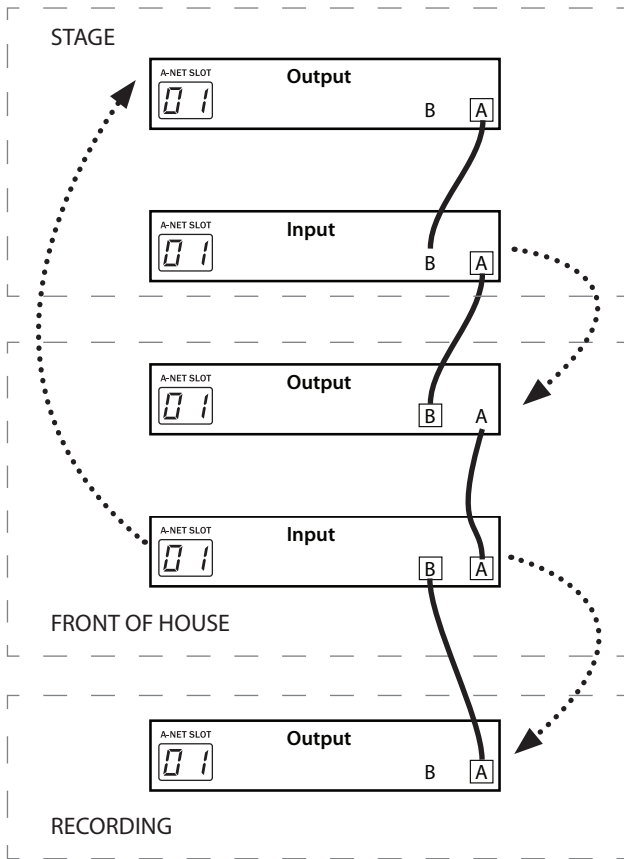

The input module at FOH transmits its audio data out of both A-Net ports, providing a digital split.

The example assumes that all modules are set to the same A-Net Slot range. By setting the FOH input module to send its A-Net data to Port A *and* B, the A-Net data flows in two directions. Digital audio arriving at the front-of-house location from the stage is replaced by the input module at FOH.

To send the stage audio to the recording system instead, set the input module at front-of-house to send its data out Port A only. By doing this, the audio from the stage flows through all the modules to the recording system.

Example 9: A digital copy of the stage signals

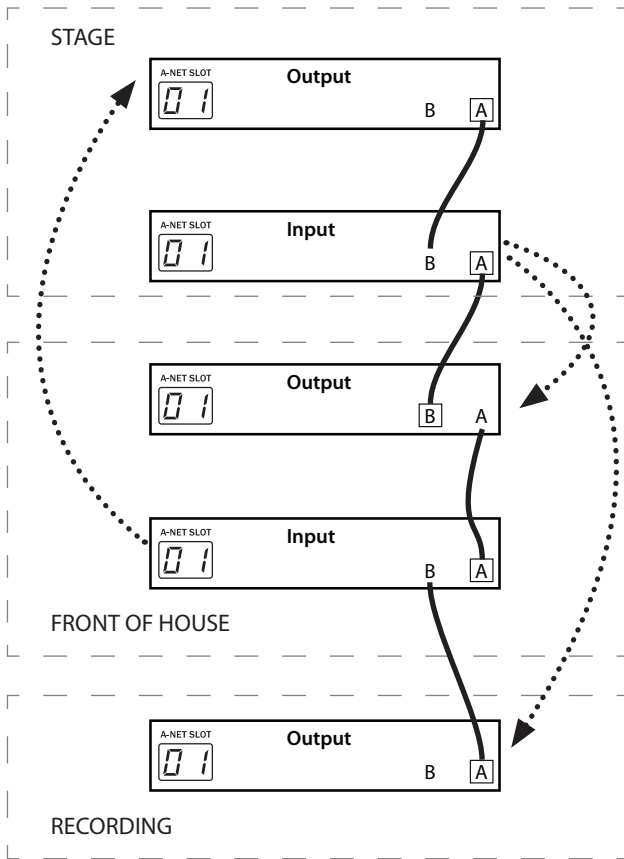

The input module at the front-of-house position is set to transmit its A-Net data out of Port A only. The dotted lines show the relationship of the input and output modules.

By changing the A-Net transmit port settings on the input module at front-of-house, audio from the stage can be output in the recording area.

Specifications

6416o	
XLR Output (line level)	Pin 1: Ground; Pin 2: Hot ; Pin 3: Cold ; Impedance balanced; signal on hot only
Alternate Audio Output	(2) DB25 connectors; Analog audio pinout on DB25
Output Levels	+4dBu, -17dBu 2-position switch
Output Impedance	91 ohms
Frequency Response	-3dB at 2Hz and 23kHz ± .5dB 3.0Hz–22kHz (at 1x sample rate)
6416o v.2	
XLR Outputs	Pin 1: Shield; Pin 2: Hot; Pin 3: Cold Impedance balanced for Mic, +4dBu, and +18dBu, Signal on hot only; Full differential for +24dBu
Alt. Audio Outputs	DB25 multipin; analog audio pinout
Output Impedance	200 ohms for Mic and +4dBu; 450 ohms for +18dBu and +24dBu
Output Levels	+4dBu, +18dBu, +24dBu, or Mic; 4-position switch per channel
Max. Output Level	+24dBu
6416o and 6416o v.2 Common Specs	
Audio Channels	16 mic or line-level outputs
Audio Metering	LEDs: Green -40dB; Yellow -10dB; Red 0dB
A-Net I/O	(2) EtherCon RJ45 connectors
Sample Rates	44.1/48kHz; 88.2/96kHz; 176.4/192kHz
Sample Rate Range	1x 44.1/48kHz, 39.7kHz to 52kHz 2x 88.2/96kHz, 79.4kHz to 104kHz 4x 176.4/192kHz, 158.8kHz to 208kHz
Bit Depth	24-bits
Latency	Total latency is less than 800µs (measured from analog in to analog out).
Cable Length, Cat-5e	Maximum 400 feet (120 meters); Use Unshielded Twisted Pair (UTP) cable
DB25 connector	Thread size is #4-40 UNC
Crosstalk	<100dB at 1kHz
THD +N	< .002% at -10dBFS

Signal to Noise Ratio (unweighted)	D/A: -111dB		
Maximum Ambient Temperature	50°C		
Virtual Data Cables (VDC)			
	GPIO	4x in; 4x out	Isolated or TTL
		Inputs: 4 terminal blocks, individually configurable as Isolated or TTL	
		Outputs: 4 terminal blocks	
		Maximum inputs to network VDC slots: 14	
	MIDI	In, Out	5-pin DIN
		Maximum inputs to network VDC slots: 14	
	RS-232	DB9 connector	DIP switch configured
	RS-232 Baud Rates	1200, 2400, 4800, 7200, 9600, 14400, 19200, 28800, 38400, 57600, 31250 (MIDI)	
Maximum inputs to network VDC slots: 7			
Power Supply	100-240VAC	50-60Hz, 24W	
	Internal switching power supply; IEC connector, interchangeable		
Fuse	F4AL		
Dimensions	2U; 19" w x 8" d x 3.5" h 482.6 x 203 x 88 mm		
Weight	9 pounds; 4.1 kg		
<i>All Aviom products are designed and manufactured in the USA.</i>			

Dimensions

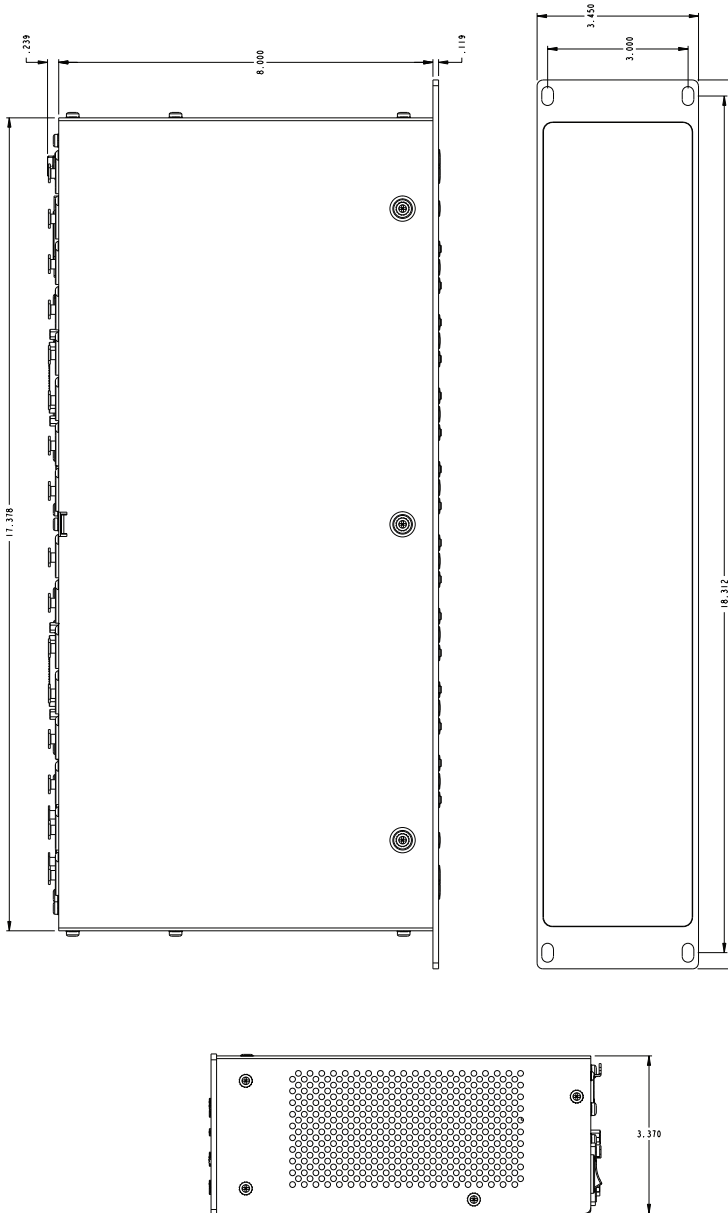

6416o Block Diagram

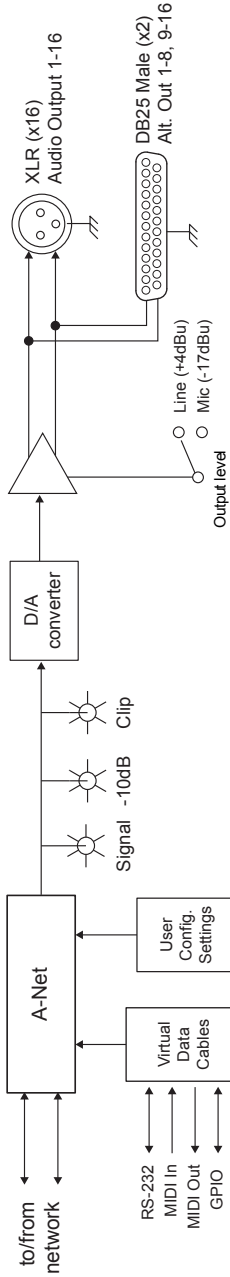

6416o

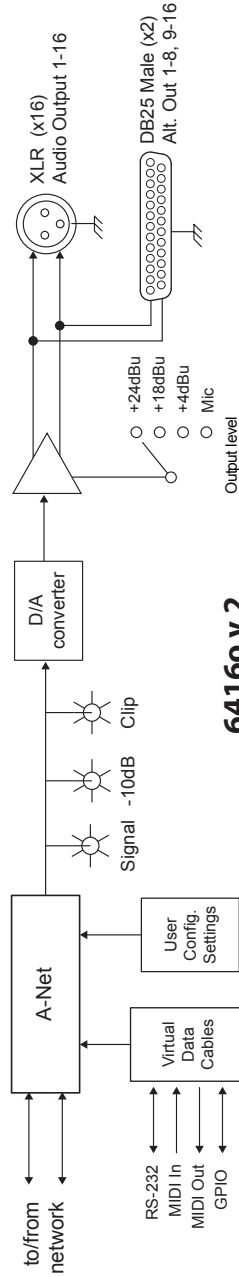

6416o v.2

GPIO Specifications

The following table lists the specifications for the General Purpose Input/Output (GPIO) terminal blocks found on Pro64 Series products.

INPUT MODE	Parameter	Conditions	Symbol	Rating
TTL	Input isolation to chassis		Rin iso	1 Mohms
ISOLATED	Use only with on/off switch-type signals.			
ISOLATED/TTL	Input Voltage	Minimum	VIL	2V
		Maximum	VIH1	17V
	Bandwidth		BW	200 Hz
	Output Current (Continuous)	Outputs are overcurrent protected with PTCs.	IL2	330 mA
	Output Current (Peak)	PW=100 msec (1 shot)	I _{fp}	1.5A
	Output isolation to chassis		Rout iso	1.00E+09 ohms
	Output On-State Resistance	IL = 500 mA	R _{on}	0.85 - 2.5 ohms
	Output Breakdown Voltage		V _{br}	60V

Ratings subject to change without notice.

Inputs are reverse polarity protected up to 17VDC.

GPIO Plugs

Plugs used with the GPIO terminal blocks have the following specifications.

Pitch	3.81 mm	
Number of positions	8	
Type of connection	Screw	
Screw thread	M 2	
Conductor cross section AWG/ kcmil	minimum 28	maximum 16
Plugs used with Pro64 products are compatible with Phoenix Contact™, part number 1803633, or equivalent.		

MIDI/GPIO Cable Lengths

To meet the EN55103-2 (Electromagnetic Susceptibility/Immunity) Specification, any cables connected to the MIDI and/or GPIO ports must not exceed three meters in length. Use of cables longer than three meters will not guarantee equipment conformance to EN55103-2.

Factory Default Settings

When a Pro64 module is reset to the factory default settings using Function 16, the following settings are restored:

- A-Net Slot is set to 1.
- Auto Mode is selected.
- Sample Rate is set to 48kHz.
- All audio channels are muted and deactivated for Auto, Manual, and Managed Modes.
- All stereo links are deactivated for Auto, Manual, and Managed Modes.
- Managed Mode is deactivated.
- Edit Lock is set to off.
- Password protect is off.
- The system password value for the module being reset is "1-1-1-1."
- All Virtual Data Cables are deactivated.

Index

Symbols

6416o v.2 1
6416o v.2 output level 32

A

A-16II, A-16R
 Personal Mixers 4
About A-Net 2
AC fuse
 changing 56
AC Line Conditioning 6
AC Power 56
Active button 30, 33
active channel 12, 30, 31, 33, 47, 67
active channels
 clear 31
Adding Pro64 Modules 49
AES3 51
AES3 (AES/EBU) 28, 57
AES/EBU 51
Alternate Audio Out 57
Alternate Audio Output 74
Alternate Audio Outputs
 DB25 22
Alternate Output
 DB25 1
analog input
 Level Meters 31
analog I/O 50
analog output
 -40dB pad 32
analog switches
 gain 32
A-Net 1
 Pro64 Series 2
 Slot assignment 54
A-Net Distributor 4
A-Net LED 20, 24, 49
A-Net Port 65, 68, 71
 A or B 67
 Manual Mode 67
A-Net Ports 3, 17, 56
 A and B 23
A-Net Receive 27, 52, 71
A-Net Slot 11, 15, 17, 29, 30, 51
 inc/dec buttons 13

 Query Functions 34
A-Net Slot Configuration 19, 25
A-Net Slot Display 13, 14, 26
 during firmware update 45
A-Net Slot number 34
A-Net Slot range 26, 68
 selecting 13
A-Net Transmit 52
A Port 56
arrows
 up/down, inc/dec 8
ASI A-Net Systems Interface 4
Assign a VDC input 37
Assign a VDC output 37
Assign Port
 VDC 35, 36, 37
Audio Metering 74
Auto LED 27
Auto/Manual mode LEDs 53
Auto/Manual Mode Selection 19, 52
Auto Mode 3, 17, 47
 active channels 31
 Available A-Net Slots 12, 17
 Merger Hub 66
Auto Mode Connections 64
Available A-Net Slots 17

B

Balanced Outputs 56
base Slot 26
Baud Rates 43
 DIP switch 62
 RS-232 61-62
bench configure 24
bidirectional 3, 67
Bit Depth 74
Block Diagram 77
blue A-Net LED 49
BNC Word Clock jack 51
B Port 56
Button Presses 8

C

- Cable Length
 - MIDI, GPIO 79
- Cables
 - Cat-5e, Cat-6 2
- cable specification, Cat-5e 8
- Cancel button 20, 49
- Cat-5
 - stranded vs. solid 8
- Cat-5e 1, 8
 - Unshielded Twisted Pair (UTP) 8
- Cat-5e Cable Distance 2
- Cat-6 8
- Certifications ii
- Changing the Sample Rate 52
- Changing Values 8
- Channel 11
 - Slot assignment 54
- Channel Activation Button 19, 30, 40
- Channel Activation Rules 31
- channel active switch
 - mute 31
- channel info 54
- Channel Level Meters 31
- channel pairing. *See Channel Link*
- channel range 64
- channels
 - clear 39
- Channel-Slot relationship 13
- Cleaning 7
- clear active channels 31
- Clear A-Net Resources 38, 39
- Clip LED 31
- Clock 2
 - external 29
 - jitter and wander 2
- Clock Errors 51
- Clock Master 3, 10, 28, 30, 47, 50, 51, 52
 - reset 45
- Clock Master LED 28, 30, 50, 51
- Clock Source 51
 - AES/EBU 51
 - External 51
 - Sample Rate 48
 - Word Clock 51
- compatibility
 - Pro16 4
- computer 43
- configuration
 - Auto Mode 65
- Connecting Pro64 Modules 63

- console interface card 63
- Control Data 3
- Control Master 10, 17, 24, 33, 39, 47, 53, 62
 - assigning 48
 - Clock 48
 - DIP switch 24, 48
 - password 40
 - reset 45
 - Sample Alignment Lock 41
 - sample rate 29
- Control Master DIP Switch 23, 62
- Control Master Errors 25
- Control Master LED 20, 47, 62
- control signals 35
 - GPIO 58

D

- D/A converter 30
- Data Bits 61
- DB9 75
 - RS-232 60–62
- DB9 cable
 - null modem 43
- DB25 1
 - Alternate Audio Outputs 22
 - strain relief 58
- DB25 Alternate Audio Out 57
- DB25 connector 74
- DB25 connector thread 58
- DB25 Pinout 57
- Default Settings 45, 79
- default value 40
- Digital Copies 65
 - Manual Mode 71
- digital I/O 28, 50, 51
- digital module 51
- digital split 30, 72
- Dimensions 75, 76
- DIP switch 54
 - Baud Rates 62
 - Control Master 24, 45, 48, 62
 - GPIO 58–62
 - GPIO, RS-232 22
 - RS-232 48, 60–62
- DIP Switches 9

E

- Edit Lock 32, 45, 55, 79
 - Managed Mode 33
 - VDC query 33

- Edit Lock Button 20, 33
- Enter button 20, 49
- Enter/Cancel button 8, 10, 24
- Enter/Cancel LED 11, 49, 53
- Enumeration 25, 48, 63
- Error Recovery
 - Firmware Update 44
- EtherCon 1, 8, 23, 56
- Ethernet 2
 - compatibility 66
- External Clock 29. *See also Clock*

F

- Factory Default settings 45
- Factory Default Settings 79
- fiber 2
- firmware update 24
- Firmware Update 38, 43
 - Error Recovery 44
- FOH snake 17
- Frequency Response 74
- Front Panel Components 19
- front panel lock 33
- Function
 - Clear A-Net Resources 38
 - Operating System Update 38
 - Password Lock/Unlock 38
 - Restore Factory Defaults 38, 45
 - Set New Password 38
- Function 01 39
- Function 09 39
- Function 10 40
- Function 11 41, 42
- Function 12 41, 42
- Function 13 42
- Function 14 42
- Function 15 43
- Function 16 45
- Function Button 19, 38
- Function List 38
- Fuse 75
 - AC 56
- Fuse Holder 21

G

- gain settings 54
- GPIO 35, 36, 46, 58–62, 75
 - Cable Length 79
 - DIP Switch 58–62
 - General Purpose I/O 3
 - isolated 78

- reset 46
- Specifications 78
- TTL 78
- GPIO Configuration DIP Switches 58
- GPIO DIP Switches 22
- GPIO Plugs 78
- GPIO Specifications 59
- GPIO Terminal Blocks 22

H

- Hub
 - MH10 66

I

- IEC connector 75
- IEC power cord 56
- IEC Power Inlet 21
- inc/dec buttons 8, 26
 - A-Net Slot 13
- Input Impedance 74
- inputs 63
- Interface Conventions 8
- Internal Clock 51. *See also Clock*
- In Use LED
 - VDC 36, 59
- Isolated 46, 75
 - GPIO 58, 78

J

- jitter 2

L

- Latency 74
- LED 74
- level 33
- Level Meter
 - analog input 31
 - LEDs 19, 31
- line-level 1, 32
- Line-Level Outputs 21
- Link button 32
- lock the network 39

M

- Managed button 20, 33, 53, 54
- Managed Mode 33, 34, 39, 53
 - enter/exit 33
- Manual LED 27

- Manual Mode 3, 17, 27, 47, 67
 - active channels 31
 - Available A-Net Slots 12, 18
- Master Clock 50, 51. *See also Clock*
- Merger 66
- MH10f 2
- MH10 Merger Hub 65
- mic input
 - 40dB pad 32
- mic-level signal 57
- MIDI 3, 22, 35, 75
 - Cable Length 79
 - Configuring VDC 59–62
- MIDI In 59
- MIDI In/Out 36
- MIDI Out 59
- Mode Selection 52
- Monitor Mixing System
 - Pro16 4
- Mounting, Rack 6
- multipin
 - DB25 57
- mute
 - channel active switch 31
- muted audio 25

N

- network audio resource 11
- Network Mode 10, 17, 47, 53, 63
 - Auto/Manual 52
 - defaults 45, 79
- Neutrik EtherCon. *See EtherCon*
- null modem cable 54
 - DB9 43, 54
- numbered channel buttons
 - password 40

O

- Operating Level 74
- output
 - 40dB pad 32
- output level 1
 - 64160 v.2 32
- Output Level Switch
 - edit lock 33
- output module 65, 71
- Outputs
 - Line-Level 56

P

- pad
 - 40dB, mic input 32
- parallel 2
- parity 61
- Password 32, 38, 47
 - default 40
 - Edit Lock button 39
 - reset 45, 79
 - Set New Password 38, 40
- Password Lock 39
- Password Protection 45, 54, 79
- Password Unlock 39
- PC 43
 - connecting, Managed Mode 54
 - firmware update 43
- Personal Mixer
 - A-16II, A-16R 4
- Pinout
 - DB25 57
- Plugs
 - GPIO 78
- Port 17
- Port A, B 65, 67. *See A-Net Ports*
- port assignments
 - VDC 33
- Port LED 27, 28
- Ports
 - A-Net 3
 - Power On/Off Switch 21
- Power Supply 56, 75
- Pro16 Series 4
- Pro64 2
- Pro64 Modules 49
- Pro64 Series 13
- Pro64 Update Tool 43, 44

Q

- query
 - channel and VDC info 54
- Query Functions 34
 - A-Net Slot, VDC 34
 - Edit Lock 33
 - in Managed Mode 33

R

- Rear Panel Components 21
- Restore Factory Defaults 38, 45
- RJ45 1, 8
- RoHS ii

- routing
 - I/O hardware 13
- RS-232 3, 22, 35, 36, 43, 46, 75
 - and firmware update 43
 - and Managed Mode 33
 - DB9 60–62
 - DB9 null modem cable 54
 - DIP Switches 22
 - null modem cable 43
- RS-232 Baud Rates 43, 61–62
- RS-232 DIP Switches 48, 60–62
- RS-232 Port 60
- RS-422 3

S

- Sample Alignment 40
- Sample Alignment Lock 41, 42
- Sample Rate 2, 12, 18, 19, 29, 30, 42, 47, 51, 74
 - A-Net Slots 51
 - available A-Net Slots 12
 - changing 29, 52
 - Clock 48
 - default 45, 79
 - minimum/maximum 2, 29
- sample rate conversion 3
- sample rate converter 29
- sample rate LED 13
- Sample Rate LED 52
- Selecting Values 9
- selection button 9
- serial 2
- Set New Password 38, 40
- signal present LED 31
- Signal to Noise Ratio 75
- slave module 25
- Slot 4, 11
 - base 26
- Slot assignment 14
 - channel 54
- Slot Configuration 19
- Slot range 15, 26
- Slot range display 12
- Slots 11, 13, 51
 - available 18
 - per Sample Rate 12
- Slots versus Channels 11
- Specifications 74
- split 65, 71
- stage-to-FOH snake 17
- Stereo Link 47
- Stereo Link Button 19

- Stereo Link LED 32
- stop bit 61
- stored value 40, 41
- Strain relief
 - DB25 58
- stranded vs. solid Cat-5 8
- system examples 64, 67, 68, 69, 72, 73
- system-wide changes 49

T

- Terminal Blocks 75
 - GPIO 59
- Terminal Block Specs
 - GPIO 79
- THD 74
- thread type
 - DB25 connector 58
- TTL 46, 75
 - GPIO 58, 78

U

- Unlock network 39
- Unshielded Twisted Pair 8
 - UTP 74
- Update
 - Operating System 38, 43
- Update Tool 43
- up/down, inc/dec
 - arrows 8
- UPS 6
- User Interface 10
- UTP 8
- UTP cable
 - Cat-5e, Cat-6 2

V

- VDC
 - Assign Port 35, 37
 - clear 39
 - DIP switches 48
 - In Use dot 59
 - In Use LED 36
 - Query Functions 34
 - reset 46
- VDC Configuration 20
- VDC inputs 37
- VDC In Use LED 35, 36
- VDC outputs 37
- VDC Slot 10, 35
 - assigning 37

- selecting 36
- unassigning 37
- VDC Slot display 35
 - during firmware update 44
- Ventilation 7
- Virtual Data Cable Ports 22, 58
- Virtual Data Cables 3, 47, 75

W

- wander 2
- Weight 75
- word clock 28, 51

X

- XLR 12, 21, 74
- XLR line-level outputs 56, 56–62

Y

- yellow channel meter LEDs 41

Warranty Registration

Please take a moment to fill in this warranty registration form. Return it to Aviom via mail or fax. All information will be kept confidential.

Model Number _____ Product Serial Number _____

Model Number _____ Product Serial Number _____

Model Number _____ Product Serial Number _____

Model Number _____ Product Serial Number _____

Date Purchased _____

Dealer Name _____

Dealer Location _____

Your Name _____

Address _____

Address _____

City _____

State/Province _____

Zip/Postal Code _____

Country _____

Email Address . _____

Fax this form to Aviom at +1 610-738-9950

AVIOM[®]

1157 Phoenixville Pike, Suite 201 • West Chester, PA 19380
Voice: +1 610.738.9005 • Fax: +1 610.738.9950 • www.Aviom.com