

USER'S MANUAL

mini V



ARTURIA®
YOUR EXPERIENCE • YOUR SOUND

Programming:

Robert Bocquier
Thomas Diligent
Nicolas Bronnec
Pierre-Jean Camilieri
Sylvain Gubian

Xavier Oudin
Gilles Pommereuil
Cédric Rossy
Vincent Travaglini

Graphics:

Morgan Perrier
Yannick Bonnefoy (Beautifulscreen)
Thomas & Wolfgang Merkle (Bitplant)

Manual:

Robert Bocquier
Thomas Diligent
Jean-Michel Blanchet
Houston Haynes
Tom Healy
Xavier Oudin

Gilles Pommereuil
David Poncet
Mitsuru Sakaue
Noritaka Ubukata
Antoine Back

Sound-designers:

Jean-Michel Blanchet
Clay Duncan
Celmar Engel
Mateo Lupo
Chris Pittman
Klaus Peter Rausch
Klaus Schulze
Scot Solida
Noritaka Ubukata
Katsunori Ujiie
Thomas Koot

Very special thanks to:

Robert A. Moog, Michael Adams, Houston Haynes

Thanks to:

Steve Dunnington, Randy Fuchs, Roger Luther (moogarchives.com), François Haÿs, Mark Vail, and the numerous beta testers.

© ARTURIA S.A. – 1999-2014 – All rights reserved.
30, Chemin du Vieux Chêne
38240 Meylan
FRANCE
<http://www.arturia.com>

Information contained in this manual is subject to change without notice and does not represent a commitment on the part of Arturia. The software described in this manual is provided under the terms of a license agreement or non-disclosure agreement. The software license agreement specifies the terms and conditions for its lawful use. No part of this manual may be produced or transmitted in any form or by any purpose other than purchaser's personal use, without the express written permission of ARTURIA S.A.

Products, logos or company names quoted in this manual are trademarks or registered trademarks of their respective owners.

November 2014 edition

TABLE OF CONTENTS

1	FROM THE FIRST BOB MOOG'S SYNTHESIZERS UP TO TAE	7
1.1	THE GENESIS OF THE 1971 REFERENCE MONOSYNTH	7
1.2	A BETTER EMULATION THANKS TO TAE®	11
1.2.1	Aliasing-free oscillators:	11
1.2.2	Better reproduction of analog waveforms:	11
1.2.3	Better reproduction of analog filters	13
1.2.4	Implementation of the soft clipping	14
2	ACTIVATION & FIRST START	15
2.1	REGISTER & ACTIVATE	15
3	QUICK START	15
3.1	USING THE PRESETS	16
3.1.1	Modifying this preset	17
3.2	THE PLAYING MODES	18
3.3	OVERVIEW OF THE "CLASSIC" MODE	20
3.4	THE "EXTENDED" MODE	21
3.4.1	The modulation matrix	21
3.4.2	The LFO	22
3.5	THE ARPEGGIATOR SECTION	23
3.6	THE EFFECTS SECTION	23
3.6.1	The chorus	23
3.6.2	The delay	24
3.7	THE REAL TIME CONTROLLERS AND MIDI ASSIGN	24
4	THE INTERFACE	27
4.1	USE OF PRESETS	27
4.1.1	Choice of a bank, sub-bank, preset	27
4.1.2	Creation of a bank, sub-bank, preset	29
4.1.3	Saving a user preset	29
4.1.4	Import/ Export of a bank of presets	29
4.2	THE SOUND MAP	30
4.2.1	Opening the sound map	32
4.2.2	The sound map interfaces	33
4.2.2.1	The sound map main interface	33
4.2.2.2	The Sound Map overview	34
4.2.2.3	The instrument type filter window	35
4.2.2.4	Preset snap shot memories	36
4.2.2.5	The "Morphing" interface	36
4.2.2.6	The list preset manager	38
4.3	USE OF CONTROLLERS	39
4.3.1	Potentiometers	39
4.3.2	Switches	39
4.3.3	Pitch Bend wheel	39
4.3.4	Virtual keyboard	40
4.3.5	MIDI control	40
4.3.5.1	Learn menu	40
4.3.5.2	Assigning MIDI controls	40
4.3.5.3	Manage configurations	41
4.3.5.4	Minimum and maximum bounds	42
4.3.5.5	Multiple assigned parameter	42
4.3.5.6	Tricks	43
5	THE SYNTHESIZER	44
5.1	THE OSCILLATORS	45
5.2	THE MIXER	46
5.3	THE FILTER AND ITS ENVELOPE	47
5.4	THE OUTPUT VOLUME AND ITS ENVELOPE	48
5.5	THE POLYPHONIC MODE, THE PLAYING MODES	49
5.6	THE PITCH BEND AND MODULATION WHEELS	50
5.7	THE MOTION RECORDER	51

5.7.1	<i>The Motion Recorder activation/deactivation</i>	51
5.7.2	<i>Playing recorded Motion curves</i>	51
5.7.3	<i>Recording a parameter motion curve in real time</i>	52
5.7.4	<i>Erasing a recorded automation in real time</i>	52
5.7.5	<i>Quantizing a motion curve</i>	52
5.7.6	<i>Setting the modulation amount of a motion curve</i>	53
5.7.7	<i>The parameters available for the Motion Recorder</i>	53
5.7.8	<i>Editing a motion curve</i>	54
5.7.8.1	The Edit tools.....	54
5.7.8.2	The Curve Editor screen.....	55
5.8	THE VOCAL FILTER.....	55
5.9	THE LOW FREQUENCY GENERATOR.....	57
5.10	THE MODULATION MATRIX.....	57
5.11	THE ARPEGGIATOR.....	58
5.12	THE CHORUS AND STEREO DELAY.....	59
6	THE BASICS OF SUBTRACTIVE SYNTHESIS	60
6.1	THE THREE MAIN ELEMENTS.....	60
6.1.1	<i>The oscillator, or VCO</i>	60
6.1.1.1	Triangle.....	61
6.1.1.2	Sawtooth.....	61
6.1.1.3	Square.....	62
6.1.1.4	Pulse Width Modulation.....	62
6.1.1.5	Synchronization.....	62
6.1.1.6	Frequency modulation.....	63
6.1.2	<i>The noise module</i>	63
6.1.3	<i>The Mixer</i>	64
6.1.4	<i>The filter or VCF</i>	64
6.1.4.1	The cut-off frequency.....	64
6.1.4.2	The resonance.....	65
6.1.5	<i>The amplifier or VCA</i>	65
6.2	OTHER MODULES.....	66
6.2.1	<i>The keyboard</i>	66
6.2.2	<i>The envelope generator</i>	66
6.2.3	<i>The low frequency oscillator</i>	67
7	A FEW ELEMENTS IN SOUND DESIGN	69
7.1	SUBTRACTIVE SYNTHESIS.....	69
7.1.1	<i>A simple bass sound</i>	69
7.1.2	<i>A 3 oscillators lead sound</i>	71
7.1.3	<i>A polyphonic accompaniment</i>	72
7.2	THE MODULATION MATRIX.....	73
7.2.1	<i>Using the arpeggiator</i>	75
7.3	THE EFFECTS OF THE MINI V.....	75
7.3.1	<i>The stereo chorus</i>	76
7.3.2	<i>The stereo delay</i>	77
8	MODES OF OPERATION	78
8.1	STANDALONE.....	78
8.1.1	<i>Launch the application</i>	78
8.1.2	<i>Configuration of the instrument</i>	78
8.2	VST 2.....	79
8.3	VST 3.....	79
8.4	RTAS.....	79
8.5	AU.....	79
8.6	64 BIT COMPATIBILITY.....	79
8.7	USE IN CUBASE/NUENDO (VST).....	80
8.7.1	<i>Instrument use in VST mode</i>	80
8.7.2	<i>Rescan the plug-in directory in Cubase</i>	81
8.7.3	<i>Saving of presets</i>	81
8.8	USING IN PRO TOOLS (RTAS).....	81
8.8.1	<i>Opening of the plug-in</i>	81
8.8.2	<i>Saving the presets</i>	82
8.8.3	<i>Automation under Pro Tools</i>	82

8.9	USING IN LOGIC, MAC OS X (AU).....	83
8.10	USING IN ABLETON LIVE (AU AND VST)	83
9	MINI V END USER LICENSE AGREEMENT	85

*"Mind you, neither of us had any idea where this was leading"**

1.1 THE GENESIS OF THE 1971 REFERENCE MONOSYNTH

Robert A. Moog was born in May 1934 in New York. With a passion for music (he took piano lessons for 12 years), he was introduced to electronics by his father, an engineer. During his adolescence he discovered the Thereminvox plan, invented during the 1930's by a Russian engineer, Leon Theremin (or more exactly Lev Sergeivitch Termen). Seduced by this instrument with its never before heard sounds, he began to produce his own models and founded his own company in 1954.

Frequenting musical professionals, and in particular electronic and concrete music, Bob Moog realized that there was a real demand for electronic instruments of a higher quality.

One of the first clients to come to Robert Moog, the professor of music Herbert A. Deutsch, asked him to listen to a song he had composed. Bob Moog is immediately convinced and they decided to associate their work. Their co-operation produced the first voltage controlled oscillator (VCO).

In 1964, the first prototype of a synthesizer designed by Bob Moog was produced. It was a modular system with a voltage controlled filter (VCF), an envelope generator, a white noise generator, a trigger and two keyboards each with a generator module (sawtooth, triangle and square) as well as a voltage controlled amplifier module (VCA).

A second prototype, grouping those new modules all together, was built during summer 1964 and shown at the AES (Audio Engineering Society) autumn show, where Bob Moog took advantage of an unused stand. In 1965, upon the success encountered at this show, he decided to release the 900 series for sale.

In 1967, Bob Moog decided to release different machines, each with a certain number of modules. This marked the birth of modular systems I, II and III. In 1968 worldwide recognition came with the success of "Switched-On Bach" by W. Carlos. This album, where classical music is played on a synthesizer of the brand, sold over one million copies and won 3 Grammy awards.

*: Bob Moog, quoted by Mark Vail, in his book *Vintage Synthesizers* © Miller Freeman 1993



The modular system III (1967)
Courtesy of Roger Luther, MoogArchives.com

Success grew, and big groups like Tangerine Dream, the Beatles and the Rolling Stones would also become modular system owners.

In 1969, the company which at that time had around 40 employees was building up to 3 modulators per week and the order book was always full. The modular synthesizer series had 5 years of high sales, and sold around 200 models in the United States*.

However, the sales would rapidly decrease, because the gigantic proportions of modular units puts a damper on the interest of most musicians and also prevents the instrument from entering most music shops, and therefore from being known. Furthermore, a serious competitor, ARP, has just arrived on the market.

In the same time, Bob Moog received requests for a more compact instrument that could be transported more easily, directed more to stage than studio. With the help of an engineer from Berkeley, Jim Scott, and the advice from numerous musicians he was about to create another legendary synthesizer: its famous 1971 monosynth...

"Here it is! A compact, moderately priced electronic music synthesizer designed for live performance." This is the way this new synthesizer is introduced on the very first promotional brochure, in the midst of 1971. The monophonic synthesizer required several months of research and development and 4 prototypes, before leading to the commercial model. More than 12,000 units were sold until 1981. They were quite far from the 10 modular units per month that the company produced in the late 60's.

*: In 2003, Arturia has released a software emulation of the famous modular synthesizers designed by Bob Moog under the name of Modular V.

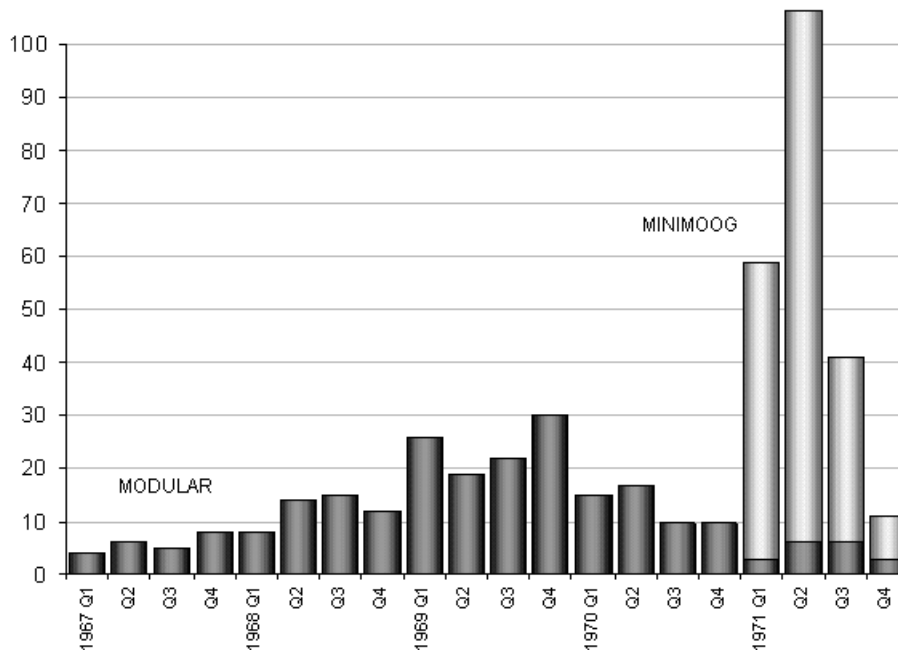

*Bob Moog's synthesizers sales figures - 1967-1971
 Courtesy of Roger Luther, MoogArchives.com*

The very first prototype was called Model A. Three other versions, B, C and D, followed. This last model is the final and most common incarnation of this synthesizer and the only one that was put into production in large numbers. The choice of wood rather than plastic for the cabinet prevailed from the beginning, simply because Robert Moog preferred to follow the advice of musician friends, rather than drawings coming from its industrial engineers. The Model D was first introduced at the NAMM convention in June 1971. It was the company's first exposure to the music instruments industry - and the industry's first exposure to synthesizers. The reception is rather cold as, according Robert Moog himself, "Most dealers didn't know what to make of a musical instrument with words like Oscillator Bank and Filter printed on the front panel!"*



*Bob Moog's monosynth, Model A (prototype)
 Courtesy of Roger Luther, MoogArchives.com*

*: op. cit.



Model D

Courtesy of Roger Luther, MoogArchives.com

The iconic monosynth knew an unparalleled success during the 1970's. Artists and bands like Tangerine Dream, Kraftwerk, Depeche Mode, Keith Emerson, Jean-Michel Jarre, Klaus Schulze, and Rick Wakeman used the synthesizer, notably for the typical sound and its very warm quality, which is excellent for basses and lead sounds.

After the production stopped in 1981, there had been during the 1990 decade, several failed attempts to restart production of the 1971 monosynth. With the arrival of computer music technologies, it has been very often mimicked as a virtual instrument, with little success. Arturia Mini V is the latest avatar, and thanks to the TAE® technology, we dare to think it is probably the most accurate emulation of this cornerstone of analogic synthesis available on the market.

1.2 A BETTER EMULATION THANKS TO TAE®

TAE® - standing for True Analog Emulation - is a new technology dedicated to the digital reproduction of analog circuits.

When implemented in software code, TAE® algorithms guaranty the respect of hardware specifications. This is why the Mini V offers an unparalleled quality of sound.

In detail, TAE® means:

1.2.1 Aliasing-free oscillators:

Standard digital synthesizers produce aliasing in high frequencies, and also when using Pulse Width Modulation or FM.

TAE® allows the production of totally aliasing-free oscillators in all contexts (PWM, FM...), and at no extra CPU cost.

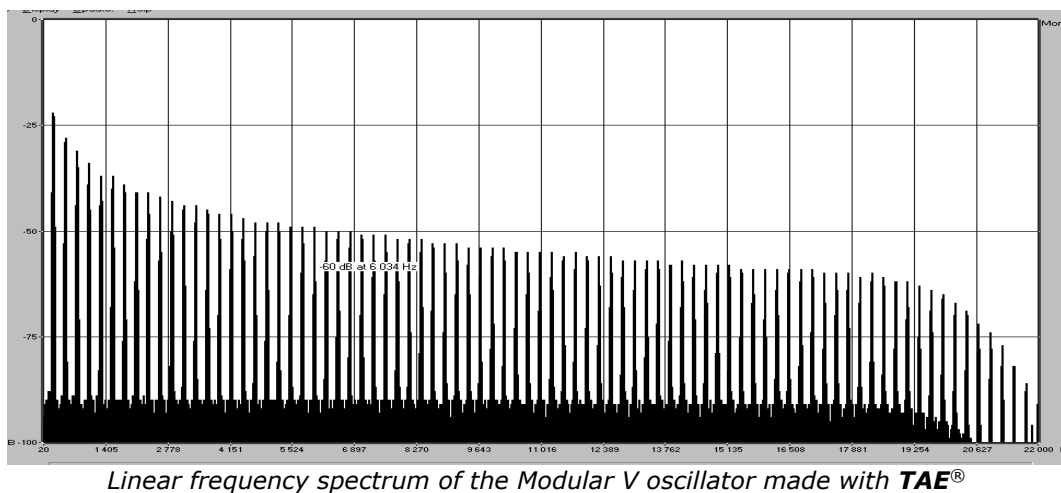
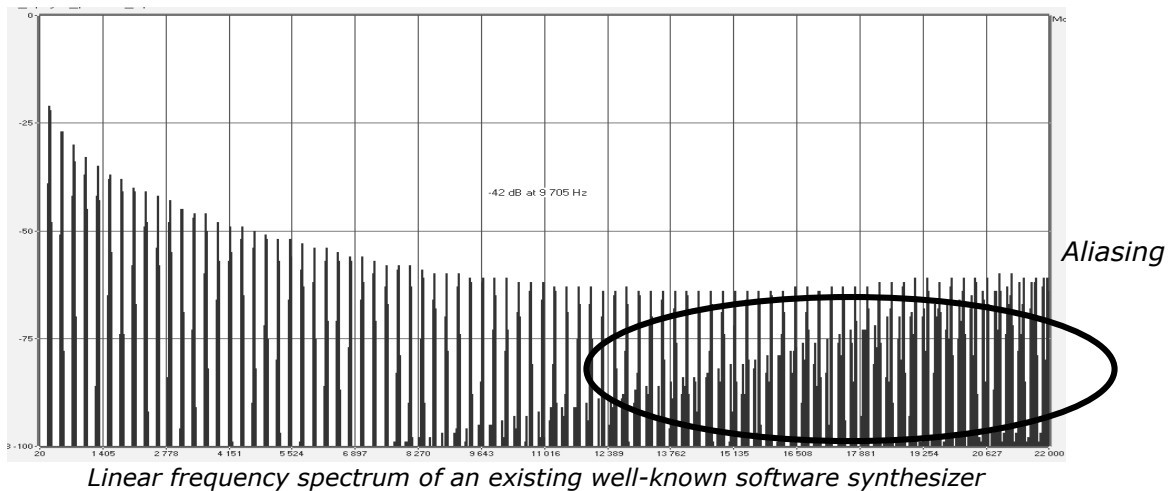

1.2.2 Better reproduction of analog waveforms:

Original analog oscillators used capacitors charge and discharge cycles to produce common wave shapes (saw tooth, triangle, square). This means that waveforms were slightly curved. TAE® allows the reproduction of the capacitors discharge.

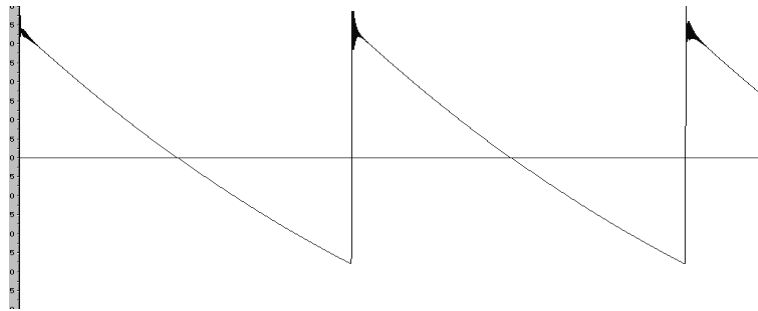

*Temporal representation of a waveform on a **1971 monosynth***

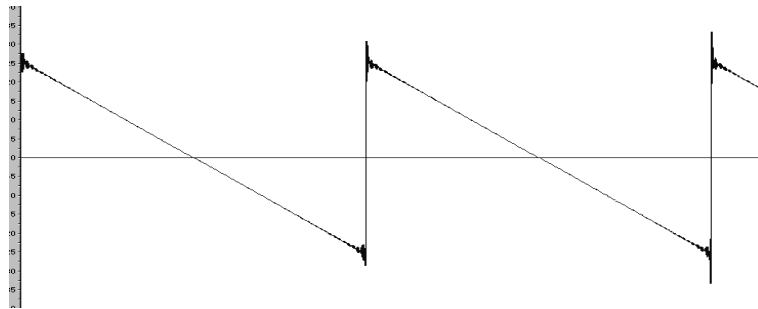

Temporal representation of the waveform from a common emulation

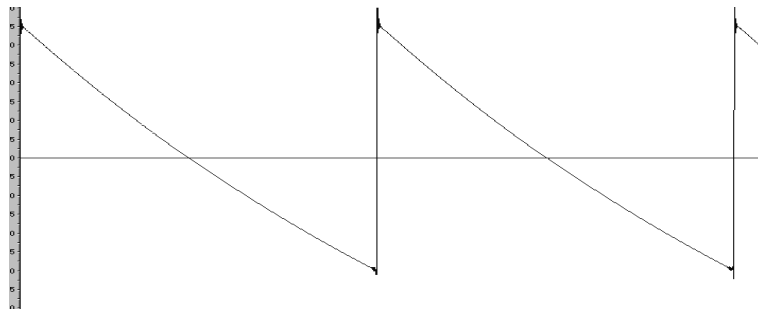

Temporal representation of the Mini V waveform thanks to TAE®

In addition, original analog oscillators were unstable. Actually, their wave shape was always slightly different from one period to another. In addition, due to analog hardware sensitivities, new period trigger times varied with the temperature and other environmental conditions.

TAE® simulates the instability of oscillators, helping to create warmer sounds, often given the affectionate term of "fat".

1.2.3 Better reproduction of analog filters

TAE® allows the emulation of analog-designed filters in a much more precise way than any existing digital filter. In particular, TAE® has managed to reproduce the legendary 24dB low-pass resonant filter equipping Bob Moog's synthesizers with great respect towards the original.

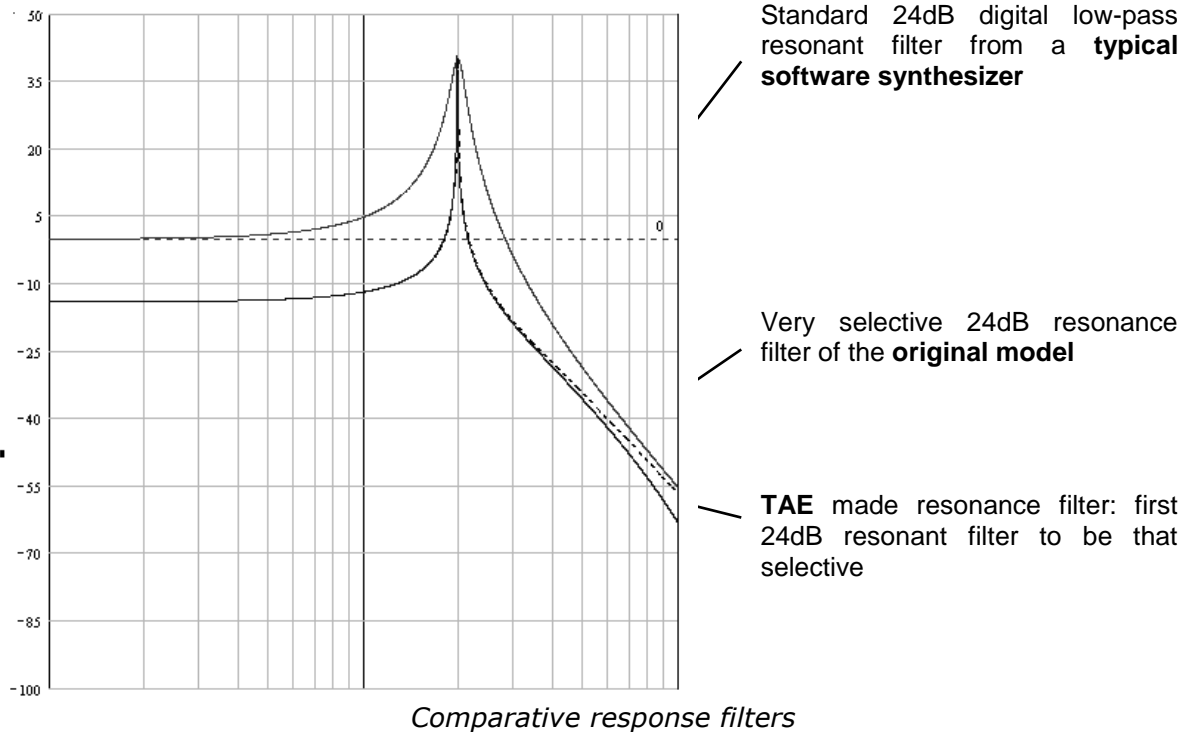

1.2.4 Implementation of the soft clipping

In analog synthesizers, particularly on Bob Moog's synthesizers, the resonant filter as the VCA uses a current limiting function, preventing the signal from being too loud (soft clipping).

TAE® reproduces this current limiting function, making the sound more natural. It also allows filters to enter self-oscillation like original hardware synthesizers do.

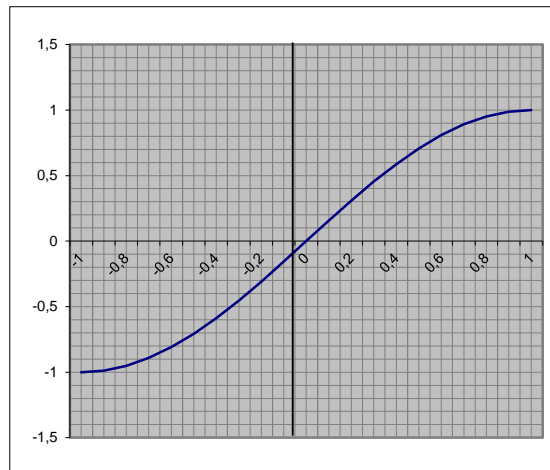
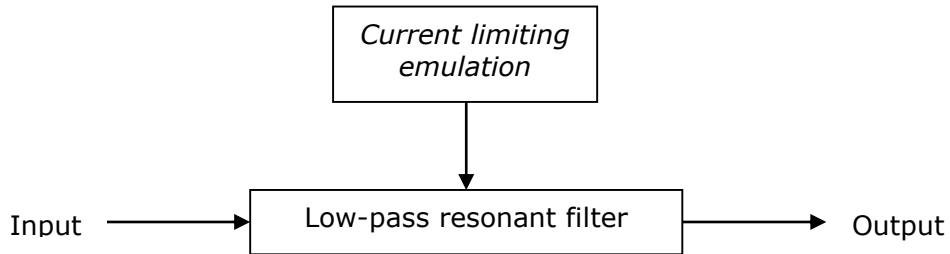

Soft-clipping transfer function

2

ACTIVATION & FIRST START

Mini V works on computers equipped with Windows 7 or 8 and Mac OS X 10.7 or later. You can use the stand-alone version or use **Mini V** as an Audio Units, AAX, VST2 or VST3 instrument.



2.1 REGISTER & ACTIVATE

Once the Mini V has been installed, the next step is to register the software.

The registration process will require you to enter the serial number and the unlock code you received with the product.

In order to proceed, go to this web page and follow the instructions:

<http://www.arturia.com/register>

Note: If you don't have an Arturia account yet, you will need to create one. The process is quick, but it does require that you can access your e-mail address during the registration process.

Once you have acquired an Arturia account you will be able to register the product.

3

QUICK START

This chapter will help you get to know the main aspects of how the Mini V works. You will be presented an overview of the different parts of the synthesizer while using the program for the first time. You will find a detailed description of all visible settings and controllers in the chapters that follow.

Chapter 6, "*A few elements of sound design*", is specially recommended for users who have never worked with a subtractive synthesizer before and who wish to learn the basics in this domain.



Overview of the Mini V

3.1 USING THE PRESETS

Use of presets is one of the major areas of evolution when the Mini V is compared to the original, which couldn't save sounds!

With the Mini V, a preset (memorized sound) contains all of the parameter settings of the synthesizer plus the extension panel and the different real-time effect controllers necessary to reproduce the sound.

To get to know a few of the different sounds contained in the Mini V, we will select a simple bass preset.

- ▶ To do this, click on button aside the "BANK" LCD display (this display shows the name of the current bank in use). When you click, you will see a dropdown menu indicating the available banks. Choose the "J.M.Blanchet" bank.

When this menu is open, it expands the sub-menus allowing you to reach the "SUB BANK" and "PRESETS" of a sound designer with a single click.

- ▶ Choose the "SUB BANK" called "Basses" and finally select "JMB_Classic1" in the "PRESETS".



Select the preset JMB_Classic1

The Mini V comes with 400 presets, which will familiarize you with the sounds of the synthesizer. A bank called "Templates" offers a selection of presets with a basic configuration (or template) to start programming a sound.

The sound "1_Osc", for example, comes with: an oscillator directed to the low-pass filter, with the signal then routed to the VCA.

It is also possible to see all of the presets corresponding to a given type of sub-bank by choosing the "All" option in the bank. For example, to see all of the bass presets click on "All" in the bank selection and then on "Basses".

3.1.1 Modifying this preset

For this, we will start with a very simple manipulation.

- ▶ Modify the brightness of the "JMB_Classic1" sound using the "Cutoff Frequency" potentiometer of the filter. Turn this potentiometer and you will hear the tone of the sound becoming more or less "brilliant". Set this potentiometer to your convenience.

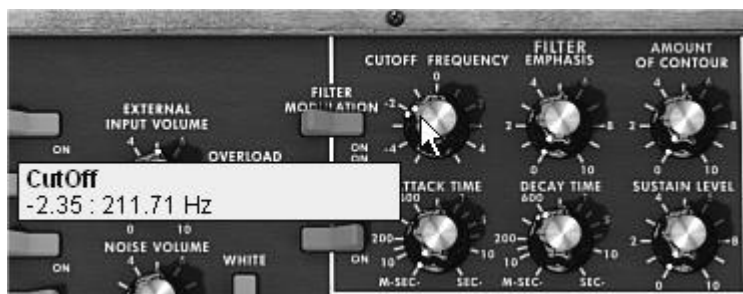

Change the brightness of the sound

- ▶ In the same manner, you can change the range of oscillator1 by turning the “Range” potentiometer to one of the six values expressed in steps (like on organs). The lower the number, the higher the pitch of the sound. (The standard tuning is found at the value 8’)



Setting the range of oscillator 1(“Range”)

By performing these first settings, you have already modified the “JMB_Classic1” preset. You can now save the sound that you have just created.

- ▶ To save a “user” preset, click on the save icon on the toolbar: the settings of the current sound will be saved in the selected preset without changing the name.

If the current preset is a “factory” preset, the factory preset will not be overwritten.

- ▶ To choose another destination for this sound, click on the “Save as” icon and select a destination. For example, select “New” in the choice of bank. 2 new emplacements for bank and sub-bank and a new preset are immediately created. The names “new bank”, “new sub bank...” and “new preset...” appear in their respective menu locations.
- ▶ Click on each of them to change the names.



Saving a preset

3.2 THE PLAYING MODES

The Mini V offers 2 playing modes:

The “**Classic**” mode allows using the original configuration of the original model. Some additional features: the oscillator 2 can be synchronized to the oscillator1, the oscillator 2 can be disconnected to the keyboard following circuit, poly/mono/unison switches have also been added.

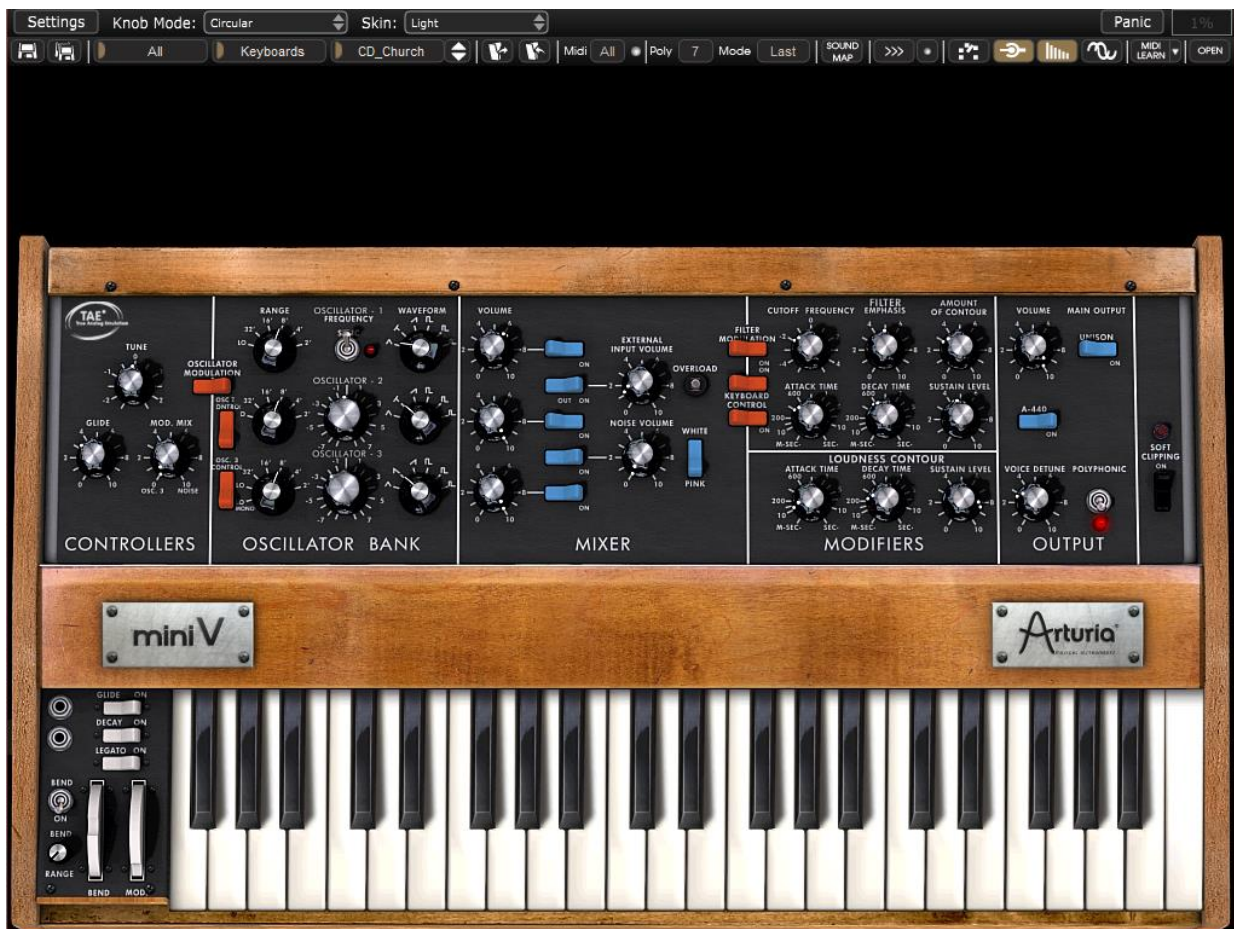

The Classic mode (same as the original)

The “**Extended**” interface gives access to a motion recorder, a vocal filter, a LFO, a modulation matrix, an arpeggiator and two effects. These different functions will enrich the basic settings of the Mini V.



The panel of the “Extended” mode

- ▶ To access the “Extended” mode, click on the wooden crosspiece situated above the synthesis settings or on the “Open” button on the right of the toolbar.
- ▶ To return to the “Classic” mode, simply click again on the wooden crosspiece or on the “Close” button.



Opening the extension panel

To use the Mini V exactly like the original model, you must also deactivate the chorus and delay effects on the toolbar and switch off the polyphony toggle in the output section.

3.3 OVERVIEW OF THE "CLASSIC" MODE

The "Classic" mode holds 50 synthesis settings, which will allow you to conceive an infinite variety of sounds. The knobs and switches associated to these parameters are found regrouped on the panel above the keyboard.

These parameters are composed of:

3 oscillators (VCO) which deliver the base audio signal thanks to 6 wave forms (triangle, sawtooth 1 and 2, square, rectangle 1 and 2) and manage the height of the sound (the frequency). The third can also be used as a modulator when its signal is directed to the filter or oscillators.

A **Mixer** allows you to mix the signals coming from the oscillators or the noise module.

A **low-pass 24dB** resonant filter

An **ADS** envelope modulating the low-pass filters

1 amplifier (VCA) allowing the amplification of the signal coming from the filter to direct it to the stereo output.

An **ADS** envelope modulating the signal going through the amplifier.

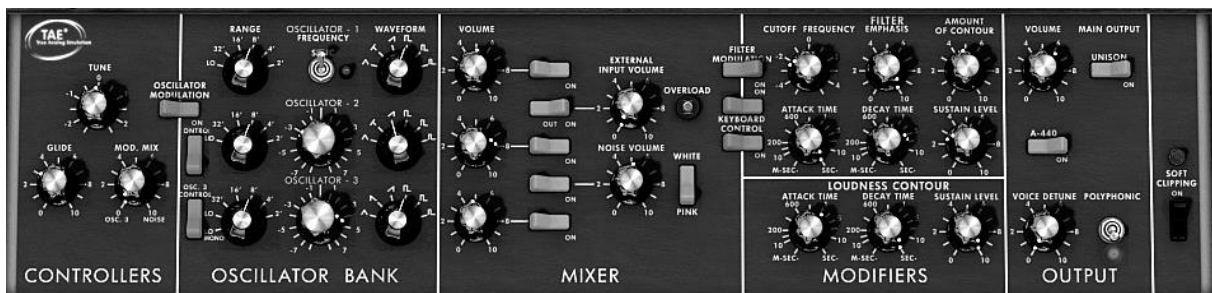

The synthesis parameters

Let's see how to quickly create a progressive lead:

- ▶ To correctly understand the logic in programming the Mini V, let's use a very simple sound. Select the preset "1_Osc" (in the "Templates" sub-bank). The structure of synthesis of this sound is very basic: the sawtooth waveform of oscillator1 is active and the signal is routed through the low-pass filter, and then through the output amplifier.

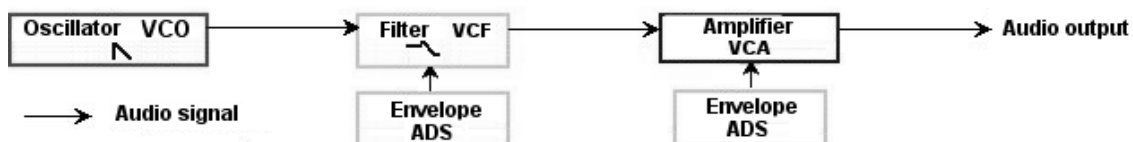

The routing of the sound of preset "1_Osc"

- ▶ Start by lowering the cut-off frequency of the low-pass filter (LPF). This will make the sound more and more dampened.

- ▶ To do this, set the "Cutoff" frequency potentiometer. For fine-tuning, use the right mouse button (this is valid for all potentiometers).

Notice that the filter cut-off is modulated by an ADS envelope (Attack, Decay and Sustain).

- ▶ To clearly hear the effect produced by the ADR envelope on the filter cut-off frequency, increase the resonance ("Emphasis") value 5.00. This will amplify the filtering effect and the sound will start to "whistle".
- ▶ Change the length of attack for this envelope ("Attack time") so that the brightness increases slower or faster when the note is sent.
- ▶ In the same manner, change the value of decay ("Decay time"); the brightness will diminish faster or slower as you hold the note.



The "Attack time" parameter of the filter envelope

You will probably have noticed that an envelope also modulates the amplitude of the sound – "Loudness Contour"

- ▶ Increase the "Attack time" so that the volume of the sound increases progressively.
- ▶ Do the same with the "Decay time"; the volume will progressively decay when you hold the note pressed down.



Amplitude envelope – "Loudness Contour"

3.4 THE "EXTENDED" MODE

When the Mini V is at the "Extended" position, you access an extension panel to the parameters of synthesis. It is displayed in the form of a modulation matrix, a Low Frequency Oscillator (LFO) which was brought in be substituted for oscillator 3 which was being used to this effect. An arpeggiator, a chorus and stereo delay complete this extension.

3.4.1 The modulation matrix

The modulation matrix multiplies the possibilities for editing sound when compared to the original instrument. You can choose 8 sources (sub osc., envelopes, etc.) to modulate 8 destinations (freq. Osc., freq. VCF, etc.).

The choice of source and destination is done via the LCD displays. The matrix offers 15 sources of modulation and 35 destinations (compared to 2 on the original!).



The modulation matrix

3.4.2 The LFO



On the original synthesizer (equivalent to the "Classic" mode), oscillator3 can be set to the low frequency ("Lo" position in the range) to be used in LFO mode. This removed the possibility of using 3 simultaneous oscillators as well as a slow modulation on the filter cut-off frequency for example.

With the added LFO module added in the panel of the "Extended" mode, you can keep the 3rd oscillator as a base for sound and add an additional source of modulation to be used on one of the 35 available locations.

Let's apply 2 additional types of modulation to the "1_Osc" preset:

- ▶ Among the modulation sources, choose the low frequency oscillator ("LFO").
- ▶ Choose the filter cutoff frequency among the destinations. Turn down the frequency so that you can hear the result. The cutoff frequency will vary in a cyclic way, following the LFO oscillations.



Modulation of the filter cutoff frequency by the LFO

- ▶ Between the LCD displays can be found the "Amount" knob. You can set the modulation level by applying positive (turn to the right) or negative (turn to the left) values. For this example, take a value of 0.0480.



Turn the knob to the right to apply a positive value

Let's delay the action of the LFO by applying modulation wheel on its amplitude:

- ▶ Choose the modulation wheel ("Wheel") among the sources.
- ▶ Choose "LFO AM" among the destinations
- ▶ Set the modulation level by applying a positive value of about 0.0193.
- ▶ Set the modulation wheel up to 0.60.

3.5 THE ARPEGGIATOR SECTION

The "Arpeggiator" section lets you easily create an arpeggio from a chord played on the keyboard.

An arpeggio is a series of single notes of the same length that spell out a chord, and play one after the other.

Arpeggiator settings are available on the right of the modulation matrix.

Let's take the example the "JMB_Classic2" preset to see how to use the arpeggiator.

- ▶ Click on the "PLAY" button of the arpeggiator.
- ▶ Play a chord between C4 and C6; the notes will be played one after the other in the order you placed them (it is possible to change the order by clicking on the "mode" button).
- ▶ It is also possible to keep the chord held down by clicking on the "HOLD" button.
- ▶ To remove one or several notes, click again on the "HOLD" button and play the note you want to remove.



The arpeggiator

3.6 THE EFFECTS SECTION

The effects section lets you add chorus or delay to your sound.

3.6.1 The chorus

The Chorus effect enables to double and slightly detune your sound in order to make it deeper and livelier. 3 types of stereo chorus are available.

- ▶ Activate the "ON/OFF" button for Chorus, on the right side of the menu bar.

- ▶ Set the "Dry/Wet" knob for Chorus in order to counterbalance the "raw" sound and the feedback of the effect.
- ▶ Next turn the "Rate" knob to set the speed of the oscillations.
- ▶ Finally set the chorus depth by turning the "Depth" knob.
- ▶ You can choose between 3 types of chorus: Chorus 1, 2 and 3, from the simpler version to a more sophisticated chorus, designed for sharper detuning effects.



Le chorus

3.6.2 The delay

The delay effect adds stereo echoes to the sound.

It has independent settings for the speed and the number of echoes on the right and left sides. It is also possible to create a great number of rhythmic combinations between the echoes. The speed of the delay can also be synchronized with the MIDI tempo.

Let's keep the "JMB_Classic1" preset and see how to use the delay with this sound:

- ▶ Press the "DELAY" button on the toolbar. The effect is enabled.
- ▶ Set the "Dry/Wet" knob of the Delay so as to balance the "raw" bass sound.
- ▶ Next turn the 2 "Speed" knobs of the delay to set the speed of echoes for the right side (Time Right) and left side (Time Left).
- ▶ It is also possible to set the number of echoes on each side ("Feedb. Right" and "Feedb. Left")



Settings of the delay effect

3.7 THE REAL TIME CONTROLLERS AND MIDI ASSIGN

Mini V has been improved in order to provide easier access to MIDI assignment, possibility to save and select multiple configurations.

A default configuration matching Arturia Analog Experience keyboards is loaded at startup. Thus you can control Mini V from Analog Experience keyboards without any configurations.

If you own a non-recognized MIDI controller keyboard, configuration is pretty straightforward:

- ▶ Check that your MIDI controller is recognized (in standalone, if not recognized, you can click Settings to configure MIDI inputs)
- ▶ Click on the button Learn in the toolbar

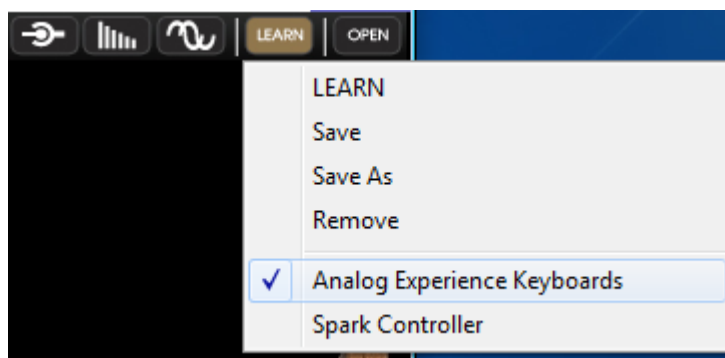

"Learn" menu in toolbar

- ▶ Select LEARN entry, Learn mode is then activated
- ▶ Click on the Cutoff Frequency Knob on the GUI



MIDI assignment popup

A MIDI assignment popup opens, and then just move the control that you want to be assigned. The control is automatically assigned to Cutoff frequency (you can check MIDI control message value).

- ▶ Tweak MIN and MAX sliders to adjust bounds for that control.
- ▶ Repeat this operation for other controls. Notice that you can assign multiple GUI controls to a single hardware control.
- ▶ Click button Learn and select LEARN entry to switch off Learn mode.
- ▶ Click button Learn and select Save As to save your configuration

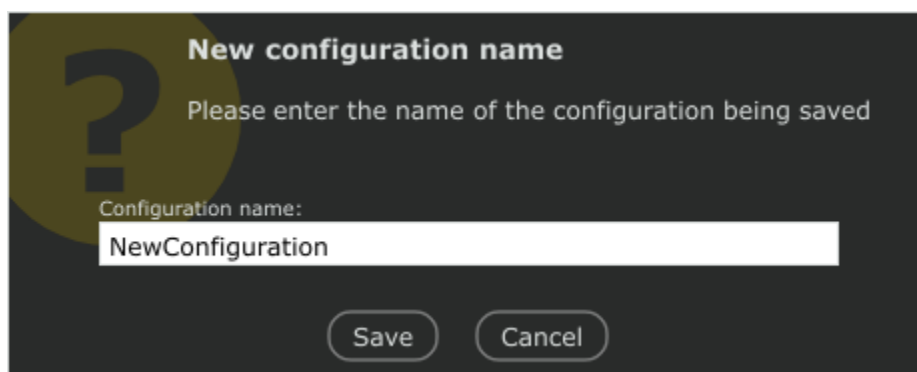

Save As popup

- ▶ Now you can find and quickly reload your newly created configuration in Learn menu

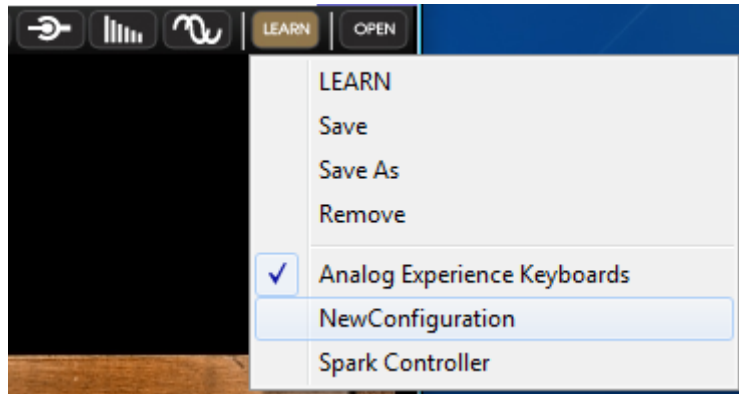

"Learn" menu, recall newly created configuration

4.1 USE OF PRESETS

Presets let you memorize the sounds of the Mini V. A preset contains all of the information pertaining to the reproduction of a sound. In the program, the presets are classed in "banks" and "sub-banks". Each bank contains a certain number of sub-banks, which generally determine a type of sound: sub-bank "basses", sub-bank "sound effects", etc. Each sub-bank contains within itself a certain number of presets.

The Mini V is shipped with several "factory" banks. But it is possible to create new "user" banks of sounds, each containing a number of sub-banks and presets. For security, the "factory" banks cannot be directly modified. It is nonetheless possible to create a sound based on a factory preset by saving it as a "user" preset.

4.1.1 Choice of a bank, sub-bank, preset

The bank, sub-bank and preset in use by the Mini V are permanently displayed in the synthesizer tool bar.

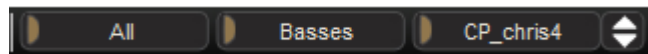

Display of current bank, sub-bank and preset

To choose a preset in the current sub-bank, click on the  button at the right, and a dropdown menu appears with a list of the presets of the same sub-bank. You can choose another preset by selecting the corresponding line in the dropdown menu. As soon as the preset has been chosen, you can play the new sound on your MIDI keyboard or from your sequencer.

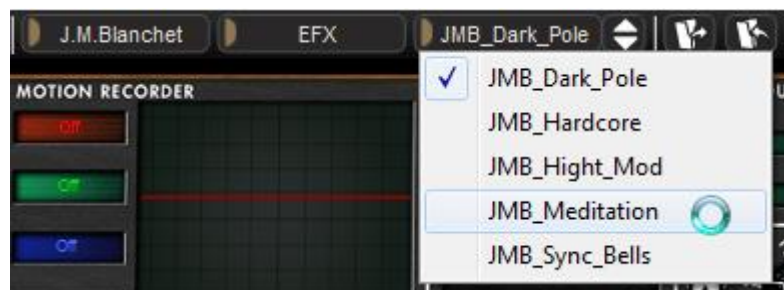

Choice of a preset in the same sub-bank

To choose a preset in the same main bank, but a different sub-bank, click on the  middle button, and a dropdown menu appears with a list of the sub-banks contained in the same main bank. Each sub-bank listed in the menu allows you to open a sub-menu containing its presets. A click on a preset allows you to directly choose a preset in the new sub-bank.



Choice of a preset in another sub-bank

To choose a preset in another main bank, click on the  button at the left. A dropdown menu appears with a list of the main banks available with the sub-banks corresponding to the sub-banks defined in each main bank and to the presets contained in each sub-bank. You can thus freely choose a preset by clicking on its name.

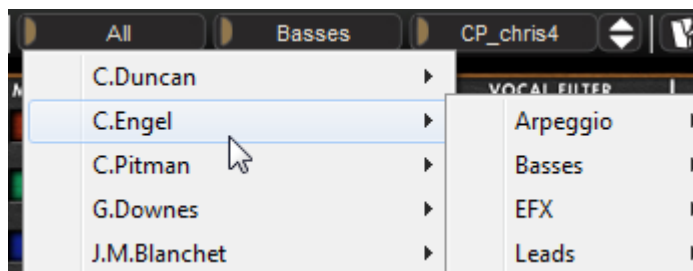

Choice of a preset in another main bank

In the "BANK" dropdown menu, the "All" option allows you to open a sub-list with all of the sub-banks available in all of the banks. This gives you access directly to all of the presets of a given type, for example all of the basses, no matter which bank they are in. This function is particularly useful to quickly see all of the presets of the same type.





Choice of preset regardless of bank

When a preset has been modified an asterisk appears next to its name in the tool bar.

4.1.2 Creation of a bank, sub-bank, preset

To create a new bank, click on the  left button. The dropdown menu displays the names of all of the existing banks of sounds, and a line called "New bank...". Click on "New bank..." to create a new bank of sounds. You can then change the name of this bank by clicking on its name in the tool bar and entering the new name.

To create a new sub-bank, just click on the  middle button, and select "New subbank...". You can also change the name of the new sub-bank.

Finally, to create a new preset, click on the  right button, and select "New preset...". The new preset is created, recording the current settings of the Mini V. You can thus work on the settings of a sound, and save the sound again with the same preset name by clicking on the save button (see the following paragraph). You can also change the title of the new preset by clicking on its name.

4.1.3 Saving a user preset

To save your setting modifications in the current preset, click on the "Save" button in the tool bar of the Mini V.



"Save" button in the tool bar

If you want to save your settings under another preset name, click on the "Save As" button in the tool bar. A dropdown menu appears and lets you choose an existing preset (in this case, the contents of the existing preset will be replaced with the current settings), or to save your settings as a new preset (in this case, click on "New preset..." in the sub-bank of your choice).

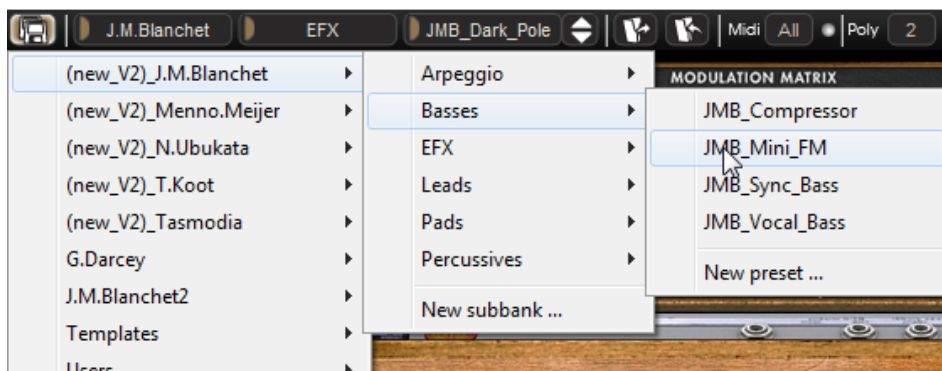

"Save As" button and save menu in the tool bar

When you are working from a factory preset, which cannot be deleted, clicking on the "Save" button will not replace the current factory preset, but will instead automatically open the "Save As" menu to save the current settings as a user preset.

4.1.4 Import/ Export of a bank of presets

It is possible to import new banks of presets conceived for the Mini V. To import a new bank of presets, click on the preset bank import button on the tool bar:



Preset bank import button on the tool bar

When you click on this button, a window will appear allowing you to choose the preset bank file for the Mini V (".minibank" extension). Choose the file that you want to import, and click on "Open". The new bank of presets will automatically appear among the available banks.

The Mini V equally offers the possibility to export your own sounds to save them, to use them on another machine, or to make them available to other users.

It is possible to export a preset, a sub-bank, or a complete bank.

To export the current bank, sub-bank, or preset, click on preset bank export button in the tool bar of the program:

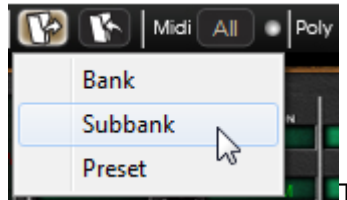

Current preset bank export button in the tool bar

Select the type of export that you want to perform (bank, sub-bank or preset) and a window will appear, giving you access to a choice of destination folder and file name for the bank that you are exporting.

4.2 THE SOUND MAP

The sound map is an innovative preset explorer which offers an easy and funky way to locate and choose a preset on a map area to simplify the preset management and to quickly find the appropriate sounds.

The sound map also offers brand new interface for creating new sounds thanks to a morphing feature between four presets.

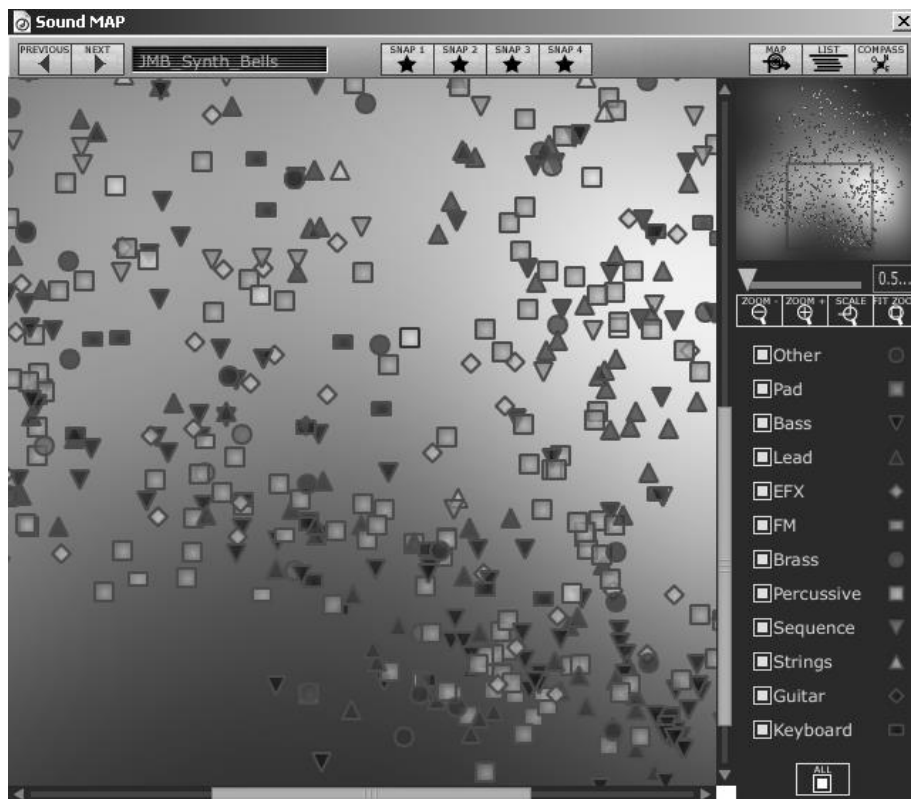

The main interface of the Sound map

The Sound Map offers three options:

The sound map: the sound map classifies the presets thanks to statistic methods in order to organize the sounds on a map from their own audio characteristics.

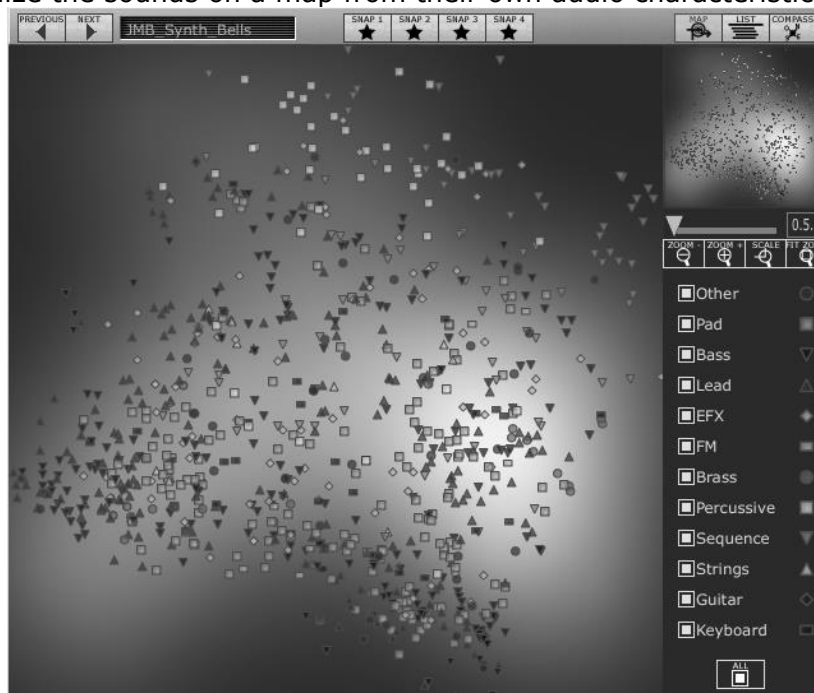

The Map interface

The Presets list: this page offers a more classical interface to classify the presets using lists and filters to find the desired sound.

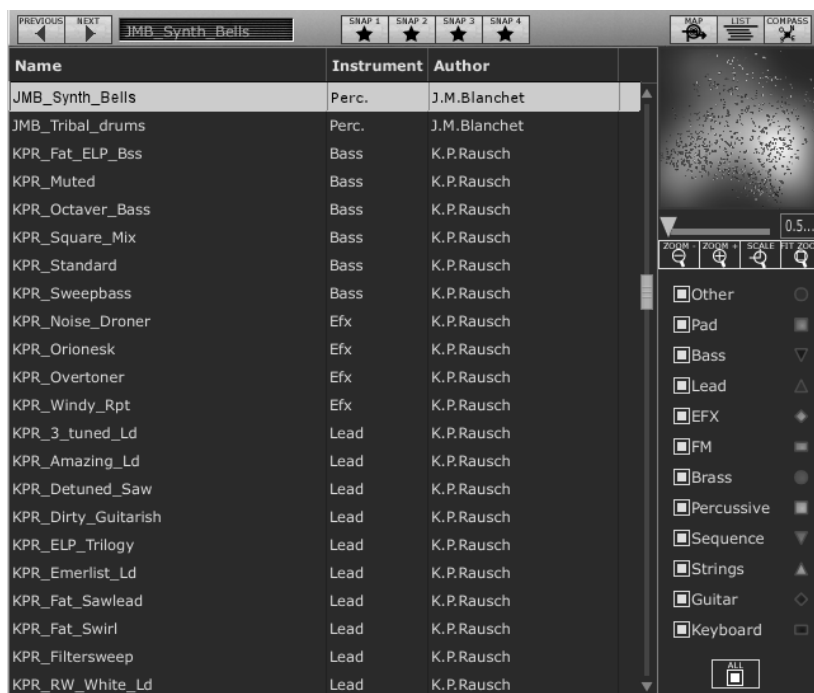

The List interface

The Morphing interface (COMPASS): this page allows creating new sounds in real time thanks to a morphing result between 4 presets.

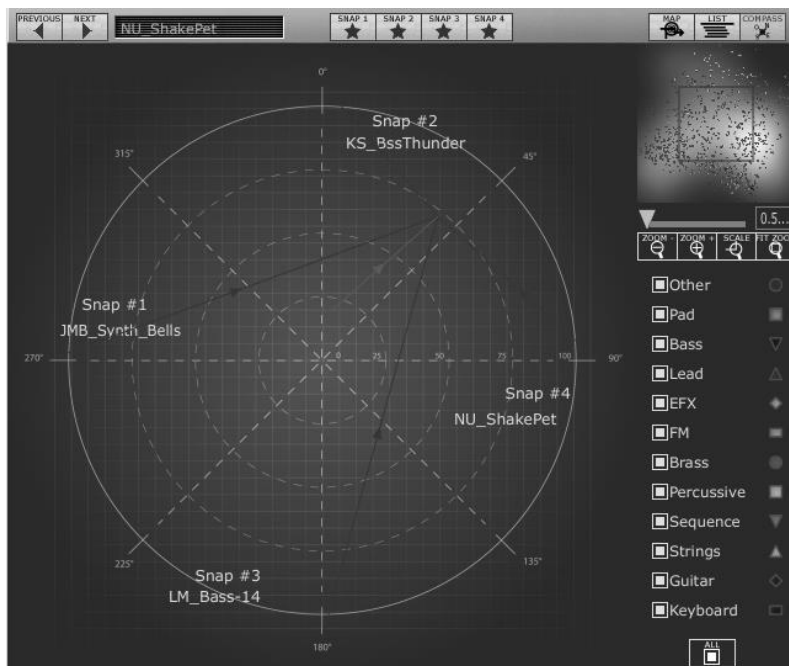

The Morphing interface

Let's go more deeply into the different sound map interfaces...

4.2.1 Opening the sound map

- ▶ To open the main Sound Map interface, click on the "SOUND MAP" button located on the tool bar. A new window appears over the Mini V main interface.



Open the main Sound Map interface

- ▶ To open the preset list page, click on the "LIST" button, on the top right of the sound map interface



Open the List interface

- ▶ To open the preset morphing page, click on the "COMPASS" button.



Open the Morphing interface

- ▶ To return back on the main sound map interface, click on the "MAP" button



Return back on the map interface

4.2.2 The sound map interfaces

4.2.2.1 The sound map main interface

The sound map interface shows a map where are shared out all the presets of the Mini V organized for their types of sound and their own audio characteristics.

The types of presets are represented by different geometrical characters and colours for an easy way to locate them:

- ▼ The "Bass" sounds
- The "Brass" sounds
- ◇ The "EFX" sounds
- The "FM" sounds
- ◆ The "Guitar" sounds
- The "Keyboard" sounds
- ▲ The "Lead" sounds
- The "Pad" sounds
- The "Percussive" sounds
- ▼ The "Sequence" sounds
- ▲ The "Strings" sounds
- The "Others" sounds

- ▶ To select and to listen a preset, directly click on one of the icons, anywhere you want on the map area. The icon is now highlighted in red. If you hold a few seconds on the selected preset, a popup appears and indicates the name of the preset.

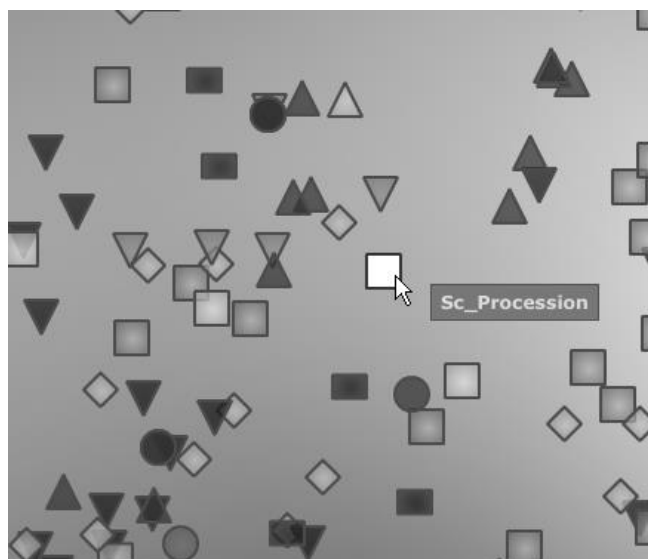

Select a preset

You can create new presets thanks to an exclusive real time morphing feature:

- ▶ Click between a group of presets and hold the left button of the mouse on this point. Four red arrows drawing a cross appear linking the group of four presets.

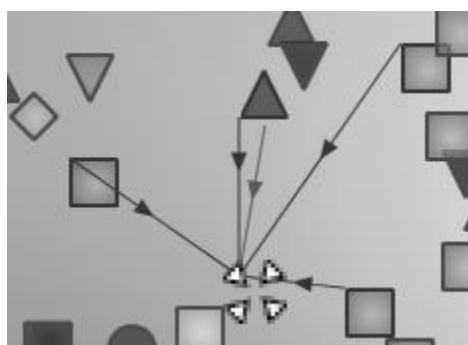

Morphing between a group of presets

- ▶ You can now drag your mouse between those presets. The green arrow shows you the starting point of your motion.
- ▶ When you release the left mouse button, you can play the resulted sound and, if you wish, you can save it on a User bank of the Mini V memory.

By this way it is very easy to quickly get some new and exiting sounds without programming anything on the synthesizer interface.

4.2.2.2 The Sound Map overview

On the top right of the Sound Map main interface, you can see an overview of this map. You can use the map overview for navigating into the map and to zoom in or out inside of the map area.



The map overview interface

- ▶ To navigate into the map, click inside of the red square and drag it on the map area to view other sections of the Sound map.
- ▶ To zoom in the view on the sound map, click on the "Zoom" slider, under the overview window, and drag it on the right to increase the size of the map.
- ▶ To zoom out the view on the sound map, click on the "Zoom" slider, and drag it on the left to decrease the size of the map.



The zoom slider

You can also use the "Zoom +" or "Zoom -" buttons, under the slider, to increase or decrease the map size step by step (by factor 1).

- ▶ Click on the "FIT zoom" button allows resizing the map to its global size.



The FIT ZOOM button

4.2.2.3 The instrument type filter window

On the right of the map main interface, an instrument type filter window allows you to choose which type of preset you want to see (or to hide) on the map. By default, all types of presets are selected.

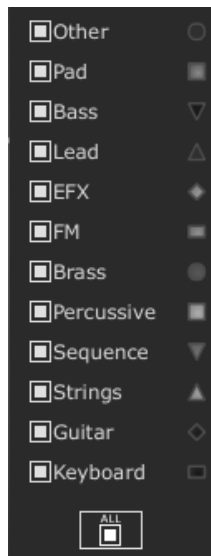

The instrument type filter

To select an individual or a group of instrument types:

- ▶ First click on the "All" button, on the bottom of the type filter window: this will hide all the instrument types from the sound map.



The ALL button

- ▶ Then, select the type(s) you want to see by clicking on the corresponding square box(es). A nock appears on the selected box(es) and the type(s) of presets appears on the map interface.



Show pad presets

This is a good way to simplify and to refine the preset search.

- ▶ If you click again on the "All" button, all the types of presets will be displayed on the map.

4.2.2.4 Preset snap shot memories

You can select up to four presets, anywhere on the map interface, and save them on up to four snap shot memories. You will be able to use those four presets on the "Morphing View" (see below for more details) to create new sounds by morphing feature. Of course, you can save any kind of type of presets on these four snap memories.



Select a snap memory

To save a preset on a snap memory:

- ▶ Select a preset on the sound map main interface.
- ▶ Hold the "Shift" key and select one of the four snap memory button. The snap memory button is now highlighted in red.
- ▶ Repeat the same actions if you wish to save presets on the three other snap memories.

When all memories already contain a saved preset, you can replace them with other presets:

- ▶ Select another preset anywhere on the Sound Map interface, click on any of the 4 snapshot buttons while pressing the Ctrl key.

4.2.2.5 The "Morphing" interface

The "Morphing" page is an independent module allowing you to quickly create some new sounds thanks to a real time morphing from the four selected presets saved on the snap memories.

The four presets are placed on the four cardinal points of the compass.

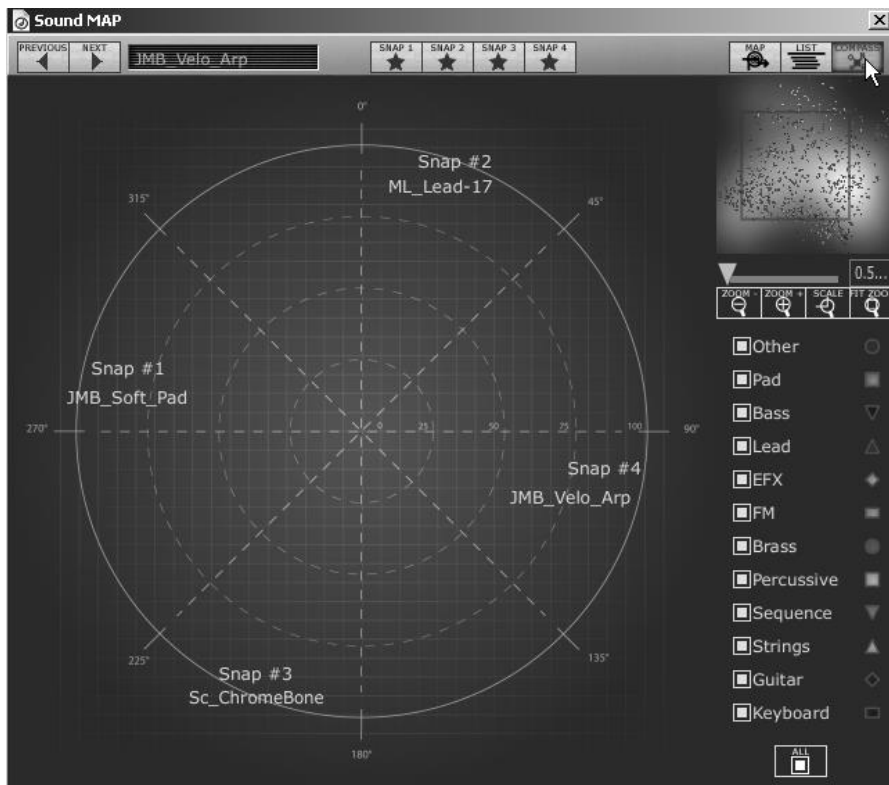

The Morphing interface

- ▶ To open the “Morphing” page, click on the “COMPASS” button, situated on the toolbar of the Sound map.

To create a new morphed sound from those presets:

- ▶ Click everywhere on the center of the compass area (four red arrows appear converging to the group of presets)
- ▶ Hold the left button of your mouse and drag the convergence point until having the good sound.

The green arrow shows you the starting point of your motion.

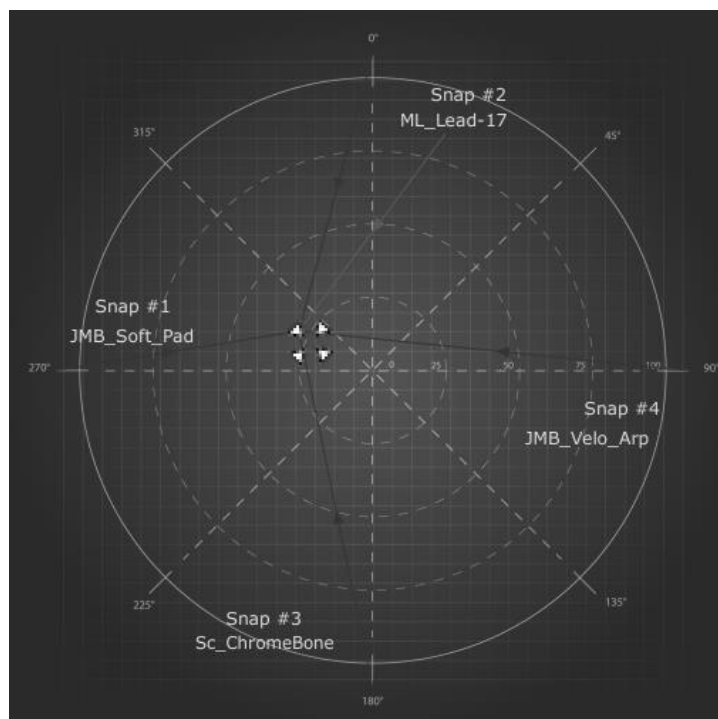

Create a new sound

- ▶ If you wish, you can save it on a User bank of the Mini V memory.

4.2.2.6 The list preset manager

The list preset manager offers a more classical way to explore the presets using a list interface in which the Presets are classified and filtered in order to simplify preset management.

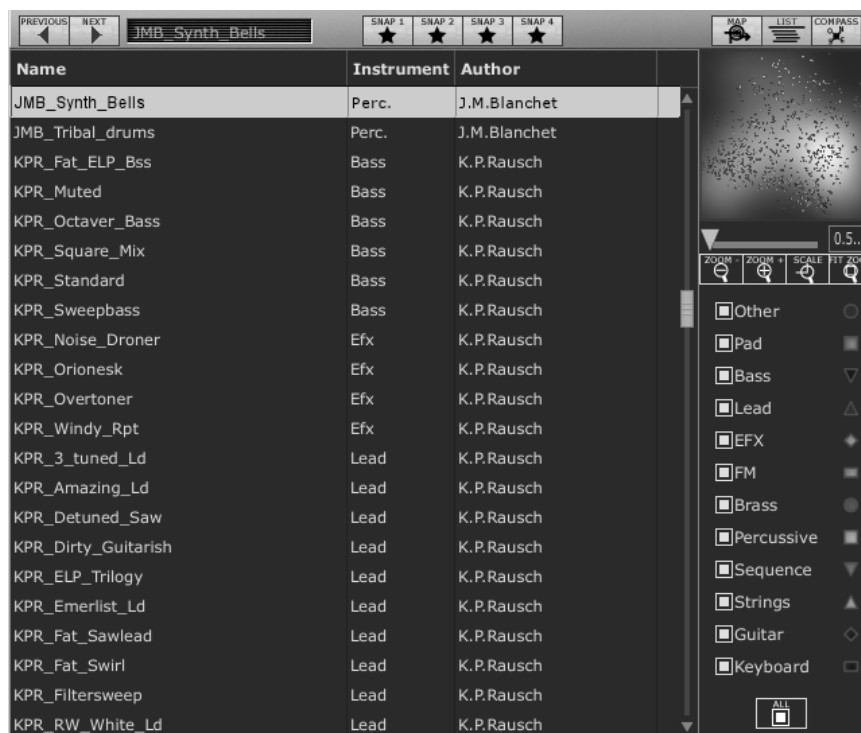

Preset list interface

- ▶ To open the list interface, click on the "List" button, situated on the toolbar of the Sound map.



Click on the "List" button

The list preset interface is very simple: you can see three columns showing, from left to right:

- The preset names
- The instrument type
- The name of the sound designers

All those data are classified by alphabetical order.

- ▶ To select a preset, simply browse the list and click on the name of a desired preset.
- ▶ You can inverse the order (from A to Z or from Z to A) by clicking on the column title: an ascendant or descendant arrow shows you the order type.

Instrument	Author
Bass	C.Duncan
Bass	C.Duncan
Bass	C.Duncan
Bass	C.Duncan
Bass	C.Duncan
Bass	C.Duncan
Bass	C.Duncan
Bass	C.Duncan
Bass	C.Duncan
Bass	C.Duncan
Bass	C.Duncan
Bass	C.Duncan
Bass	C.Duncan
Bass	C.Duncan
Bass	C.Duncan

Inverse the order of the instrument types

4.3 USE OF CONTROLLERS

The Mini V uses different types of controllers: potentiometers, switches, wheels, etc. Let's take a look on those different types of controllers:

4.3.1 Potentiometers

Generally the sequencers offer several potentiometers control modes. The default mode of control for knobs with the mouse is the circular mode: click on the knob and turn around it in order to change the value of the controller. The circular mode gives high precision in the manipulation of controls: The further the mouse goes from the knob, the higher the precision of the setting.

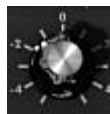

Potentiometer

In linear mode, the knob can be set only by vertically moving the mouse, not going around it. Like the sliders, it is possible to obtain a higher precision by right clicking or Shift+Click on the knob concerned.

The linear mode can sometimes be simpler to use than the circular mode, although we can lose in precision (the precision is limited by the number of vertical pixels on the screen on which the mouse movements are being evaluated). Movement to linear mode is available in the options of your sequencer. In Cubase™, for example, this choice can be found via the "Edit/Preferences" menu, and is found in the "General" tab of the window.

4.3.2 Switches

The Mini V has several types of switches. Simply click on these switches to change their state.



Switches

4.3.3 Pitch Bend wheel

The pitch bend wheel is used to change the pitch of the oscillators. Just click on the wheel and move the mouse up or down to change the pitch of your sound. The wheel goes back at the center position when the mouse is up.



The pitch wheel

4.3.4 Virtual keyboard

The keyboard lets you listen to the synthesizer sounds without the need for an external master MIDI keyboard, and without programming a melody in the sequencer. Just click on a virtual key to hear the corresponding sound.

4.3.5 MIDI control

Most of the knobs, sliders and switches on the Mini V can be manipulated with external MIDI controllers. Before anything else, make sure that the MIDI device that you wish to use is correctly connected to the computer, and that the sequencer or the Mini V application is correctly configured to receive MIDI events coming from the device.

4.3.5.1 Learn menu

A new menu entry has been introduced in Mini V. This menu entry "Learn" provides access to MIDI assignment functionalities.

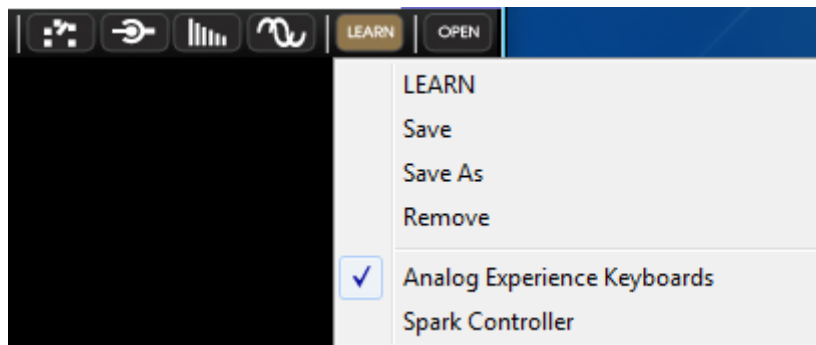

"Learn" Menu

The "Learn" Menu is composed to 2 sections:

First section provides Learn mode activation or deactivation

- ▶ First section provides
 - "Learn" Mode activation and deactivation
 - "Save" current configuration
 - "Save As" current configuration to a new one
 - "Remove" current configuration from list
- ▶ The second section contains the list of existing configurations
 - The ticked one is the current one
 - Click on one configuration to load it

4.3.5.2 Assigning MIDI controls

In order to start assigning MIDI controls, click "Learn" menu, then "LEARN" entry. The entry menu button remains highlighted to indicated that the "learn mode" is ON.

Click on a control of the GUI to open MIDI assignment popup.

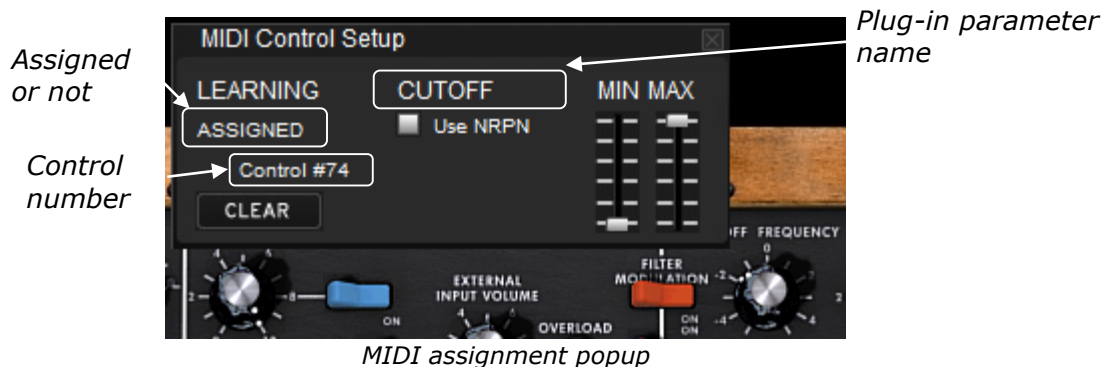

- ▶ Learn assignment

First and most easy going way to assign a control is to move it to be recognized by Mini V.

- ▶ Hand assignment

It is also possible to change the assigned MIDI control number by clicking on Control#xx and select another value.

- ▶ Support for NRPN

In addition to MIDI Control Change messages, NRPNs are now supported: either send NRPN MIDI control messages to Mini V, or check NRPN, then select LSB# and MSB# numbers:

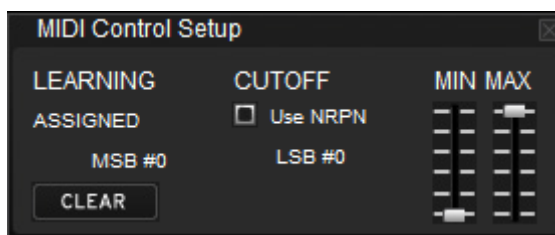

MIDI assignment popup, NRPN activated

- ▶ Remove assignment

Assignment can be removed by clicking "Clear" button. The message "Not assigned" will then be displayed.

All these operations deal with a single plug-in parameter. In order to setup a complete configuration, a set of parameters should be configured.

4.3.5.3 Manage configurations

New in Mini V: the possibility to maintain multiple configurations.

- ▶ Default configuration

By default, Mini V loads configuration for Arturia Analog Experience keyboards.

- ▶ Select one configuration

A configuration is loaded by clicking the entry in "Learn menu".

- ▶ Create a new configuration

A new configuration can be created by performing assignment operations described in the previous section. This configuration has then to be saved by clicking on "Learn menu", "Save As" entry. A popup opens, enter the name of your configuration. A new entry for your configuration now exists in the list of available configurations.

- ▶ Remove a configuration

It is possible to remove a configuration by loading on and click on "Remove".

4.3.5.4 Minimum and maximum bounds

For each assignment, a minimum bound value and a maximum bound value can be set. This means that:

- ▶ Assigned parameter will have the configured minimum value when the controller will be at its lowest position
- ▶ Assigned parameter will have the configured maximum value when the controller will be at its highest position
- ▶ You can invert Min and Max so that parameter will have minimum value when control has the highest value, and parameter will have maximum value when control has the lowest value

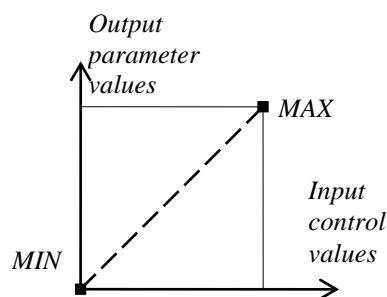

DEFAULT

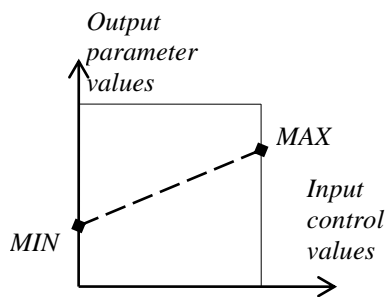

POSITIVE SLOPE

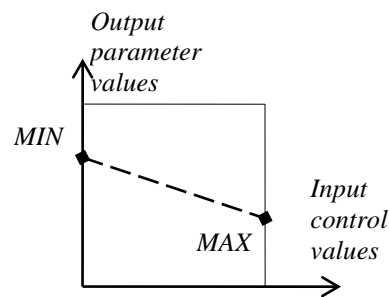

NEGATIVE SLOPE

$$\text{parameter_value} = \text{MIN} + (\text{MAX} - \text{MIN}) * \text{control_value}$$

4.3.5.5 Multiple assigned parameter

It is possible to assign and setup assignment for multiple parameters to a single control.

- ▶ Activate "Learn" mode, select a parameter (GUI control)
- ▶ Tweak control to assign it (optionally setup minimum and maximum)
- ▶ Select a second parameter
- ▶ And tweak the same control
- ▶ Deactivate "Learn" mode

Tweaking assigned control should modify both parameters with regards to assignment setup (Min, Max).

4.3.5.6 Tricks

- ▶ Oscillator 2 and 3 tune control 2 parameters: FINE and COARSE. If "Learn" mode is ON, clicking on control provide access to assignment of FINE parameter, shift+clicking on control provides access to assignment of COARSE parameter.

When it is set to "Classic" mode, the Mini V remains very close to the original synthesizer. It is composed of two parts, one containing the synthesis parameters, the other being the keyboard and the modulation wheels. The synthesis panel is separated into several sub-groups, corresponding to the usual modules for subtractive synthesis: Oscillators, Mixer, Filter and Envelopes.



View of the Mini V in "Classic" mode

By clicking on the "Open" button of the toolbar or the upper wooden bar, the Mini V will open and reveal the extension panel. The effects, an arpeggiator and a modulation matrix are contained here.



View of the Mini V in "Extended" mode

5.1 THE OSCILLATORS

The Mini V has three independent oscillators which can be found in the "Oscillator Bank" section in the synthesis panel.

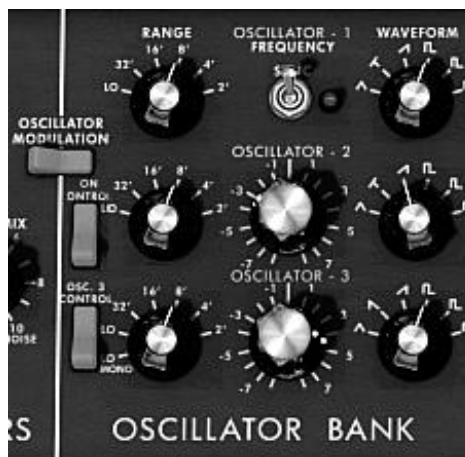

Oscillators

Each of these oscillators can produce different waveforms which are selected using the knob on the right. The first two generate, from left to right, a triangle, an asymmetric triangle, an ascending sawtooth, a square, asymmetric square and impulse. The third oscillator replaces the asymmetric triangle with a descending sawtooth. By right clicking on these selectors, it is possible to adjust the impulse width of certain waveforms: square, rectangular, impulse, triangle and asymmetric triangle. If the waveform is again modified, the impulse width will go back to its default value.

The choice of range for these oscillators can be set with "Range" knobs on the left. From the left to right are the positions: Low, 32, 16, 8, 4, and 2, the third oscillator adds the "LowMono" position at the extreme left.

The "Low" position corresponds to a very low frequency mode, the position "LowMono" on the third oscillator adds a monophonic function. In this mode, the oscillator will generate the same signal irrespective of the note played, unlike the "Low" mode where it generates a different signal for each of the notes in polyphonic mode.

The other positions of this knob correspond to the range, the 8 position being the position without transposition, positions 4 and 2, respectively 1 and 2 octaves above, positions 16 and 32 respectively 1 and 2 octaves below.

Oscillators 2 and 3 can equally be fine tuned with the central "Frequency" knob. By left-clicking with the mouse on the knob, the setting is done by semi-tone, by up or down an octave, while when right-clicked, it is possible to tune it in a continuous manner, by more or less a semi-tone. By double clicking on this knob, it is possible to set it to its default value, which is to say tuned.

- The "**Sync**" switch synchronizes oscillator 2 with oscillator 1. In this position, it is the tuning of oscillator 1 which will be evident while oscillator 2 will bring and modify the harmonics heard.
- The "**Osc. 2 Control**" switch allows to activate and deactivate the command of oscillator 2 by the keyboard.
- The "**Osc. 3 Control**" switch is for activating and deactivating the command of oscillator 3 by the keyboard.
- The "**Oscillator Modulation**" switch modulates oscillators 1,2 and 3 via oscillator 3 with an amplitude depending on the modulation wheel. If we don't want to have oscillator 3 modulate itself, we need to deactivate the switch.

5.2 THE MIXER

The section situated on the right of the "Oscillator Bank" sub-group mixes the different signals available before applying the filtering.



Mixer

There are five sound sources available: the three oscillators, a noise generator and external audio in. The level of the three oscillators is set with each of the "Volume" knobs, the external signal level with the "External Input Volume" knob, the noise level with the "Noise Volume" knob. The five vertically aligned switches allow the quick

deactivation of a given sound source, while the “White/Pink” switch selects a white or pink noise.

When the “Overload” indicator lights up, this indicates an overload of the external audio in.

The mixer possesses two modes of functioning, with or without the emulation of the overload circuit. In the first case, the sound signals are not modified regardless of their level. In the second, the overload circuit limits the amplitude and thus allows a modification of the tone typical of the original model.

The mixer mode change is done with the “Soft Clipping” switch on the extreme right of the synthesis panel.

It should be noted that the emulation of the overload circuit is heavy on calculation power, and using it should be avoided with heavy polyphony or unison.



Activation of the overload circuit (soft clipping)

The switch corresponding to the external signal has three positions. The first disconnects this input from the mixer. The second position connects the output of the Mini V to the mixer. This allows, thanks to the particular distortion brought by the overload circuit, to obtain a typical sound. The third connects the external input to the mixer.

5.3 THE FILTER AND ITS ENVELOPE

The result of the mixing of different sources of sound is directed towards a resonant filter with a slope of 24dB per octave.



Filter parameters

The “Cutoff frequency” knob sets the cut-off frequency. The “Emphasis” knob sets the level of resonance and “Amount of Contour” the action of the envelope generator associated to the filter.

It should be noted that this filter auto-oscillates, which is to say that when the resonance is set to the maximum, the filter generates a signal close to sinusoid even in the absence of an input signal. Nonetheless, a weak noise signal as filter input brings us a little closer to the results obtained with the original synthesizer. In fact, electronics can never guarantee a perfect zero level to the filter input as is the case with a virtual reproduction.



Envelope generator associated to the filter

The envelope generator associated to the filter can be adjusted with the “Attack Time” knob for the attack time, and the “Decay Time” knob for the decay time, and the “Sustain Level” knob for the level of sustain.

Unlike other envelope generators, there is no separate setting for the time to return to zero. This time is the same as the decay time but can be activated or deactivated with the “decay” switch situated on the left of the keyboard. When it is deactivated, the return time to zero for the generator is practically zero.

The two “Keyboard control” switches allow the use of a key follow at the filter cut-off frequency.

- When they are set to the “OFF” position, no key follow is connected.
- When the first is “ON”, the key follow allows the modification of the cut-off frequency by a major third for an octave.
- When the second is “ON”, the key follow is of a fifth for an octave, and when both are “ON”, the filter cut-off frequency exactly follows the keyboard. It should be noted the pivot note is F0.

A supplementary key follow can be connected with the modulation matrix. These two key follows combine. The key follow connected by the modulation matrix has a maximum slope of two octaves, which can be set with the amount knob of the matrix.

When a key follow is connected, the cut-off frequency is equally influenced by portamento, when it is active.

5.4 THE OUTPUT VOLUME AND ITS ENVELOPE

The output level of the Mini V is managed by a voltage controlled amplifier (VCA) where the setting changes are made with the “Volume” knob in the “Output” group of the synthesis panel.



Setting the output level

This VCA is also controlled by an envelope generator which is set in the same manner as the envelope generator associated to the filter.



Parameters of the envelope generator associated to the VCA

This envelope generator is set with the "Attack Time" knobs for the attack time, and the "Decay Time" knob for the decay time, and the "Sustain Level" knob for the level of sustain. The management of the return to zero is identical to the envelope generator associated to the filter.

When the decay time knob is set to the maximum, the notes are held indefinitely.

5.5 THE POLYPHONIC MODE, THE PLAYING MODES

The original model was a monophonic synthesizer. The Mini V offers the possibilities of polyphonic playing where the number of voices can be set from 2 to 32 with the "Voices" menu.

The "**Unison**" switch: lets you to play all of the voices at the same time. The "Voice detune" knob lightly detunes each of the polyphonic voices.



Number of polyphonic voices and playing mode

The "**Polyphonic**" switch: activates or deactivates the polyphonic playing mode. When deactivated, the Mini V is in monophonic mode. When more than one note is played on the keyboard, the note that will be heard depends on the mode of playing selected in the "playing mode" menu.



Polyphonic and unison

In "Low" mode we will hear the lowest note, in "High" mode the highest note, and in "Last" mode the last note played on the keyboard.

In the two first modes, when the note is released, we will hear the lowest note (or respectively the highest) without triggering the envelopes. In the last mode, the envelopes are always active.

It is possible to prevent the triggering of envelopes with the "Legato" switch which is on the left of the keyboard.



Activation of the Legato mode

The original synthesizer uses the "Low" playing mode when the "Legato" mode is activated.

The notes played on the keyboard directly command the frequency of the oscillators. Nevertheless it is possible to move this frequency slowly from one note to the next. This function, called portamento, is activated with the "Glide" switch on the left of the keyboard.



Activation of the portamento

The "Glide" knob: sets the time taken to reach the note played.



Setting the portamento time

The "Glide" switch: activates or deactivates the glide. It can be controlled by a foot switch pedal. In this case you must click on the jack on the left.

The same is true for the "Decay" switch activating the time for the return to zero of the envelopes.



Activating the portamento and return to zero of the envelopes by pedal

When none of the jacks are connected, eventual pedal commands act on the notes sustain.

5.6 THE PITCH BEND AND MODULATION WHEELS

On the left of the keyboard we find two wheels, one for modifying the oscillator frequency, the other for varying the amplitude of the modulation brought by the third oscillator, either on the oscillator frequency, or the filter cut-off frequency.

When the modulation wheel is at zero, the window displays "no modulation". This means that it is not possible to modulate the value given by this wheel with the modulation matrix (see underneath).

On the left of the bend wheel we find a "BEND" switch and a "RANGE" potentiometer.

The "BEND" switch is used to disconnect the bend wheel from the frequency of the oscillators. We can thus, through the modulation matrix, use the bend wheel to modify a parameter of synthesis, without modifying the frequency of the oscillator.

The "RANGE" potentiometer sets the amplitude of the bend wheel, more or less four octaves per semi-tone.



Setting the bend wheel

5.7 THE MOTION RECORDER

The Motion Recorder allows recording in real time some parameters motions on the fly. Four dedicated tracks containing each one parameter motion are available. Those recording curves can be quantized to a MIDI tempo or not.

The different motion curves can also be "manually" modified thanks to a dedicated edition interface including drawing tools (pen, rubber, curve, lines...)



The Motion Recorder main interface

5.7.1 The Motion Recorder activation/deactivation

- ▶ To activate the Motion Recorder, just click on the "MOTION" button, situated on the tool bar. (This button is now highlighted)



The "MOTION" button

- ▶ To deactivate the Motion Recorder, just click on the "MOTION" button (This button is now extinct).

5.7.2 Playing recorded Motion curves

To hear the complete motion curve, you have to hold a note (or a chord) on your MIDI keyboard or on your MIDI sequencer.

- ▶ To play one (or several) recorded motion curves, select the desired motion track to be read by clicking on its dedicated "☐" button.
- ▶ Play one (or several) note(s) on your MIDI keyboard to read the motion curve(s).
- ▶ To stop the curve playing, you can deactivate the modulation destination by selecting the "OFF" option in the automation track.

The motion automation curves are re-triggered each time a note will be played. Finally, they can be equivalent to "super envelopes" that are drawn by the user!

5.7.3 Recording a parameter motion curve in real time

- ▶ Activate the live recording mode by clicking on the " >>> " button, situated on the Mini V tool bar. (This button is now highlighted).
- ▶ Play a note on your MIDI keyboard and hold it during the recording time. The recording is now starting.
- ▶ Choose the parameter you wish to automate by clicking on the dedicated potentiometer.
- ▶ Tweak this potentiometer as you wish during the recording.

The motion recording stops by itself automatically after thirty seconds. (The " >>> " button switches off)

- ▶ To stop the recording before its time limit, simply release the playing note.

The parameter you have automated is now selected on the LCD parameter screen of the active track and the result of the recording curve is displayed on the Motion Recorder main screen.

- ▶ You can also change the parameter on the fly over the old one by clicking on another potentiometer. You can also select a new parameter on the destination parameter menu situated on the left of the Motion Recorder main screen.

5.7.4 Erasing a recorded automation in real time

Erasing a recorded automation is very easy:

- ▶ You just have to record again new motion automation by the same way as describe above. The new motion will automatically take the place of the old one and will be displayed on the Motion Recorder main screen.

5.7.5 Quantizing a motion curve

The Motion Recorder allows you to quantize a recorded motion curve in relation to the internal Mini V tempo or to a host MIDI tempo.

- ▶ Click on the "QTZ" menu, situated under the Motion Recorder main screen and select the quantization factor you wish on the dedicated menu.



Click on the "QTZ" menu

Some steps appear on the curve according to the chosen quantization.

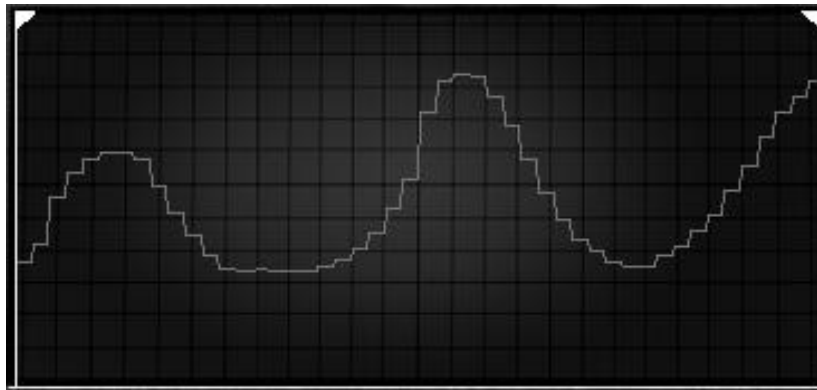

Steps appears on the motion curve

Those steps on the motion curve can bring some interesting rhythmic grooves or some sample and hold effect if you use the Square tool available on the "Edit" interface. (See below for more details about the edit tools)

5.7.6 Setting the modulation amount of a motion curve

You can set the output modulation amount for each motion curves to refine the modulation results as you wish.

- ▶ Select the desired motion track thanks to the "☐" button.
- ▶ Click on the amount potentiometer (labeled "AMT") situated under the Motion Recorder main screen and set the desired amount of modulation.



Click on the amount potentiometer

5.7.7 The parameters available for the Motion Recorder

The parameters available as modulation destinations for the Motion Recorder are:

- VCO1 FM Coarse frequency of oscillator 1
- VCO1 PWM Pulse width of oscillator 1
- VCO1 AM Output level of oscillator 1 (available in the Mixer)
- VCO2 FM Coarse frequency of oscillator 2
- VCO2 PWM Pulse width of oscillator 2
- VCO2 AM Output level of oscillator 2 (available in the Mixer)
- VCO3 FM Coarse frequency of oscillator 3
- VCO3 PWM Pulse width of oscillator 3
- VCO3 AM Output level of oscillator 3 (available in the Mixer)
- VCO12 FM Coarse frequency of oscillators 1 and 2
- VCO123 FM Coarse frequency of oscillators 1, 2 and 3
- VCO12 PWM Pulse width of oscillators 1 and 2
- VCO123 PWM Pulse width of oscillators 1, 2 and 3
- VCO12 AM Output level of oscillators 1 and 2
- CutOff Filter cut-off frequency
- Emphasis Level of filter resonance
- EG VCF lev Amount of filter envelope
- EG VCA lev Amount of amplifier envelope
- Glide Portamento time
- MixMod Balance between oscillator 3 and noise
- Mod.Wheel Amount of internal modulations only (oscillator and filter)
- VCA AM VCA output level
- LFO FM LFO speed
- LFO AM LFO amplitude
- Noise AM Output level of noise generator (available in the Mixer)

- Ext. AM Level of the audio external input (available in the Mixer)
- Pan Mod Panoramic
- Vocal Filter X Vocal Filter X movement
- Vocal Filter Y..... Vocal Filter Y movement
- Off..... No modulation destination

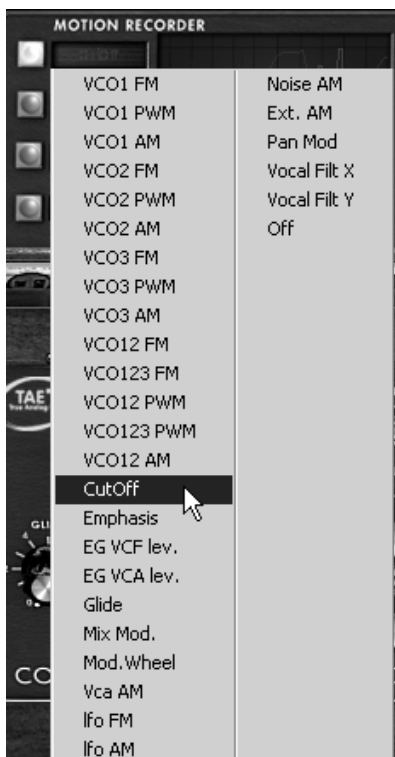

Choose a modulation destination

5.7.8 Editing a motion curve

You can edit in real-time your motion curves thanks to the dedicated "CURVE EDITOR" interface. This editor includes an ensemble of tools which will help you to draw or erase a part or the whole of the selected curve.

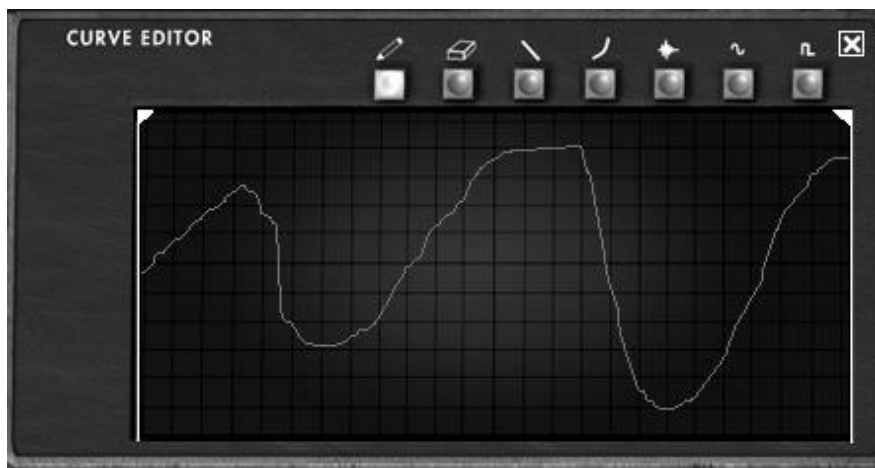

The "CURVE EDITOR" interface

Let's take a look on the "Curve Editor" interface:

5.7.8.1 The Edit tools

- Drawing tool Tool for drawing a freehand curve.
- Eraser tool..... Tool for erasing an existing curve.
- Line tool..... Tool for drawing a straight line.

- Curve tool Tool for drawing an exponential curve.
- Noise tool Tool for adding noise to an existing curve.
- Sine tool..... Tool for drawing a sinusoid.
- Square tool..... Tool for drawing a square curve.



The Curve Editor tools

5.7.8.2 The Curve Editor screen

The Curve Editor screen allows you to edit a recorded curve or to draw a new curve from scratch.

- ▶ To open the Motion Recorder screen editor, click on the middle of. A new bigger screen is now opened showing the current motion curve.

Two locators bars determine the input and output loop points of a recorded curve.

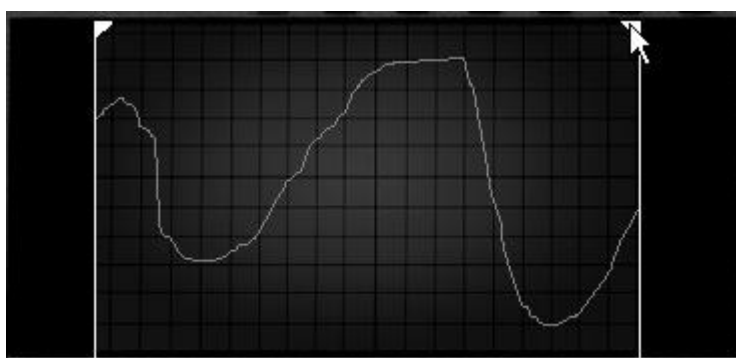

Place the right locator

- ▶ To place a locator, click on the left top arrow (for the input point) or on the right top arrow (output point) and drag it from left to right to choose the desired input or output points of the loop.
- ▶ Click on the "Loop" interrupter to validate the loop mode.



Click on the "Loop" interrupter

If you have chosen a quantization factor (1/8 for example), the locators will move by steps thru this quantization factor.

5.8 THE VOCAL FILTER

The Vocal Filter is a formant filter which can be applied to the output signal of the Mini V or to an external audio signal.

The main interface of the Vocal filter, located on the central TV style screen, shows an ensemble of five vowels (A, E, I, O and U).



The main interface of the Vocal Filter

The Vocal Filter frequency can be set in real time:

- ▶ Manually by moving the red ball cursor between five vowels or moving the vowels letters by dragging them on the screen surface of the Vocal filter.

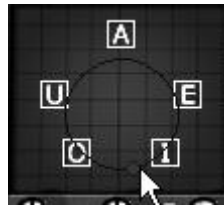

Manually moving the red ball cursor

- ▶ An LFO is also available to make an automation of the cursor movements.
- ▶ You can set the radius amplitude of the LFO by clicking on the red ball cursor and moving it out of its central initial place. This action will set the width of the circle of the ball movements.
- ▶ It's also possible to re-arrange the order of the five vowels on the screen space. To do this, simply click on one of the 5 letters and drag it on the place you wish on the screen. Those changes will introduce some interesting variations when you will modulate your five filters manually or with the LFO.



Re-arrange the order of the vowels

On the bottom of the main screen, three potentiometers and a button allow setting additional parameters as follow.



The Vocal Filter parameters

From left to right:

- Gain Sets the balance between the dry signal coming from the Mini V (or from an external audio source) and the vocal filter signal.
- Q..... Sets the band width of the 5 band pass filters of the Vocal Filter. At the right top, it result a very thin audio signal close to a whistle sound.
- LFO Sets the rate of the Vocal Filter LFO
- "□" button..... Start or stops the LFO activity

5.9 THE LOW FREQUENCY GENERATOR

The Mini V brings a new module which allows the generation of a very low frequency to modulate any off the synthesis parameters. It is situated in the extension panel which appears the Mini V is in open position.



Low frequency generator

- "Rate" knob Sets the frequency, the "Waves" knob selects the waveform,
- "Midi Sync" switch ... Synchronize the frequency of the generator to the tempo of the host application.
- Waveforms Sinus, descending sawtooth, ascending sawtooth, square, noise, random, triangle.

The modulation destinations for the LFO generator are selected exclusively through the Modulation Matrix (see below)

5.10 THE MODULATION MATRIX

The Mini V increases the original possibilities of modulation thanks to the presence of the modulation matrix in the extension panel. This panel appears when the Mini V is in open position.



Modulation matrix

This matrix can be activated or deactivated with the selector in the task bar above the synthesizer.



Activation of the modulation matrix

The matrix allows 8 modulation connections. To activate a connection, select a source of modulation by clicking in the "source" zone, next select a parameter to modulate in the "destination" zone, and set the rate of modulation with the "Amount" knob.

The sources of modulation are:

- VCO3 Output of oscillator 3
- EG VCF..... Filter envelope output
- EG VCA VCA envelope output
- P.Bend Pitch Bend wheel
- ModWheel..... Modulation wheel
- AfterTouch..... Polyphonic aftertouch / Channel pressure
- FootExp..... Expression pedal
- Velocity Velocity
- LFO..... LFO output
- Kbd Follow..... Key follow output
- Ext. In External input signal
- VCA out..... VCA output signal

- Voice Num..... Gives a different fixed modulation value for each voice number (voice) played
- Triggered SH1..... Fixed random modulation value for each note played
- Triggered SH2..... Fixed random modulation value for each note played
- Off No source of modulation

The parameters that can be modulated are:

- VCO1 FM Frequency of oscillator 1
- VCO1 PWM Impulse width of oscillator 1
- VCO1 AM..... Output level of oscillator 1
- VCO2 FM Frequency of oscillator 2
- VCO2 PWM Impulse width of oscillator 2
- VCO2 AM..... Output level of oscillator 2
- VCO3 FM Frequency of oscillator 3
- VCO3 PWM Impulse width of oscillator 3
- VCO3 AM..... Output level of oscillator 3
- Noise AM Output level of noise generator
- Ext. AM Level of the audio external input
- CutOff..... Filter cut-off frequency
- Emphasis..... Level of filter resonance
- EG VCF Att. Attack time of filter envelope
- EG VCF Dec. Decay time of filter envelope
- EG VCF Sus. Sustain level of VCA envelope
- EG VCF Lev..... Output level of VCA envelope
- EG VCA Att. Attack time of VCA envelope
- EG VCA Dec..... Decay time of VCA envelope
- EG VCA Sus. Sustain level of VCA envelope
- EG VCA Lev Output level of VCA envelope
- Glide..... Portamento time
- MixMod Level of mixing between oscillator 3 and the noise
- Mod.Wheel Level of the modulation wheel
- VCA AM..... VCA output level
- LFO FM..... VCA speed
- LFO AM Level of LFO output
- Osc1-2 FM Frequency of oscillators 1 and 2
- Osc1-2-3 FM..... Frequency of oscillators 1, 2 and 3
- Osc1-2 PWM Modulation of the impulse width of oscillators 1 and 2
- Osc1-2-3 PWM Modulation of the impulse width of oscillators 1, 2 and 3
- Osc1-2 AM..... Modulation of the amplitude of oscillators 1 and 2
- Pan..... Modulation of the output panoramic
- Vocal Filter X Modulation of Vocal Filter X movement
- Vocal Filter Y..... Modulation of Vocal Filter Y movement
- Off..... No destination of modulation

5.11 THE ARPEGGIATOR

Situated in the Mini V extension panel which appears when in “Extended” mode, the arpeggiator allows for each note the activation of an arpeggio.



Arpeggiator

The “**Speed**” knob sets the speed of the arpeggio.

The “**Midi Sync**” switch lets you synchronize delay return time with the host application.

The **“Play”** switch triggers the arpeggiator which, when a note is played, activates the notes one after the other, and stops when there are no more active notes on the keyboard.

The three state **“Off/Hold/Mem”** switch lets you choose the arpeggiator mode: In **“Mem”** position, the notes played on the keyboard are memorized. To stop the memorization, place the switch to **“Off”** mode.

To stop the chaining of the notes, you must stop the arpeggiator with the **“Play”** position. In the **“Hold”** position, the notes played on the keyboard remain present until a new note (or group of notes) is played.

As long as a note remains active on the keyboard, all of the notes played are memorized.

The **“Mode”** selector is used to choose the arpeggio mode: ascending, descending, return, random, and in the order of appearance of the notes.

The **“Octave”** selector is used to choose the number of octaves that the arpeggiator cover for each cycle. The **“Repeat”** selector is used to choose the number of cycles repeated for each octave.

5.12 THE CHORUS AND STEREO DELAY

In the Mini V extension panel which appears when it is in open position, we find two effects, chorus and stereo delay.



Chorus and stereo delay

The chorus has three knobs: **“Rate”** **“Depth”** and **“Dry/Wet”** which respectively set the speed, the depth and the relationship between the original signal and the modified signal. The **“type”** buttons allow the selection of chorus types, from the simplest to the deepest. The delay contains two knobs **“Time Left”** and **“Time Right”**, respectively for setting the time for the left channel and the right channel, two knobs **“FeedB. Left”** and **“FeedB. Right”** respectively setting the feedback of channels left and right, and finally a **“Dry/Wet”** knob which sets the relationship between the original signal and the modified signal.

The **“Midi Sync”** switch lets you synchronize delay return time to the tempo of the host application.

Of all forms of sound synthesis, subtractive synthesis is one of the oldest and still certainly one of the most employed today. It is this method that was developed toward the end of the 60's on analog synthesizers like the Bob Moog's ones, ARP, Yamaha, Buchla, Oberheim, Sequential Circuits (Prophet series), Roland, Korg (MS and PS series) and many others. This concept of synthesis is still used on most current digital synthesizers, complementing sample reading or wave tables, which progressively replaced the analog oscillators of the first synthesizers in the 80's. The 1971 Bob Moog's monosynth, or even your own Mini V, is among the best illustrations of the enormous possibilities of subtractive synthesis.

6.1 THE THREE MAIN ELEMENTS

6.1.1 The oscillator, or VCO

The oscillator (**Voltage Controlled Oscillator**) is the starting module (with the noise module which is often classed among the oscillators) for the creation of a sound on an analog system.

It will generate the initial sound signal. We can think of the oscillator like a violin string that once stroked or plucked, vibrates to create its sound.

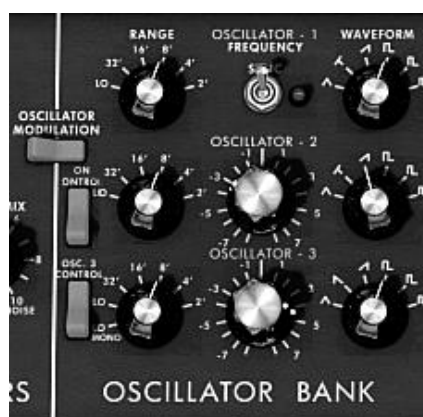

The oscillator settings

The main oscillator settings are:

- ▶ The **pitch**, determined by the oscillation frequency. You can set the frequency of the oscillator with 2 controllers: first, the "RANGE" selector which determines the fundamental frequency – it is expressed in feet: Low, 32, 16, 8, 4, 2; the highest number (32) brings the deepest tone, inversely, the smallest number (2) brings the highest tone. Secondly, the detune setting ("FREQUENCY") lets you tune the oscillator more precisely.

On the Mini V, the "RANGE" and "FREQUENCY" buttons are placed in the "OSCILLATOR BANK" panel.

- ▶ The **waveform**, which determines the harmonic richness of the audio signal. On the Mini V, 6 waveforms are available:
 - triangle
 - saw-triangle
 - sawtooth
 - square (duty cycle: 48%)
 - wide rectangular (duty cycle: 29%)
 - narrow rectangular (duty cycle: 17%)



The Mini V waveforms

6.1.1.1 Triangle

The **triangle** can be considered like a very filtered (and soft) square signal. It is very low in harmonics (odd only) and will be very useful for creating sub basses, flute sounds, etc.

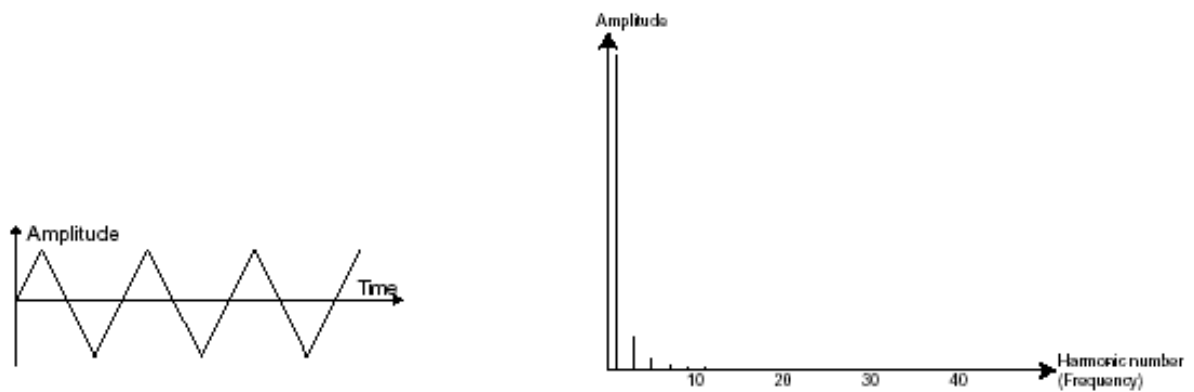

*Time and spectral representations of the **triangle** waveform*

6.1.1.2 Sawtooth

The **saw tooth** presents the richest audio signal of the 4 waveforms (it contains all of the harmonics at decreasing volume levels in high frequencies). Its sound is ideal for brass sounds, percussive bass sounds or rich accompaniments.

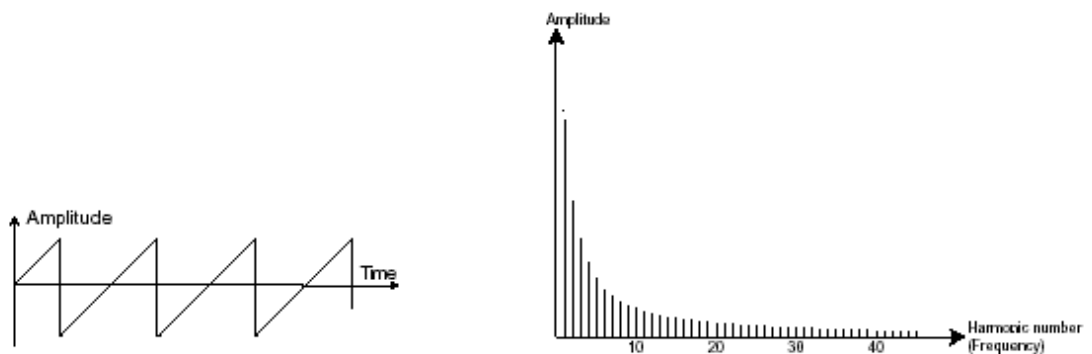

*Time and spectral representations of the **sawtooth** waveform*

6.1.1.3 Square

The **square** possesses a more “hollow” sound than the saw tooth (it only contains odd harmonics) but none the less, its rich sound (notably in low frequencies) can be used for sub-bass sounds that will come out well in the mix (the square oscillator is often set an octave below that of the saw tooth), wood sounds (clarinet, if the square signal is a little filtered), etc.

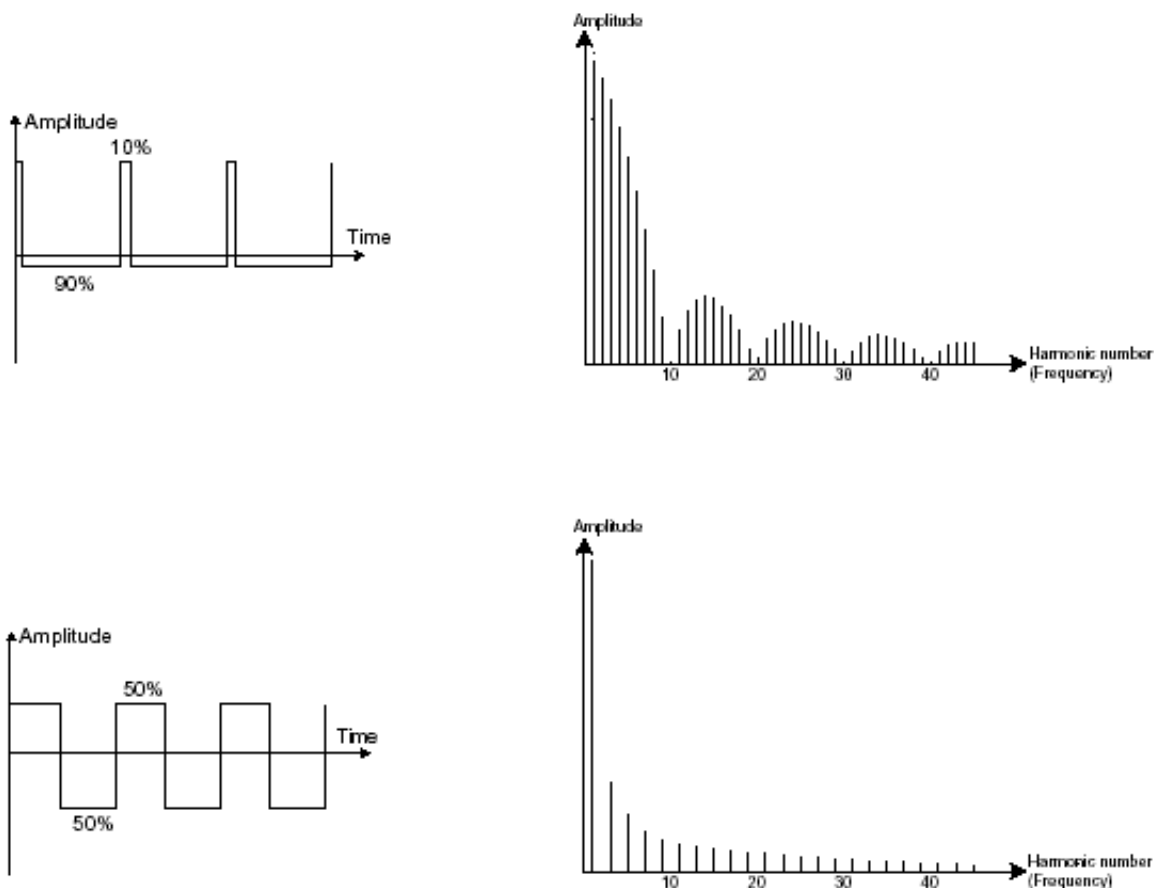

Time and spectral representations of the **pulse** (top) and **square** (bottom) waveforms

The original synthesizer proposed 3 types of square waveforms (square – 50%, wide rectangle – 25% and narrow rectangle – 10%). This choice allowed compensation for the missing PWM setting. The Mini V offers these 3 waveforms but includes also the pulse width modulation.

6.1.1.4 Pulse Width Modulation

The **PWM** (**P**ulse **W**idth **M**odulation) is a setting that allows you to modify the duty cycle of the square waveform. This can be done through a modulation only (with an envelope or a LFO). This pulse width variation translates to a spectrum modification, resembling a waveform change.

Unlike classic analog synthesizers, the Mini V lets you change the impulse width not only for the square waveform but also for the triangle. This brings a large number of additional sound possibilities to complement the base signal.

6.1.1.5 Synchronization

The **synchronization** of an oscillator with another creates more complex waveforms. If for example, you synchronize oscillator2 with oscillator1, oscillator2 will restart a new period every time the first oscillator completes a period, even if oscillator2 has not completed a complete period (this signifies that it is not tuned to the same tonality!) The more you tune oscillator2 upwards, the more you will encounter composite waveforms.

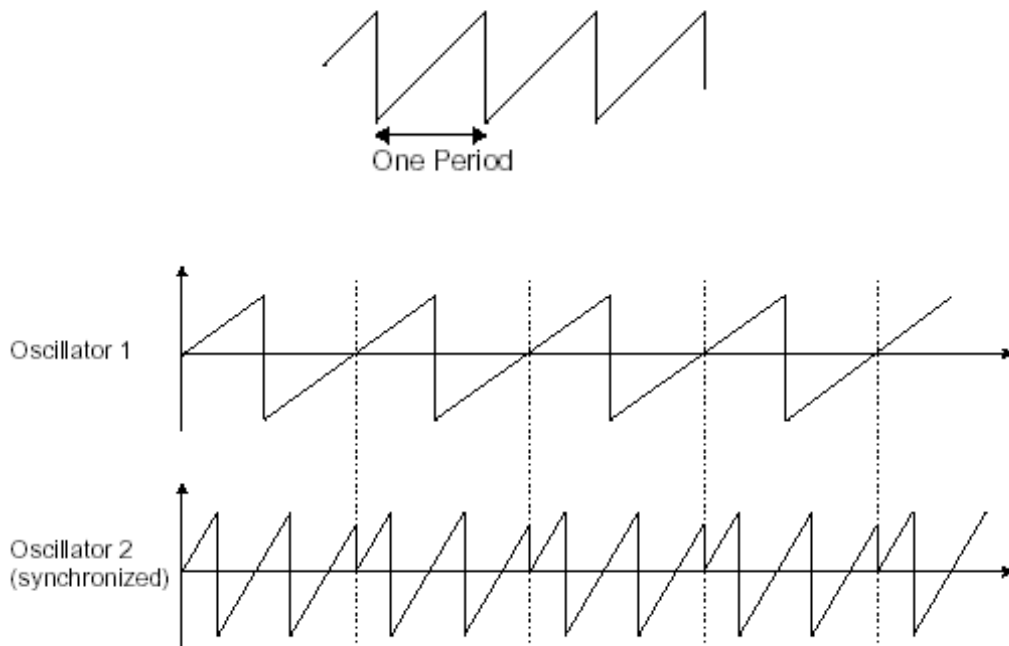

In the above image, oscillator2 is synchronized with the first and tuned to double the tonality. The resulting waveform is unique in that it cannot be created by standard synthesis techniques such as layering or filtering.

6.1.1.6 Frequency modulation

A **frequency modulation (FM)** can be created between 2 oscillators by connecting the audio output from a first sinusoidal oscillator to the modulation input of a second oscillator. On the Mini V, if you turn the modulation rate ring, you will obtain a sound richer in harmonics. If you introduce a square or sawtooth signal, the result can be quickly distorted... but interesting for inharmonic sonorities like bell sounds or special effects for example.

FM

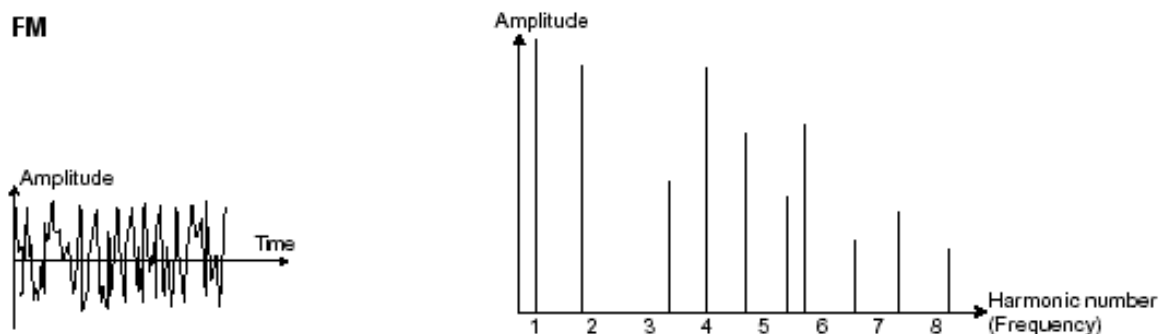

Time and spectral representations of a frequency modulation

6.1.2 The noise module

The noise signal spectrum has all frequencies at an equal volume level, often referred to as "white noise". For this reason, the noise module is used to create different noises like the imitation of wind or special effects. White noise is the richest of noises. Pink noise is also regularly present on synthesizers. It is less rich in the high frequencies than white noise.

Also note that the audio output of noise can also be used as a modulation signal (especially when strongly filtered) to create random cyclic variations.

On pre-cabled synthesizers, the noise module is either integrated into the oscillator (its audio output being placed to compliment the waveform outputs), or within the mixer directing the signals towards the filter.

On the Mini V, you will find the noise generator amongst the settings in the mixer panel. A switch allows you to choose between the white and the pink noise.



The noise generator set on the mixer

6.1.3 The Mixer

The audio signal generated from an oscillator is generally directed to a module filter (VCF). It will be first useful to individually set the volume of each oscillator, external audio source or noise, thanks to the "Mixer".

The external audio signal could be, for instance, a recorded vocal track or a drums loop.

6.1.4 The filter or VCF

The audio signal generated by an oscillator (the waveform) is next generally directed to a filter module (**Voltage Controlled Filter**). It is this module that we use to control the sound by filtering (by subtraction, which explains the name given to this type of synthesis) the harmonics situated around a cut-off frequency. It can be considered to be a sophisticated equalizer that reduces, depending on the case, the high or low frequencies of a sound.

6.1.4.1 The cut-off frequency

The removal of undesirable frequencies at the cut-off frequency is not done suddenly but progressively, depending on the filtering slope. This filtering slope is expressed in decibels per octave (or dB/Oct). The filters used in classic analog synthesizers have 24 dB/Oct or 12 dB/Oct slopes.

The Mini V offers 1 type of slope: 24 dB/Oct slope.

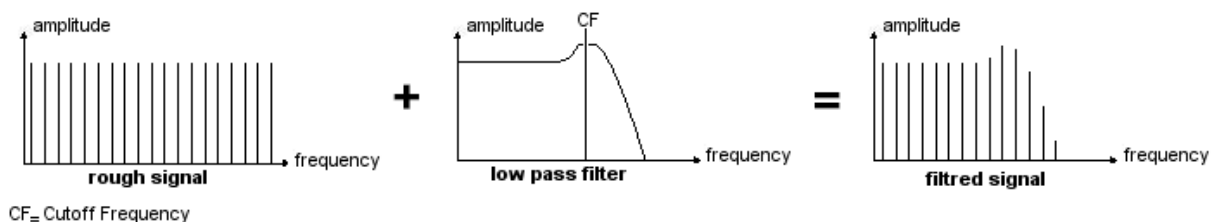

*Spectral representation of a **rough** then **24dB LP filtered** signal*

On the Mini V, you have access to one type of filtering.

The low-pass filter (LPF) progressively removes high frequencies above the assigned frequency limit (the cut-off frequency) and allows the sound below the cut-off to pass through unchanged. Depending on the setting we will hear the sound becoming more or less "brilliant", more or less "dampened".

This is the type of filtering that you will find more than often on synthesizers that use subtractive synthesis. It can be found on most of the recent analog and digital synthesizers.

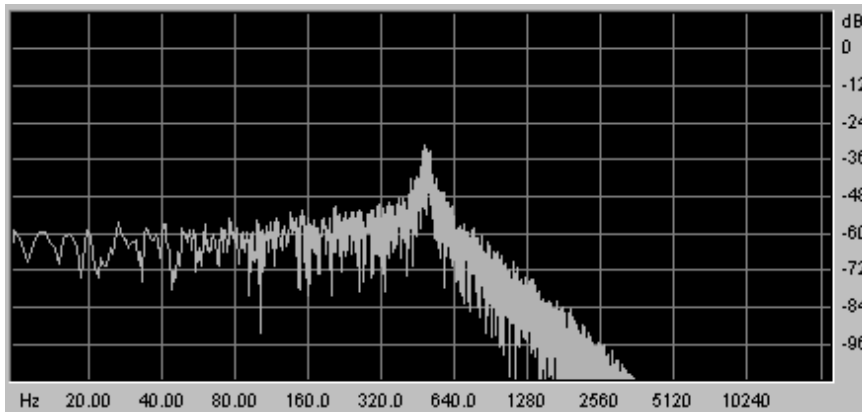

Spectrum of a noise signal processed with a low-pass filter

6.1.4.2 The resonance

A second setting to compliment the cut-off frequency: the resonance. You will also find it called "Emphasis" or "Q" – for Quality of filtering.

The resonance amplifies frequencies close to the cut-off frequency. The other frequencies remaining are either unchanged (below the cut-off frequency) or reduced (above the cut-off frequency).

On the Mini V, you can increase the rate of resonance through the "emphasis" knob.

When you increase the resonance, the filter becomes more selective, the cut-off frequency is amplified, and the sound begins to "whistle".

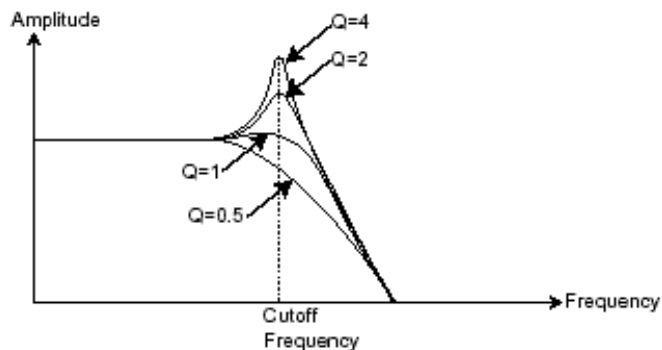

Q = resonance

With a high resonance level, the filter will begin to produce a sound close to a sine waveform. At this stage, the use of a key follow is very important as you can create a melody by tuning the cut-off frequency of the filter with the frequency of the oscillators.



The filter settings of the Mini V

6.1.5 The amplifier or VCA

The amplifier (**Voltage Controlled Amplifier**) receives the audio signal coming from the filter to be adjusted before the volume is sent to the speakers.



The Mini V VCA

In conclusion, here is a diagram that should help you to understand the composition of a basic sound:

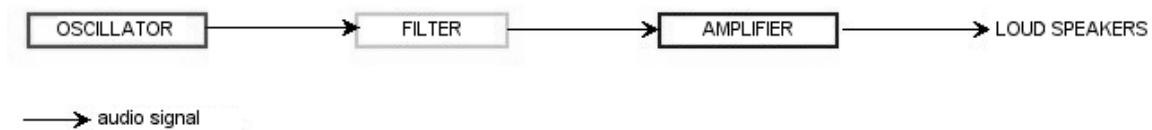

Basic audio path in analog synthesis

6.2 OTHER MODULES

6.2.1 The keyboard

If we stop here, the sound that you will obtain will be uniform, without life and without an end!! The oscillator delivers a sound signal (the audio output of a waveform) of a fixed pitch in a continuous manner. In the diagram above, the only way to stop this quickly unpleasant sound is to lower the filter cut-off frequency so that it becomes more and more damp until it finally disappears; or simpler yet, lower the volume of the amplifier!

- ▶ To start and stop the sound, and this at the tone that we require, we use a keyboard that is connected both to the VCA through a gate and to the frequency of the oscillators. This will “play” the sound as soon as a key is pressed, and mute it when released. Of course, this connection is made through MIDI (it replaces the “gate” type of connections on analog synthesizers, which trigger the note when a key is pressed and stop it when released).
- ▶ The key position provides a control voltage that tells the oscillator what pitch level to play when the gate opens.

If you don't have a MIDI keyboard, you can also play on the virtual keyboard of the Mini V to audition sounds while editing voices on your computer.

6.2.2 The envelope generator

The envelope generator, connected to the amplifier, is used to “sculpt” the volume of the sound when we press a key on the keyboard and ends after the note is released.

The most common modules developed use 4 settings that we can vary:

The **Attack** is the sound that the sound will take to reach its maximum volume once we have pressed a key on the keyboard.

The **Decay** (fall) is the time that the sound will take to diminish after the attack portion is complete.

The **Sustain** (hold) is the maximum volume level that the sound will reach after the decay is complete.

The **Release** is the time that the sound will take to fade once the key has been released.

*The two envelopes of the Mini V (Contour) contain only 3 parameters: **Attack**, **Decay** and **Sustain**. You can get the **Release** thanks to the "**Decay**" button located on top of the modulation wheels. The release time is thus identical to the decay time of the envelope.*



The Mini V ADS(R) envelope

6.2.3 The low frequency oscillator

The LFO (*Low Frequency Oscillator - or LFO on the Mini V*) possesses more or less the same characteristics of the classic oscillator but it only produces frequencies lower than 20 Hz. In other words, you won't hear the pitch of its sound.

It will create a cyclic modulation on the setting to which it is connected.

For example:

- ▶ If the sine waveform of an LFO modulates the volume of an amplifier, the sound will increase in volume then disappear in a varying manner following the speed (the frequency) of this LFO. This will produce a **tremolo** effect.
- ▶ A sine waveform on an LFO modulating the frequency of an oscillator would produce a **vibrato** effect.
- ▶ With an LFO sinusoid wave modulating the cut-off frequency of a slightly resonant low-pass filter, you will obtain a "**wah wah**" effect.

The original model does not contain any dedicated LFO. You can use the third oscillator in low frequency ("Lo" position of the "Range" selector) to modulate the filter and oscillators' frequency. The signal of the third oscillator can be mixed with the noise signal to create some random modulations.



The LFO module of the Mini V

Now to finish, here is the diagram of a complete synthesis voice on the Mini V containing:

- 3 oscillators (VCO)
- 1 noise module
- 1 mixer (mixing of the 3 VCO and the noise generator)
- 1 low-pass filter (VCF)
- 1 amplifier (VCA)
- 2 envelopes (one for the filter and the other for the VCA)
- 1 LFO

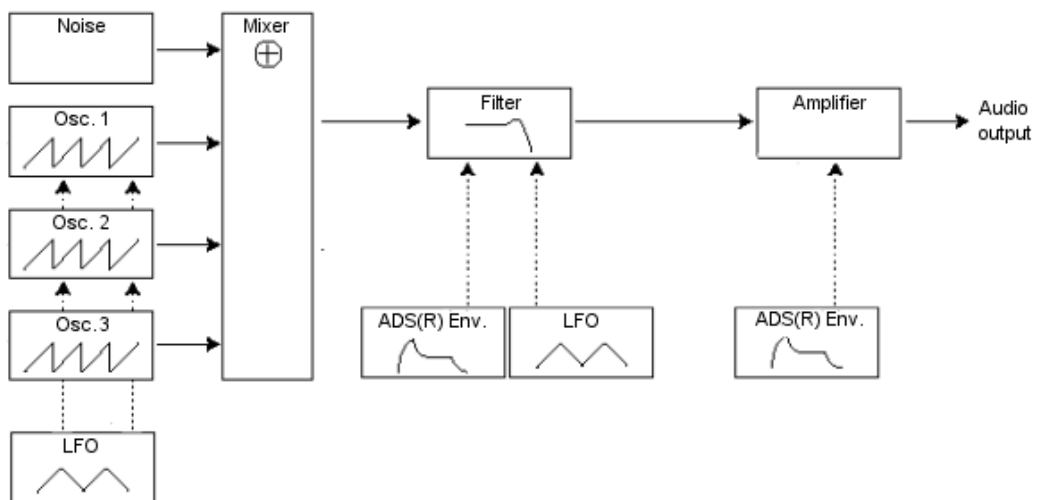

A complete Mini V synthesis voice

Here is a series of examples designed to guide you through the creation of a sound and a sequence. They are classed in order of difficulty going from the easiest to the most difficult and are organized into 3 parts:

- The first part will help you to grasp subtractive sound synthesis. You will start with the most basic patch (make a VCO oscillator “sound” in an output VCA amp), to finish by touching on the programming of a more rich sound (several oscillators, the filter, the frequency modulation of the filter and oscillators).
- The second will help you to use the modulation matrix
- Finally, the third part will teach you to use the arpeggiator and the effects.

7.1 SUBTRACTIVE SYNTHESIS

7.1.1 A simple bass sound

To begin we will see how to program a bass sound. As we saw in chapter 3 (Quick Start), the Mini V uses 3 oscillators. We will only use the first for this example. It will be composed of:

- An oscillator
- A low pass filter (Filter)
- An output VCA (Output)
- The envelope corresponding to the filter
- The envelope corresponding to the output amplifier (Loudness Contour)

You will thus obtain a base patch for subtractive synthesis.

- ▶ Choose the preset “Temp_Blank” in the “Templates” bank, sub-bank “Temp_Synth”. This preset does not produce sound yet! Don’t worry, this is normal.

The following image shows the different knob positions:

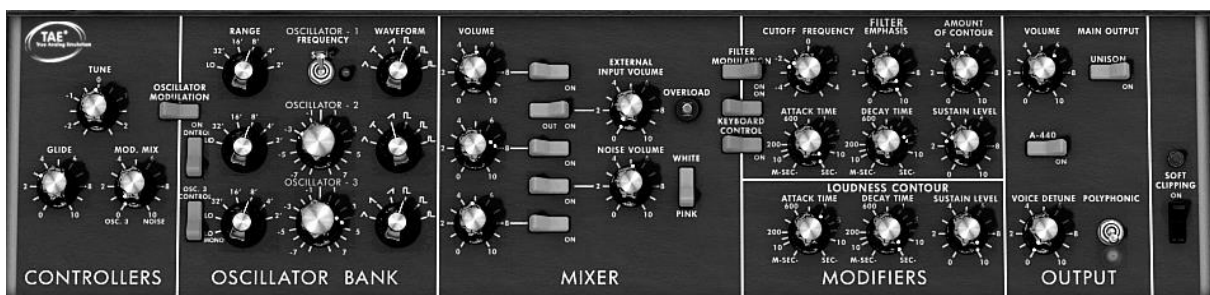

- ▶ So as to hear the sound, click on the first of the 5 blue “Mixer” switches. This activates the signal coming from the first oscillator.



You will notice that the sound is particularly linear and without life. The sawtooth signal from the first oscillator goes through a filter where the cut-off frequency is set to the maximum. This minimalist configuration will let you easily perform some simple experiments with this basic sound.

- ▶ Start by changing the waveform of this oscillator to appreciate some of the tones it can produce.

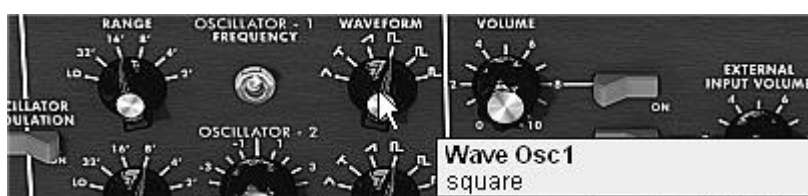

Change the waveform of oscillator1

- ▶ Progressively lower the cut-off frequency of the low pass filter. The sound becomes more and more "damp".



Lower the cut-off frequency of the low pass filter

- ▶ Change the range of the oscillator with the "range" knob (as a default it is set to 8'). In this case, lower it to 16'.



Change the range of oscillator1

- ▶ Increase the decay time for the filter envelope ("Decay") to a value somewhere around 400ms so that the cut-off frequency progressively decays when you press a key.

You will thus obtain a simple yet efficient bass sound.



Increase the decay time for the filter envelope

- ▶ You can now save your sound by clicking on the “Save As” situated on the left of the toolbar. It will be useful as a base template for programming lots of other sounds.

7.1.2 A 3 oscillators lead sound

Keeping the current sound and we will now go a little further and create a rich lead sound.

It will be composed of:

- 3 oscillators
 - A low-pass filter (Filter)
 - An output VCA (Output)
 - The envelope corresponding to the filter
 - The envelope corresponding to the output amplifier (Loudness Contour)
- ▶ Start by again increasing the “Decay” time for the filter envelope so as to prolong the fall of the cut-off frequency. By using a value somewhere around 2000ms, the sound will seem “brighter”.
 - ▶ So as to hear the sound from the 2 other oscillators, click on the 3rd and 5th blue “Mixer” switches.
 - ▶ Change the range of oscillator 3 with the “range” switch. Set it to 4’ for example.

The sound takes another form. Don’t hesitate in changing the waveforms of the three oscillators to hear the different tones that result. You can also change the volume of these oscillators to create a different balance.

- ▶ Now change the coarse tone of oscillator 3 to give it another tone. For this, click on the central knob with the right mouse button and turn it gently to the right until you reach the value “7 semi tone”.



Change the coarse tone of oscillator3

Lightly detune oscillator 2 from the two others by turning this same knob with the left mouse button. The sound will begin to “move” slightly and sound “warmer”.

If you want a sound that is even “fatter”, click on the “Unison” switch which brings all of the polyphonic voices to the same note. Lightly detune each of the polyphonic voices with the “Voice detune” knob (“Output” section).

Here is how, in a few seconds, to transform a simple base sound into the kind of powerful lead preset that made the 1971 Bob Moog’s monosynth so famous.

- ▶ Save the preset with the “Save As” button in the toolbar.

7.1.3 A polyphonic accompaniment

Unlike the original synthesizer which offered just a monophonic playing (one note at a time), the Mini V allows you to play chords with the "Polyphonic" playing mode located in the "Output" module on the right of the synthesizer.

Let's see how to create a powerful evolving accompaniment.



The "Polyphonic" mode

This preset will be composed of:

- 2 oscillators
 - A low-pass filter (Filter)
 - An output VCA (Output)
 - The envelope corresponding to the filter
 - The envelope corresponding to the output amplifier (Loudness Contour)
 - Oscillator3 in low frequency modulating the filter cut-off frequency
- Take the preset "Temp_2_Osc" in the "Templates" bank. This sound is already composed of 2 active oscillators which you will use as a base sound.
- Place the "Range" of oscillator2 to 8' so that the 2 oscillators play in unison.
- Slightly detune this same oscillator to obtain a richer sound: turn the central knob to the right or left with a left click; take for example the value "fine tune" 1.0020.
- Lower the filter cut-off frequency to make the sound less "bright". Take for example a value of -2.00 - 256.96 Hz.
- Increase the amplitude envelope attack time ("Loudness Contour") to around 4000ms. Set the "Decay" time to around 700ms.

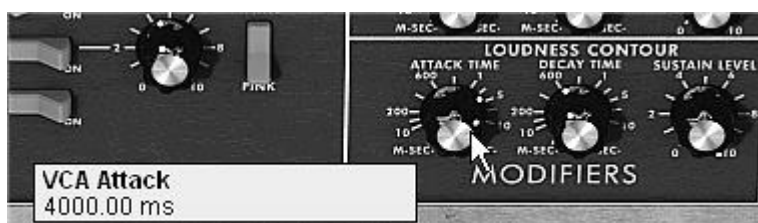

Increase the amplitude envelope attack time

- Do the same with the filter envelope.
- Place the "Range" knob of oscillator3 to Low mono (the last position on the left). It will oscillate in low frequencies (like a LFO)
- Lower the tuning to -48 (-4 octaves) by turning the central knob to the left with a right click on the mouse. This oscillator will not produce audible sound (if only light

“clicks” marking the oscillation cycle), it will be used to modulate the filter cut-off frequency.

- ▶ Click on the “Filter Modulation” switch to activate the filter cut-off frequency modulation by oscillator3.

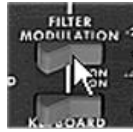

Click on the Filter Modulation switch

- ▶ Raise the modulation wheel to maximum to set the modulation frequency.

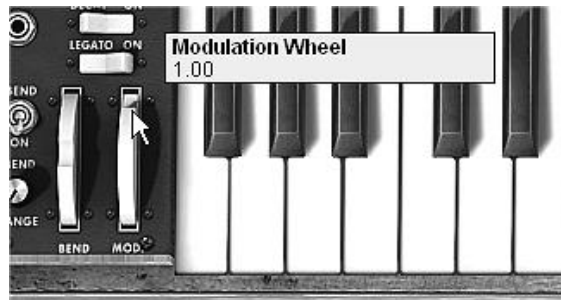

Raise the value of the modulation wheel

You will obtain a rich accompaniment sound.

7.2 THE MODULATION MATRIX

We will discover a few of the many additions to the Mini V: the modulation matrix, the LFO and the velocity.

For this, let's again use the preset “Tp_EG_Ampl_Long” in the “Templates” bank, sub-bank “Temp_Synth”. This preset offers an ideal starting point for an accompaniment sound (the amplitude envelope is already calibrated for this type of use).

It will be composed of:

- 2 oscillators
- 1 lightly resonant low-pass filter
- 1 output VCA
- The filter and VCA envelopes are active
- Oscillator 3 modulates the 2 other oscillators for a vibrato effect brought by the action of the modulation wheel.

The modulation matrix will be active for:

- A modulation of the cut-off frequency by the velocity
- A modulation of the width of the oscillator2 square by the LFO

To begin, lower the filter cut-off frequency to around “-4.46: 44.00 Hz”. This will make the different modulations easier to hear.



Lower the filter cut-off frequency

- ▶ On the matrix, start by choosing the first source of modulation by clicking on the display on the left of the first line: "LFO" (for **L**ow **F**requency **O**scillator)

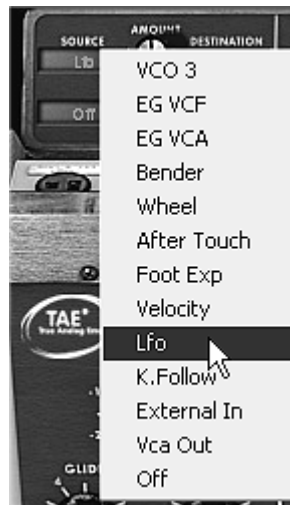

Choice of source

- ▶ Do the same thing for the first destination by clicking on the display situated on the right of the first line: choose "VCO2 PW" (square width of oscillator2).



Choice of destination

Increase the rate of modulation by turning the "Amount" knob between the two displays. Place it at a value of 0.0480. The square width of oscillator2 lightly varies in a manner so as to create a detuning between the 2 oscillators.



Turn the "Amount" knob

- ▶ For the 2nd source of modulation, choose the "Velocity" to modulate the filter "Cutoff".
- ▶ Turn the "Amount" knob to a value of **0.31**.



The velocity to modulate the "Cutoff"

- ▶ Place the "Range" knob of oscillator3 to Low mono (the last position on the left). It will oscillate in low frequencies (like a LFO)
- ▶ Lower the tuning to -48 (-4 octaves) by turning the central knob to the left with a right click on the mouse. This oscillator will not produce audible sound (if only light

“clicks” marking the oscillation cycle), it will be used to modulate the filter cut-off frequency.

- ▶ Now, click on the Filter Modulation to activate the filter cut-off frequency modulation by oscillator3.
- ▶ Finally, increase the value of the modulation wheel to set the rate of modulation on the frequency of modulation.
- ▶ By varying the force of playing on the keys of your MIDI keyboard (velocity), the filter cut-off frequency is varied with each note.

The 3 examples that we have just seen will give you the basics necessary in order to delve a little deeper. Try other settings. The possibilities for synthesis are numerous.

7.2.1 Using the arpeggiator

Now let's see how to program and play the arpeggiator by using the lead sound from the previous section 8.1.2.

- ▶ Click on the arpeggiator “Play” button.



Click on the “Play” button

- ▶ Play a chord between C4 and C6, the notes will be played one after the other in the order in which you have placed them. (it is possible to changing the playing order by clicking on the linear “mode” knob)
- ▶ If you want, it is possible to keep the chord continuous by clicking on the “Hold” switch. Two types of playing are available in this mode: “Hold” (central position) lets you add notes to an existing chord and “Memory” (low position) allows the change of chord type freely.



The “Memory” position

- ▶ To remove one or several notes or add notes without keeping them in the arpeggio, click again on the “Hold” switch to set it to “Off” position (to the top) and play the note to be removed.
- ▶ To remove one or several notes, click again on the “Hold” and play the note to be removed.

It is now possible to simultaneously play (or record) a bass part on the first octave of your keyboard, accompaniments on the 2 following octaves all while having an arpeggio which develops on the latter two.

7.3 THE EFFECTS OF THE MINI V

The Mini V offers two additional effects letting you add another color and more space to your sound.



The Chorus and Delay effects

7.3.1 The stereo chorus

- ▶ For this example, take the sound of the accompaniments from the previous paragraph 8.1.3. Add chorus by clicking on the "Chorus" button on the right of the toolbar.



Add chorus

Chorus is used to create an effect of doubling the sound, which gives more width and "thickness". If you accentuate the intensity of the effect you will obtain a very detuned sound.

The speed of modulation can be set with the "Rate" knob, the amplitude with the "Depth" knob and the mixing between the initial sound and the effect with the "Dry/Wet" knob.

The 3 "Type" buttons choose between the 3 types of chorus: simple, medium, complex.

- ▶ To clearly hear the different depths of modulation, simply increase the value of the "Depth" knob. The higher the value, the more detuned the sound becomes! For a classic chorus, use minimal values (around 0.16)



The "Depth" parameter

- ▶ Set the modulation speed by turning the "Rate" knob. The faster the speed, the faster the detuning. Here again, use values situated around 0.50 Hz if you wish to have a slight detuning.



The "Chorus Rate" knob

- ▶ Place the "Dry/Wet" knob to the center (Dry:50.00%, Wet: 50.00%) to obtain a balance between the gain applied to the signal without effect ("Dry") and the setting of the gain applied to the treated signal ("Wet").



The "Dry/Wet" knob

7.3.2 The stereo delay

This module allows you to repeat the incoming signal in an independent manner for the left and right tracks so as to create stereo echo.

The speed of repetition is set for the left and the right with the "Time left & right" knobs, the number of repetitions heard can be set with the "Feedback Left & Right" knobs and the mixing between the initial sound and the treated sound with the "Dry/Wet" knob.

- ▶ To set the time between the repetitions of the left track turn the "Time Left" knob.
- ▶ Do the same thing with the "Time Right" knob for the right track.



The "Time Left" knob

To obtain a stereo effect, it is important that the two time settings (Time Left & Right) have different values.

- ▶ A 2 position "MIDI Sync" switch synchronizes the repetition time with the tempo of the host application. This will help to quickly find the appropriate timing for each side. Try for example the values "Tempo" (synchronized to a crotchet) for the left and "Tempo 1.5" (synchronized to a dotted crotchet) for the right side.



Synchronization of delay to MIDI tempo

- ▶ Now set the number of repetitions for both sides by turning the "Feedback Left & Right" knobs.



The "Feedback Left" setting

- ▶ To finish, as for the chorus effect, place the "Dry/Wet" knob to the center (Dry:50.00%, Wet: 50.00%). You will obtain a balance between the gain setting applied to the signal without effect ("Dry") and the gain setting applied to the treated signal ("Wet").

These different examples, as you will have noticed, presented different levels of difficulty. We hope that they will have allowed you to see a few of the possibilities offered by the Mini V. But don't hesitate to try your own settings, this is the best way to progress and have more originality.

8.1 STANDALONE

Mini V can be used as an instrument independently from a sequencer software (Standalone mode).

This allows you launch the application as a single instrument, and to play it using an external MIDI keyboard.

8.1.1 Launch the application

To launch the Mini V application,

- on Windows, go to the menu Start > Programs > Arturia > Mini V, and choose "Mini V".
- on Macintosh, open the finder > Applications > Arturia and double-click on the Mini V application icon.

8.1.2 Configuration of the instrument

Click on the "Settings" button on the Mini V toolbar. It will show the following "Audio MIDI Settings" dialog box.

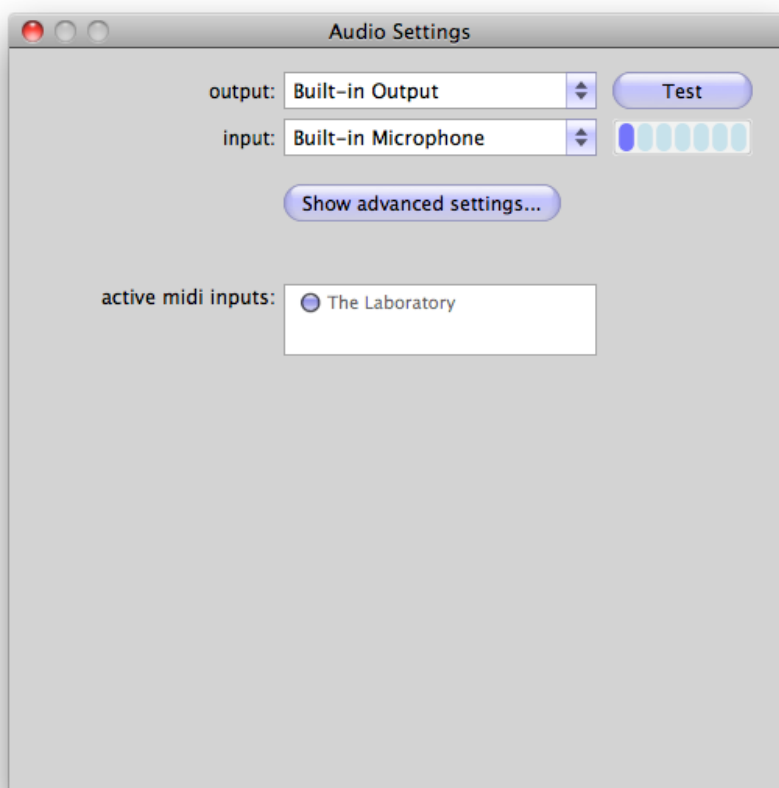

In this option menu you can:

- Set the audio output port
- Choose the audio interface
- Choose memory buffer size (smaller size will increase the load on the CPU but will reduce latency, and reciprocally)
- Choose sample rate between 44100 Hz and 96000 Hz
- Choose one or several active MIDI input port(s)

8.2 VST 2

VST (Virtual Studio Technology) is a plug-in standard created by Steinberg. It allows you to integrate software audio synthesizers and effect plug-ins with audio DAWs and host software. VST is supported by a large number of audio applications like Cubase, Nuendo, Wavelab, FL Studio, Audacity, Samplitude, Sonar, Audition, Live, etc.

The VST interface was updated to version 2 in 1999. One of the additions was the ability for plug-ins to receive MIDI data. This allowed for the introduction of VSTi (Virtual Studio Technology Instrument) format plug-ins.

8.3 VST 3

VST3 is a new update of VST audio plugins protocol. It was updated in 2008. This has improved performance over previous versions of VST and has many new features as well. Cubase 6 and Nuendo 5 are using this new protocol.

With VST3 on Windows, users do not have to choose a folder path to install the plug-in. The installer will put VST3 files automatically into the appropriate directory on your hard drive.

8.4 RTAS

RTAS, short for Real-Time AudioSuite is an audio plug-in developed by Digidesign (AVID technology) for their Pro Tools systems.

8.5 AU

AU for Audio Units is a plug-in protocol developed by Apple Computer. It used by Apple applications such as GarageBand, Soundtrack Pro, Logic Express, Logic Audio, Final Cut Pro, Mainstage, Ardour, Ableton Live, REAPER and Digital Performer.

8.6 64 BIT COMPATIBILITY

Mini V is optimized for both 32-bit and 64-bit modes. If you have a 64-bit operating system and a 64-bit digital audio workstation, you should use 64-bit version of the plug-in (for Windows).

Usually on 32-bit Windows, all 32-bit programs are installed in C:\Program Files. However on 64-bit Windows, you can find the 64-bit programs in C:\Program Files\ and the 32-bit programs in C:\Program Files (x86)\.

Mac users don't have to bother with this, because the same plug-in file contains both the 32-bit and the 64-bit versions, and the host automatically chooses the better one.

8.7 USE IN CUBASE/NUENDO (VST)

8.7.1 Instrument use in VST mode

The opening of a Mini V VST plug-in is the same as opening all other VST plug-ins. Please consult the instruction manual of your host sequencer for more specific information. Under Cubase/Nuendo, create a new "Instrument" track, and choose Mini V in the rack.

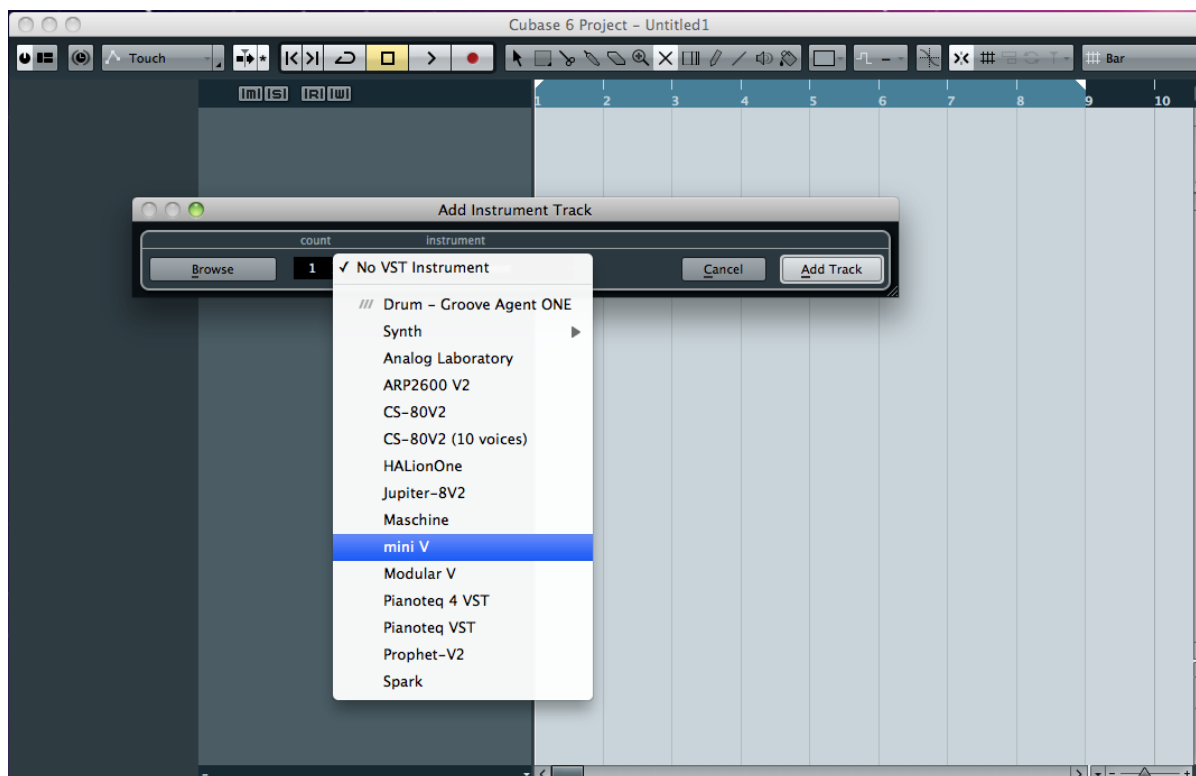
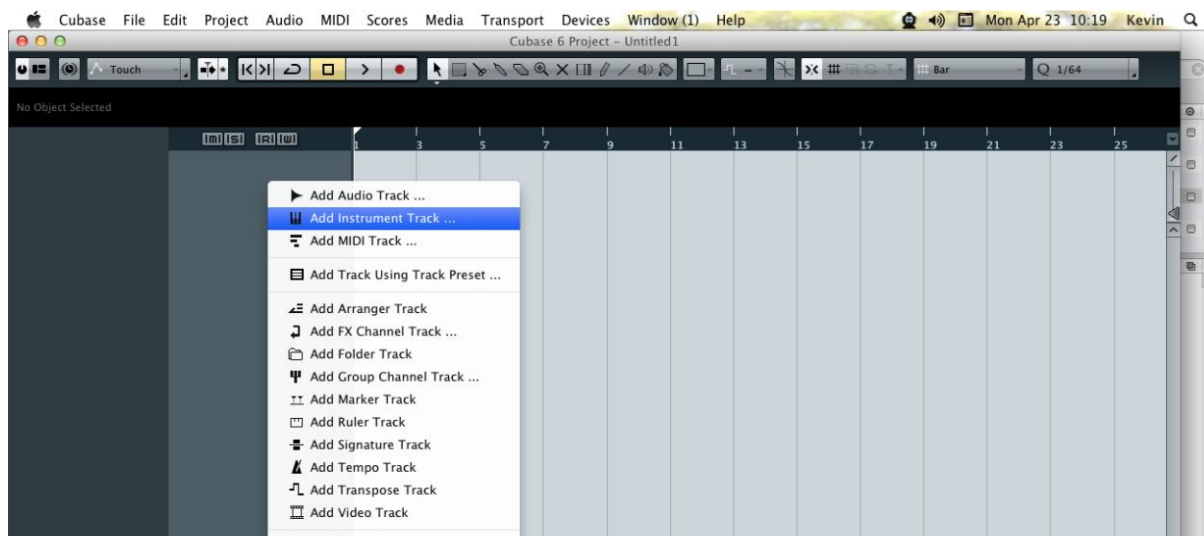

8.7.2 Rescan the plug-in directory in Cubase

If the Mini V does not appear in the list of VST plug-ins, you can perform a “rescan” of the plug-in directory.

8.7.3 Saving of presets

When the session/project is saved, Mini V is saved in its last mode of operation, with all modifications intact. For instance, if you were working on a “P1” preset in which you had modified parameters (without saving them as a separate preset within the plug-in itself), the next time you open the project, Mini V will load the “P1” preset plus the modifications you made previously.

The drop-down menu in which the VST sequencer allows you to save a new preset is of course usable with Mini V. However, it is highly advised to use the Mini V internal menu: the presets saved in this way are usable in any other mode (standalone or with other sequencers), they can be exported and exchanged more easily, and they will remain compatible with the Mini V future versions.

8.8 USING IN PRO TOOLS (RTAS)

8.8.1 Opening of the plug-in

Access to the Mini V plug-in is like all other plug-ins in Pro Tools, via a new Instrument Track creation:

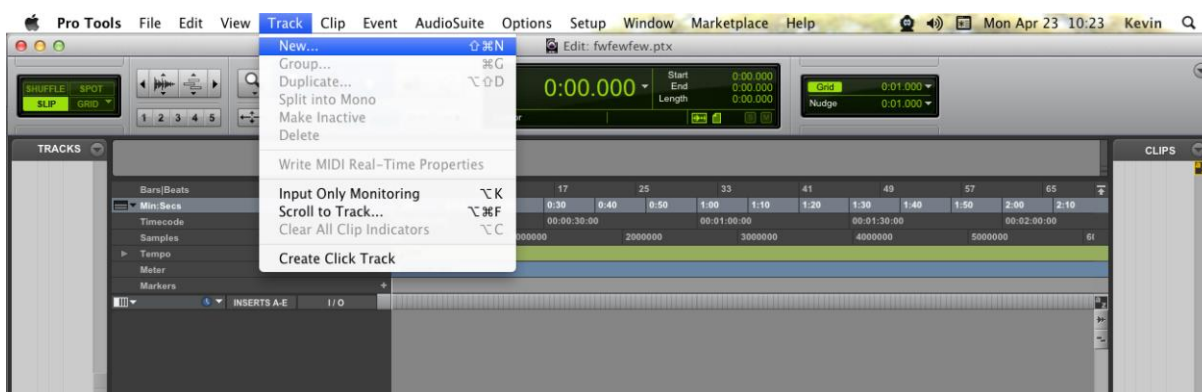



Mini V must be loaded on an instrument stereo track. We can now make Mini V sound by playing with the mouse on the virtual keyboard.

8.8.2 Saving the presets

When the session is saved, the status of Mini V is saved as it is, even if its programming does not correspond to the preset. For example, if you are working on a preset "P1" in which you have modified the parameters (without saving them in the plug-in itself), the next time you open the session, Mini V will load the "P1" preset plus the modifications you made to it. The "Librarian Menu" of Pro Tools can be used with Mini V like with all other plug-ins.

Nevertheless it is highly recommended to use the internal Mini V menu: with the presets saved like this, they are usable no matter which mode is chosen (standalone or other sequencer), and they can be exported, exchanged more easily, and will stay compatible with future versions of Mini V.

8.8.3 Automation under Pro Tools

The automation function with Mini V functions like with all RTAS/HTDM plug-ins (check the Pro Tools documentation for more details on plug-in automations).

8.9 USING IN LOGIC, MAC OS X (AU)

Make sure the plug-in has been tested OK in the Logic Audio Units Manager. To launch it, click on the menu "Preferences > Start Logic AU Manager".

Create a new Software Instrument track.



On the channel of the mixer corresponding to the selected track, click on the button "I/O" to list the available plug-ins, then select "AU Instruments > Arturia > Mini V > Stereo".

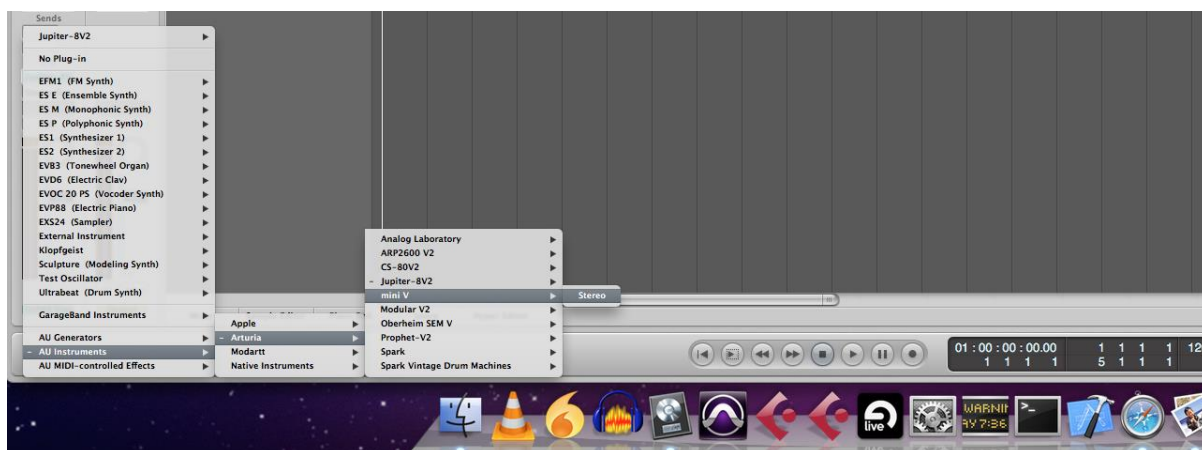

8.10 USING IN ABLETON LIVE (AU AND VST)

From the plug-ins tab, simply double click on the Mini V VST or AU icon, or drag-and-drop the plug-in into a MIDI track:

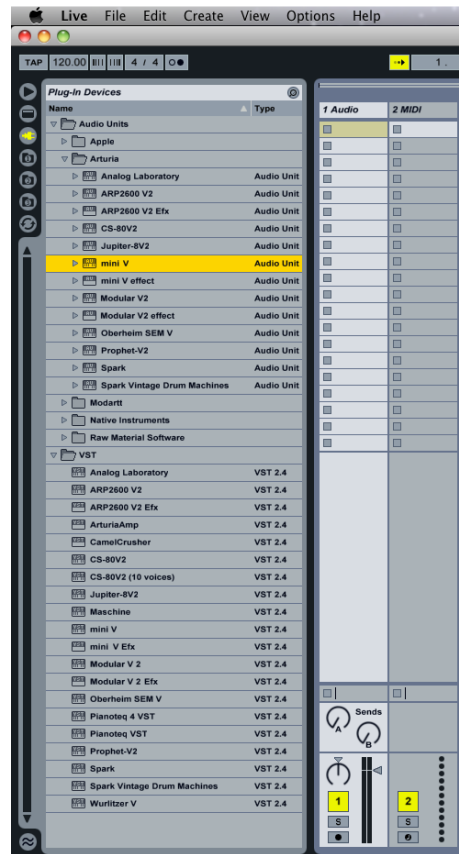
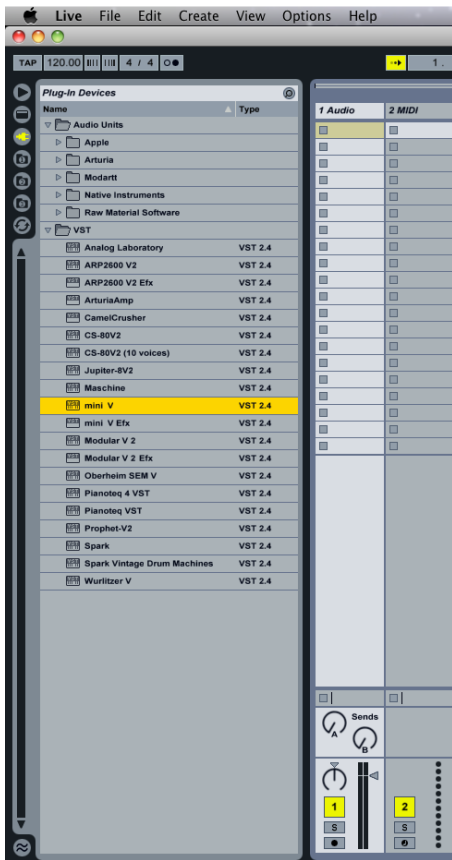

If necessary, you can perform a rescan of the plug-in directory in the Preferences, “File Folder” tab: press the “Scan” button, or press “Scan” while holding the [Alt] key for a full rescan.

1. General

1.1 In consideration of payment of the Licensee fee, which is a portion of the price you paid, Arturia, as Licensor, grants to you (hereinafter termed "Licensee") a nonexclusive right for the use of software including related media, documentation (for example program descriptions, manuals) and other documents and materials manufactured by Arturia SA ("Product(s)").

All intellectual property rights in the software belong to Arturia SA (hereinafter: "Arturia").

1.2 The following editions of the Product are available: "**Demo**", "**Standard**", "**EDU**" and "**NFR**". Whilst each edition equips the User with the same software, the editions vary as regards both the scope of functions activated in the Product, and the rights of use granted under this EULA.

1.3 By installing the software on your computer you agree to these terms and conditions. If you do not approve these terms and conditions, you must not install this software.

1.4 If you do not approve these terms and conditions, please return the complete Product (including all written matter, packaging and similar material) to the dealer from whom it was originally bought within 14 (fourteen) days after the day of purchase. For purchases from the Arturia Online Store, please contact Arturia on the internet website: www.arturia.com/support/askforhelp/purchase.

1.4 Arturia reserves all rights not expressly granted in the EULA.

2. Right of use

2.1 The Product is protected by copyright. The Licensee may not lease, loan or sub-license the software. The Licensee is not authorized to modify the software.

2.2 Owning any product provided to the Licensee as "**Standard**" version grants the Licensee a non-exclusive right to use the Product in perpetuity including commercial purposes. The Licensee can activate the Product on up to five computers, as long as only one installation is used at any given time. The Licensee must register the Product to Arturia to get access to client support, and to activate his Product. (An internet connection is required to register and activate the Product, either on the computer on which the Product is installed, either on another device able to exchange files with the computer on which the Product is installed). Owning a license of the Products entitles the Licensee to get access to the future updates of this Product.

2.3 Any Products provided to you as "**NFR**" (Not For Resale) version grants the Licensee a non-exclusive right to use the Product for a limited period of time. The Product shall only be used for demonstration, testing and evaluation purposes. NFR Products must not be used for commercial purposes, and must not be resold or transferred. The Licensee can activate the Product on up to five computers, as long as only one installation is used at any given time. The Licensee must register the Product to Arturia to get access to client support, and to activate his Product. (An

internet connection is required to register and activate the Product, either on the computer on which the Product is installed, either on another device able to exchange files with the computer on which the Product is installed). NFR Products are exempt from update, upgrade or crossgrade offers, and cannot be purchased with or exchanged for vouchers or coupons. Furthermore, as an owner of a NFR Product, you are not entitled to any vouchers that ship with the standard version of the Product.

2.4 Any Products labelled or otherwise provided to you as an **“Educational”** version grants the Licensee a non-exclusive right to use the Product in perpetuity. The Product shall only be used by students or those working in educational institutions. This definition includes students, faculty, staff and administration attending and / or working at an educational institutional facility: private / public schools, colleges, universities and similar. These Products must not be used for commercial purposes, and must not be resold or transferred. The Licensee can activate the Product on up to five computers, as long as only one installation is used at any given time. The Licensee must register the Product to Arturia to get access to client support, and to activate his Product. (An internet connection is required to register and activate the Product, either on the computer on which the Product is installed, either on another device able to exchange files with the computer on which the Product is installed). These Products are exempt from upgrade or crossgrade offers, and cannot be purchased with or exchanged for vouchers or coupons. Furthermore, as an owner of an educational Product, you are not entitled to any vouchers that ship with the standard version of the Product.

2.5 Any Products labelled or otherwise provided to you as a **“Demo”** version grants the Licensee a right to use the Product only for demonstration and evaluation purposes. These Products must not be used for commercial purposes, and must not be resold or transferred. These Products are exempt from upgrade or crossgrade offers, and cannot be exchanged for vouchers or coupons.

3. No Unbundling

Bundles (product bundles are an association of software and hardware or software-only products) can only be resold / transferred as a whole. The individual components of a bundle must not be resold / transferred separately.

4. Resell

4.1 Renting or lending the licensed Software to a third party is expressly forbidden. Apart from that and if not provided otherwise within this EULA.

4.2 Except if otherwise stated within this EULA, Licensee may resell the software to a third party or transfer the software permanently free of charge, provided the third party agrees in writing with this EULA and Licensee ceases all use of the software, completely removes all installed copies of the software from his computers and – if the software was not purchased via download – deletes or transfers the original media delivered with the software to the third party. In addition, Licensee is required to de-register the purchased software with Arturia (more information available on www.arturia.com).

5. In case a sound library is part of the purchased Product the following shall apply in addition to the EULA

The provided samples, instruments and presets can be used for commercial or non-commercial music and audio Productions without the prior permission from Arturia

under the terms of this Agreement. The usage of this Product (in particular samples, instruments and presets) for the creation of a sound library or as a sound library for any kind of synthesizer, virtual instrument, sample library, sample-based Product or other musical instrument is strictly prohibited. Individual samples, sound sets or audio loops may not be distributed (commercially or otherwise) standalone. Furthermore these samples, sound sets or audio may not be repackaged in whole or in part as audio samples, sound libraries or sound effects.

6. Data Protection

Arturia attaches great importance to compliance with legislation on data protection. The User data collected are used exclusively for performing its contractual obligations. No data is passed on to third parties. Further information can be obtained from our Privacy Policy at www.arturia.com/privacy.

7. Limited Warranty

Arturia warrants that the physical media on which the software is provided is free from defects in materials and workmanship under normal use for a period of thirty (30) days from the date of purchase. The Licensee's invoice shall be evidence of the date of purchase. Any implied warranties on the software are limited to thirty (30) days from the date of purchase. Some states do not allow limitations on duration of an implied warranty, so the above limitation may not apply to the Licensee in this case. All programs and accompanying materials are provided "as is".

8. No Liability for Consequential Damages

Neither Arturia nor anyone else involved in the creation, production, or delivery of this Product shall be liable for any direct, indirect, consequential, or incidental damages arising out of the use of, or inability to use this Product (including without limitation, damages for loss of business profits, business interruption, loss of business information and the like) even if Arturia was previously advised of the possibility of such damages. Some states do not allow limitations on the length of an implied warranty or the exclusion or limitation of incidental or consequential damages, so the above limitation or exclusions may not apply to the Licensee in this case. This warranty gives the Licensee specific legal rights, and the Licensee may also have other rights which vary from state to state.