

USER'S MANUAL

JUPITER-8V



ARTURIA®
YOUR EXPERIENCE • YOUR SOUND

PROGRAMMING:

Nicolas Bronnec
Fabrice Bourgeois
Gavin Burke
Vincent Travaglini
Jean-Michel Blanchet
Philippe Wicker
Cristian Kreindler
Damien Vanderbeyvanghe
Thomas Diligent
Robert Bocquier

MANUAL:

Thomas Diligent (English version)
Christiaan de Jong (English version)
Houston Haynes (English version)
Richard Phan (English version)
Jean-Michel Blanchet (French version)
Antoine Back (French version)
Kenta Sasano (Version japonaise)
Kiriko Ishida (Version japonaise)
Tomoya Fukushi (Version japonaise)

DESIGN:

Yannick Bonnefoy (Beautifulscreen)
Elisa Noual

SOUND DESIGN:

Jean-Michel Blanchet
Thomas Binek (Tasmodia)
Stephan Muësh (Rsmus7)
Celmar Engel
Ruff & Jam
Katsunori Ujiiie
Sato Fujimori
Richard James
Nori Ubutaka

© ARTURIA SA – 1999-2014 – All rights reserved.
30, Chemin du Vieux Chêne
38240 Meylan
FRANCE
<http://www.arturia.com>

Information contained in this manual is subject to change without notice and does not represent a commitment on the part of Arturia. The software described in this manual is provided under the terms of a license agreement or non-disclosure agreement. The software license agreement specifies the terms and conditions for its lawful use. No part of this manual may be produced or transmitted in any form or by any purpose other than purchaser's personal use, without the express written permission of ARTURIA S.A.

The mark "Jupiter-8V" and "Roland" are property of Roland Corporation. The Jupiter-8 interface is also owned by Roland Corporation, the design and model being registered trademarks. All other products, logos or company names quoted in this manual are trademarks or registered trademarks of their respective owners.

November 2014 edition

Thank you for purchasing the ARTURIA Jupiter-8V!

In this package you will find:

- This paper manual for the Jupiter-8V
- One CD-ROM containing the Jupiter-8V installer for MAC OSX and Windows XP/Vista/7
- The registration Card

Carefully store your card!

In order to be able to use the software, you have to register your product. By registering, you identify yourself as the legitimate owner and will be sure to receive the latest news and updates for your product. After registration, you will receive a user ID and password in order to access a protected area on our site. It also puts you on our user notification list, so that you can be the first to know when there are updates or new product offers.

New features in Jupiter-8V

Features

- MIDI Control Assignment Improvement
- V Series standalone

Bug fixes

- Sluggish GUI on Mac OS X 10.5 (Leopard)
- Effect GUI update (was showing wrong settings)
- Fixed crash with arpeggio
- Fixed crash with Sound Map
- Unison improvement
- Fixed issues with modulation wheel

Platform requirements

- Added support for 64-bit VST and Audio Unit
- Added support for Pro Tools 9 & 10
- Added support for Mac OS X 10.7 (Lion)
- Dropped support for PowerPC computers
- Dropped support for Mac OS X 10.4

New features in Jupiter-8V 2.0

If you already own Jupiter-8V, version 2 includes the following changes:

- "Sound Map" graphical preset browser added
- RPN "pitch bend range" message is now recognized
- NRPN midi controls can be used for automation
- Increase of overall volume
- Switched to eLicenser Protection
- Fixed issue related to modulation wheel in Pro Tools (MAC OSX)
- Fixed issue related to triangle signal amplitude
- Miscellaneous fixed issues

Table of contents

1	INTRODUCTION	8
1.1	Roland/Jupiter-8 Story	8
1.2	TAE®	12
1.2.1	Aliasing-free oscillators	12
1.2.2	A better reproduction of analog oscillator waveforms	12
1.2.3	Direct Filter Circuit Modeling	14
2	ACTIVATION & FIRST START	15
2.1	Register & Activate	15
3	QUICK START	16
	Structure of the Jupiter-8V	16
3.1	Using the presets	17
3.1.1	Selecting the presets	17
3.1.2	Editing the presets	19
3.2	The 4 main parts of the Jupiter-8V	20
3.3	Overview of the Jupiter-8V user interface	21
3.4	The (Advanced) Modulations section	23
3.4.1	Creating a melodic sequence with the SEQUENCER	24
3.4.2	Create progressive modulations with the GALAXY unit	26
3.4.3	Control parameters with the Keyboard unit	28
3.5	The Effects	29
3.6	The "Patch" section of the effects	31
3.6.1	The chorus	31
3.6.2	The delay	32
3.7	Realtime controllers and MIDI assign	33
4	A UNIQUE SYNTHESIZER, WHY ?	35
4.1	The Roland Jupiter-8	35
4.2	The Arturia Jupiter-8V	35
5	THE INTERFACE	37
5.1	Tool bar	37
5.2	Using the presets	38
5.2.1	The types of presets	38
5.2.2	Selection of a preset PATCH or PROGRAM	38
5.2.3	Creating a new preset	41
5.2.4	Save a user preset	41
5.2.5	Save a user preset using the "Save as" option	41
5.2.6	Delete a preset	42
5.2.7	Import / Export a preset bank	42
5.3	Using the controllers	43
5.3.1	Knobs	43
5.3.2	Buttons	44
5.3.3	Switches	44
5.3.4	Pitch Bend wheel	44
5.3.5	Modulation button	45
5.3.6	Virtual keyboard	45
5.3.7	LCD Screen	45
5.3.8	MIDI Control	46

5.3.9	The preference screen	49
5.4	The Sound Map	50
5.4.1	The MAP main interface	51
5.4.2	The Sound Map overview	52
5.4.3	The LIST preset manager	55
5.4.4	The COMPASS morphing interface	56
6	THE DIFFERENT MODULES	58
6.1	The original Jupiter-8	58
6.1.1	The oscillators ("VCO 1 and 2")	59
6.1.2	The mixer ("VCO1 / VCO2")	61
6.1.3	The filter ("VCF")	61
6.1.4	The Amplifier ("VCA")	63
6.1.5	The ADSR Envelopes	64
6.1.6	The LFO	65
6.1.7	The VCO modulator	65
6.1.8	The LFO MODULATION, PORTAMENTO and BEND section	66
6.1.9	The pitch bend wheel and LFO MOD button	67
6.1.10	The Master Tune section	67
6.1.11	The arpeggiator ("ARPEGGIO")	68
6.1.12	The keyboard assign section ("ASSIGN MODE")	68
6.1.13	The play modes selection ("KEY MODE")	69
6.2	Step Sequencer	70
6.2.1	The transport	70
6.2.2	Edit the sequence	71
6.2.3	Outputs	72
6.3	Galaxy	73
6.4	Voice Effects	74
6.4.1	Chorus /Flanger	74
6.4.2	Distortion	75
6.4.3	Parametric EQ	76
6.4.4	Phaser	77
6.4.5	Ring Mod	78
6.5	Patch Effects	79
6.5.1	Chorus/Flanger	79
6.5.2	Stereo Analog Delay	80
6.5.3	Reverb	80
6.5.4	Dual Phaser	81
7	SOME ELEMENTS OF SOUND DESIGN	82
7.1	A polyphonic violin preset made with the Jupiter- 8 V	82
7.2	Arpeggiated sounds	85
7.3	A sequence with the Jupiter-8V	89
8	MODES OF OPERATION	93
8.1	Standalone	93
8.1.1	Launch the application	93
8.1.2	Configuration of the instrument	93
8.2	VST 2	94
8.3	VST 3	95
8.4	RTAS	95
8.5	AU	95
8.6	64 bit compatibility	95
8.7	Use in Cubase/Nuendo (VST)	95
8.7.1	Instrument use in VST mode	95
8.7.2	Rescan the plug-in directory in Cubase	96
8.7.3	Saving of presets	96

8.8	Using in Pro Tools (RTAS)	97
8.8.1	Opening of the plug-in	97
8.8.2	Saving the presets	98
8.8.3	Automation under Pro Tools	98
8.9	Using in Logic, Mac OS X (AU)	98
8.10	Using in Ableton Live (AU and VST)	99
9	ARTURIA JUPITER-8V - LICENSE AGREEMENT	100

1 INTRODUCTION

1.1 ROLAND/JUPITER-8 STORY

The history of Roland is intimately tied to the personal story of its founder, Mr Ikutaro Kakehashi.

When he was just 16 years old, the young Mr Kakehashi noticed there was no watch or clock industry in post-war Japan. He therefore understood there was a thriving business to develop repairing existing timepieces.¹

Mr Kakehashi found a part-time job in a watch repair store, but he quickly felt frustrated with the pace at which things were progressing. In the traditional Japanese organization of work, becoming a master in any technical area would take a seven-year apprenticeship. Consequently he left after a few months, bought a book on how to repair watches and set up the "Kakehashi Watch Shop".

This first venture happened to be so successful that he quickly decided to expand and turn his enthusiasm for music into business. It became legal at that time to have a short-wave radio and to listen to foreign broadcasts. While he scanned the airwaves for new music, Mr Kakehashi learned the basics of how radios operated. He then used broken sets to create working units. His repair shop started to repair broken radios in addition to clocks and watches.



¹ It is remarkable that a man named Mr Torakusu Yamaha had also started out as a watch repairer. In fact the same is true of Matthias Hohner, the founder of Hohner. Even the Hammond Organ Company started out as a sub-division of the Hammond Clock Company.

In 1954 Mr Kakehashi opened an electrical goods and repair shop by the name of "Kakehashi Musen". - Later the name was to be changed to Ace Electrical Company. His initial goal was to produce an electronic instrument capable of generating simple monophonic melodies, and so he ended up building a Theremin. Looking for a new challenge, he later built a four-octave organ using parts from a reed organ, bits of telephones, and simple transistor oscillators. In 1959, he designed and built a Hawaiian guitar amplifier, but he also went on with his further organ developments.

On the 18th of April 1972, Mr. Kakehashi established the Roland Corporation.

The first synthesizer from Roland was also Japan's first synthesizer. The SH1000 came to the market in 1973, just before the Korg 700 did. It was a remarkable instrument, offering 10 preset tones selectable from colored tabs. You could add vibrato, growl and portamento to modify the sound.



The System 100, launched in 1975, is another Roland monosynth that would become sought-after long after production stopped. The System 100 consisted of five semi-modular products. These were the 101 Synthesizer, the 102 Expander, the 103 Mixer (including a simple reverb), the 104 Sequencer, and the 109 Monitor Speakers. These units fit together to produce a system that sounded really interesting.



The first results from 1976's expansion in the development team, led to an explosion in Roland's product range. There were more synthesizers, a piano, more speaker systems and some now-classic instruments that included the Jupiter-4 Compuphonic polysynth. The Jupiter-4 was the company's first true polysynth. It used Roland's trademark chorus and three Unison options that made it a powerful monosynth. There also was an excellent arpeggiator.



By the end of the 1970s, Roland established itself as a major manufacturer, and in 1981 Mr. Ikutaro Kakehashi opened four new companies in three months. Roland UK, Roland GmbH and Musitronic AG in Switzerland. He also established a new Japanese division called AMDEK (Analogue Music Digital Electronics Kits)

Back to the early 80's, the Prophet 5 and Oberheim OB series dominated the polyphonic synthesizer market. Having that in mind the Jupiter-8's success, initiated in 1981, took every one by storm.

But what made the Jupiter-8 so successful? Well, in terms of sonic possibilities, it complemented its competition by bringing something different. The Jupiter-8 was capable of creating very versatile sounds. You could easily make "fat" or "crystal" sounds with it. In fact, the Jupiter-8 sounded the way it looked, 'sleek and polished'. Offering oscillator sync, cross modulation, a switchable 12dB/24dB filter and polyphonic portamento, the sound design opportunities were endless. You could easily save and load patches via its cassette interface. Even a superb arpeggiator was included. And last but not least, the Jupiter 8 was more reliable than its competition, and the sound was more consistent from model to model. Therefore it was very attractive for stage and studio use. In 1982, Roland released an upgraded Jupiter-8, the JP8A. It upgraded the Jupiter-8 with a number of enhancements including an improved DAC with a higher resolution of the auto-tuning system from 12- to 14-bit, plus a brighter LED screen. The Jupiter-8 has become one of the most revered of all synthesizers.



The electro-pop community became quickly convinced by the qualities of the Jupiter-8. "Relax" by Frankie Goes to Hollywood was produced incorporating a Jupiter 8, and players such as Vince Clarke, Howard Jones, John Foxx, and Martyn Ware were also using it. The path to classic status of the Jupiter started there.

Other artists that have used The Jupiter-8 include: Tangerine Dream, Underworld, Jean Michel Jarre, Depeche Mode, Prince, Gary Wright, Adrian Lee, Heaven 17, Kitaro, Elvis

Costello, Tears for Fears, Huey Lewis and the News, Journey, Moog Cookbook, Yes, Devo, Freddy Fresh, Simple Minds, Jan Hammer, and BT.

In the early 80's Roland and Sequential Circuits combined forces to create the MIDI protocol. The technology was derived from Roland's earlier DCB bus Format. MIDI is still being used today with great success. In 1982, Roland launched the Jupiter-6, the first synthesizer including the MIDI protocol on board. This new synthesizer was introduced as an enhancement of the Jupiter-8.



In 1982 Roland also released the TB303 Bass line. Initially marketed as a "computerised bass machine", the little silver box and its companion, the TR606 "Drumatix", were intended for use as replacements for a bass guitarist and a drummer. The TB303 had a very characteristic filter, and a built-in sequencer.

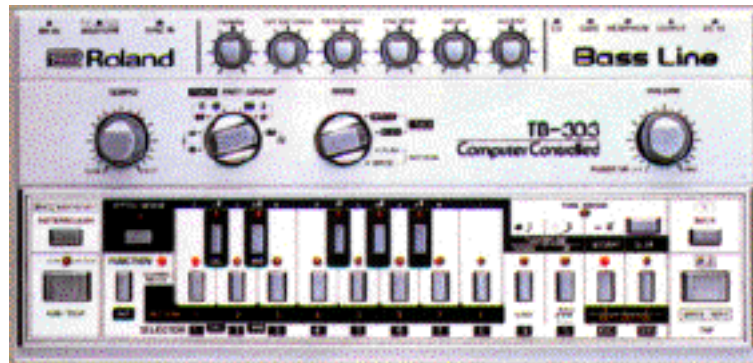

In 1984 there was the introduction of three synthesizers: the Juno 106, the JX8P and the JX10P. The last one was the replacement for the Jupiter-8. Unfortunately, the JX10 was never destined for the same success as the Jupiter 8.



It was the introduction of COSM and the "V" products in 1995 that set the future direction for Roland. Mr. Kakehashi and his teams had recognized that digital signal processing and physical modeling were the future of the electronic audio industry. Roland applied these technologies to a broad range of products. From sound modules and dance-oriented groove boxes to their most expensive digital mixers and audio workstations, Roland remains at the forefront of synthesizers and electronic music.

1.2 **TAE®**

TAE® - True Analog Emulation - is Arturia's outstanding technology dedicated to the digital reproduction of analog circuits used in classic analog synthesizers.

The Jupiter-8V benefits from an enhanced version of TAE®, optimizing CPU allocation and memory usage, while being even more accurate than in previous products.

When implemented in software code, TAE®'s algorithms guarantee authentic emulation of hardware specifications. This is why the Jupiter-8V, and all of Arturia's virtual synthesizers, offer an unparalleled quality of sound.

TAE® combines four major advances in the domain of synthesis:

1.2.1 **Aliasing-free oscillators**

Standard digital synthesizers produce aliasing in high frequencies, and also when using Pulse Width Modulation or FM.

TAE® allows the production of totally aliasing-free oscillators in all contexts (PWM, FM...), and at no extra CPU cost.

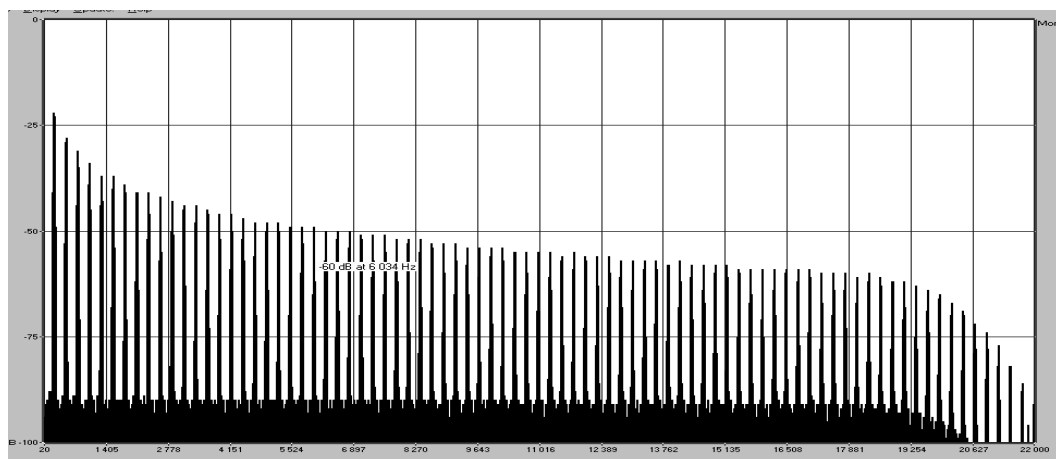

Linear frequency spectrum of the Jupiter-8V oscillator made with TAE

1.2.2 **A better reproduction of analog oscillator waveforms**

The waveforms produced by the oscillators in analog synthesizers are marked by the presence of a capacitor in the circuits. The discharge of the capacitor results in a light bend in the original waveform (notably for saw tooth, triangular and square waveforms). TAE® allows the reproduction of this capacitor discharge. This is the analysis of the

Roland Jupiter 8 waveform, and that of the Jupiter-8V. They are both equally deformed by the low-pass and high-pass filtering.

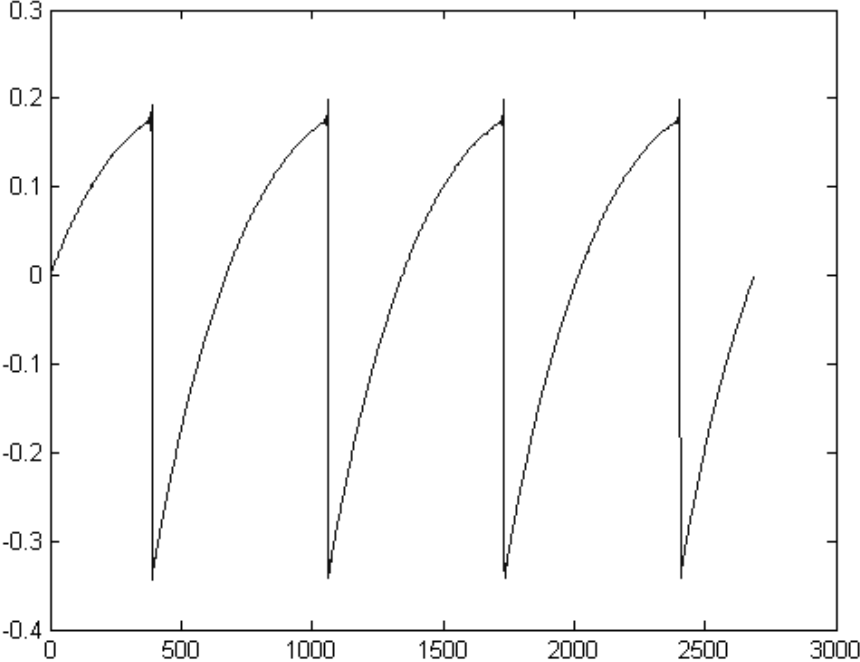

Temporal representation of a "saw tooth" waveform of the Jupiter 8

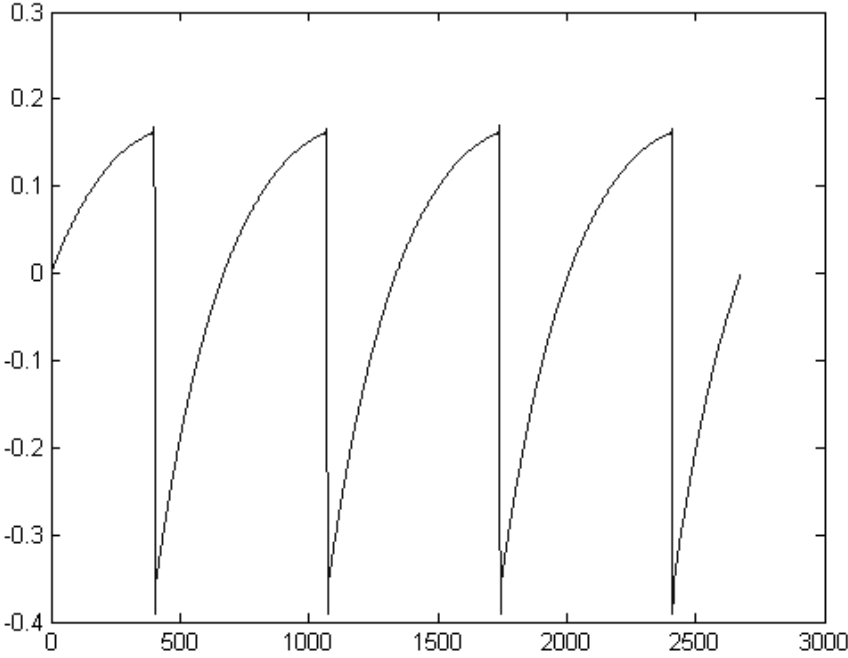

Temporal representation of a "saw tooth" waveform reproduced by the Jupiter-8V

What's more, the hardware analog oscillators were unstable. In fact, their waveform varies slightly from one period to another. If we add this to the fact that the starting point for each period (in Trigger mode) can vary with the temperature and other environmental conditions, we find another one of the characteristics that contributed to the typical sound of vintage synthesizers.

TAE® reproduces the instability of oscillators, bringing a fatter and "bigger" sound.

1.2.3 Direct Filter Circuit Modeling

Due to advances in computer processing power, the Jupiter-8V can now employ direct filter modeling techniques to achieve unprecedented accuracy in the emulation of a hardware synthesizer's filter. By modeling the operation of the individual hardware components of the filter circuit, the warm nuances synonymous with analog sounds are recreated. This graph is a frequency domain plot as just a single example of direct circuit modeling in action; it shows the generation of harmonics at multiples of the resonant frequency, for both the Arturia Jupiter-8V and the Roland Jupiter-8. These harmonics are characteristic of the hardware synthesizer's filters and are due to the non-linear behavior inherent in its analog circuitry. The harmonics generated add to the richness and warmth of the sound produced by the filter. As a result of the direct recreation of this analog circuitry, the same characteristics of the sound are present, thus giving the user a truly analog sound.

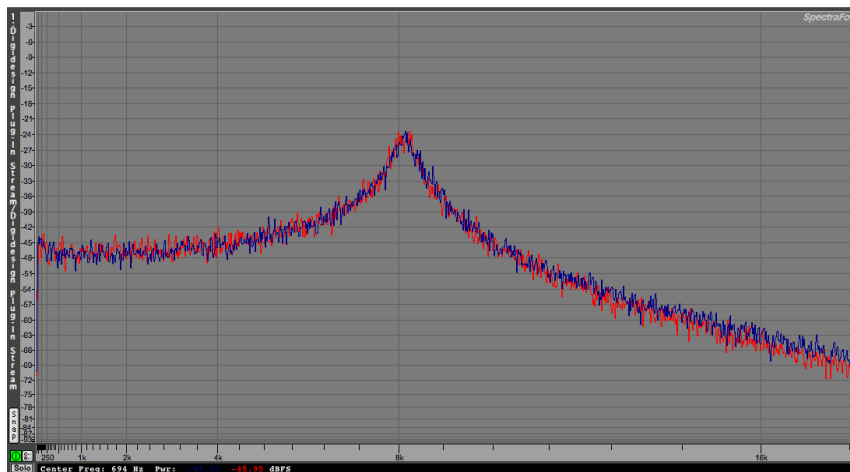

Comparison of Harmonics generated by the filter circuits of the Arturia Jupiter-8V and the Roland Jupiter-8

2 ACTIVATION & FIRST START

Jupiter 8 V works on computers equipped with Windows 7 or 8 and Mac OS X 10.7 or later. You can use the stand-alone version or use **Jupiter 8 V** as an Audio Units, AAX, VST2 or VST3 instrument.



2.1 REGISTER & ACTIVATE

Once the Jupiter 8 V has been installed, the next step is to register the software.

The registration process will require you to enter the serial number and the unlock code you received with the product.

In order to proceed, go to this web page and follow the instructions:

<http://www.arturia.com/register>

Note: If you don't have an Arturia account yet, you will need to create one. The process is quick, but it does require that you can access your e-mail address during the registration process.

Once you have acquired an Arturia account you will be able to register the product.

3 QUICK START

This chapter will allow you to familiarize yourself with the general functioning of the Jupiter-8V. This is a summarized presentation of the different parts of the synthesizer. You will find specified descriptions and details of all the parameters and screenshots in the following chapters.

Chapter 9, entitled "Some Elements of Sound Design", is particularly aimed at users that have no experience with a subtractive synthesizer, and wish to obtain basic knowledge in this domain.

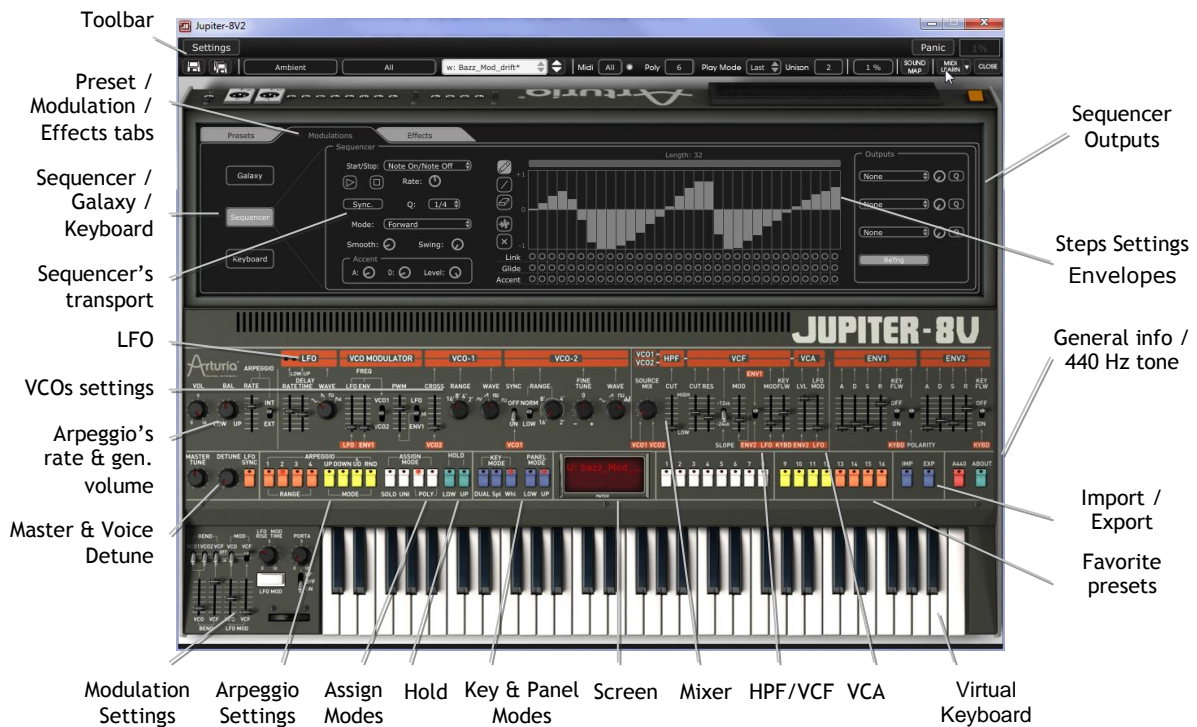

The Jupiter-8V interface

STRUCTURE OF THE JUPITER-8V

The structure of the Jupiter-8V allows you to play two tones at once (called "Lower" and "Upper" Programs in the terminology of the Jupiter-8). You can play the keyboard in three different ways:

- "DUAL": allows you to play the two Programs "Lower" and "Upper", simultaneously on the entire keyboard.

- "Split": allows you to play the two Programs "Lower" and "Upper" divided separately over the two zones of the keyboard.
- "Whole": allows you to play the "Upper" Program over the full range of the keyboard.

These three methods allow you to create very rich sonic combinations.

3.1 USING THE PRESETS

3.1.1 Selecting the presets

The Jupiter-8V has two kinds of presets:

3.1.1.1 The Patches

The "PATCH" presets can save:

- The configuration of the keyboard (methods "Whole", "Dual" et "Split")
- The division zones of the keyboard ("Split")
- The types of playing (SOLO, UNISON, POLY1 and 2)
- The midi configuration of the synthesizer
- The settings of the arpeggiator
- The settings of the "Modulation" zone ("BEND", "MOD", "PORTAMENTO"...))
- The setting of the master effect (delay, chorus).

3.1.1.2 The Programs

The "PROGRAM" presets are the composed sounds of the Jupiter-8V. They contain:

- All the synthesis parameters,
- All the parameters of the Galaxy module and the sequencer.
- The parameters of the voice effects ("Voices Effects")
-

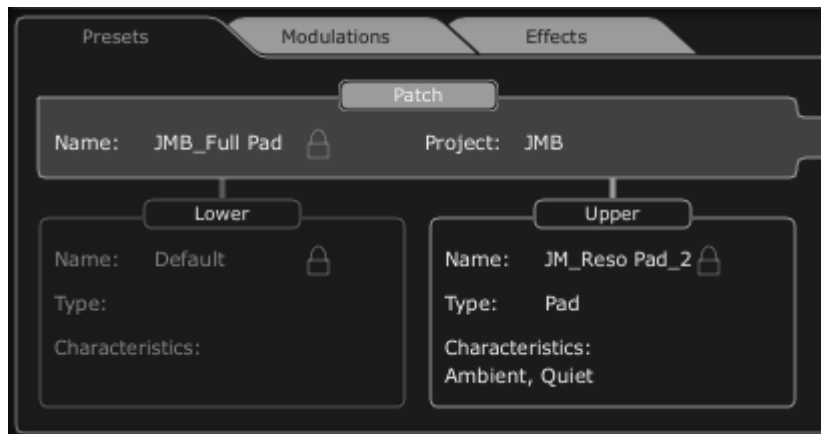

Preset organization of the Jupiter-8V

To familiarize yourself with the different included sounds of The Jupiter-8V, we will select the preset "Full_Pad" situated in the bank "JMB / Pads/ JMB_Full_Pad".

- ▶ First, click on the **OPEN** button, on the toolbar, to open the expansion interface.
- ▶ Then, click on the button "Presets" situated above the programming interface of the Jupiter-8V. This screen presents the interface in which to choose different presets.



Click on the "presets" tab

- 2 filtering lists allow you to select the search options that will help you find your preset. If you click on the first one, you will see an unfolding menu appear indicating the list of the available banks.
- ▶ In the first filter, choose "Project" then select "JMB".
- ▶ In the second filter, choose "Mode" then select "Whole".
- ▶ Finally select the preset named "JMB_Full_Pad" preset in the result list.
- ▶

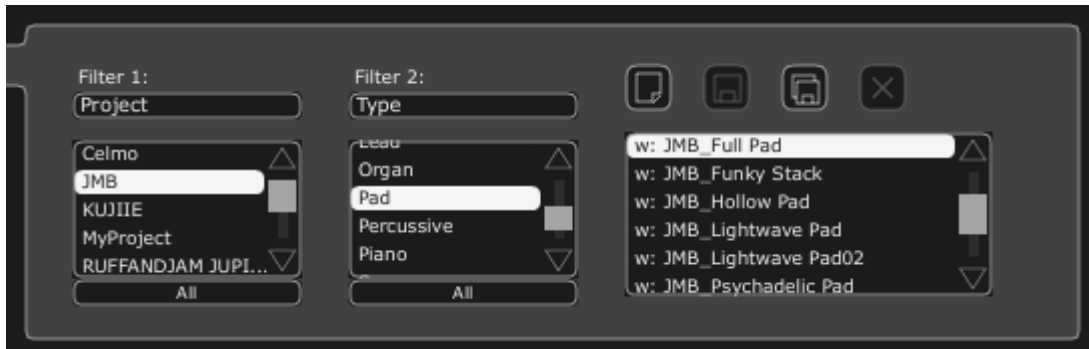

Select the preset "JMB_Full Pad"

It is also possible to directly select the presets on the toolbar situated on the top of the Jupiter-8V interface:

- ▶ Click on the one of the first 2 tabs situated on the tool bar to choose a filtering criteria – the name of the project for example.
- ▶ Then click on the third tab to choose the name of the preset that you wish to edit.



Choose a preset patch from the toolbar

The Jupiter-8V is delivered with 400 factory presets that will allow you to become familiarized with the tones of the synthesizer.

 It is also possible to show all the presets when choosing the option "All" in the bank. For example, to see the bass presets, click on "All" in the selection of the bank and then click on "Bass".

3.1.2 Editing the presets

To begin, we will start with a very simple manipulation.

- ▶ Modify the brightness of the sound "Full_Pad" with the "CUT" slider (VCF for Voltage Controlled Filter). To do this, push or pull the slider. The timbre of the sound will become more or less "brilliant". Tune this slider to your liking.

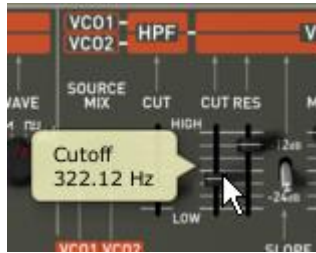

Change the brightness of the sound

- ▶ In the same way, you can increase the range of oscillator 2 (VCO2 for Voltage Controlled Oscillator) by an octave with the knob "RANGE". Choose a value of "4".



Tuning the second oscillator

While changing these first settings, you have modified the preset "Full_Pad". Now you will be able to save the sound that you have just created.

- ▶ To choose another destination for this sound, click on the icon "Save As" , then choose your location. For example, create a new Project while writing your name in the display.
- ▶ Click on the display again to give the name that you wish to this new Patch.

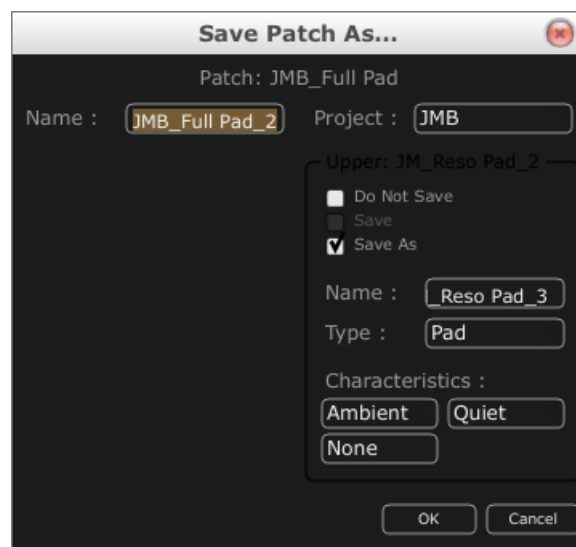

Saving a patch

- ▶ To save a user preset ("Users"), click on the save button "Save", in tool bar: The new settings will be saved in the framework of the currently selected preset without changing the name. If the modified preset is a «factory preset» (factory), it will not be overwritten and the window «save as» appears to create a user preset.

 It is important to change the name of a preset in order to create a new one! Then the name of the preset that has been edited will be modified.

3.2 THE 4 MAIN PARTS OF THE JUPITER-8V

The Jupiter-8V offers 4 main parts:

- The "Jupiter-8V" interface represents the interface of the original;
- The "PRESETS" manager section;
- The "SEQUENCER / GALAXY" interface to access the SEQUENCER and GALAXY modules;
- The "EFFECTS" interface to access the effects;

To open the extension panel of the Jupiter-8V, click on the  then choose one of the 3 tabs available.

3.3 OVERVIEW OF THE JUPITER-8V USER INTERFACE

The interface of the Jupiter-8V has 54 synthesis parameters and a programmer that allows you to navigate quickly through the 44 factory presets of the original machine. The knobs and associated switches to these parameters will allow you to create a nearly infinite variety of sounds.

These parameters consist of:

- 2 oscillators (VCOs) that deliver the basic audio signal thanks to the waveforms and allow the tuning of the sound (the frequency). VCO1 can produce triangle, saw tooth, variable pulse or square signals while VCO2 can produce sine, saw tooth, variable pulse or noise signals.
- A mixer to mix the 2 VCO's
- A non resonant high pass 6 dB/oct filter
- A resonant low pass 12/24 dB/oct filter
- An LFO
- 1 amplifier (VCA) allowing amplification of the signal between the filter to the stereo output.
- Two envelopes (ADSR) to modulate the low pass filter and the VCA



The synthesis parameters

See how to quickly create a polyphonic sound with the Jupiter-8V:

To be able to understand the principle of how to program the Jupiter-8V, we will take a very simple sound. Select the preset "UJ Brass" in the bank "KUJIIIE" / "Brass". The synthesis structure of this sound is relatively simple: the sawtooth waveforms of VCO 1 and 2 are active and their signals are directed through the low pass filter. Afterwards the signal is routed through the mixer, and finally into the amplifier. An ADSR envelope modulates the cutoff frequency of the filter and a second ADSR envelope modulates the volume of the amplifier.

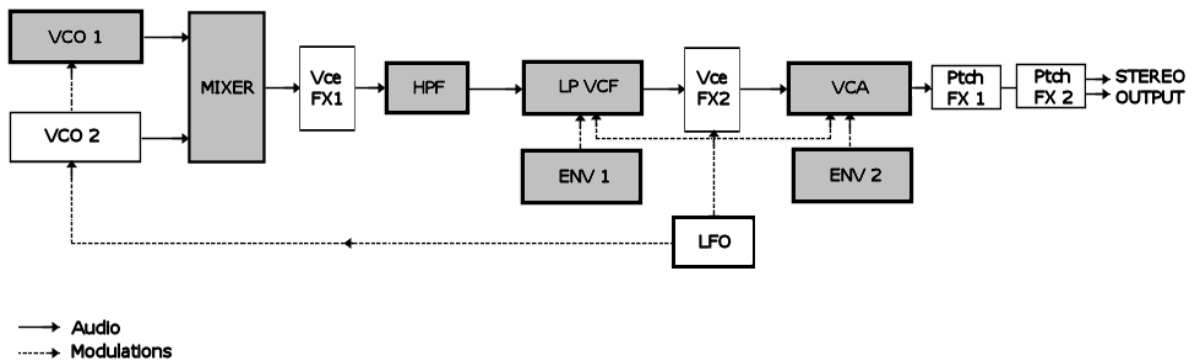

Signal path of the Jupiter-8V Start lowering the cutoff frequency of the low pass filter "VCF". A sound with less brightness will result.

- ▶ To do this, adjust the knob "Cutoff". (For fine tuning, use the right mouse button or [Alt]+click on Mac)
- ▶ Note that the cutoff frequency of the filter is also modulated by an ADSR envelope (Attack, Decay, Sustain and Release).



Lower the cut frequency of the VCF

- ▶ To hear the effect of the ADSR envelope on the cut frequency of the filter more clearly, increase the value of the resonance. This will amplify the filtering effect and the sound will begin to “ring”.

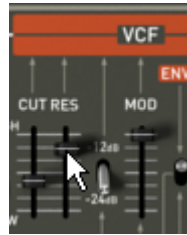

Increase the value of the resonance

- ▶ Change the length of the attack of this envelope (“Attack time” ENV1) so that filter rise time increases more or less quickly when a note is played.

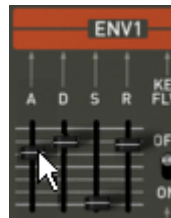

Increase the length of the attack

- ▶ In the same manner, change the value of the Decay; the filter frequency will decrease more or less quickly while you will play the keyboard.

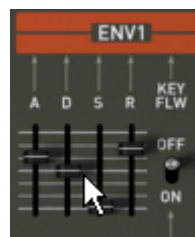

The filter envelope “Decay” parameter.

Carry out a short modification on the second “ADSR” envelop to modulate amplitude.

- ▶ Increase the “Attack” time of this envelope so that the volume of the sound increases progressively.

▶

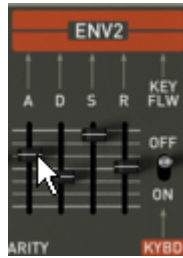

Increase the "Attack" time of the amplitude envelope.

- ▶ Don't forget to save your work by clicking on the "SAVE AS" button, situated on the Jupiter-8V toolbar.

3.4 THE (ADVANCED) MODULATIONS SECTION

In the "MODULATIONS" section, there are sources of additional modulations allowing an extension of the playing possibilities and of the synthesis. This section offers two types of interfaces: SEQUENCER is accessible while clicking on the "SEQ" button.

3.4.1 Creating a melodic sequence with the SEQUENCER

The sequencer is accessible by clicking on the "MODULATIONS" tab, situated on the expansion panel. Click on the "SEQUENCER" icon.

The sequencer is a 32-step "step sequencer". It allows the creation of several melodic lines (when one of the three available modulations is affecting the frequencies of the VCO) as well as creation of dynamic modulations of other parameters such as the cut-off frequency of the VCF or on the width of the square waveform of the VCO's.

It enables you to affect up to 3 simultaneous parameters.

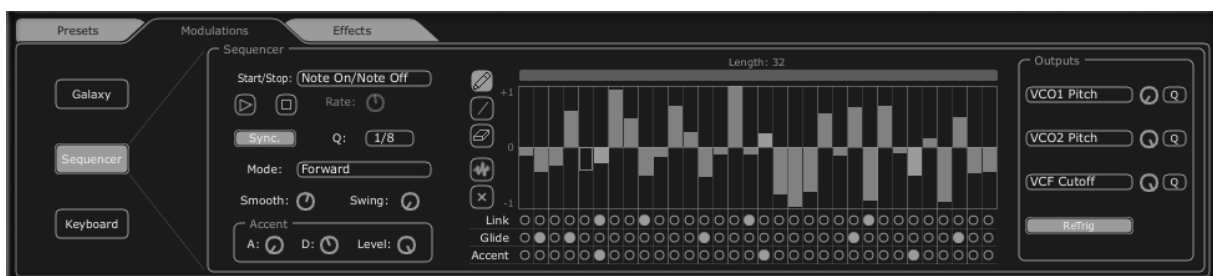

The step sequencer

In this chapter we will see how to create a simple melodic sequence.

- ▶ Click on the "MODULATIONS" tab, and then click on the "SEQUENCER" tab to bring up the interface.

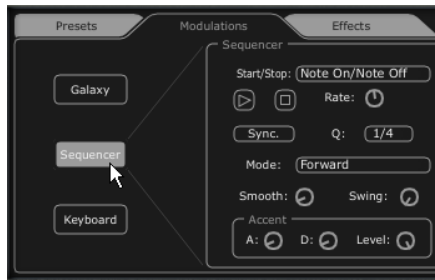

Click on the "SEQUENCER" button

- ▶ Connect the frequency of VCO1 to the first modulation output and click the "Q" button to activate the quantize factor by half-tones for the frequency values.

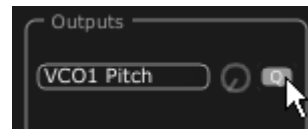
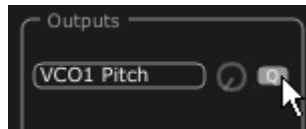

Set Sequencer Output 1

- ▶ Connect the frequency of VCF to the second modulation output and set the amount knob to let it blend in to your liking.
- ▶

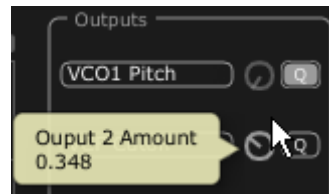
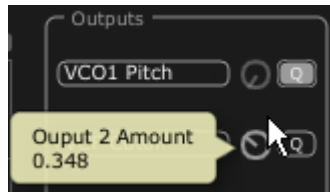

Set Sequencer Output 2

- ▶ Enabling "Retrig" button triggers envelopes at each steps of the sequence



Set Retrig

- ▶ To start the sequencer, set the "start/stop" mode to "Free running" and click on "Play"

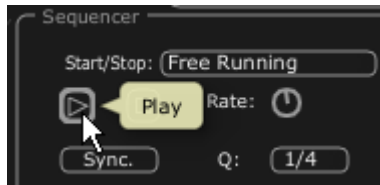

Play Sequence

- ▶ Set the value of each step by clicking and dragging the 16 bars up or down to create your melody.

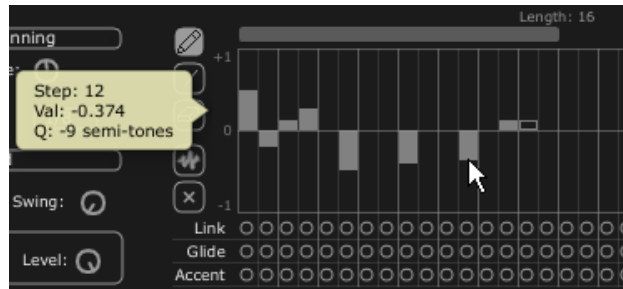

Set the value of each step

- ▶ Set the speed of the sequencer with the "Rate" knob.

 If it is synchronized with an external sequencer like **Cubase** or Logic Audio for example, use the "**Quantization**" ("**Q**") parameter, situated next to the "sync" button in the same section. Choose one of the tempo divisions to set the speed to your likings.

To add additional punch to the sequence, place accentuations on certain notes ("Accent" - envelopes "Attack and Decay" are effective on the cutoff frequency of the VCF):

- ▶ Click on the "Accent" button and apply it to the steps you want to accentuate.
- ▶ Set the intensity of this modulation with the "Level" knob.
- ▶ Set the attack time "A" and decay time "D" of the envelope to your convenience

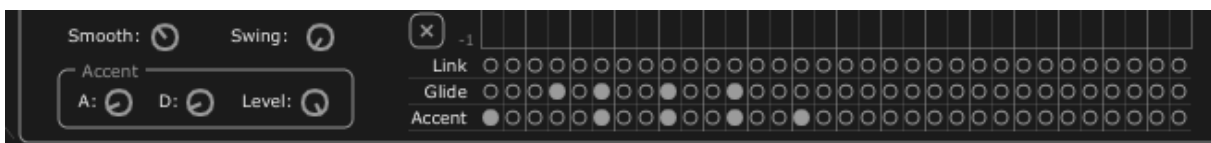

The accent settings

- ▶ There is also the option to add alternative quantization («SWING») to the sequence. This quantization can be useful for the composition of a piece of «house music», for example.

3.4.2 Create progressive modulations with the GALAXY unit

Galaxy allows creating very complex modulations thanks to the interaction of 3 LFOs. The first two LFOs allow inter-modulation with a different parameter on the X and Y axes.

They are represented on the graphical interface of the unit. A third LFO allows modifying the alpha angle between the 2 X and Y axes.

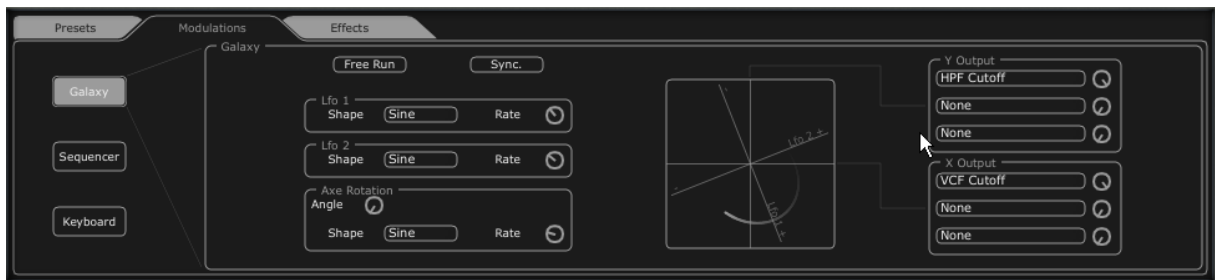

The «GALAXY» module

Click on the "MODULATIONS" tab then on the "GALAXY" tab to show the

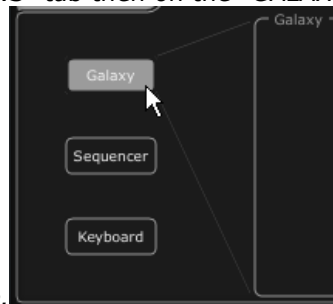

interface.

Click on the "GALAXY" tab

Choose a parameter (for example, the HP VCF Cutoff) for the X axis, then adjust the speed



parameter of the LFO to your liking.

Choose a destination for the modulation of the X axis.

- ▶ Choose a parameter for the Y axis (for example the LP VCF Cutoff) then adjust the speed parameter of the LFO to your liking.
- ▶



Adjust the speed of the LFO of the Y axis

See how to apply a modulation to automate the movements of the axis. This will shift the position in a cyclical way. You will obtain unusual and very progressive modulations thanks to this unit.

You also can modify this angle manually thanks to the "ANGLE" knob.

- ▶ Choose the triangle waveform then adjust the speed parameter of the LFO to your liking.

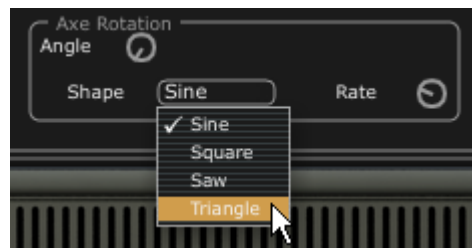

Choose the triangle waveform for the α (alpha) angle

3.4.3 Control parameters with the Keyboard unit

The Keyboard unit enables you to control parameters via velocity and aftertouch.

- ▶ Click on the "MODULATIONS" tab then on the tab called "KEYBOARD" to show the interface.

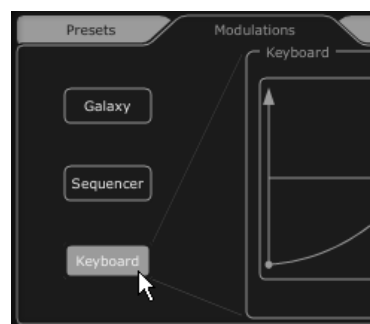

Click on the "KEYBOARD" tab

- ▶ Select the parameter to be controlled by the velocity and then set the amount knob to your liking.

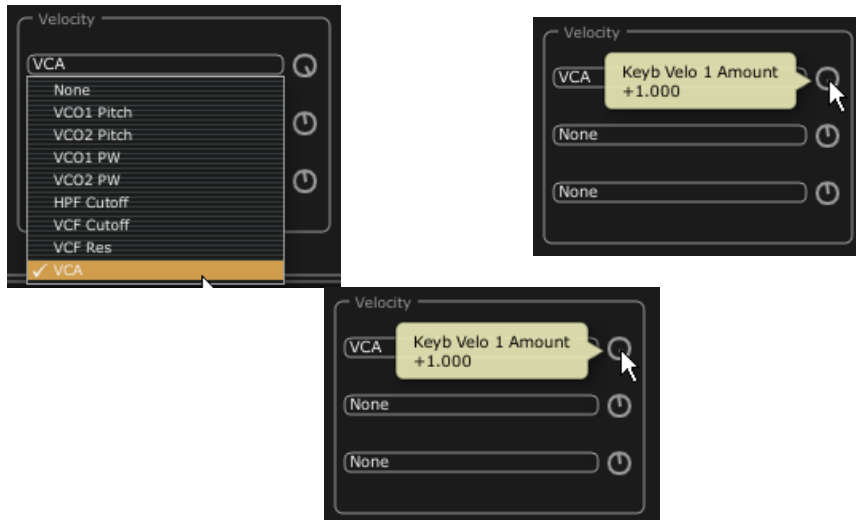

Choice of the modulation destination, setting its amount

- ▶ Customize how velocity modifies the selected parameters thanks to a curve. The X axis represents the amount of velocity while the Y axis represents the amount sent to the parameters. This curve can be controlled thanks to 3 points.

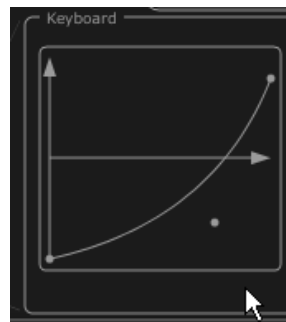

Customize the velocity curve

- ▶ You can do the same for the aftertouch.

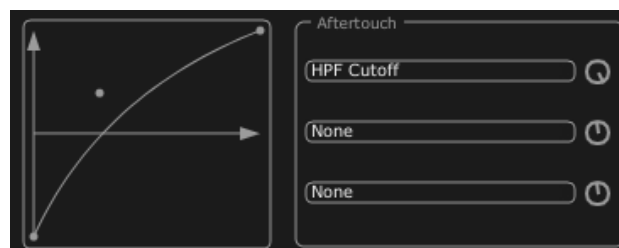

Customize the aftertouch curve

3.5 THE EFFECTS

The "EFFECTS" interface of the Jupiter-8V offers unique signal processing possibilities, allowing you to insert effects in the synthesis chain, between the VCO and the VCF and between the VCF and the VCA. These combinations allow you to create a wide variety of new sounds.

Additionally, you will be able to connect two effects "Patches" that are situated at the audio output of the synthesizer.



The interface of the effects

To familiarize yourself with this function, click on the "EFFECTS" button situated with the other tabs.

- ▶ Using the preset filters, choose the Project "JMB" / Type "Bass" / Preset "JMB_Bass01".
- ▶ In order to enrich the sound, the effect "Distortion" has been inserted between the VCO and VCF (Filter). Change this effect to "No Effect" and back to "Distortion" to observe the differences of sound.
- ▶

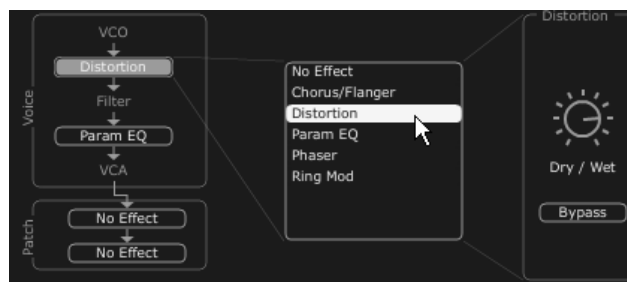

Choose the effect of "Distortion" in the effects menu.

The interface of the distortion effect is now on screen.

- ▶ Adjust the distortion amount with to the "Drive" knob and see the changes in the sounds as well as in the curve.
- ▶ Change modulation source and amount.
- ▶ Adjust the mix of Dry/Wet signals.



The "Distortion" effect

Place a second effect between the VCF and the VCA. Take the "Param EQ". Certain parameters of this effect will be modulated by the LFO in order to create an effect similar to phasing. The Param EQ is composed of 4 filters: Band 1 is a low shelving filter, Band 2 and 3 are middle peaking filters and Band 4 is a high shelving filter. They can be activated or deactivate by clicking on the "Band 1/2/3/4" buttons.

Adjust the volume of the frequency of "band 3" with the knob "G" (GAIN) or simply modify the

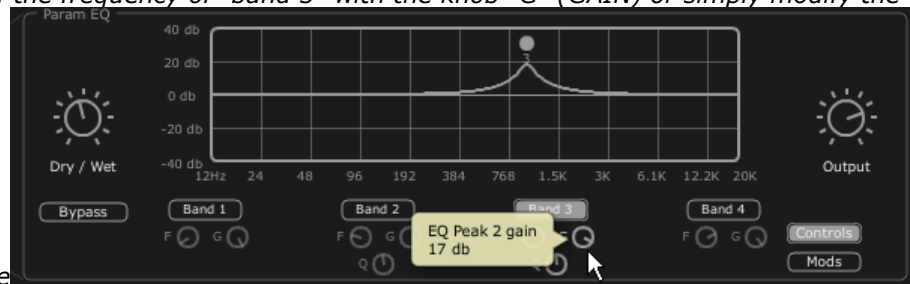

point in the gain curve

Set the volume of the frequency for "band 3"

- ▶ Apply a modulation on the frequency of band "3" with the LFO. To do that click on the button "Mods" situated on the right of the EQ interface. This will show you the possible modulation connections available.
- ▶ Click on the display situated next to "Band3" / "F" to open the menu of the modulation sources. Choose the "LFO". Increase the level of the knob "Modulation amount" situated next to the display to hear the modulation on the frequency of the band 3.

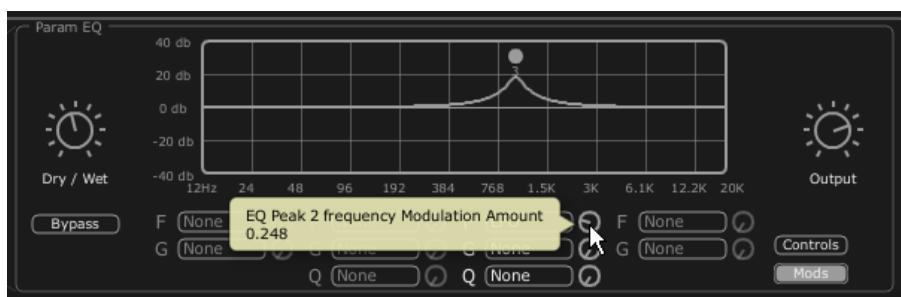

Increase the "Modulation amount" potentiometer

3.6 THE "PATCH" SECTION OF THE EFFECTS

The section of the "patch" effects allows you to add 2 master effects to your sound. They are accessible while clicking on one of the 2 displays situated down below to the left of the interface "Effects". Choose the "St Chorus" for the first effect and "St Delay" for the second one. The editor will appear to the right (as for the effects "Voices").

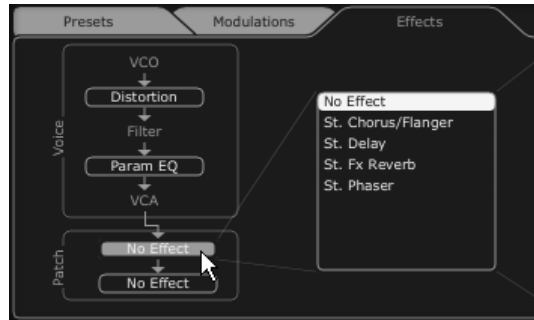

Click on the display "patch"

3.6.1 The chorus

The Chorus effect allows doubling the original sound with slightly out of tune copies in order to make a deeper and livelier sound. Three types of stereo chorus are available, from simple to very wide.

- ▶ Activate the "ON/OFF" button of the Chorus in the effects section, placed to right of the tool bar.

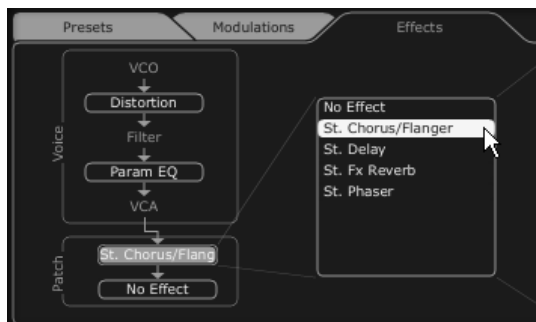

Activate the button "ON/OFF" of the Chorus

- ▶ Adjust the "Dry/Wet" knob of the Chorus in a manner that is balanced between the original sound and the treated sound.
- ▶ Next, turn the "Rate" knob of the Chorus to set the speed of the oscillations affecting pitch.
- ▶ Finally, set the stereo width of the Chorus by turning the "Spread" knob.



The settings of the chorus

3.6.2 The delay

The Delay is a stereo echo effect that adds space to your sound. It possesses independent settings for speed and the number of repetitions on the right and left side. Therefore it is possible to create a big number of rhythmic combinations between the repetitions. The speed of the Delay can also be synchronized to the MIDI tempo of your sequencer. Let's use the "JMB_Bass1" example again and see how to use the effect on this sound:

- ▶ Activate the "Delay" button on the tool bar. The effect is activated
- ▶ Set the "Dry/Wet" knob of the Delay in a manner to balance between the original and the treated sound
- ▶ Turn next the 2 knobs "TIME L / TIME R" to set the speed of the repetitions for the right and left side.
- ▶ It is also possible to set the number of repetitions (Feedback) for each stereo side ("Feedbk R" and "Feedbk L").

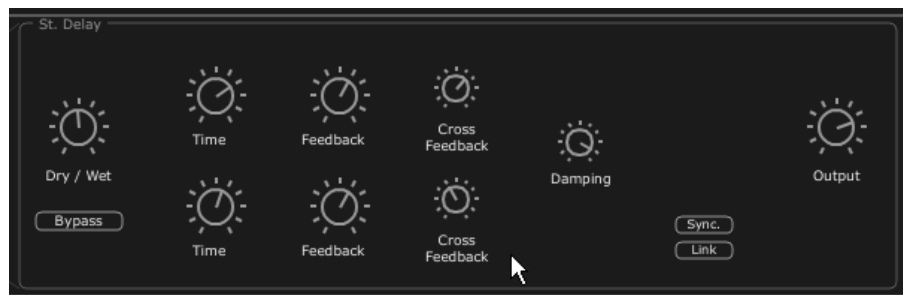

The settings of the delay

3.7 REALTIME CONTROLLERS AND MIDI ASSIGN

As its brilliant sounding ancestor, The Jupiter-8V is particularly adapted for playing in real time. One of the big evolutions in comparison with the original is the possibility to assign any knob of the Jupiter-8V to an external midi controller.

For example:

- ▶ Click on the "MIDI Learn" button

- ▶ Click on the knob "Cutoff". The MIDI assign option appears.
- ▶ Move the controller of your choice (the knob of modulation for example). The knob of the Jupiter-8V will begin moving at the same time.
- ▶ Then you will be able to record the movements of your MIDI controller in your MIDI sequencer or simply manipulate the sound in real time with your controller live.



"Cut-off" parameter waiting for the control to be assigned



assigned

LSB:35

*MIDI CC #81
MIDI NRPN MSB:16*

In addition to the "Learn" button, midi assignments can be set by clicking on the midi control number labels and "Use NRPN" checkbox.

To save the setting that we have just carried out during this chapter, click on the button "Save" situated on tool bar. ⚠ The MIDI settings will only be saved when you quit the application of the Jupiter-8V. This is the same with the stand alone version and the plug-in version as well.

4 A UNIQUE SYNTHESIZER, WHY ?

4.1 THE ROLAND JUPITER-8

The Jupiter-8 is capable of creating very versatile sounds. The Jupiter-8 sounds the way it looks, 'sleek and polished'. It offers oscillator sync, cross modulation, a switchable 12dB/24dB filter and polyphonic portamento. It also features a superb arpeggiator. The sound design opportunities are virtually endless.

The filter (VCF) structure is one of a special kind. It is composed of two independent filter units, a non-resonant 6 dB/Octave high pass filter and a resonant 12 or 24 dB/Octave low pass filter. The combination of the non-resonant high pass filter with the resonant low pass filter, enables creating very characteristic Roland style sounds. This structure can also be found on the Roland Juno series.

The Jupiter-8 is often considered the biggest and fattest of the Roland Jupiter family. The Jupiter-8 offers eight analog voices. The sound of the Jupiter-8 is often referred to as fat and crispy clear at the same time. The Fast envelopes make it possible to create punchy sounds. This is great for bass and stab sounds in particular. The colorful interface with lots of sliders and knobs is inviting for sound designers and producers. Furthermore, it was one of the first synthesizers that offered a keyboard split and layer possibility. In fact, the Jupiter-8 complemented its competition by bringing something different.

In 1982, Roland released an upgraded Jupiter-8, the JP8A. It upgraded the Jupiter-8 with a number of enhancements. The most noticeable changes were an improved DAC with a higher resolution of the auto-tuning system from 12- to 14-bit, and a brighter LED screen. The Jupiter-8 has become one of the most revered of all synthesizers.

The electro-pop community became quickly convinced by the qualities of the Jupiter-8. 'Relax', by Frankie Goes to Hollywood was produced incorporating a Jupiter-8, and players such as Vince Clarke, John Foxx, Howard Jones and Martyn Ware also used it enormously. The path to classic status of the Jupiter started there.

4.2 THE ARTURIA JUPITER-8V

Aside from recreating the original in every aspect, the Jupiter-8V adds many new functions which make it even more attractive to use. The Jupiter-8V offers various new editing possibilities which can result in sounds that were never heard before.

The galaxy module creates very complex modulations with interaction of 3 LFO's. The first 2 LFO's can each modulate a different parameter on a X/Y axis. The third LFO can be set to rotate the X/Y axis at a certain speed. This is beautifully visualized in the interface of the Jupiter-8V and enables a totally new dimension for sound design.

Furthermore the Jupiter-8V offers two connections of «Voice» effects. The connections of the effects can be made inside the synthesis chain, between the VCO and the VCF and between the VCF and the VCA. These effects can be modulated by the different available sources of modulations such as the LFO or the envelopes. Combinations of effects and

modulations provide the Jupiter-8V with even more sonic power. Two « PATCH » effect modules are available on the end of the synthesis chain. The two modules are placed on top of the output of the VCA, and cannot receive external modulations. Amongst these «PATCH» effects are a delay, reverb, flanger and a phaser.

Another addition is the sequencer which is a 32-step «step-sequencer» It allows the creation of several melodic lines as well as creation of dynamic modulations of different parameters such as the cutoff frequency of the VCF or the width of the square waveform of the VCO's.

There is a user friendly preset and patch structure for easy yet expandable management of the sounds. It is possible to add characteristics to sounds to be saved. This provides an easy and effective way to browse patches and find the most relevant one quickly.

As a matter of fact, every single setting can be saved and recalled in a heartbeat. This allows perfect integration with your project and saves a lot of time compared to the original Jupiter-8.

The Jupiter-8V delivers a sound that is full of character and highly editable. It can be the perfect companion on every kind of musical project, with the ease of use of the 21st century.

5 THE INTERFACE

5.1 TOOL BAR

The tool bar consists of an ensemble of essential icons for the Jupiter-8V organized from left to right allowing you to:

- Access drop menus offering filters with the following criteria:
 - Characteristics
 - Factory / User
 - Mode (Whole / Dual / Split)
 - Project
 - Type
- MIDI activity light
- Choice of MIDI channels:
 - All
 - 1 to 16
- The number of polyphonic voices
- Playing Modes:
 - Poly/Mono Low: when legato between two notes, the lowest note gets priority
 - Mono High: when legato between two notes, the highest note gets the priority
 - Mono Last: when legato between two notes, the last note played gets the priority
- Unison: number of voices
- CPU meter
- "Open Sound Map" button
- "MIDI Learn" combo button

"Open" and "Close" buttons (access to preset, advanced modulation and effects panels)



Tool Bar

5.2 USING THE PRESETS

The presets allow saving and recalling the sounds of the Jupiter-8V. A preset contains all the new settings of the various controllers to reproduce a sound. In the software version, just like on the original one, the presets are classified in two categories of presets: The "Patches" and the "Programs".

5.2.1 The types of presets

5.2.1.1 The patches

The "PATCH" presets can save:

- The modes of playing ("Whole", "Dual" or "Split")
- The settings of the keyboard ("Split")
- The types of playing (SOLO, UNISON, POLY1 et 2)
- The MIDI configuration
- The settings of the arpeggiator
- The modulation module settings ("BEND", "MOD", "PORTAMENTO"...)

The master effect settings (delay, chorus).

5.2.1.2 The Programs

The "PROGRAM" presets are composed of sounds from the Jupiter-8V. They contain:

- All the synthesis parameters,
- All the Galaxy, Sequencer and Keyboard parameters
- The voice effects parameters ("Voices Effects")

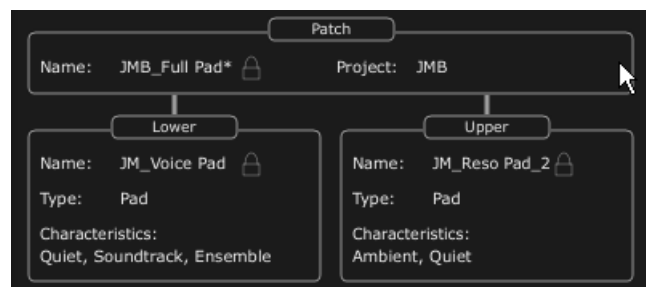

Patch/preset window

The Jupiter-8V is delivered with several factory sound banks. Of course, it is also possible to create sound banks yourself, containing any number of banks and presets. The factory sound banks are not directly modifiable. Nevertheless it is possible to modify a sound based on a factory preset and save it in a "user" bank.

Selection of a preset PATCH or PROGRAM

The Preset PATCH banks of the Jupiter-8V are permanently selectable from the left part of the toolbar.

You have two options to select a preset:

5.2.1.3 Select from the toolbar

5.2.1.4

The fastest way to select a preset is to click on the "preset" buttons on the toolbar. Two preset filter windows, situated on the left of the preset screen allow preset selection according to available criteria.



Select a preset from the toolbar

5.2.1.5 The "PRESETS" screen

5.2.1.6

The second solution is to use the "PRESETS" screen to select a preset PATCH or PROGRAM.

To do that, open the extension panel  (click on the button) situated on the left right of the tool bar.

Then, click on the "PRESETS" tab to open the presets page. This page offers you two possibilities.

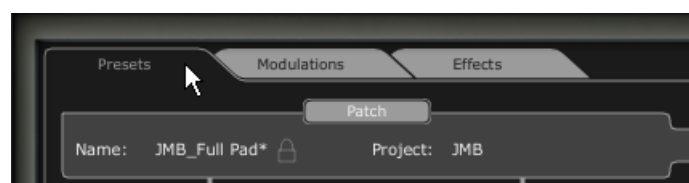

Click on the preset tab

This page shows two distinct sections:

- The left portion allows selection of presets by category (PATCH / PROGRAM Lower or Upper).
- The right portion allows searching with the help of two filter criteria.

Four buttons situated above the choice fields, allow you to create, save, save as or delete a preset.

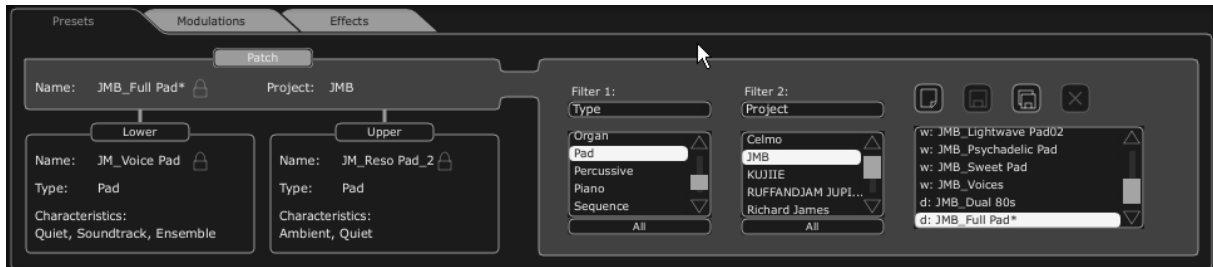

The Preset page

Once the filters criteria are set, you can select Patch presets in the resulting list on the right of the page. Click on "PATCH", then select criterion (for instance, Project: JMB, Type: Pad) and finally choose a preset in the list.



Selection of a preset from the same bank

To select a preset "PROGRAM" click on the "UPPER" or "LOWER" button. The name and the filter criteria of the preset are shown in the field above the button. A list of selection filters appears. After selection of the filter categories of interest, simply select the preset by clicking on the preset name.

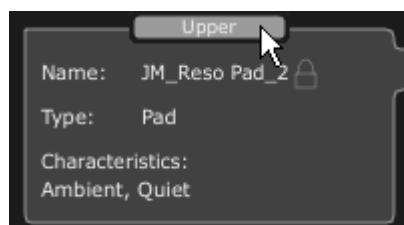

Click on the button "upper"

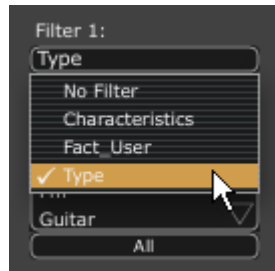

Selection of the filter criteria

The choice of filters is the same as with "PATCH" presets.

In the unfolding menu, the choice "No filter" is particularly useful to quickly pass through presets of the same type.

If a preset is modified, this symbol "*" will appear next to the name of the preset.

 The key mode must be in Dual or Split in order to get access to the Lower "Prog" part.

5.2.2 Creating a new preset

To create a new preset (PATCH or PROGRAM), click on the  button, the name: "New_Patch" or "New_Prog" will appear. Then you can work on the parameters of the sound, to save the sound under the same preset name while clicking on the save button. You can also change the name of the new preset by clicking on the name.

 The new preset will always be a patch of the type WHOLE by default. To change the preset mode, click on one of the two other types you would like to choose.

5.2.3 Save a user preset

To save your current settings of the preset, click on the "Save" button  on the toolbar.

5.2.4 Save a user preset using the "Save as" option

To save your current settings of the preset under another name, click on the «save as» button on the toolbar . A dialog window will appear. It will let you set the name of the preset PATCH and set the search filter type of the preset "PROJECT". Click on "OK" to save. At this point, the preset PROGRAM will not be modified, even if you changed the synthesis parameters. To save a preset PROGRAM, check "Save As". You can fill in the name of the project and the name of the patch to define the search criteria. You can also click cancel to exit this menu without saving.

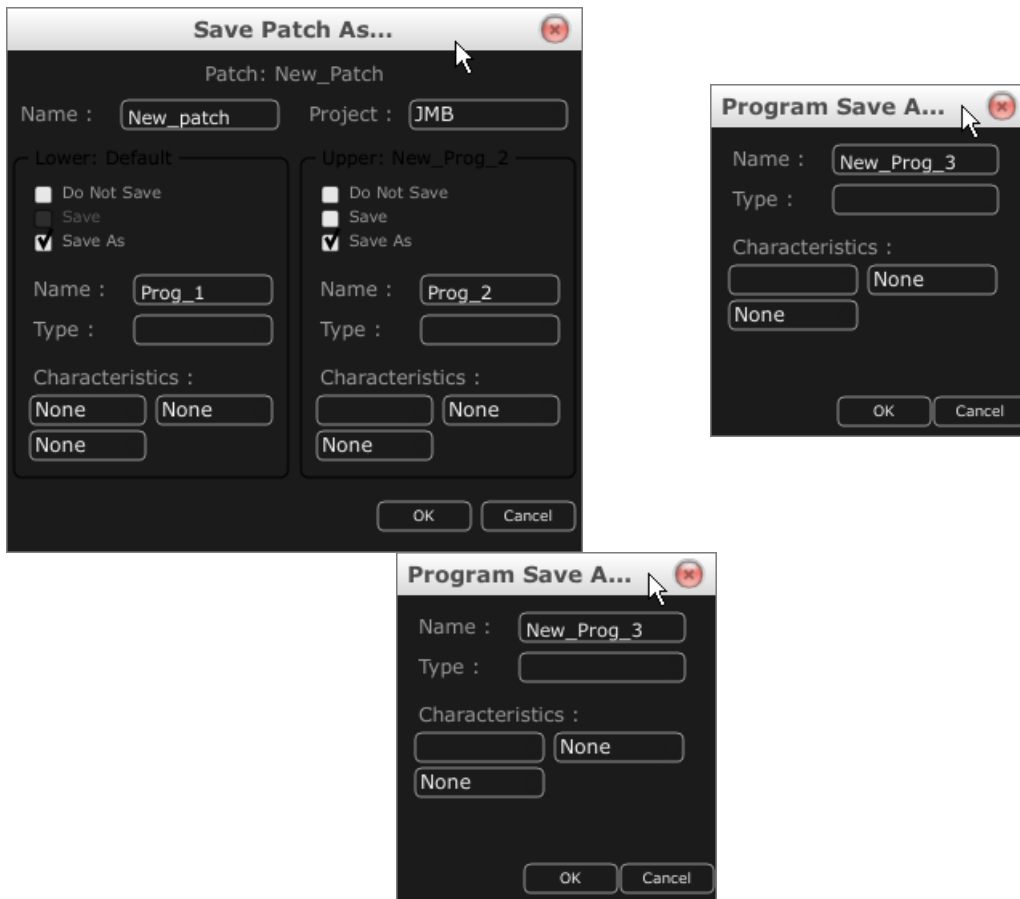

“Save As” and the save menu

 When you work from a factory preset, it cannot be overwritten. Clicking on the “Save” button will not replace the factory preset, but will automatically open the “Save As” dialog to save it as a user preset.

5.2.5 Delete a preset

To delete a selected PATCH or PROGRAM, click on the “Erase” button . A dialog window will appear. Click on “OK” to delete the preset.

5.2.6 Import / Export a preset bank

It is possible to import new banks of presets for the Jupiter-8V.

To import a new “project” bank, click on the import button situated on the right of the interface of the Jupiter-8:

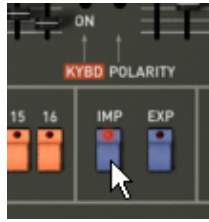

Preset "Import" button

When this button is selected, a window appears, allowing the choice of a preset bank for the Jupiter-8V. Choose a file to import, (it will be shown as a "xxx.j8e" file) and click on "Open". The new bank of presets will appear automatically among the available "Project" banks.

The Jupiter-8V offers the possibility to export user created sounds in order to use them on other machines, or to share them with other users. It is possible to export a preset, a sub-bank, or a complete bank. To export the "project", click on the export button for the preset-bank on the tool bar.

Then select the type of export that you want to carry out (bank, sub-bank or preset), in the list. A window appears, allowing the choice of a destination folder and a file name for the bank to export:

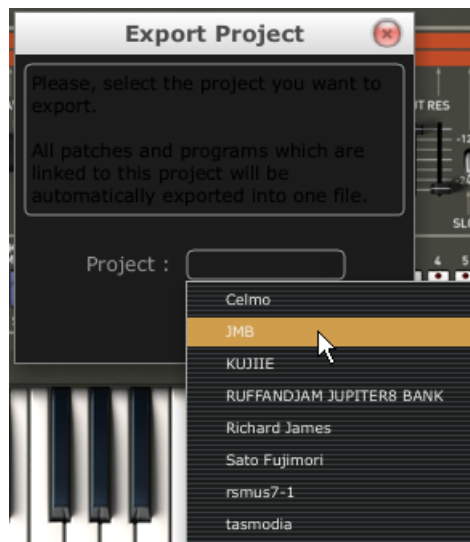

Export a preset "project" bank

5.3 USING THE CONTROLLERS

5.3.1 Knobs

Generally DAWs offer several knob control modes.

The default control mode for knobs with the mouse is the circular mode: click on the knob and turn around it in order to change the value of the controller. The circular mode gives high precision in the manipulation of controls: The further the mouse goes from the knob, the higher the precision of the setting.

In linear mode, the knob can be set only by vertically moving the mouse, not by going around it. Like the sliders, it is possible to obtain a higher precision by right clicking or [Alt]+click on the knob concerned.

The linear mode can sometimes be simpler to use than the circular mode, although we can lose in precision (the precision is limited by the number of vertical pixels on the screen on which the mouse movements are being evaluated). Movement to linear mode is available in the options of your DAW. In Cubase™, for example, this choice can be found via the "File/Preferences/Edit/Controls" menu, and is found in the "General" tab of the window.

5.3.1.1 Potentiometers

As this name indicates, this type of control can be rotated. They can set a continuous value (frequency of the VCO, balance programs for Lower and Upper keyboard for example) or a set a parameter for an individual selection (choices of the wave forms of the oscillators or LFO, for example)



A rotary knob

5.3.1.2 Sliders

These controls are vertical and linear. They set a continuous setting (cutoff frequency of the VCF filters, or settings of the two ADSR envelopes, for example)



A vertical slider

5.3.2 Buttons

There are several types of buttons on the Jupiter-8V. Some activate or deactivate a parameter (activation of the arpeggiator, for example). A red led on the button indicates that the parameter is active.



A selection button

5.3.3 Switches

There are several types of switches on the Jupiter-8V. Certain ones activate/deactivate a parameter. For example, one is used to turn "ON" or "OFF" modulation towards oscillator synchronization. To change its state, simply click the switch.



A switch

5.3.4 Pitch Bend wheel

The Pitch bend controls the frequency/pitch of the synthesizer oscillators. Simply click on the wheel while playing a note on the master keyboard or from a sequencer, then move the mouse horizontally to modify the pitch. The wheel comes back to its initial position at the release of the mouse.



The Pitch Bend Wheel

5.3.5 Modulation button

- ▶ The modulation button applies the modulation created by the LFO, according to the modulation rate set by the LFO. The manipulation of this button is very simple:
- ▶ Click on it to apply the modulation then click again to stop it.
- ▶ To adjust the rate of modulation, set the linear potentiometer called "LFO mod" situated on the left side of the pitch bend. Using this you can control the rate of modulation towards the oscillators' pitches (VCO) to obtain an effect of vibrato, or towards the filter (VCF) to obtain a "wah wah" effect.

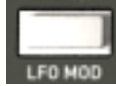

The modulation button

5.3.6 Virtual keyboard

The keyboard lets you listen to the synthesizer sounds without the need for an external master MIDI keyboard, and without programming a melody in the sequencer. Just click on a virtual key to hear the corresponding sound. There is no MIDI output for the keyboard.

5.3.7 LCD Screen

The LCD screen on the extension panel of the Jupiter-8 allows selection of presets, editing of the sequencer, as well as the Galaxy interface, the keyboard settings and the effects.

- ▶ To open the extension panel, click on the "Open" button situated on the tool bar.
- ▶ To choose which function to edit, click on one of the buttons situated on left top corner of the screen. (« PRESET « for example). The « SEQUENCER/GALAXY/KEYBOARD « screen has two tabs that let you edit the sequencer and the galaxy module.
- ▶

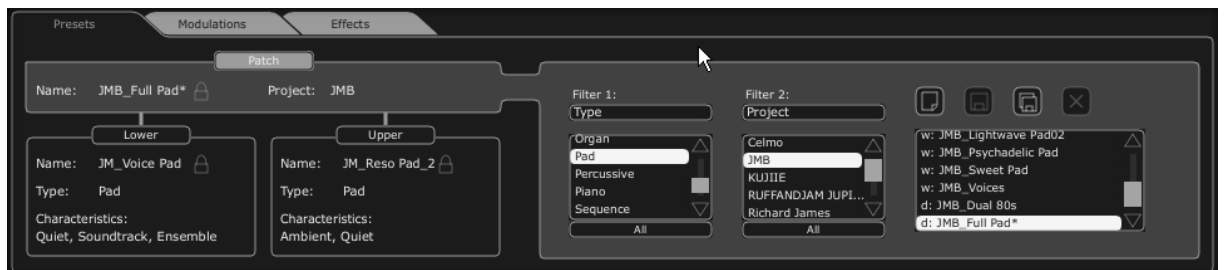

5.3.8

5.3.8 LCD screen

5.3.9

5.3.10 MIDI Control

Most of the knobs, sliders and switches on the Jupiter-8V can be manipulated with external MIDI controllers. Before anything else, make sure that the MIDI device is correctly connected to the computer, and that the sequencer or the standalone Jupiter-8V application is correctly configured to receive MIDI events coming from the device.

- Learn assignment

The fastest and easiest way to assign a control is to move the fader, knob or button for it to be recognized by Jupiter-8V.

- Manual assignment

It is also possible to change the assigned MIDI control number by clicking on Control#xx and select a specific value.

- Support for NRPN

In addition to MIDI Control Change messages, NRPN messages are now supported: either send NRPN MIDI control messages to Jupiter-8V, or check NRPN, then manually select LSB# and MSB# numbers:

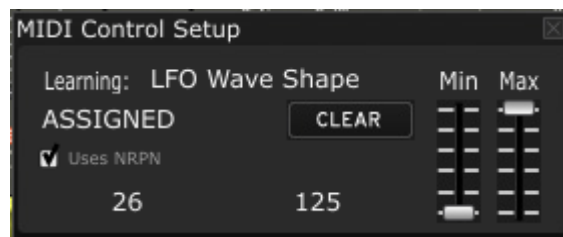

MIDI assignment popup, NRPN activated

- Remove assignment

Assignments can be removed by clicking the "Clear" button. The message "Unassigned" will then be displayed.

Continue selecting the parameters you want to map to create a complete configuration.

5.3.10.3 Manage Configurations

New in Jupiter-8V: the possibility to maintain multiple configurations.

- Default configuration

By default, Jupiter-8V loads the configuration for Arturia Analog Experience keyboards.

- Select one configuration

A configuration is loaded by clicking the corresponding entry in bottom part of "Learn menu".

- Create a new configuration

A new configuration can be created by clicking on the "Learn menu", "New Config" entry. This will open a popup: enter the name you want to call your configuration and click on the "SAVE" button. A new entry for your configuration now exists in the list of available configurations.

You may now fill in this initially empty configuration by performing the assignment operations described in the previous section.

- Copy a configuration

It is possible to copy a configuration by loading it and then clicking on "Save Config As".

A popup opens: enter the name of your configuration. A new entry for your configuration now exists in the list of available configurations.

- Remove a configuration

It is possible to remove a configuration by first loading it and then clicking on "Delete Current Config".

5.3.10.4 Minimum and Maximum Ranges

For each assignment, a minimum range value and a maximum range value can be set. This allows you to limit how much the controller will affect the parameter on Jupiter-8V.

- The assigned parameter will have the configured minimum value when the controller will be at its lowest position
- The assigned parameter will only reach the configured maximum value when the controller will be at its highest position
- You can invert (Negative Slope) the Min and Max so that parameter will have minimum value when control has the highest value, and parameter will have maximum value when control has the lowest value

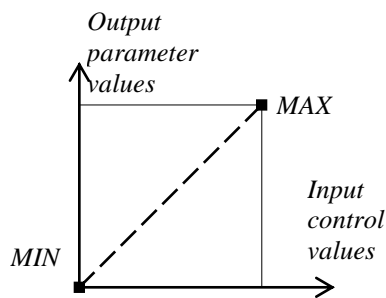

DEFAULT

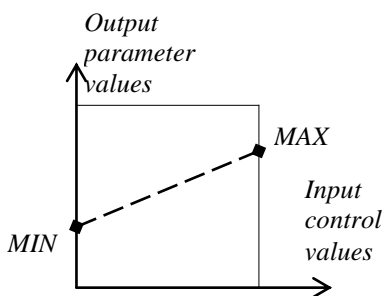

POSITIVE SLOPE

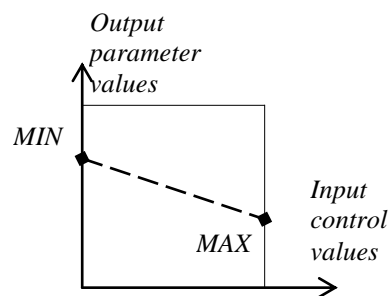

NEGATIVE SLOPE

$$\text{parameter_value} = \text{MIN} + (\text{MAX} - \text{MIN}) * \text{control_value}$$

5.3.10.5 Multiple Assigned Parameters

It is possible to assign multiple parameters to a single control. This allows you to change many parameters with one fader or knob.

- Activate “Learn” mode, select a parameter (GUI control)
- Tweak control to assign it (optionally setup minimum and maximum)
- Select a second parameter
- And tweak the same control
- Deactivate “Learn” mode

Tweaking assigned control should modify both parameters with regards to assignation setup (Min, Max).

5.3.11 The preference screen

On this screen, you are able to:

- See the version of the software
- Read the credits
- Activate or deactivate the pop-up windows animations

To open this window, click on the “About” button situated on the bottom right of the Jupiter-8V interface.

5.4 THE SOUND MAP

The sound map is an innovative preset explorer which offers an easy and revolutionary way to locate and choose a preset on a map area, thus simplifying preset management and making it much quicker to find an appropriate sound.

The sound map also offers a brand new interface for creating new sounds thanks to morphing feature works between four presets.

The Sound Map offers three views:

- The MAP main interface: the sound map classifies the presets thanks to statistical methods in order to organize the sounds on a map from their own audio characteristics.
- The LIST presets list: this page offers a more classical interface to classify the presets using lists and filters to find the desired sound.
- The COMPASS morphing interface: this page allows creating new sounds in real time thanks to a morphing result with up to 4 presets.

Let’s have a deeper look in the Sound Map different views:

- ▶ To open the main Sound Map interface, click on the SOUND MAP button  located in the toolbar.
-
- To open the preset list page, click on the LIST button, on the top right of the sound map interface.



Open the List interface

- To open the preset morphing page, click on the COMPASS button.



Open the Morphing interface

- To return back to the main sound map interface, click on the MAP button



Return back on the map interface





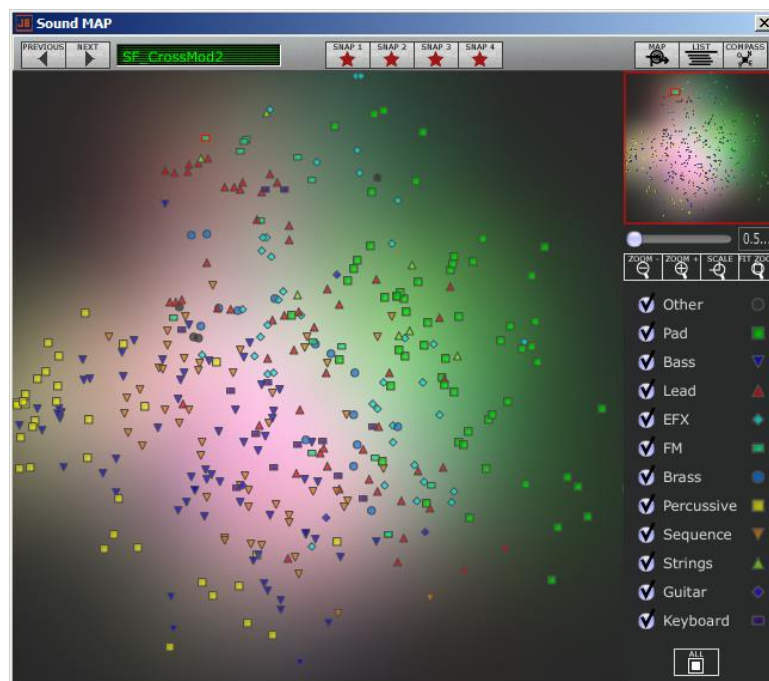







5.4.1 The MAP main interface

The Sound Map main interface shows a map where all the presets of the Jupiter-8V are spread out, organized by their different types of sound and their own audio characteristics.



The Map interface

The types of presets are represented by different geometrical symbols and colors for an easy way to locate them:

-  "Bass" sounds
-  "Brass" sounds
-  "EFX" sounds
-  "FM" sounds
-  "Guitar" sounds
-  "Keyboard" sounds
-  "Lead" sounds
-  "Pad" sounds
-  "Percussive" sounds
-  "Sequence" sounds
-  "Strings" sounds
-  "Others" sounds

- To select and to listen a preset, directly click on one of the icons, anywhere you want on the map area. The icon is now highlighted in red. If you hold a few seconds on the selected preset, a popup appears and indicates the name of the preset.

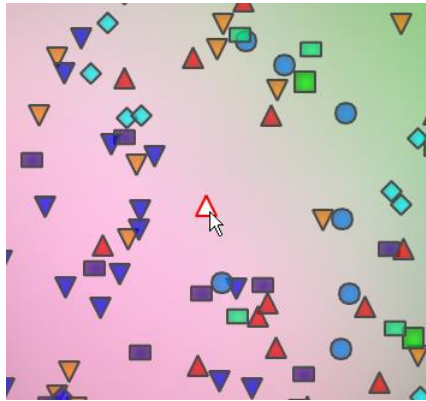

Select a preset

You can create new presets thanks to an exclusive real time morphing feature:

- Click between several presets and drag the mouse. Four red arrows drawing a cross appear linking the group of four presets. The sound of the Jupiter-8V will be modified with regards to the distance between the mouse pointer and the selected presets. Get closer to a preset to make the synth sound like this preset does.

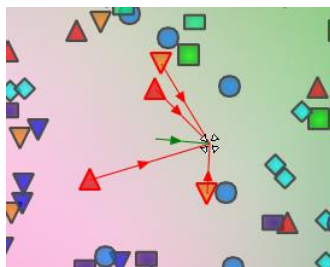

Morphing between a group of presets

- You can now drag your mouse between those presets. The green arrow shows you the starting point of your motion.
- When you release the left mouse button, you can play the resulted sound and, if you wish, you can save it on a Jupiter-8V user bank.

In this way it is very easy to quickly get some new and exciting sounds without programming anything on the synthesizer interface.

5.4.2 The Sound Map overview

On the top right of the Sound Map main interface, you can see an overview of this map.

You can use the map overview for navigating into the map and to zoom in or out inside of the map area.

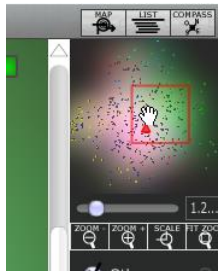

The map overview interface

- To navigate into the map, click inside of the red square and drag it on the map area to view other sections of the Sound map.
- To zoom in the view on the sound map, click on the Zoom slider, under the overview window, and drag it towards the right to increase the size of the map.
- To zoom out the view on the sound map, click on the Zoom slider, and drag it towards the left to decrease the size of the map.



The zoom slider

 You can also use the "ZOOM +" or "ZOOM -" buttons, under the slider, to increase or decrease the map size step by step (by a factor of 1).

- Clicking on the FIT ZOOM button  allows resizing the map to its global size.

5.4.2.1 The instrument type filter window

On the right of the map main interface, an instrument type filter window allows you to choose which type of preset you want to see (or to hide) on the map. By default, all types of presets are selected.

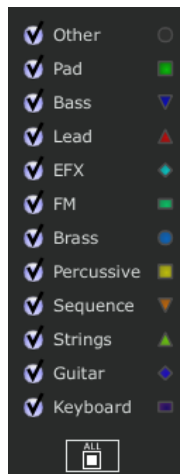

The instrument type filter

To select an individual or a group of instrument types:

- First click on the All button  , on the bottom of the type filter window: this will hide all the instrument types from the sound map.
- Then, select the type(s) you want to see by clicking on the corresponding square box(es). A check appears on the selected box(es) and the type(s) of preset appears on the map interface.

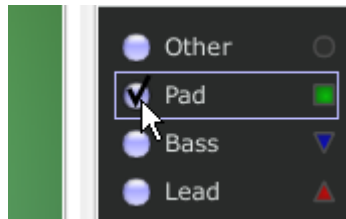

Show pad presets

This is a good way to simplify and refine the preset search.

- If you click again on the All button, all types of presets will be displayed on the map.

5.4.2.2 Preset snapshot memories

You can select up to four presets, anywhere on the map interface, and save them on up to four snapshot memories. You will be able to use those four presets on the COMPASS view to create new sounds by morphing feature (see below for more details on this feature).

Of course, you can save any kind of preset on these four snapshot memories.



Select a snapshot memory

To save a preset on a snapshot memory:

- Select a preset on the sound map main interface.
- Hold the [Shift] key and select one of the four snapshot memory buttons. The snapshot memory button is now highlighted in red.
- Repeat the same actions if you wish to save presets on the three other snapshot memories.
- When all memories already contain a saved preset, you can replace them with other presets.
- Select another preset anywhere on the Sound Map interface, click on any of the 4 snapshot buttons while pressing the [Shift] key.

5.4.3 The LIST preset manager

The list preset manager offers a more traditional way to explore presets using a list interface in which the presets are classified and filtered in order to simplify preset management.

- To open the list interface, click on the LIST button located on the toolbar of the Sound Map.



Click on the LIST button

The list preset interface is very simple; you can see four columns showing, from left to right:

- ▶ The preset names
- ▶ The instrument type
- ▶ The name of the sound designers
- ▶ A reminder of the presets added to a snapshot memory

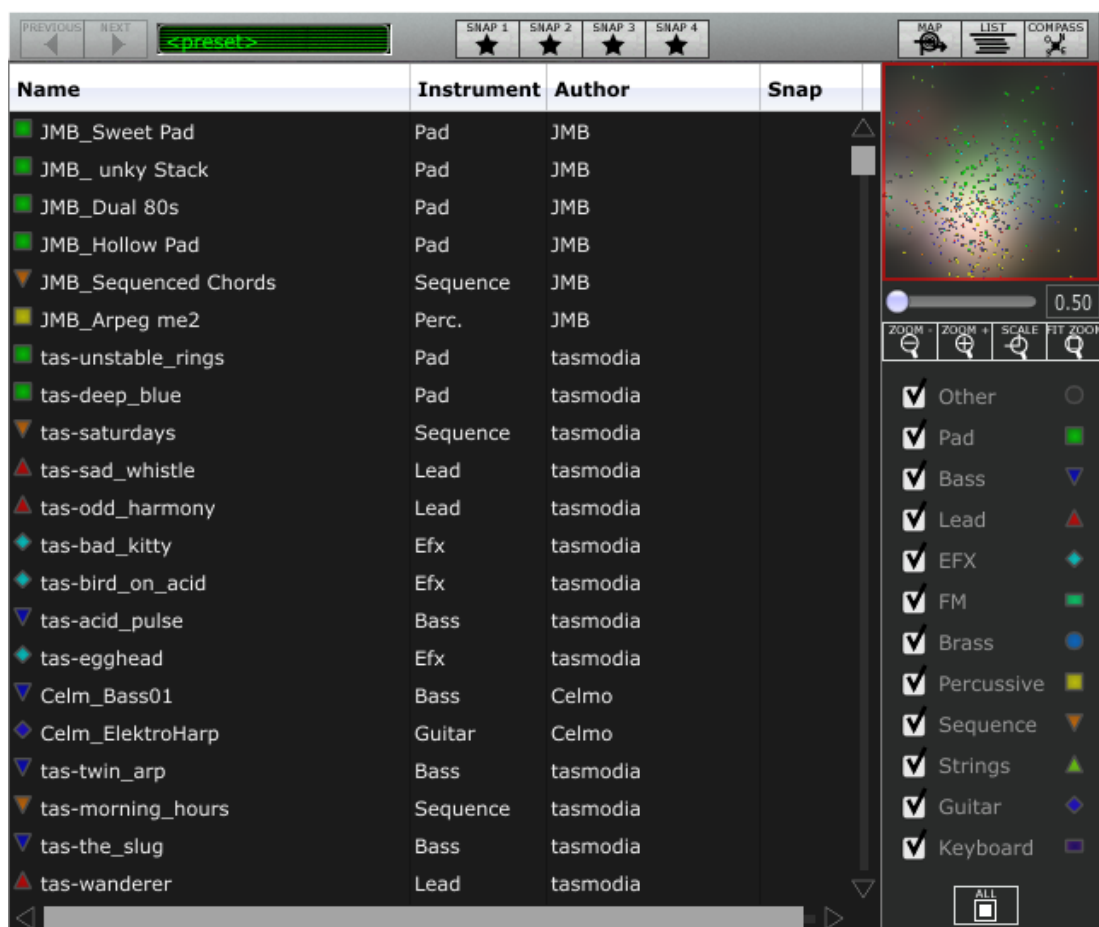

Preset list interface

All this data is classified by alphabetical order.

- To select a preset, simply browse the list and click on the name of a desired preset.
- You can reverse the order (from A to Z or from Z to A) by clicking on the column title: an ascendant or descendant arrow shows you the order type.

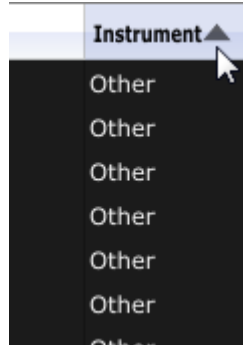

Inverse the order of the instrument types

5.4.4 The COMPASS morphing interface

The Morphing page is an independent module allowing you to quickly create some new sounds thanks to a real time morphing feature between the four selected presets saved on the snapshot memories.

The four presets are placed on the four cardinal points of the compass.

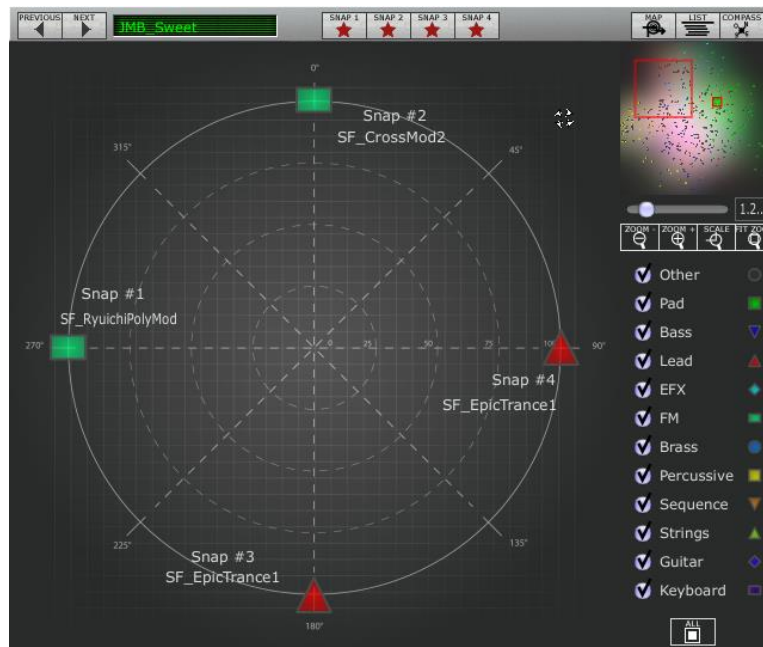

The Morphing interface

- To open the Morphing page, click on the COMPASS button, located on the toolbar of the Sound map.

To create a new morphed sound from these presets:

- Click anywhere on the centre of the compass area (four red arrows appear converging to the location).
- Hold the left button of your mouse and drag the convergence point until you have found the right sound. The green arrow shows you the starting point of your motion.

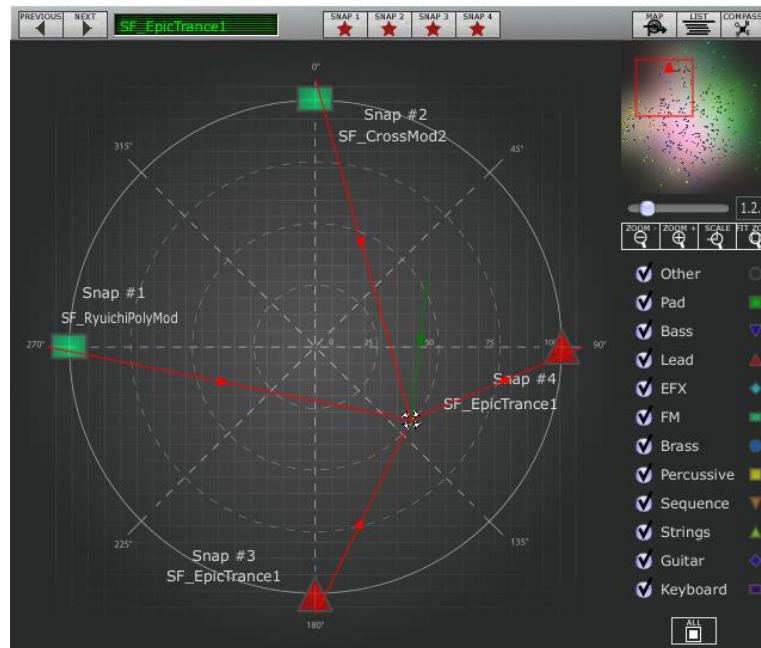

Create a new sound

- If you wish, you can save it on a User bank of the Jupiter-8V memory.

6 THE DIFFERENT MODULES

The interface of the Jupiter-8V consists of four main parts:

- The interface of the original Jupiter-8V
- The "PRESET MANAGER" offers a dedicated interface to manage the presets
- The "EXPANDED PARAMETERS" part offers a selection of real-time controllers ("GALAXY" "SEQUENCER" and "KEYBOARD"), as well as access to the modulation options available for the synthesis and effects parts of the Jupiter-8V
- The effect section ("EFFECTS")

These four parts are accessible by clicking on the tabs situated above the synthesis part of the interface.

6.1 THE ORIGINAL JUPITER-8

The "Jupiter-8V" interface takes on all the original parameters and characteristics of the synthesizer it is based on. Likewise, the 40 factory presets of the original machine are included (these can not be deleted).



The Jupiter-8V

The Jupiter-8V consists of:

- 2 oscillators (« VCO 1 and 2 ») in which the second can equally be used as a source of modulation
- 1 mixer for the volume of the 2 oscillators.
- 1 High pass filter (« HPF ») 6dB/oct non-resonant
- 1 low pass resonant filter (« VCF ») 12/24dB/oct
- 1 amplifier
- 2 envelopes dedicated to filter and amplitude modulations

- 1 LFO (low frequency oscillator)
- 1 modulation section (WHEEL MOD) dedicated to the LFO

6.1.1 The oscillators ("VCO 1 and 2")

There are two oscillators.

The oscillator controls the basic frequencies and timbres of the Jupiter-8V with the frequency settings, choice of waveform, and the pulse width associated to the square waveform. These settings are made either with various knobs (static settings) or by the means of the modulation sections. These can be activated in the "LFO-MODULATION" section (monophonic modulation by the LFO) or the "CROSS MOD" (polyphonic modulation using the frequency of oscillator 2 on oscillator 1).

The oscillators can be tuned and edited separately. They allow selecting one of four waveforms on each oscillator. The two oscillators have some different waveforms. (E.g. OSC1: triangle, square / OSC2: white noise, Sine) These waveforms can be used simultaneously. Whether tuned separately or when using several mixed waveforms, the two oscillators allow you to quickly obtain a rich variety of sounds.



Two Oscillators

6.1.1.1 VCO 1

6.1.1.2

RANGE Switch the frequency range for VCO 1 («RANGE»), between one of four octaves 16', 8', 4', 2'. (The unities are indicated in feet, referring to the sizes of the pipes of church organs)

WAVE Switch for the four waveforms:

- Triangle
- Saw Tooth
- Variable Pulse
- Square

CROSS MOD Knob to set the frequency rate of modulation between the frequencies of VCO 2 towards the frequencies of VCO 1

•

6.1.1.3 VCO 2

6.1.1.4

RANGE Switch the frequency range for VCO 2 («RANGE»), choose between four octaves 16', 8', 4', 2'

LOW FREQ Switch for the «FREQ /NORMAL» (low frequencies / audible frequencies), of VCO 2, of which the oscillation frequency is lower, and enables you to use it as an LFO to modulate the frequency of the VCO1.

FINE TUNE Knob to fine tune pitch with the range of plus or minus one half tone.

SHAPE • Switch for the four waveforms:

- Sine
- Saw Tooth
- Variable Pulse
- White noise

 *The white noise waveform brings an interesting complement to the sonic possibilities. It is very useful to create breath effects (flute tones for example) or special effects like the sound of wind for example.*

SYNC The synchronization between oscillators allows you to create very complex waveforms and overtones. When oscillator 2 is synchronized with oscillator 1, oscillator 2 will restart a new period every time the first oscillator completes its period, even if oscillator2 has not fully completed its current cycle (this signifies that it is not tuned to the same tonality!)

•

Here are some of the representations of the different waveforms used by the oscillators of the Jupiter-8V:

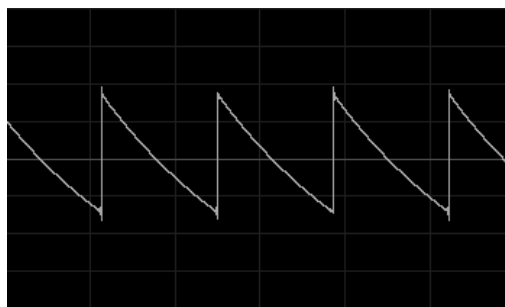

Saw tooth

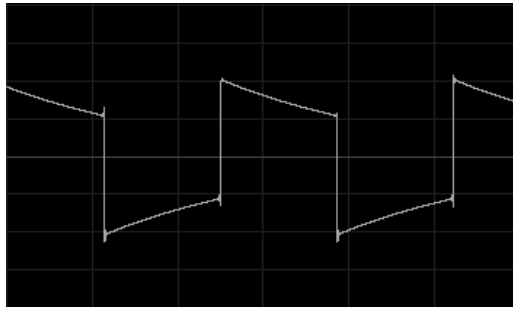

Square

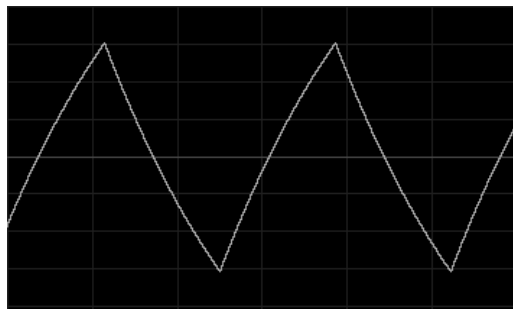

Triangle

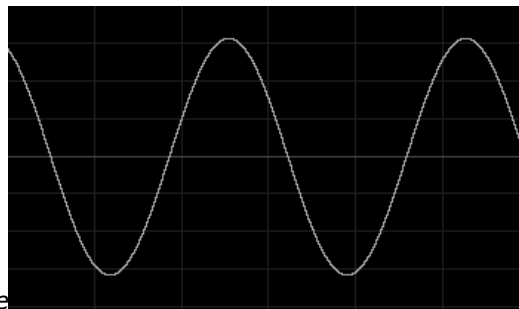

Sine

6.1.2 The mixer ("VCO1 / VCO2")

The mixer allows regulating the volume of the mix between oscillators 1 and 2.

- VCO 1** Knob to set the volume for Oscillator1 (LEFT)
- VCO 2** Knob to set the volume for oscillator 2 (RIGHT)
- VCO 1/2** Knob to set the volume for both oscillators (CENTERED)



The mixer

6.1.3 The filter ("VCF")

The Jupiter-8V has a filter that is an emulation of the original Jupiter 8 filter. It is made up of two independent filter units:

6.1.3.1 A non-resonant 6 dB/octave high-pass filter

The high-pass filter eliminates the frequencies while letting high frequencies go through. The sound will become thinner. It is very useful to remove bass frequencies of a pad sound for example.

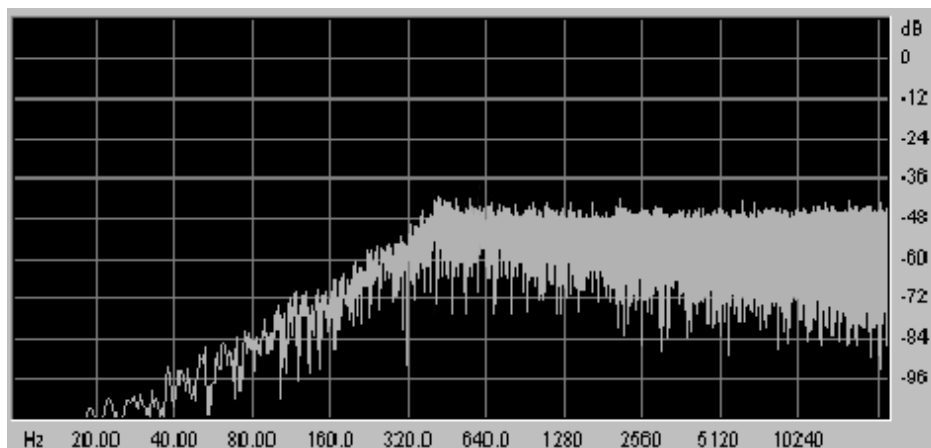

The non-resonant high pass filter

CUTOFF FREQ Knob to set of the cut off frequency of the filter



Non-resonant high-pass filter

6.1.3.2 A resonant 12 or 24 dB/Octave low-pass filter

The low-pass filter is characteristic of the Jupiter-8V's sound. It eliminates the frequencies situated above the frequency setting (the cut off frequency).

The resonance amplifies the frequencies near the cutoff frequency. Turn this knob toward the right, and the filter will become more selective. At extreme settings, the sound will eventually begin to "whistle" as the filter begins to self-oscillate.

Note that the filtering will be less strong with the filter type set on 12 dB instead of 24 dB.

 For hosts that allow "linear" control of knobs and sliders, right-click the mouse or [Command]+lick on Mac for additional precision. This is useful when trying to regulate the level of the cut off frequency precisely, for example. When in "circular" control mode, simply click on the knob and drag the mouse pointer out into a broader arc for a more precise setting.

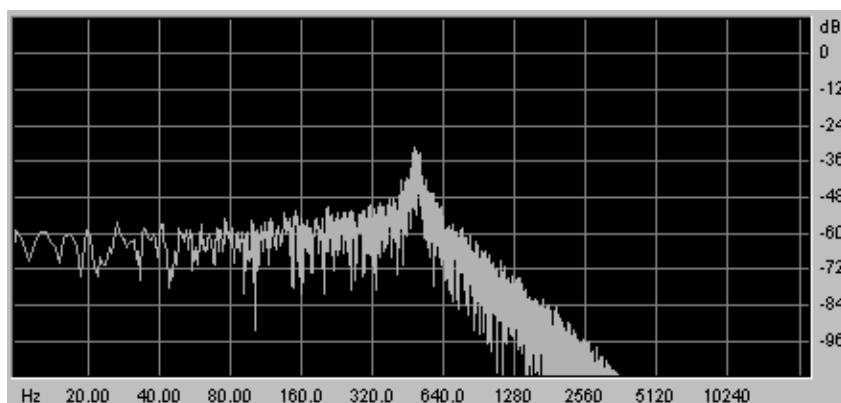

Resonant low-pass filter

CUTOFF FREQ Knob to set of the cut off frequency of the filter, From 10 Hz to 25 KHz.

RES Knob to set the resonance of the filter.

SLOPE Switch the filtering slope 12 or 24 dB/ octave.

ENV. AMT Knob to manually set the rate of filter modulation by the ADSR envelope.

ENV1 / ENV 2 Switch to choose whether the modulation source for the cutoff is envelope 1 or envelope 2.

LFO MOD Knob to set the level of modulation by the LFO (use this parameter to make a wah-wah effect).

KEY FOLLOW Knob to manually set the keyboard follow.

 For a conventional setting of the keyboard follow, place the knob in the middle (value 1.00).

The cutoff frequency of the filter can be modulated by one of the two ADSR envelopes (see the following chapter). It can also be modulated by the LFO.



The VCF

6.1.4 The Amplifier (“VCA”)

The amplifier is the last step in controlling the sound. It allows setting the general volume of the Jupiter-8V.



The amplifier (VCA)

This module is very simple, it consists of:

VOLUME Knob to set the volume of the synthesizer

LFO MOD Slider to set the intensity level of the modulation by the LFO.

The amplifier’s volume is directly affected by envelope 2 (ADSR2).

6.1.5 The ADSR Envelopes

The «ADSR» envelopes allow several parameters to be controlled with the help of the keyboard as a trigger. You will find two envelopes on the Jupiter-8: one unit for the cutoff frequency of the filter (as well as the frequency of VCO2) and another one to modulate the VCA amplitude.

When playing the keyboard, the envelopes will trigger and modify the way to sound will be heard.

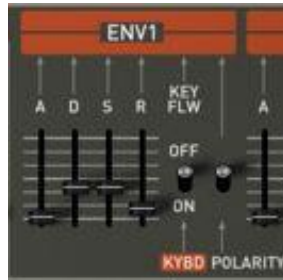

The ADSR envelope of the filter

The ADSR envelope consists of 4 different parameters:

- ATTACK** The **Attack** is the **time** that the sound will take to reach its maximum volume once we have pressed a key on the keyboard.
- DECAY** The **Decay** is the **time** that the sound will take to diminish after the attack portion is complete.
- SUSTAIN** The **Sustain** is the maximum volume **level** that the sound will reach after the decay is complete.
- RELEASE** The **Release** is the **time** that the sound will take to diminish once the key has been released.
- KEYFLW** Switch to connect envelope 1 and/or 2 to the keyboard follow. When the switch is "ON", the envelope times – "A", "D" and "R" – will be as shorter as you will play the higher notes on your MIDI keyboard.
- POLARITY** Switch to set the polarity for envelope1:
 - If the switch is on the top, the envelope polarity is positive (this is the more common way to use an envelope).
 - If the switch is on the bottom, the polarity is negative. The envelope's time settings are reversed: the shorter times will be heard when the faders are on their higher positions. This type of polarity is very nice to create some inverted effects. Take a look on the preset "Original JP-8 Preset / EFX / JP-8_66_Fact" to hear an example of this special effect.

6.1.6 The LFO

Using the LFO as a modulation source is very common. It can be used to create a vibrato effect (when the LFO modulates the frequency of an oscillator) or a "wah-wah" effect (when it modulates the cutoff frequency of the filter).

- RATE** Knob to set the speed of the LFO
- DELAY TIME** Knob to set the delay time before the LFO becomes active
- WAVEFORM** Switch the LFO's waveform:
 - Sine
 - Saw tooth
 - Square

- Random



The LFO

6.1.7 The VCO modulator

The VCO modulator section allows adding modulations to both of the oscillators' frequencies (for vibrato or automatic pitch bending effects) and on the pulse width of their waveforms.

Frequency modulation

- LFO** Slider to set the level of modulation from LFO on the VCO frequencies.
- ENV1** Slider to set the level of modulation from Envelope 1 on the VCO frequencies.
- VCO 1** Selector to choose either oscillator 1, oscillator 2 or both oscillators as destinations for LFO / ENV modulation.
- VCO 2** Selector to choose either oscillator 1, oscillator 2 or both oscillators as destinations for LFO / ENV modulation.
- PWM** Slider to set the level of modulation on the VCOs' pulse width.
- LFO** Selector to choose either a manual setting (via the fader), LFO or envelope 1 as a source for the pulse width modulation.
- M**
- ENV1**

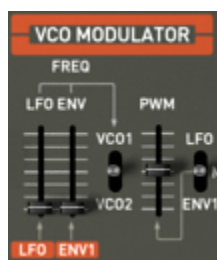

The VCO modulator section

6.1.8 The LFO MODULATION, PORTAMENTO and BEND section

The "LFO MOD" section shows the parameters that can be modulated by the LFO. There is a white button to activate the LFO. When it is pressed, the modulation is activated. When it is raised, the modulation stops.

LFO MOD RISE Knob to set the triggering time of the LFO.

LFO MOD Chooses the destinations that can be modulated by the LFO:

- ON / OFF switch (« VCO »)
- ON / OFF switch (« VCF »)

VCO level Slider to set the level of modulation from the LFO to the VCO

VCF level Slider to set the level of modulation from LFO to the VCF

BEND Selectors of the destinations that can be modulated by the PITCH BEND

- ON / OFF switch (« VCO 1»)
- ON / OFF switch (« VCO 2»)
- ON / OFF switch (« VCF »)

VCO level Slider to set the intensity of the BEND modulation affecting the VCO (From 0 To +24 semi-tones / - 24 semi-tones).

VCF level Slider to set the intensity level of the BEND modulation affecting the VCF.

BENDER Pitch bender (movement towards the left: the tuning is diminished; movement towards the right, the tuning of the oscillators is increased)

PORTAMENTO level Slider to set the level of portamento.

PORTAMENTO select Switch to use the portamento:

- Connection Section UPPER (« UPPER ONLY»)
- Connection PORTAMENTO OFF
- Connection Sections LOWER et UPPER (« ON »)

•



Destination connections

6.1.9 The pitch bend wheel and LFO MOD button

The pitch bend wheel and the push button for the amount of modulation by the LFO (« MOD ») are situated to the left side of the virtual keyboard.

PITCH This wheel controls the pitch bend of the two oscillators

LFO MO Push Button to control LFO modulation



The Pitch Bend wheel and the LFO mod button

6.1.10 The Master Tune section

Among these parameters you will find: the general tuning of the Jupiter-8V, the detune option for the voices and a 440 Hz tone to tune the Jupiter-8V.

TUNE Knob to set the general tuning of the synthesizer (+/- one semitone).

DETUNE Set the amount of detune of the polyphonic voices.

 The detune knob of the polyphonic voices is very useful to make out-of-tune sounds in the "unison" mode. It will sound a little like the effect of a chorus. When the «Unison» is not active, this parameter brings a little more instability to the tuning of the oscillators, a typical characteristic of the original machine.



The Master Tune parameters

6.1.11 The arpeggiator ("ARPEGGIO")

This section shows the connections that are necessary to make the arpeggiator work. It allows performance of patterns of notes in a particular order, evolving according to the notes played.

- In SPLIT mode, the arpeggiator only works with the lower part of the keyboard.
- In DUAL MODE, the arpeggiator works on both parts of the keyboard.

The pattern development is possible to control with two parameters:

RANGE Choose the range of the arpeggiator 1-4(in octaves):

- One octave (button ON/OFF "1")
- Two octaves (button ON/OFF "2")
- Three octaves (button ON/OFF "3")
- Four octaves (button ON/OFF "4")

MODE Choose the playing mode:

- UP (button ON/OFF)
- Down (button ON/OFF)
- Up and Down (button ON/OFF)

- Random (button ON/OFF)

The rate of the arpeggiator can be set on the left side of the LFO section (next to the general volume and LOWER / UPPER balance potentiometers).

In the same area, you can also affect the MIDI synchronization for the arpeggiator rate ("EXT" position).



The arpeggiator section



The arpeggiator rate section

6.1.12 The keyboard assign section ("ASSIGN MODE")

This section allows selecting the play modes as follow:

- SOLO** Button for selecting the monophonic mode.
- UNISON** Button for selecting the Unison mode. When "**UNISON**" is activated, all the voices are regrouped to be played by one note of the keyboard. The result is a rich harmonic sound. It sounds similar to a chorus effect. When the Unison mode is activated the patch is still polyphonic (the amount of polyphony depends on the number of voices available)
- POLY 1** The most natural polyphonic playing mode. The envelopes are not reinitialized by each note played.
- POLY 2** Polyphonic playing mode reinitializing the envelopes with each note played. The « release » time is cut by the next note played.
- HOLD LOW** This mode allows holding the played notes on the LOWER part. (This effect is similar to a sustain pedal action).
- HOLD UP** This mode allows holding the played notes on the UPPER part.

In SPLIT mode, the HOLD function can be assigned to both the LOWER and UPPER parts independently. In DUAL and WHOLE modes, the HOLD function simultaneously affects both parts. ⚠️ Only the volume envelope

will be used by the hold function. That allows you to bring life to the sound while keeping the envelope free for the filter.

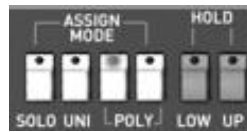

6.1.13 Play mode section The play modes selection ("KEY MODE")

The methods of playing indicate the distribution of the programs on the keyboard. They are 3 selectable configurations that can be set to: "ON/OFF":

- DUAL** Two selected programs on the LOWER and UPPER part can be played simultaneously on the keyboard. The polyphony is then divided by two.
- SPLIT** Two selected programs are assigned the LOWER and UPPER part of the keyboard. The polyphony is then divided between the two selected programs.
- WHOLE** A single program is assigned to the entire keyboard range.



Key modes

6.2 STEP SEQUENCER

The sequencer is a 32-step sequencer.

It allows the creation of several melodic lines (when one of the three available modulations is affecting the pitch of the VCO) as well as creation of dynamic modulations of other parameters such as the cutoff frequency of the VCF or the width of the VCO square waveform.

Click on the "Modulations" tab, then, click on the "Sequencer" button to bring up the interface.

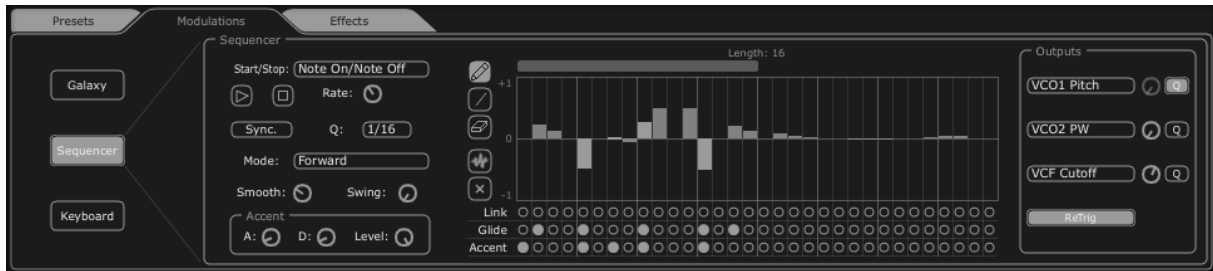

The step sequencer

The interface of the sequencer consists of three main parts:

6.2.1 The transport

The transport is on the left side of the sequencer. It consists of the necessary parameters to play and stop the sequence, MIDI synchronization, quantification and trigger ("trigg") parameters:

- START STOP** Selection screen to control the sequencer's playing mode:
- Note On/ Note OFF: Start / Stop with a note ON / OFF message.
 - MIDI Start / Stop : Start / Stop the sequencer with a MIDI sequencer (or a drum machine for instance)
 - Free running: Start / Stop the sequencer with the Start/Stop buttons of the step sequencer.

START STOP buttons Start / Stop the sequencer, in "free running" mode only

RATE Set the speed of the sequencer, in "free running" mode only

SYNC ON/OFF Synchronization to an external MIDI clock

Q Subdivision of MIDI tempo to adjust the speed of the sequencer in "MIDI Sync" mode:

1/2 ; 1/4 ; 1/4T ; 1/8 ; 1/8T ; 1/16 ; 1/16T ; 1/32 ; 1/32T ; 1/64 ; 1/128

Mode Playing modes of the sequencer:

- FORWARD: Playing the sequence forward
- BACKWARD: Playing the sequence backward
- FORWD/ BACKWD: Playing the sequence forward and backward
- RANDOM: Playing the sequence randomly

SMOOTH Amount of interpolation between values of each step in a sequence.

SWING Automatically bring a ternary quantification to the sequence. This parameter will be very useful to add "groove" to a sequence for hip hop music, for example.

ACCENT Bring an additional modulation to the selected step thanks to an "Attack" / "Decay" envelope applied to the cutoff frequency of the VCF low pass filter. This unit is comparable to the one that is located on the very famous TB303. The possibility to edit the attack time was added to the original unit to allow more flexibility.

- A: Attack time of the accent envelope
- D: Decay time of the accent envelope
- LEVEL: Knob that controls the modulation amount of the accent to the low pass VCF Filter.

-
-

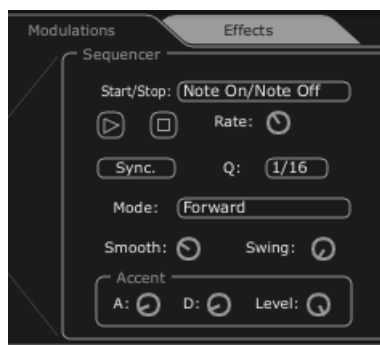

The transport section

6.2.2 Edit the sequence

The editable part of the sequencer is located in the center of the sequencer's interface.

Edit tools Five tools are available for editing the sequence:

- **Pencil:** drawing of the values of the steps
- **Line:** drawing of the values of the steps in line
- **Eraser:** Delete certain values and settings
- **Noise:** Automatically create a sequence
- **Reset:** Reset the sequencer

STEPS The steps. They contain bi-directional values (positive or negative).

LENGTH To set the length of the sequence, 32 steps maximum.

LINK Link the selected step with the following step, « Legato »).

GLIDE Place an effect of portamento between the selected step and the following step.

ACCENT Place an accent effect on the selected step.



6.2.3 The edit section of the sequencerOutputs

The modulation destination ("OUTPUT") is located to right of the interface of the sequencer, where the synthesis parameters that will be affected by the sequencer are selected.

💡 It is also possible to connect the parameters of the voice effects to the sequencer. To do that, go to the "Effects" / "Voice Effects" page. Then choose the source "Sequencer" among the choices of sources of proposed modulations for the parameters of these effects. (see paragraph "Voice Effects" for more details)

Three connection locations are available for the sequencer.

For each of them the following destinations are available:

DESTINATION Choice of available modulation destinations

- **None:** Nothing is connected
- **VCO1 Pitch:** VCO1 FREQUENCY
- **VCO2 Pitch:** VCO2 FREQUENCY
- **VCO1 PW:** Pulse width of the square wave form of VCO1
- **VCO2 PW:** Pulse width of the square wave form of VCO2
- **HPF Cutoff:** Frequency of the high pass filter
- **VCF Cutoff:** Frequency of the low pass filter
- **VCF Res:** Resonance of the low pass filter
- **VCA:** Volume of the VCA

AMOUNT Sets the level of modulation

Q Quantification of the modulation settings by semitones. This parameter is essential to regulate the levels of each step for the creation of a melodic sequence

RETRIG Automatically place a «trig» envelope on all the steps.



The connection section

6.3 GALAXY

The galaxy module creates very complex modulations with the interaction of 3 LFOs.

The first 2 LFOs can each modulate a different parameter on the X/Y axes, represented in the framework of the interface. A third LFO allows modifying the alpha angle between the X and Y axes.

Each of these 3 LFOs have two parameters:

SHAPE Selection screen for the waveform of the LFO and X/Y axis ("Sine", "Tri", "Saw" and "Square") and "Sine", "Tri" and "Saw" for the third LFO.

RATE Knob to set the modulation frequency of the LFO.

ANGLE Knob to set the rotation angle of the X/Y axis manually.

- Three modulation outputs can be connected. For each, the following modulation destinations are available: "None": Nothing is connected
"VCO1 Pitch": VCO1 FREQUENCY
"VCO2 Pitch": VCO2 FREQUENCY
- "VCO1 PW": Pulse width of the square wave form of VCO1
"VCO2 PW": Pulse width of the square wave form of VCO2
"HPF Cutoff": Frequency of the high pass filter
"VCF Cutoff": Frequency of the low pass filter
"VCF Res": Resonance of the low pass filter
"VCA": Volume of the VCA

A reset setting of the movements for the three LFO's by a played note is available by using the "RETRIG" button.

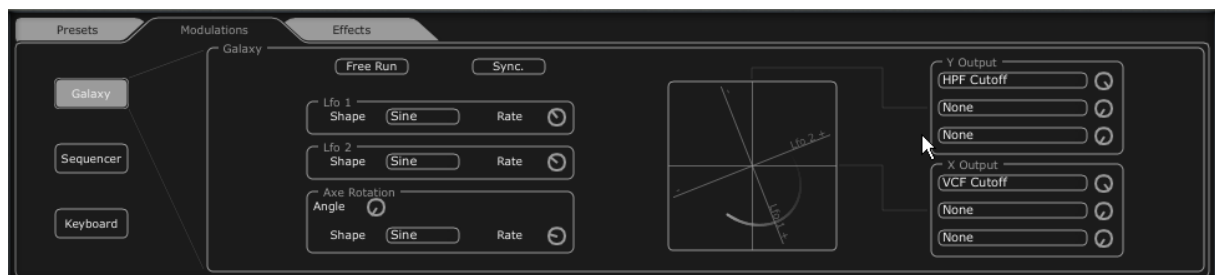

The Galaxy module

6.4 VOICE EFFECTS

The Jupiter-8V offers two connections of "Voice" effects. These connections can be made inside the synthesis chain, between the VCO and the VCF and between the VCF and the VCA.

These effects can be modulated by sources of modulation such as the LFO or the envelopes. These combinations of effects and of modulations will bring an additional dimension to the original sound of the Jupiter-8.

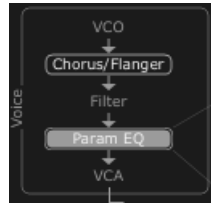

Connections of the voice effects

6.4.1 The effects are accessible when you click on the "EFFECTS" tab, situated on the LCD screen, on the right part of the Jupiter-8V. They will be activated or deactivated when you click on the "EFFECT" button, situated on the toolbar. Chorus / Flanger

This monophonic Chorus/Flanger module adds a comb filtering aspect to the sound.

RATE Knob to set the frequency of the chorus

DEPTH Knob to set the depth of the modulation

FEEDBACK Knob to set the feedback of the modulation. (to achieve more of a flanged effect)

AMOUNT Knob to set the depth of the modulation

DRY/WET Knob to set the balance between the original signal and the output of the effect

OUTPUT Knob to set the output volume of the chorus

The "MOD" display allows accessing the modulation connections of each of the parameters of the chorus as well as the choice of the sources of modulation:

- KEY FOLLOW
- VELOCITY
- AFTERTOUCHE
- ENVELOPE 1
- ENVELOPE 2
- GALAXY Y
- GALAXY X
- LFO
- SEQUENCER

The "BYPASS" button deactivates the Chorus / Flanger effect.



6.4.2 The Chorus/FlangerDistortion

The distortion unit brings a soft or strong saturation to the sound, on the output of the VCO or VCF. Three modes of distortion are available:

DRY/WET Knob to set the balance between the original signal and the output of the effect.

DRIVE Sets the distortion amount.

OUTPUT Knob to set the output volume of the distortion.

The LCD screen allows to graphically show the distortion curve.

The "MOD" display allows accessing the modulation connections for each of the parameters of the distortion as well as the choice of the sources of modulation:

- KEY FOLLOW
- VELOCITY
- AFTERTOUCHE
- ENVELOPE 1
- ENVELOPE 2
- GALAXY Y
- GALAXY X
- LFO
- SEQUENCER

The "BYPASS" button deactivates the distortion effect.

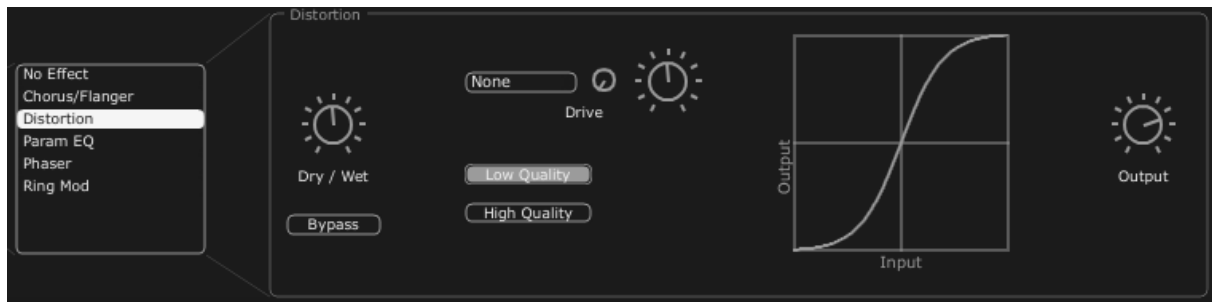

Distortion

6.4.3 Parametric EQ

This equalizer unit adjusts the harmonic content of the sound with four bands of frequency control.

Bands 1 and 4 (low and high) are semi-parametric; bands 2 and 3 (mid) are fully parametric.

Each of the parameters of the equalizer can be modulated by sources of modulation. This allows you to create effects that sweep frequencies, resulting in a complex «phasing» or filtering effect.

BAND 1 (bass frequencies)

FREQUENCY (F) Knob to set the band of the bass frequencies

GAIN (G) Knob to set the gain of the bass frequency band

BAND 2 (Mid-low frequencies)

FREQUENCY (F) Knob to set the band of the mid-low frequencies

GAIN (G) Knob to set the gain for the band of the mid-low frequencies

BAND WIDTH (Q) The setting of the band width of the mid-low frequencies

BAND 3 (Mid-high frequencies)

FREQUENCY (F) Knob to set the band of the mid-high frequencies

GAIN (G) Knob to set the gain for the band of the mid-high frequencies

BAND WIDTH (Q) The setting of the band width of the mid-high frequencies

BAND 4 (High frequencies)

FREQUENCY (F) Knob to set the band of the high frequencies

GAIN (G) Knob to set the gain for the band of the high frequencies

DRY/WET Knob to set the balance between the original signal and the output of the effect

OUTPUT Knob for the PARAM EQ's output volume.

The LCD screen allows you to graphically show the positions of each band.

The "MOD" button allows accessing the modulation connections for each of the parameters of the PARAM EQ as well as the choice of the sources of modulation:

- KEY FOLLOW
- VELOCITY
- AFTERTOUCH
- ENVELOPE 1
- ENVELOPE 2
- GALAXY Y
- GALAXY X
- LFO
- SEQUENCER

The "BYPASS" button allows deactivating the parametric equalizer effect.

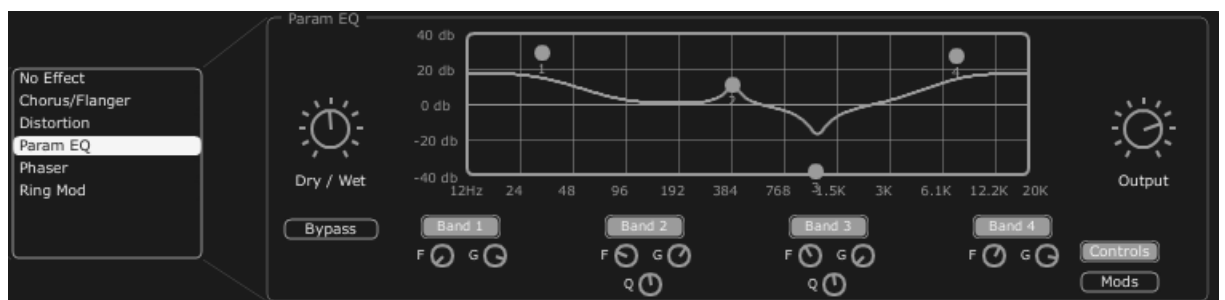

6.4.4

Parametric EQPhaser

The PHASER effect provides a classic phasing sound similar to analog effects used in the 70's.

SWEEP START Knob to set the reference frequency

FEEDBACK Knob to set the feedback of the modulated signal

SWEEP AMOUNT Knob to set the amplitude of the modulation

SWEEP RATE Knob to set the speed of the modulation

DRY/WET Knob to set the balance between the original signal and the output of the effect

OUTPUT Knob for the volume of the output of the phaser.

The "MOD" display allows accessing the modulation connections for each of the parameters of the PHASER as well as the choice of the sources of modulation:

- KEY FOLLOW

- VELOCITY
- AFTERTOUCHE
- ENVELOPE 1
- ENVELOPE 2
- GALAXY Y
- GALAXY X
- LFO
- SEQUENCER

The "BYPASS" button allows deactivating the PHASER effect.



6.4.5

PhaserRing Mod

The RING MODULATOR allows adding metallic effects to the sound with modulation of the output of the VCO or filter VCF.

MOD FREQ Knob to set the speed of the modulation

MOD AMOUT Knob to set the amplitude of the modulation

DRY/WET Knob to set the balance between the original signal and the output of the effect

OUTPUT Knob for the volume of the output of the ring modulator.

The "MOD" display allows accessing the modulation connections for each of the parameters of the RING MOD as well as the choice of the sources of modulation:

- KEY FOLLOW
- VELOCITY
- AFTERTOUCHE
- ENVELOPE 1
- ENVELOPE 2
- GALAXY Y
- GALAXY X
- LFO
- SEQUENCER

The "BYPASS" button allows deactivating the RING MOD effect.

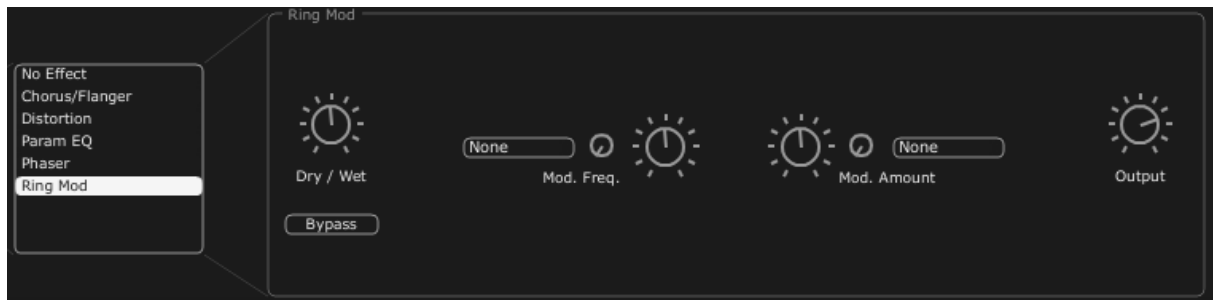

Ring Mod

6.5 PATCH EFFECTS

Two "PATCH" effect modules are available on the end of the synthesis chain. The two modules are placed after the output of the VCA, and cannot receive external modulations.



6.5.1 Patch effect connections Chorus/Flanger

The stereo Chorus/Flanger module adds thickness and width to the sound. This effect is often used to create string pads for example (the "Ensemble" effect of old analog synthesizers)

- RATE** Knob to set the frequency of the chorus
- DEPTH** Knob to set the depth of the modulation
- FEEDBACK** Knob to set the feedback of the modulation, to achieve more of a flanged effect
- AMOUNT** Knob to set the depth of the modulation
- DRY/WET** Knob to set the balance between the original signal and the output of the effect
- OUTPUT** Knob to set the output volume of the chorus

The "BYPASS" button allows deactivating the "CHORUS/ FLANGER" effect.

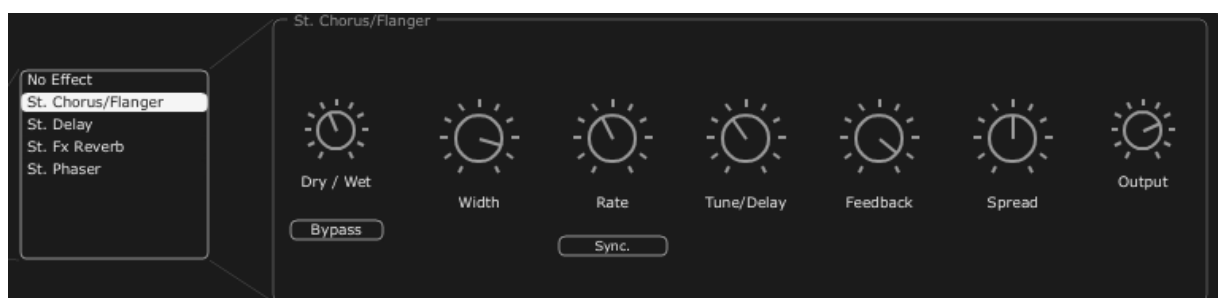

6.5.2 Chorus / Flanger Stereo Analog Delay

The delay effect allows creating echo effects or doubling in the sound. This effect is used on all types of sounds to add stereo space.

This effect recreates the characteristics of the analog delays of the 70's, which are very popular today for their unique sound (the famous "tape delays").

- RIGHT TIME** Knob to set the time for the right channel
- LEFT TIME** Knob to set the time for the left channel
- FEEDBACK RIGHT** Knob to set the feedback for the right channel
- FEEDBACK LEFT** Knob to set the feedback for the left channel
- CROSS FEEDK R** Knob to set the feedback of the right channel towards the left channel
- CROSS FEEDK L** Knob to set the feedback of the left channel towards the right channel
- DAMPING** Knob to set the amount of high frequencies that are rolled off with each repetition
- DRY/WET** Knob to set the balance between the original signal and the output of the effect
- OUTPUT** Knob to set the output volume of the delay

The "BYPASS" button allows deactivating the delay effect

The "SYNC" button allows synchronize the delay to MIDI

The "LINK" button allows linking of the left and right channel of the delay.

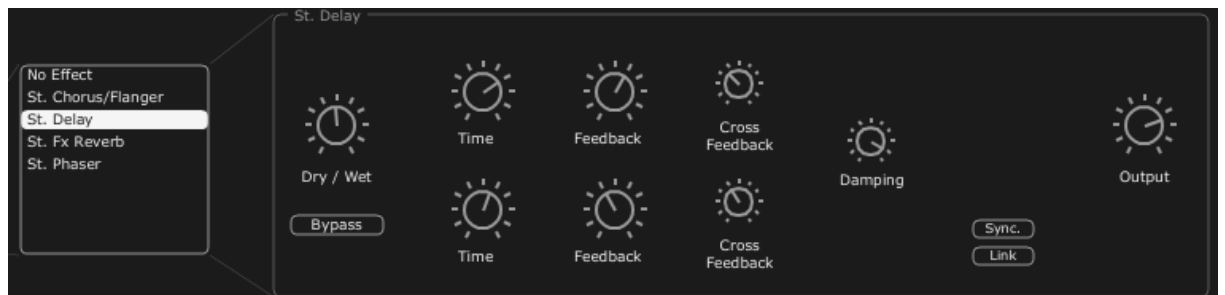

6.5.3 Stereo DelayReverb

The reverb effect creates a very dense series of decaying echoes in the sound, simulating the sound's performance within a three-dimensional space.

- FEEDBACK** Knob to set feedback time for the reverb
- DAMPING** Knob to set the rate at which high frequencies that are rolled off as the reverb decays
- DRY/WET** Knob to set the balance between the original signal and the output of the effect
- OUTPUT** Knob to set the output volume of the reverb

A visual interface shows the characteristics of the REVERB for convenient editing.

The "BYPASS" button allows deactivating the "REVERB" effect.



The Reverb effect

6.5.4 Dual Phaser

The Phaser unit provides a classic phasing sound similar to analog effects used in the 70's.

- SWEEP GENERATOR 1/2** Selection of the waveforms for the modulations of phasers 1 and 2:
 - Sin
 - Square
 - Saw
 - Triangle
- RATE 1/2** Knob to set the rate for Phaser 1 /2
- DEPTH 1/2** Knob to set the depth of the modulation for Phaser 1/2
- FEEDBACK 1/2** Knob to set feedback time for Phaser 1/2
- DRY/WET** Knob to set the balance between the original signal and the output of the effect
- OUTPUT** Knob to set the output volume of the DUAL PHASER
- SWEEP SYNC** Button allows activating the synchronization of the two modulation frequencies.
- INVERT** Button allows inverting the phase of the modulation frequencies
- BYPASS** Button allows deactivating the "DUAL PHASER" effect.

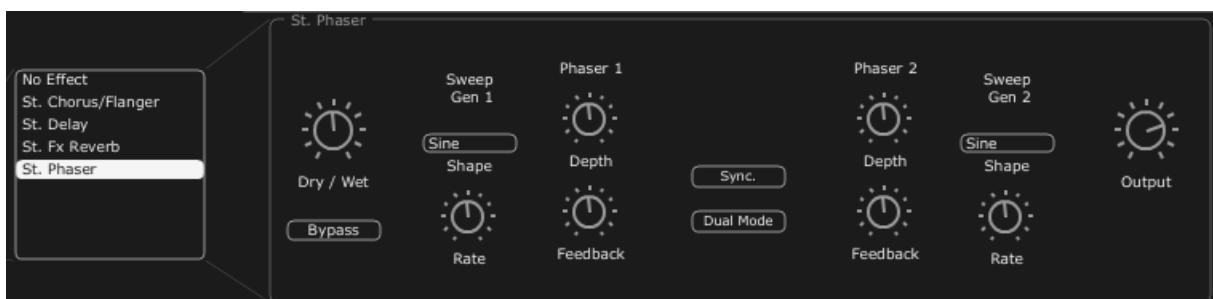

Dual Phaser

7 SOME ELEMENTS OF SOUND DESIGN

Here are five examples that can guide you when programming different tones on the Jupiter-8V. These tones are classified from simple to complex, and are organized in 3 parts:

- The first part will allow you to explore the basis of the subtractive synthesis with the Jupiter-8V. While starting off with a basic preset, you will make a polyphonic violin sound that is typical for this synthesizer. After that, you will approach the programming of a richer sound (complex modulations, cross modulation...) in the form of a bell tone.
- The second part will allow you to explore the newly added functionalities of the Jupiter-8V. After this the «Galaxy» and «Step Sequencer» modules will not be a mystery anymore!
- The third part will allow you to create a very rich and progressive tone thanks to the combination of the «voice» effects and numerous possibilities of modulations that have already been presented.

7.1 A POLYPHONIC VIOLIN PRESET MADE WITH THE JUPITER- 8 V

To begin, we will learn how to program a basic polyphonic sound. It will be simply composed of four elements:

- Two oscillators (VCO1 and 2)
- A high pass filter (HPF)
- A low pass filter (VCF)
- An ADSR envelope connected to the filter
- An ADSR envelope connected to the amplifier
- An LFO connected to the width of the "square" waveform of VCO2

By doing this you will obtain a basic preset offering an overall tone of violins. Figure 1 shows you the position of the different knobs.

- ▶ To begin, choose the preset "UJ Brass« in the project «KUJIE» / "Brass". As you will notice, the sound is very basic and not very alive when you play a note. In fact, this very simple preset (continuous and brilliant) is our starting point for the sound design.



Choose the preset « Default » of the project « Template »

- ▶ On VCO 1, the "SAW" wave form is selected. This waveform is very rich in harmonics and will be perfectly suitable to create the violin sound.

- ▶ Change the range of this oscillator (by octave). Click on the selector "Range" and place it on "16'"



Click on the "Range" selector of VCO1

- ▶ Choose the modulated square waveform on VCO2
- ▶

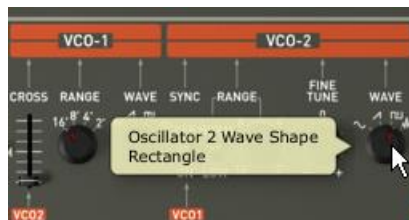

Choose the modulated square waveform on VCO2

- ▶ Set VCO 2 slightly out of tune by turning the "Fine Tune" knob a little bit. The sound will become more alive.



Set VCO 2 slightly out of tune

- ▶ Lower the cut off frequency of the filter («FREQUENCY») by positioning the knob in the center (around «400 Hz»). That will allow you to return to a softer sound. You will hear the effect that the envelope will produce on the filter.
- ▶

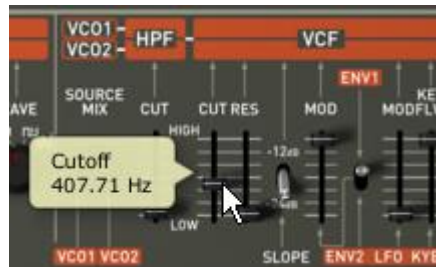

Lower the cut off frequency of the filter

- ▶ On the ADSR envelope situated to the right of the filter, increase the attack time to a value close to «100MS». Lower the knob of the Decay (set it to a value around 200 ms) and, finally, lower the Sustain toward «0.0.600.000». The maximum level of the cut off frequency is thus reduced.

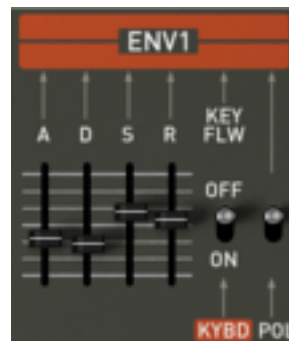

Increase the attack time

- ▶ Increase the position of the «PWM» selector (for «Pulse Width Modulation») to the center of its range. Place the situated switch to the right of the «PWM» selector to the position «LFO». Now it is set to modulate the width of the square with the LFO.
- ▶

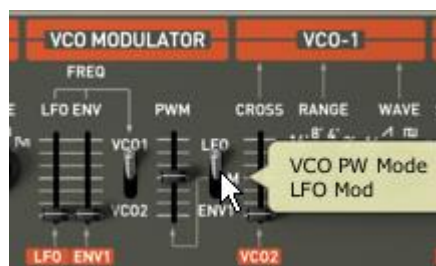

Increase the position of the «PWM» selector

- ▶ Increase the position of the LFO «Rate» slider to a position around 3 Hz. The achieved effect will be comparable to a chorus effect.



Increase the position of the LFO rate slider

- ▶ At this stage, you can add a little «Stereo Delay» effect to your tone in order to make it sound wider.
- ▶ Open the «Effects» page situated in the top panel of the Jupiter-8V.
- ▶ In the first «Patch» slot (at the bottom of the connection diagram of the effects), choose the «ST Delay».
- ▶ Set the times («Time») for each of the two sides of the stereo delay.
- ▶ You also can adjust the number of repetitions («feedback») to your convenience.
- ▶

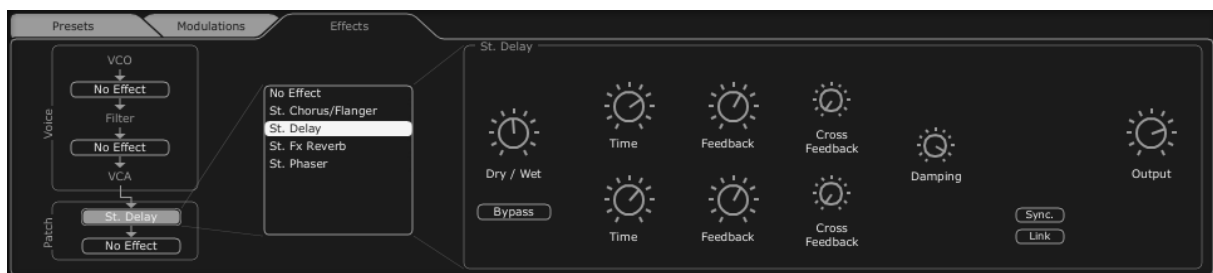

The Delay settings

- ▶ Save the sound as « Violin 1«, you will then be able to use it later. Open the preset interface and click on the «Save as» button. Choose a new name («Strings» for example). Also give a new name to the project (for example your name), a new name for the new preset Program (for example «Strings together») and give characteristics to this preset (for example «Strings» then «Bright» and «Simple»).

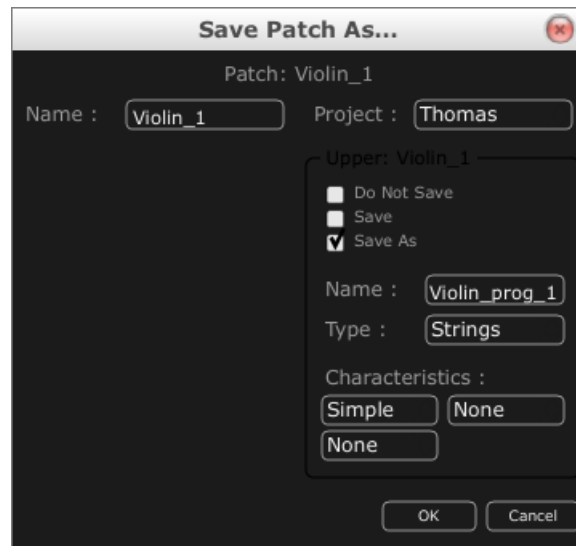

7.2 SAVE THE SOUND ARPEGGIATED SOUNDS

Load the preset "JMB_Bass1" in the "JMB" project. We are going to use the galaxy module and the arpeggiator to modulate the sound.

This preset will contain:

- Two VCO's
 - An high pass filter (HPF)
 - A low pass filter (VCF)
 - An ADSR envelope connected to the filter
 - An ADSR envelope connected to the amplifier
 - The Galaxy module
 - The Arpeggiator
 - Voice effect « Chorus / Flanger «
 - Patch effect « St Reverb «
 - Patch effect « St Delay «
- Increase the release time for the second ADSR envelope (for example to the range of 8000 ms) in order to give the impression of a harp tone.

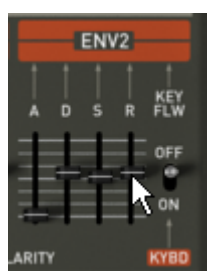

Increase the release time for the second ADSR envelope

- ▶ Increase the cut off frequency of the high pass filter (to the range of 800 Hz)
- ▶ Lower the resonance rate of the VCF almost to the minimum.
- ▶ Activate the arpeggiator by clicking on the buttons «Range 2» and «Mode UDN». Then play a chord on your MIDI keyboard. An arpeggio will be heard.
- ▶



Setting of the arpeggiator

💡 If you work with a MIDI Sequencer and you wish to synchronize the arpeggiator to the tempo of the sequencer, click on the switch «INT / EXT» situated next to the «Rate» fader of the arpeggiator then place it toward the bottom into the position «EXT»

- ▶ Click on the selector «Hold Up» if you wish to hold the arpeggio in play mode.
- ▶



Click on the « Hold Up » selector

We will use the Galaxy unit to modulate the width of the square wave form of the second VCO, the cut off frequency of the high pass filter and the low pass filter (VCF)

- ▶ Open the «Modulations» page situated in the upper panel of the Jupiter-8V. the Galaxy unit is selected by default.

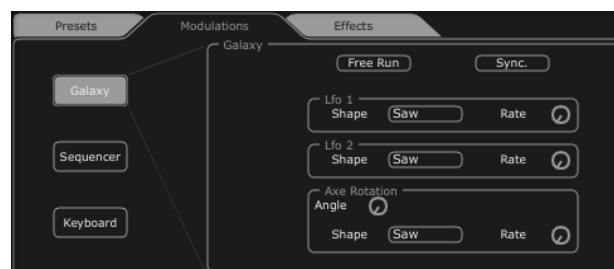

Open the «Modulations» page

- ▶ Choose the destination parameters of the modulations for LFO1 (Y output) and 2 (X output):
LFO1 → HPF Cutoff«

LFO2 → VCF Cutoff«

- ▶ Set the depth of these modulations with the knobs situated next to these destinations. (Take values around "0.900« for the HPF «Cutoff« and «0.500« for the «VCF Cutoff«)

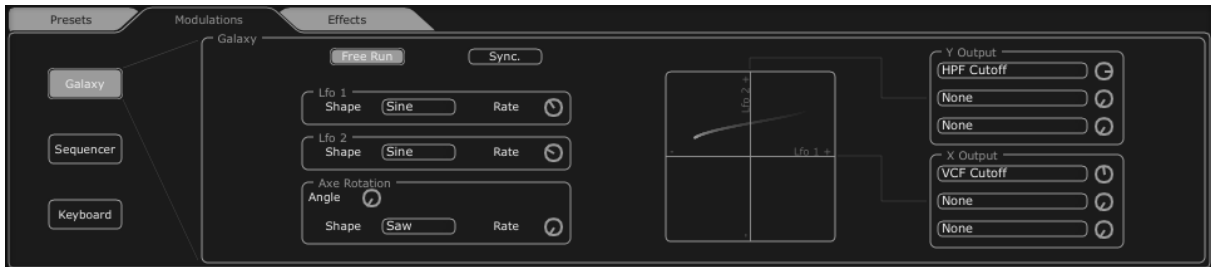

Settings of the galaxy unit

If you wish to give space to your sound, add chorus, reverb or delay effects. To do that, click on «Effects» situated in the upper panel of the Jupiter-8V.

- ▶ In the first «Voice» effect slot (at the top of the connection diagram for the effects), choose «Chorus / Flanger». This will be placed between the VCO and the filters.
- ▶ Set the speed of the chorus frequency with the («Rate») knob to your convenience
- ▶ You also can adjust the numbers of repetitions («feedback») to your convenience.
- ▶ Set the «dry/wet» knob of the chorus in a manner to balance between the original and the effected sound.

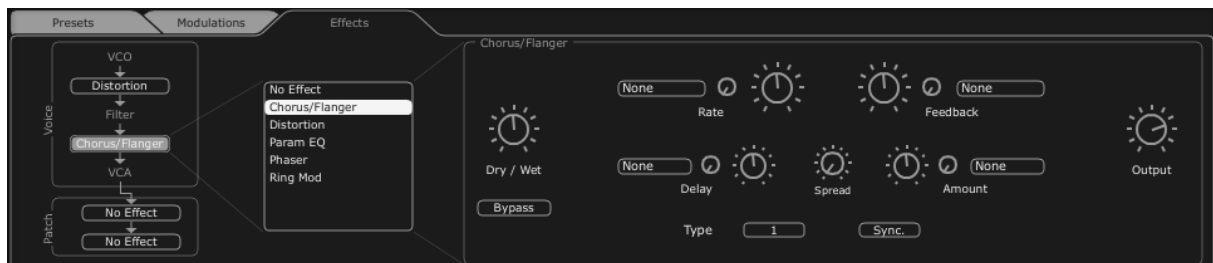

Setting of the Chorus

- ▶ In the first «Patch» effects slot (underneath the «Voice» effects on the connection diagram for the effects), choose «St FX Reverb»
- ▶ Set the «Size» knob toward the right to lengthen the time of reverberation. (Take a value around "0.700«)
- ▶ Set the «dry/wet» knob of the chorus in a manner to balance between the original and the effected sound.



Setting of the « St FX Reverb»

- ▶ In the second «Patch» effect slot, choose «St FX Delay»
- ▶ Set the times of the different delay lines («Time») for each of the two sides of the stereo delay so that they will be in sync with the arpeggiator.

💡 If you work with a MIDI Sequencer and you wish to synchronize the arpeggiator to the tempo of the sequencer, click on the «Sync» button.

- ▶ You also can adjust the numbers of repetitions («feedback») to your convenience.
- ▶

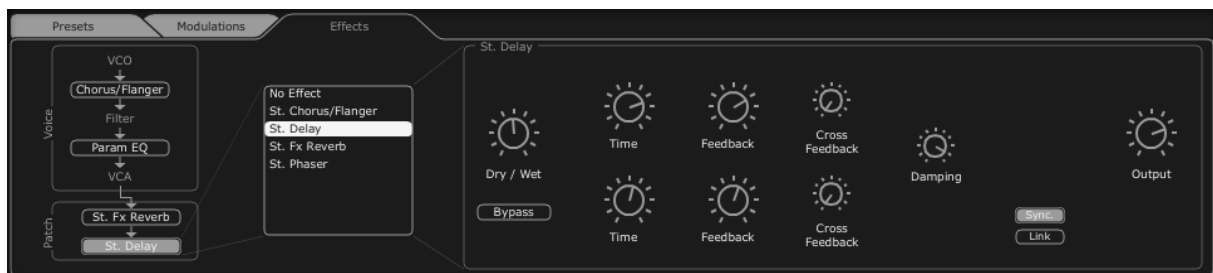

Setting of the St fx Delay

Now you can save your preset to be able to use it later.

7.3 A SEQUENCE WITH THE JUPITER-8V

In this example, you will discover the basics of programming a sequence on the Jupiter-8V. This can be done with the «32-step step sequencer». This will be used together with Galaxy unit and the St Delay effect to create rich and complex rhythmic effects.

Choose the preset «JMB_Sequenced Chords» in the project «JMB». This sound uses VCO2 tuned to a dominant 7th and is very «brilliant». This will be a starting point for our third preset.

- ▶ Open the interface of the «Sequencer» situated in the upper panel of the Jupiter-8V. Click on the «Sequencer» button.
- ▶

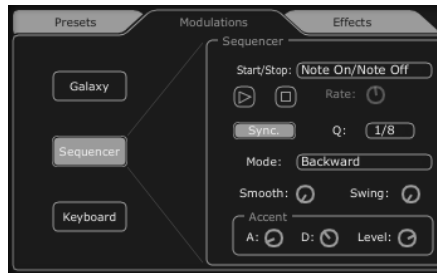

Open the interface of the «Sequencer»

- ▶ Click on the first list «Output» (situated to right of the sequencer) and choose «VCF Cutoff»



Choose «VCF Cutoff»

- ▶ Increase the value of the intensity of this modulation while turning the knob to the right.



Increase the amount of modulation

- ▶ Place the sequencer in MIDI SYNC mode by clicking on the button «Sync.» The synchronization to the MIDI tempo allows regulating the speed of the sequencer, Galaxy and St Delay precisely.
- ▶ Select the speed of the sequencer by clicking on the list «Q» (for «Quantized») choose the value "1/8«.

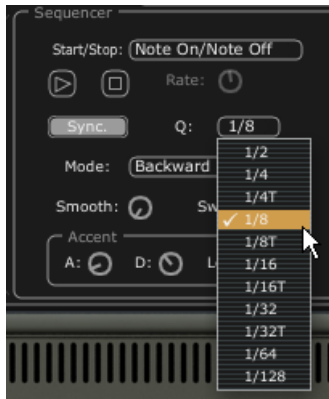

Choose the value "1/8"

- ▶ Select the number of steps that you wish to have in your sequence. Click on the left side of the bar situated on the top of the programming window. For example set it to 8 steps.



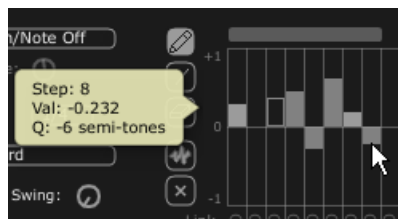

Set it to 8 steps

- ▶ Set the values of the different steps to your convenience while clicking on each of the vertical bars and pulling them up for positive values or down for negative values.



Set the values of the different steps

💡 Click on the  tool to create different values randomly for each note. This way, you will quickly obtain rhythmic sequences that you can edit to your liking.  .

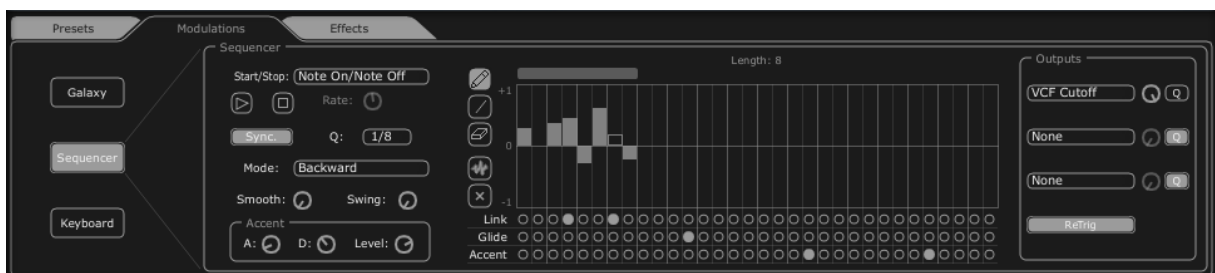

The interface of the Jupiter-8V sequencer

- ▶ Open the Galaxy module to complete the rhythm. This will modulate the volume of the VCA to create «gate» effects that are often used in electronic music.
- ▶ Click on «Output X' (situated to right of galaxy) and choose «VCA» as destination of modulation controlled by LFO 1 (axis «X»).
- ▶ Do the same for the first destination of the axis «Y» while choosing also the destination «VCA»
- ▶ Set the two levels of modulation to the range of 0.600
- ▶ Sync the Galaxy module to MIDI « Sync «
- ▶ Select the speed of the LFO while clicking on « Q « (For « Quantized «) select a value « 1/8 «.

Galaxy completes the sequence played by the step sequencer to finish your sound.



Setting of the Galaxy module

Finally the preset consists of:

- 2 VCOs (VCO2 as a 7th tuning)
- A high pass filter (HPF)
- A low pass filter (VCF)
- An ADSR envelope connected to the filter
- An ADSR envelope connected to the amplifier
- The Galaxy module
- The Arpeggiator
- The step sequencer modulating the frequency of the VCF
- The Galaxy module modulating the volume of the VCA
- A LFO modulating the square waveform of VCO2
- Patch effect « Chorus / Flanger «
- Patch effect « St Delay «

These sound examples present different levels of difficulty. We hope that they have allowed you to discover a part of the possibilities that the Jupiter-8V offers. But do not hesitate to do your own experimentations. This is the fastest way to master the Jupiter-8V and create original sounds.

8 MODES OF OPERATION

8.1 STANDALONE

The Jupiter 8V can be used as an instrument independently from a sequencer software (Standalone mode).

This allows you launch the application as a single instrument, and to play it using an external MIDI keyboard.

8.1.1 Launch the application

To launch the Jupiter 8V application,

- on Windows, go to the menu Start > Programs > Arturia > Jupiter-8V2, and choose "Jupiter-8V2".
- on Macintosh, open the finder > Applications > Arturia and double-click on the Jupiter-8V2 application icon.

8.1.2 Configuration of the instrument

Click on the "Settings" button on the Jupiter 8V toolbar. It will show the following "Audio Settings" dialog box.

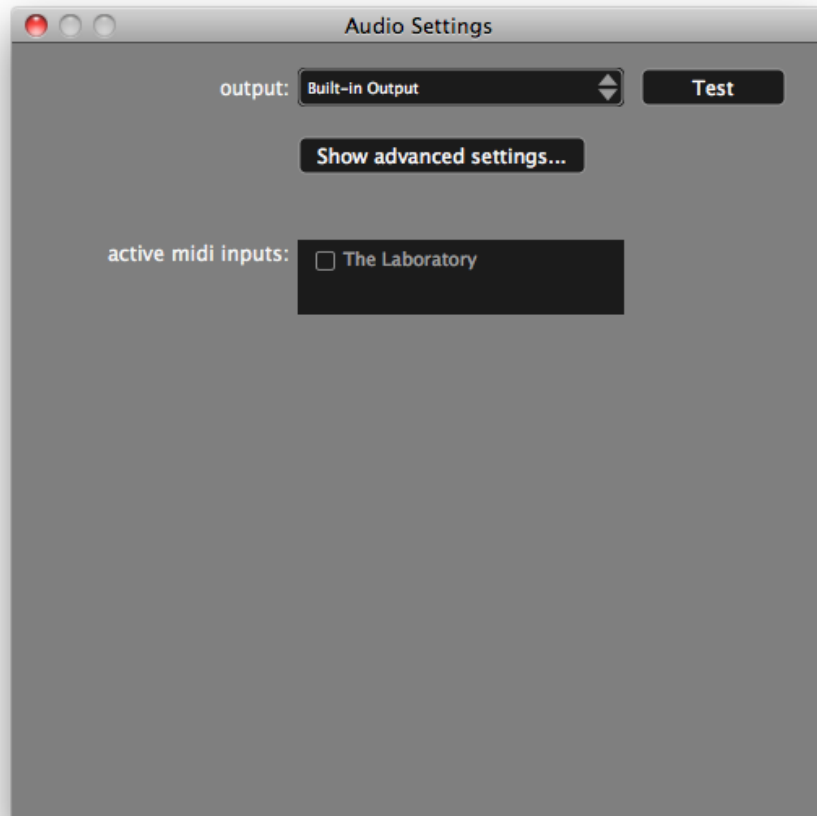

In this option menu you can:

- Set the audio output port
- Choose the audio interface
- Choose memory buffer size (smaller size will increase the load on the CPU but will reduce latency, and reciprocally)
- Choose sample rate between 44100 Hz and 96000 Hz
- Choose one or several active MIDI input port(s)

8.2 VST 2

VST (Virtual Studio Technology) is a plug-in standard created by Steinberg. It allows you to integrate software audio synthesizers and effect plug-ins with audio DAWs and host software. VST is supported by a large number of audio applications like Cubase, Nuendo, Wavelab, FL Studio, Audacity, Samplitude, Sonar, Audition, Live, etc.

The VST interface was updated to version 2 in 1999. One of the additions was the ability for plug-ins to receive MIDI data. This allowed for the introduction of VSTi (Virtual Studio Technology Instrument) format plug-ins.

8.3 VST 3

VST3 is a new update of VST audio plugins protocol. It was updated in 2008. This has improved performance over previous versions of VST and has many new features as well. Cubase 6 and Nuendo 5 are using this new protocol.

With VST3 on Windows, users do not have to choose a folder path to install the plug-in. The installer will put VST3 files automatically into the appropriate directory on your hard drive.

8.4 RTAS

RTAS, short for Real-Time AudioSuite is an audio plug-in developed by Digidesign (AVID technology) for their Pro Tools systems.

8.5 AU

AU for Audio Units is a plug-in protocol developed by Apple Computer. It used by Apple applications such as GarageBand, Soundtrack Pro, Logic Express, Logic Audio, Final Cut Pro, Mainstage, Ardour, Ableton Live, REAPER and Digital Performer.

8.6 64 BIT COMPATIBILITY

The Jupiter 8V is optimized for both 32-bit and 64-bit modes. If you have a 64-bit operating system and a 64-bit digital audio workstation, you should use 64-bit version of the plug-in (for Windows).

Usually on 32-bit Windows, all 32-bit programs are installed in C:\Program Files. However on 64-bit Windows, you can find the 64-bit programs in C:\Program Files\ and the 32-bit programs in C:\Program Files (x86)\.

Mac users don't have to bother with this, because the same plug-in file contains both the 32-bit and the 64-bit versions, and the host automatically chooses the better one.

8.7 USE IN CUBASE/NUENDO (VST)

8.7.1 Instrument use in VST mode

The opening of a Jupiter 8V VST plug-in is the same as opening all other VST plug-ins. Please consult the instruction manual of your host sequencer for more specific information. Under Cubase/Nuendo, create a new "Instrument" track, and choose Jupiter-8V2 in the rack.

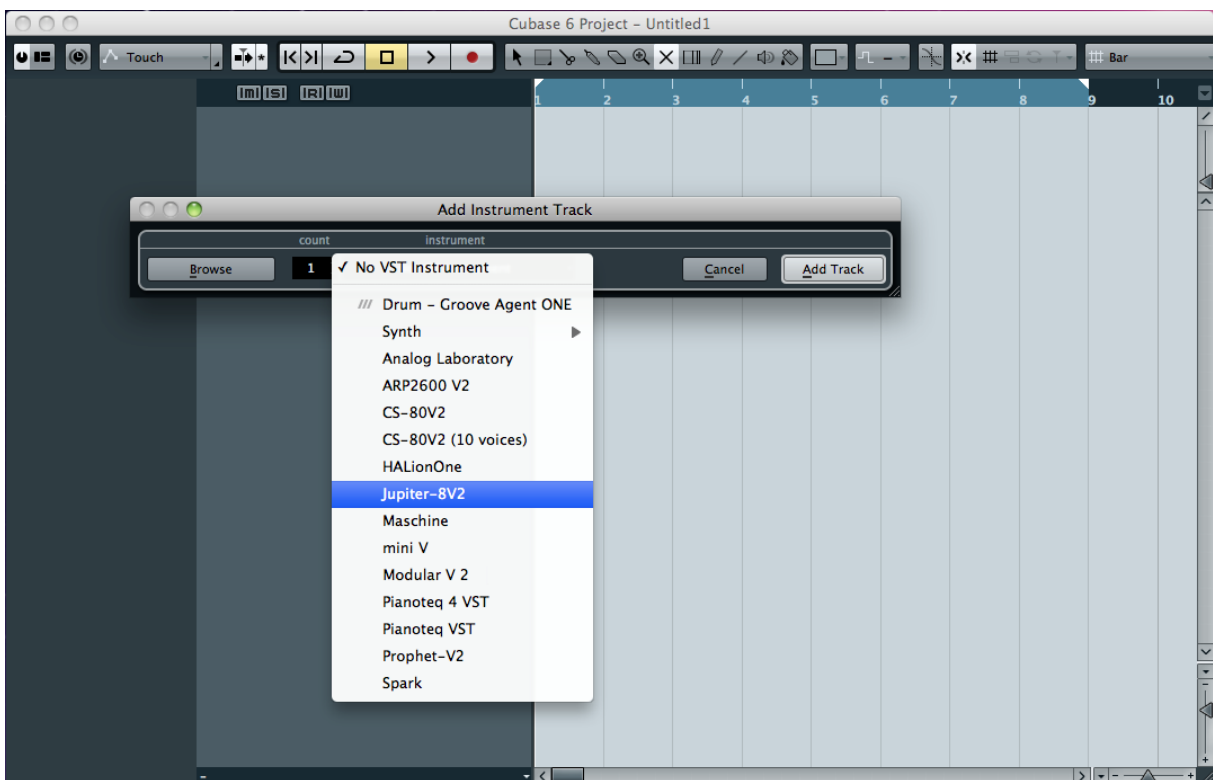
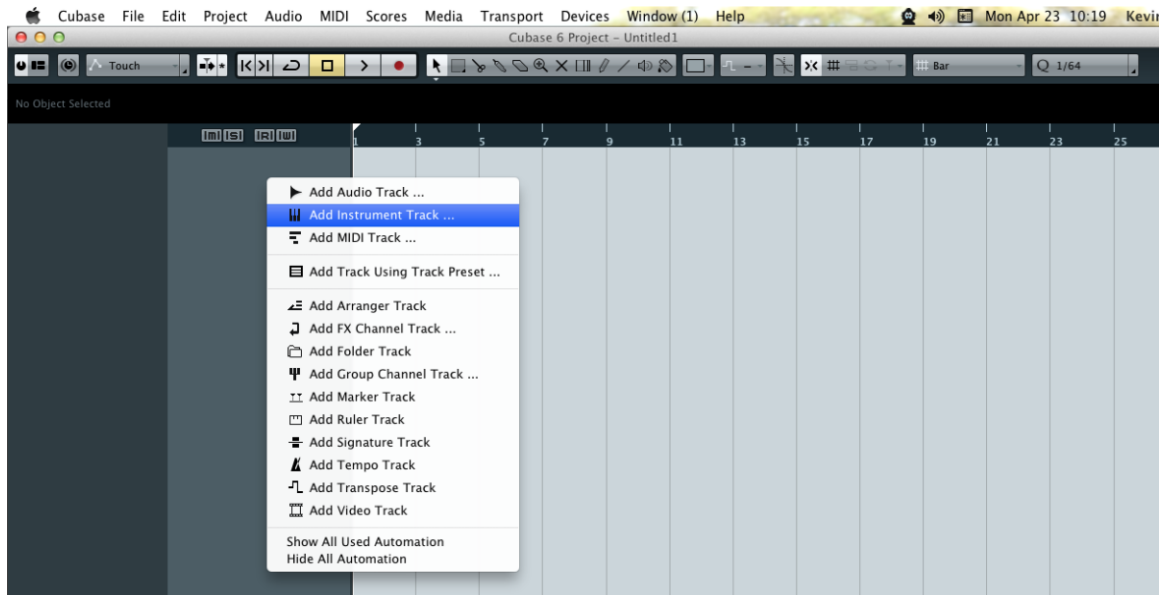

8.7.2 Rescan the plug-in directory in Cubase

If the Jupiter 8V does not appear in the list of VST plug-ins, you can perform a "rescan" of the plug-in directory.

8.7.3 Saving of presets

When the session/project is saved, the Jupiter 8V is saved in its last mode of operation, with all modifications intact. For instance, if you were working on a "P1" preset in which you had modified parameters (without saving them as a separate

preset within the plug-in itself), the next time you open the project, the Jupiter 8V will load the "P1" preset plus the modifications you made previously.

The drop-down menu in which the VST sequencer allows you to save a new preset is of course usable with the Jupiter 8V. However, it is highly advised to use the Jupiter 8V internal menu: the presets saved in this way are usable in any other mode (standalone or with other sequencers), they can be exported and exchanged more easily, and they will remain compatible with Jupiter 8V future versions.

8.8 USING IN PRO TOOLS (RTAS)

8.8.1 Opening of the plug-in

Access to the Jupiter 8V plug-in is like all other plug-ins in Pro Tools, via a new Instrument Track creation:

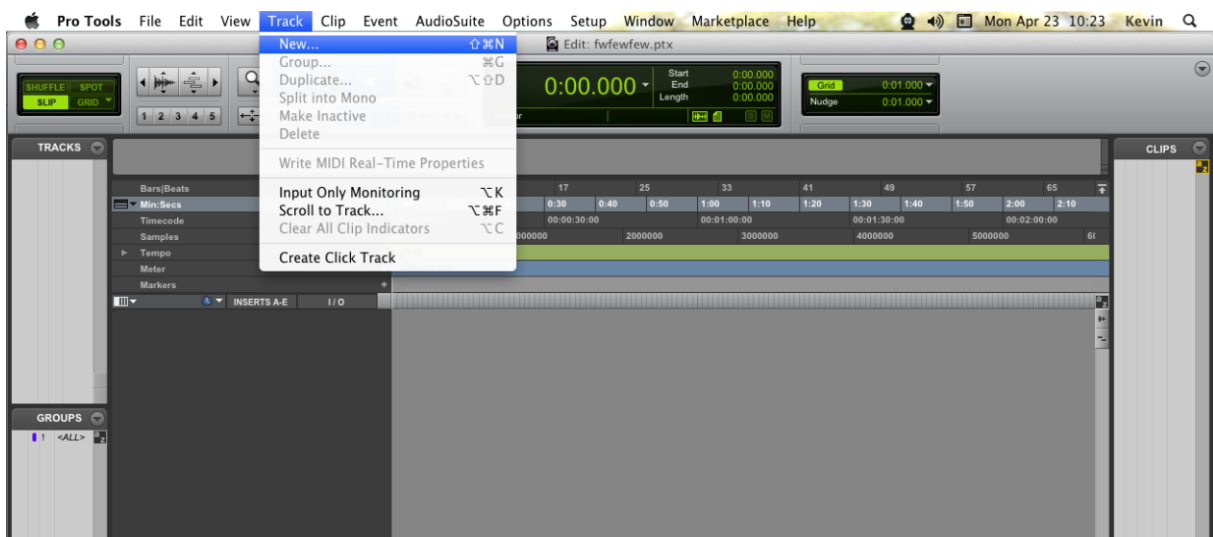



The Jupiter 8V must be loaded on an instrument stereo track. We can now make Jupiter 8V sound by playing with the mouse on the virtual keyboard.

8.8.2 Saving the presets

When the session/project is saved, Jupiter 8V is saved in its last mode of operation, with all modifications intact. For instance, if you were working on a "P1" preset in which you had modified parameters (without saving them as a separate preset within the plug-in itself), the next time you open the project, the Jupiter 8V will load the "P1" preset plus the modifications you made previously.

The drop-down menu in which the VST sequencer allows you to save a new preset is of course usable with the Jupiter 8V. However, it is highly advised to use the Jupiter 8V internal menu: the presets saved in this way are usable in any other mode (standalone or with other sequencers), they can be exported and exchanged more easily, and they will remain compatible with the Jupiter 8V future versions.

8.8.3 Automation under Pro Tools

The automation function with Jupiter 8V functions like with all RTAS/HTDM plug-ins (check the Pro Tools documentation for more details on plug-in automations).

8.9 USING IN LOGIC, MAC OS X (AU)

Make sure the plug-in has been tested OK in the Logic Audio Units Manager. To launch it, click on the menu "Preferences > Start Logic AU Manager".

Create a new Software Instrument track.

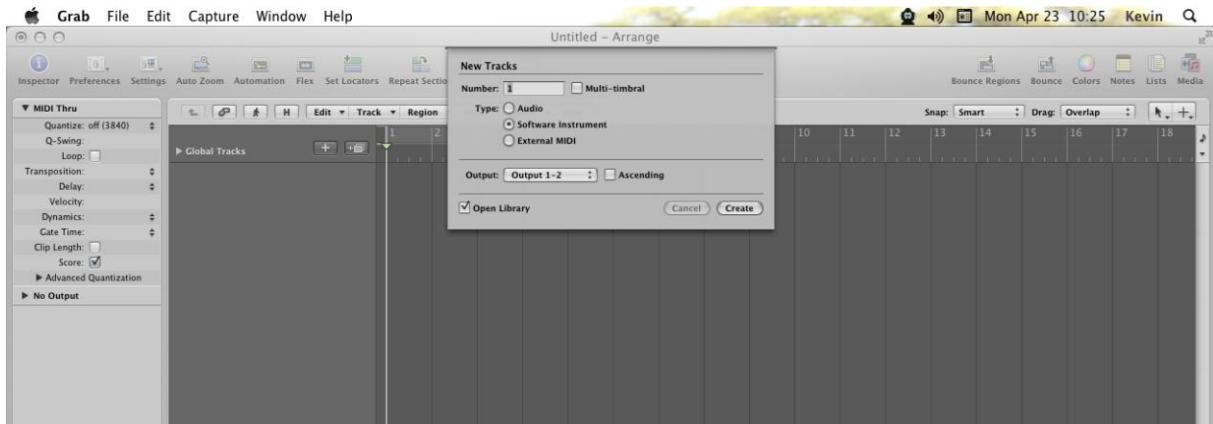

On the channel of the mixer corresponding to the selected track, click on the button "I/O" to list the available plug-ins, then select "AU Instruments > Arturia > Jupiter-8V2 > Stereo".

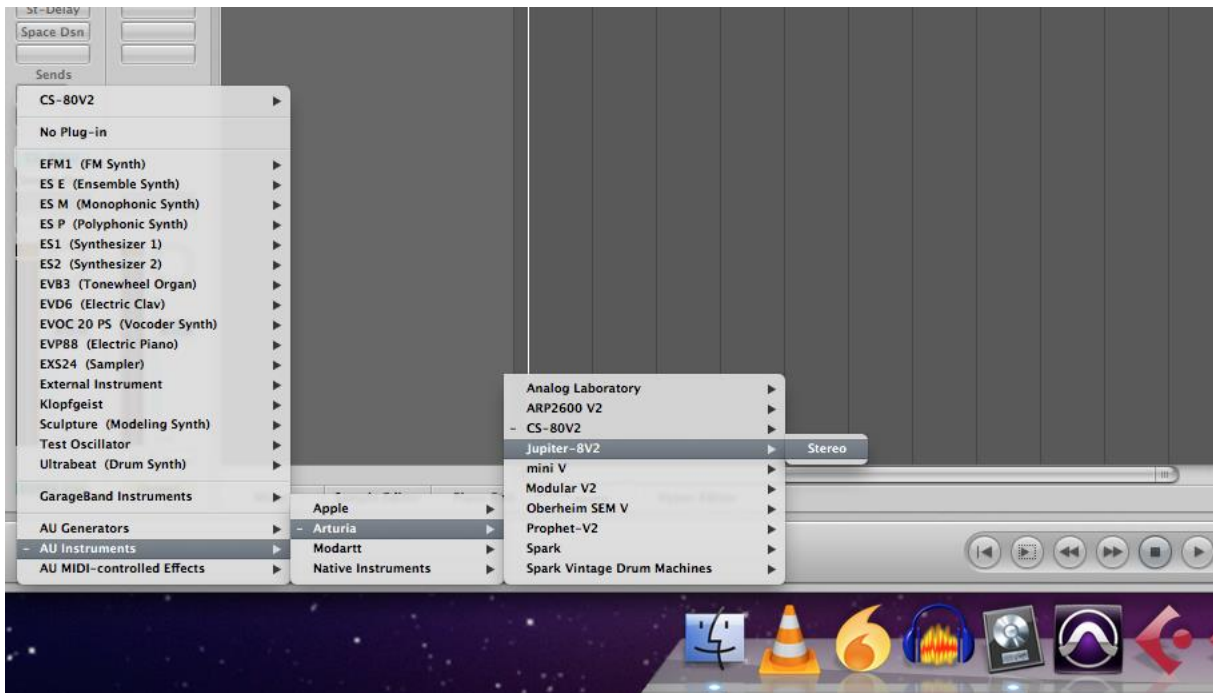

8.10 USING IN ABLETON LIVE (AU AND VST)

From the plug-ins tab, simply double click on the Jupiter-8V2 VST or AU icon, or drag-and-drop the plug-in into a MIDI track:

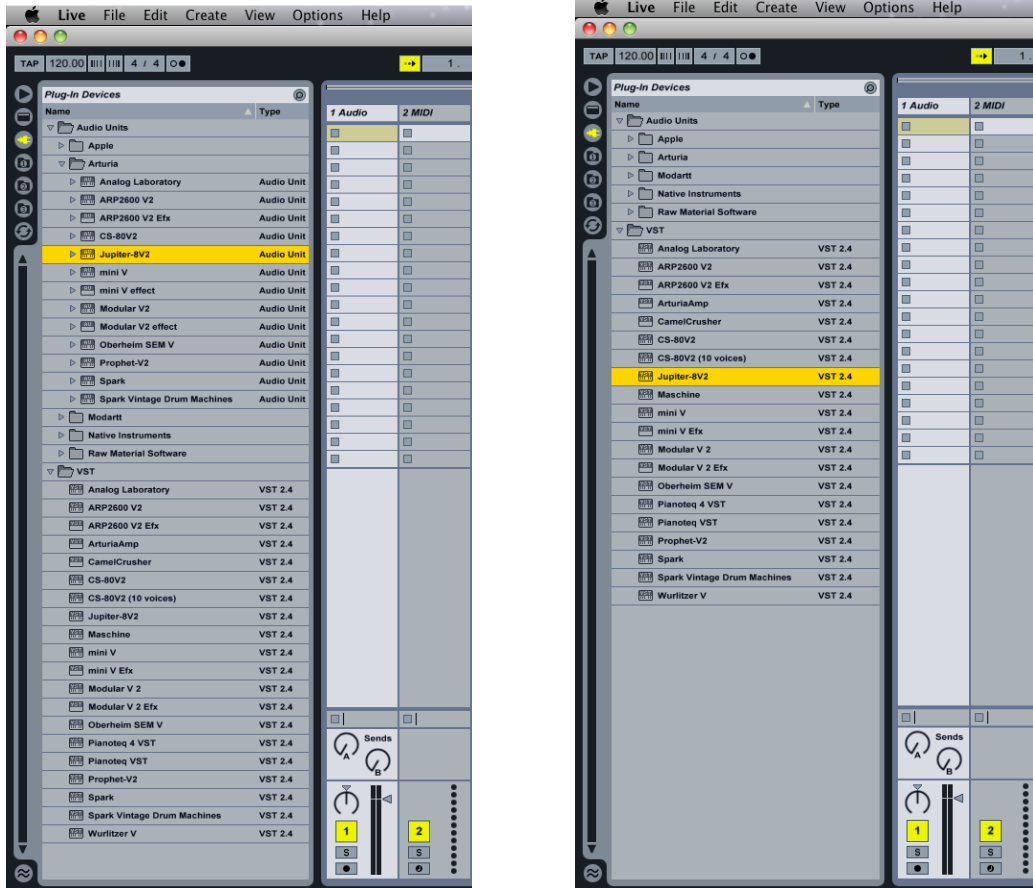

If necessary, you can perform a rescan of the plug-in directory in the Preferences, "File Folder" tab: press the "Scan" button, or press "Scan" while holding the [Alt] key for a full rescan.

9 ARTURIA JUPITER-8V - LICENSE AGREEMENT

1. General

1.1 In consideration of payment of the Licensee fee, which is a portion of the price you paid, Arturia, as Licensor, grants to you (hereinafter termed "Licensee") a nonexclusive right for the use of software including related media, documentation (for example program descriptions, manuals) and other documents and materials manufactured by Arturia SA ("Product(s)").

All intellectual property rights in the software belong to Arturia SA (hereinafter: "Arturia").

1.2 The following editions of the Product are available: "**Demo**", "**Standard**", "**EDU**" and "**NFR**". Whilst each edition equips the User with the same software, the editions vary as regards both the scope of functions activated in the Product, and the rights of use granted under this EULA.

1.3 By installing the software on your computer you agree to these terms and conditions. If you do not approve these terms and conditions, you must not install this software.

1.4 If you do not approve these terms and conditions, please return the complete Product (including all written matter, packaging and similar material) to the dealer from whom it was originally bought within 14 (fourteen) days after the day of purchase. For purchases from the Arturia Online Store, please contact Arturia on the internet website: www.arturia.com/support/askforhelp/purchase.

1.4 Arturia reserves all rights not expressly granted in the EULA.

2. Right of use

2.1 The Product is protected by copyright. The Licensee may not lease, loan or sub-license the software. The Licensee is not authorized to modify the software.

2.2 Owning any product provided to the Licensee as "**Standard**" version grants the Licensee a non-exclusive right to use the Product in perpetuity including commercial purposes. The Licensee can activate the Product on up to five computers, as long as only one installation is used at any given time. The Licensee must register the Product to Arturia to get access to client support, and to activate his Product. (An internet connection is required to register and activate the Product, either on the computer on which the Product is installed, either on another device able to exchange files with the computer on which the Product is installed). Owning a license of the Products entitles the Licensee to get access to the future updates of this Product.

2.3 Any Products provided to you as "**NFR**" (Not For Resale) version grants the Licensee a non-exclusive right to use the Product for a limited period of time. The

Product shall only be used for demonstration, testing and evaluation purposes. NFR Products must not be used for commercial purposes, and must not be resold or transferred. The Licensee can activate the Product on up to five computers, as long as only one installation is used at any given time. The Licensee must register the Product to Arturia to get access to client support, and to activate his Product. (An internet connection is required to register and activate the Product, either on the computer on which the Product is installed, either on another device able to exchange files with the computer on which the Product is installed). NFR Products are exempt from update, upgrade or crossgrade offers, and cannot be purchased with or exchanged for vouchers or coupons. Furthermore, as an owner of a NFR Product, you are not entitled to any vouchers that ship with the standard version of the Product.

2.4 Any Products labelled or otherwise provided to you as an **“Educational”** version grants the Licensee a non-exclusive right to use the Product in perpetuity. The Product shall only be used by students or those working in educational institutions. This definition includes students, faculty, staff and administration attending and / or working at an educational institutional facility: private / public schools, colleges, universities and similar. These Products must not be used for commercial purposes, and must not be resold or transferred. The Licensee can activate the Product on up to five computers, as long as only one installation is used at any given time. The Licensee must register the Product to Arturia to get access to client support, and to activate his Product. (An internet connection is required to register and activate the Product, either on the computer on which the Product is installed, either on another device able to exchange files with the computer on which the Product is installed). These Products are exempt from upgrade or crossgrade offers, and cannot be purchased with or exchanged for vouchers or coupons. Furthermore, as an owner of an educational Product, you are not entitled to any vouchers that ship with the standard version of the Product.

2.5 Any Products labelled or otherwise provided to you as a **“Demo”** version grants the Licensee a right to use the Product only for demonstration and evaluation purposes. These Products must not be used for commercial purposes, and must not be resold or transferred. These Products are exempt from upgrade or crossgrade offers, and cannot be exchanged for vouchers or coupons.

3. No Unbundling

Bundles (product bundles are an association of software and hardware or software-only products) can only be resold / transferred as a whole. The individual components of a bundle must not be resold / transferred separately.

4. Resell

4.1 Renting or lending the licensed Software to a third party is expressly forbidden. Apart from that and if not provided otherwise within this EULA.

4.2 Except if otherwise stated within this EULA, Licensee may resell the software to a third party or transfer the software permanently free of charge, provided the third party agrees in writing with this EULA and Licensee ceases all use of the software, completely removes all installed copies of the software from his computers and – if the software was not purchased via download – deletes or transfers the original media delivered with the software to the third party. In addition, Licensee is required to de-register the purchased software with Arturia (more information available on www.arturia.com).

5. In case a sound library is part of the purchased Product the following shall apply in addition to the EULA

The provided samples, instruments and presets can be used for commercial or non-commercial music and audio Productions without the prior permission from Arturia under the terms of this Agreement. The usage of this Product (in particular samples, instruments and presets) for the creation of a sound library or as a sound library for any kind of synthesizer, virtual instrument, sample library, sample-based Product or other musical instrument is strictly prohibited. Individual samples, sound sets or audio loops may not be distributed (commercially or otherwise) standalone. Furthermore these samples, sound sets or audio may not be repackaged in whole or in part as audio samples, sound libraries or sound effects.

6. Data Protection

Arturia attaches great importance to compliance with legislation on data protection. The User data collected are used exclusively for performing its contractual obligations. No data is passed on to third parties. Further information can be obtained from our Privacy Policy at www.arturia.com/privacy.

7. Limited Warranty

Arturia warrants that the physical media on which the software is provided is free from defects in materials and workmanship under normal use for a period of thirty (30) days from the date of purchase. The Licensee's invoice shall be evidence of the date of purchase. Any implied warranties on the software are limited to thirty (30) days from the date of purchase. Some states do not allow limitations on duration of an implied warranty, so the above limitation may not apply to the Licensee in this case. All programs and accompanying materials are provided "as is".

8. No Liability for Consequential Damages

Neither Arturia nor anyone else involved in the creation, production, or delivery of this Product shall be liable for any direct, indirect, consequential, or incidental damages arising out of the use of, or inability to use this Product (including without limitation, damages for loss of business profits, business interruption, loss of business information and the like) even if Arturia was previously advised of the possibility of such damages. Some states do not allow limitations on the length of an implied warranty or the exclusion or limitation of incidental or consequential damages, so the above limitation or exclusions may not apply to the Licensee in this case. This warranty gives the Licensee specific legal rights, and the Licensee may also have other rights which vary from state to state.