

**USER'S MANUAL**

# **ARP2600 V**



**ARTURIA**®  
YOUR EXPERIENCE • YOUR SOUND

---

**Programming:**

Robert Bocquier (v2.0)  
Emilie de Fouchécour (v2.0)  
Vincent Travaglini (v2.0)  
Nicolas Bronnec  
Sylvain Gubian  
Xavier Oudin  
Cedric Rossi

**Graphics:**

Morgan Perrier (v2.0)  
Yannick Bonnefoy

**Manual:**

Robert Bocquier (v2.0)  
Antoine Back (v2.0)  
Jean-Michel Blanchet  
Yuji Sano  
Tom Healy  
Mitsuru Sakaue  
Xavier Oudin  
Cedric Rossi  
Kentaro Wakui

**Sound Designers:**

Jean-Michel Blanchet  
Celmar Engel  
Klaus Schulze  
Ruff & Jam  
Kevin Lamb from Neptunes  
Chris Pitman  
Silvère Letellier (v2.0)  
Noritaka Ubukata  
Darrell Diaz  
Glen Darcy  
Katsunori Ujiie  
Pietro Caramelli

**Very special thanks to:**

Celmar Engel, Mark Vail, Alan R. Perlman, Wally Badarou, Chad from Neptunes

**Thanks to:**

John Leimseder, Matt Lupo, Ron Kuper, Mephistoff Ellys, Pietro Caramelli  
and the numerous beta testers.

© ARTURIA SA – 1999-2014 – All rights reserved.

30, Chemin du Vieux Chêne

38240 Meylan

FRANCE

<http://www.arturia.com>

Information contained in this manual is subject to change without notice and does not represent a commitment on the part of Arturia. The software described in this manual is provided under the terms of a license agreement or non-disclosure agreement. The software license agreement specifies the terms and conditions for its lawful use. No part of this manual may be produced or transmitted in any form or by any purpose other than purchaser's personal use, without the express written permission of ARTURIA S.A.  
Other products, logos or company names quoted in this manual are trademarks or registered trademarks of their respective owners.

**November 2014 edition**

# Table of Contents

1	Introduction	5
1.1	The birth of ARP Instruments and the ARP2600	5
1.2	A better emulation thanks to TAE®	6
1.2.1	Aliasing-free oscillators	6
1.2.2	A better reproduction of analog oscillator waveforms	7
1.2.3	A better reproduction of analog filters	8
1.2.4	Ring modulator	8
2	ACTIVATION & FIRST START	9
2.1	Register & Activate	9
3	Quick start	10
3.1	Using presets	10
3.1.1	Now modify a preset	11
3.2	The 3 sections of the ARP2600 V	13
3.3	Overview of the Synthesizer	13
3.4	The sequencer	16
3.4.1	The ARP sequencer	16
3.4.2	The LFO	19
3.5	The effects	20
3.5.1	Chorus	20
3.5.2	Delay	21
3.6	Real-time controllers and MIDI assign	22
4	The interface	23
4.1	Using the presets	23
4.1.1	Choice of bank, sub-bank, preset	23
4.1.2	Creation of a bank, sub-bank, preset	24
4.1.3	Saving a user preset	24
4.1.4	Importation / Exportation of a preset bank	25
4.2	Use of controllers	26
4.2.1	Vertical linear potentiometers	26
4.2.2	Horizontal linear potentiometers	26
4.2.3	Knobs	26
4.2.4	The selectors:	27
4.2.5	Switches	27
4.2.6	Pitch Bend	27
4.3	Using cables	27
4.3.1	Audio and modulation connections	27
4.3.2	Modifying a connection	29
4.3.3	Setting the level of modulation	29
4.3.4	Separate the cables	30
4.3.5	Virtual keyboard	30
4.3.6	MIDI control	31
4.4	The sound map	34
4.4.1	The MAP main interface	35
4.4.2	The Sound Map overview	37
4.4.3	The LIST preset manager	39
4.4.4	The COMPASS morphing interface	40
5	The modules	43
5.1	Sound programming cabinet	43
5.1.1	Description	43
5.1.2	The Oscillators (VCO)	44
5.1.3	The Filter (VCF)	47

5.1.4	The envelopes	50
5.1.5	Output amplifiers (Voltage Control Amplifier - VCA)	52
5.1.6	Noise Generator	52
5.1.7	Voltage processor (Mixer / inverter / lag generator)	53
5.1.8	Sample and Hold generator	53
5.1.9	The "electronic switch" module (Electronic switch)	54
5.1.10	Envelope follower	55
5.1.11	Ring modulator	55
5.1.12	"Tracking" generator	56
5.1.13	Reverberation	57
5.1.14	Chorus and delay effects	58
5.1.15	Control voltages (CV control)	58
5.2	Keyboard interface (Model 3620)	59
5.3	Low frequency oscillator (LFO)	60
5.4	The ARP sequencer	60
<b>6 The basics of subtractive synthesis</b>		<b>63</b>
6.1	The three main elements	63
6.1.1	The oscillator or VCO	63
6.1.2	The filter or VCF	67
6.1.3	The amplifier or VCA	69
6.2	Complementary modules	70
6.2.1	The keyboard	70
6.2.2	The envelope generator	71
6.2.3	The low frequency oscillator	72
6.2.4	The ring modulator	73
6.2.5	Sample and hold	73
<b>7 A few elements of sound design</b>		<b>75</b>
7.1	Simple patch without cabling	75
7.2	Polyphonic patch with cabling	78
7.3	Special effects patch with the help of the tracking generator	81
7.4	Patch using the sequencer to create a melody	84
7.5	Patch using the sequencer to create a modulation sequence	86
<b>8 Modes of operation</b>		<b>88</b>
8.1	Standalone	88
8.1.1	Launch the application	88
8.1.2	Configuration of the instrument	88
8.2	VST 2	89
8.3	VST 3	89
8.4	RTAS	89
8.5	AU	89
8.6	64 bit compatibility	89
8.7	Use in Cubase/Nuendo (VST)	90
8.7.1	Instrument use in VST mode	90
8.7.2	Rescan the plug-in directory in Cubase	91
8.7.3	Saving of presets	91
8.8	Using in Pro Tools (RTAS)	91
8.8.1	Opening of the plug-in	91
8.8.2	Saving the presets	92
8.8.3	Automation under Pro Tools	92
8.9	Using in Logic, Mac OS X (AU)	92
8.10	Using in Ableton Live (AU and VST)	93
<b>ARP2600V END USER LICENSE AGREEMENT</b>		<b>95</b>

# 1 INTRODUCTION

## 1.1 The birth of ARP Instruments and the ARP2600

Alan R. Pearlman, whose initials would form the name of ARP Instruments, became interested in instruments for electronic music as early as 1948, when he was a student at the Worcester Polytechnic Institute. This was a means for him to associate his two passions: electronic music and the piano.

It was by commercializing the amplifier models for the NASA Gemini and Apollo programs that he would start his career. Around 1968 he started seriously imagining the possibility of building electronic instruments – after hearing a recording of “Switched-on Bach,” according to legend.

In 1969, Alan R. Pearlman, David Friend and Lewis G. Pollock created ARP Instruments (originally called Tonus Inc.). The company, based in Newton Highlands (Massachusetts, USA), conceived electronic products, but also and above all else a large modular synthesizer, the ARP 2500. The machine used a matrix which connected the different sections of the synthesizer, instead of the traditional cables found in its competitor’s modular system. The ARP 2500 found success in American universities.

The growth of ARP instruments was fast and in 1972 the ARP 2600, probably the most legendary of the entire range, was unveiled. This semi-modular synthesizer, conceived with an educational goal, was to become hugely successful after a shaky start. The ARP 2600 was notably used by Stevie Wonder, Joe Zawinul (Weather Report), Tony Banks (Genesis), Jean-Michel Jarre, Herbie Hancock... ARP was the market leader in synthesizers during the 70’s with around 40% of the market share.

In ten years, three versions of the ARP 2600 were commercialized: The first version was called “Blue meanie” because of its steely blue finish. The “blue meanie” was quickly replaced by a second version, with a grey background finish and white silk screening (1972). This was to be more popular. In 1978 ARP decided to change the graphic chart for all of its machines: a black background color with orange silk screening was introduced. The ARP2600 benefited from its third and last version.

The great rival of ARP was the Bob Moog’s company. The competition between the two manufacturers can easily be seen when we observe the machines: The ARP, for example, has linear potentiometers, while its competitor has rotating pitch bend and modulation wheels.

A well known episode of this competition was the 24 dB/octave filter, the 4012, used by the ARP. This was a replica of the famous filter made by its competitor. In 1973, this one threatened ARP with legal action and the firm decided to change the circuits on its filter. The 4072 was born and took the place of the 4012. This possessed a calibration error in the high frequencies – the maximum cut-off frequency was less than 11 kHz instead of the 16 kHz promised in the press. Luckily the repair for users was fast and not much of a burden. On the first ARP 2600’s, the 4012 filter was still used (this was the case for the “Blue meanie” and on the first examples of the “grey and white”) while the models that followed offered the 4072.

The ARP synthesizers possess very stable oscillators, more reliable than the ones equipping Bob Moog’s synthesizers, what he admitted himself. On the other hand, ARP for a long time dipped the electronic circuits for filtering in resin to avoid industrial piracy... this made for major problems when trying to perform a repair.

In 1972, ARP launched the Odyssey, which would be in direct competition with the Bob Moog’s monosynth released one year earlier. The same year, the Pro-Soloist, a preset instrument, was also unveiled.

In 1976, ARP released a small 16 step sequencer in the form of 2 independent 8 step sequences. This became famous and is still very sought after (it is emulated in the ARP2600 V.) The same year they presented the Omni, which would become one of ARPs biggest successes. The instrument allowed the combination of two polyphonic violin sounds – a great innovation for the company – and 2 monophonic bass sounds.

In 1976, ARP released a small 16-step sequencer in the form of two independent 8-step sequences. This became famous and is still very sought after (it is emulated in the ARP2600 V.) The same year they presented the Omni, which would become one of ARPs biggest successes. The instrument allowed the combination of two polyphonic violin sounds – a great innovation for the company – and two monophonic bass sounds.

But in 1981, ARP was finally bought out by CBS. The following year, CBS with part of the ARP development team would produce the Chroma, a programmable polyphonic synthesizer, and in 1984 the Chroma Polaris, a simplified and MIDI-capable version of the Chroma.

## 1.2 A better emulation thanks to TAE®

TAE® - True Analog Emulation - is a new technology dedicated to the digital reproduction of analog circuits used in vintage synthesizers.

When implemented in software code, TAE's algorithms guarantee authentic emulation of hardware specifications. This is why your ARP2600 V offers an unparalleled quality of sound.

In detail, TAE® combines four major advances in the domain of synthesis:

### 1.2.1 Aliasing-free oscillators

Standard digital synthesizers produce aliasing in high frequencies, and also when using Pulse Width Modulation or FM.

TAE® allows the production of totally aliasing-free oscillators in all contexts (PWM, FM...), and at no extra CPU cost.

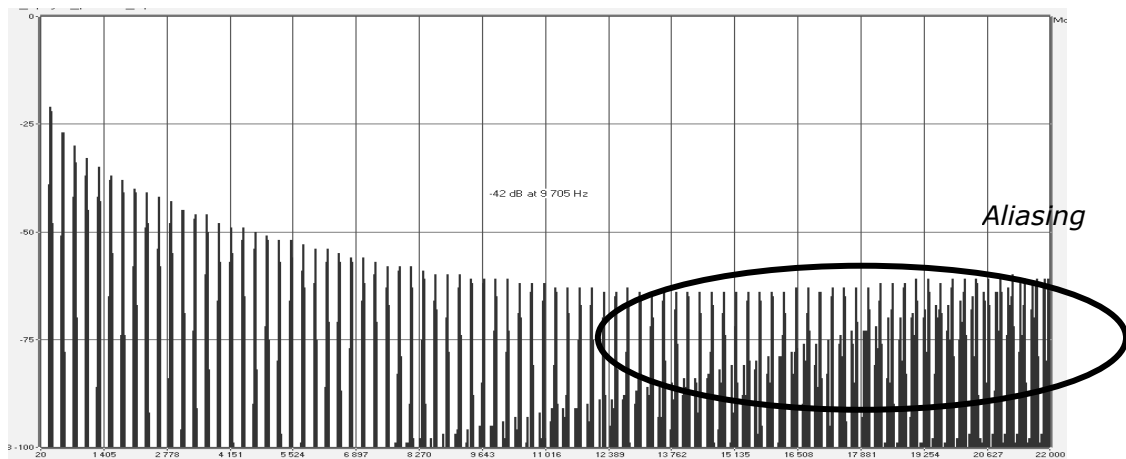

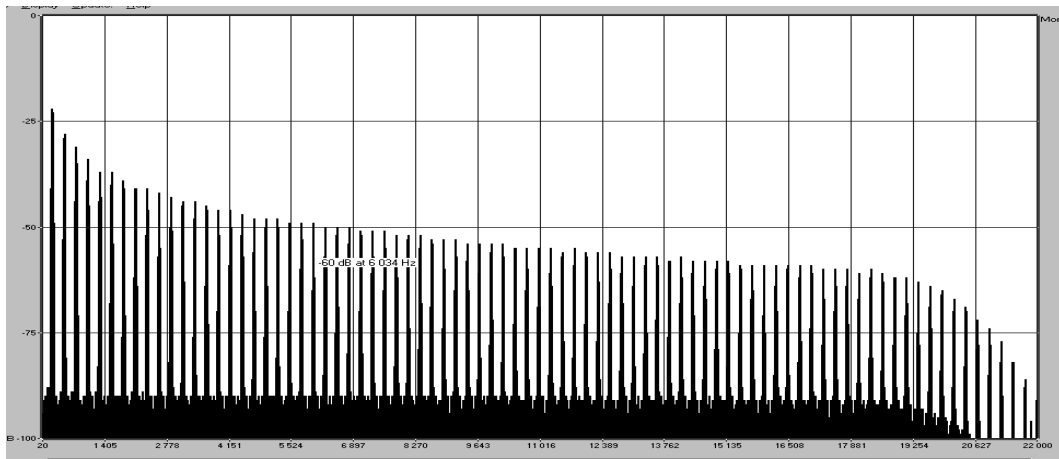

*Linear frequency spectrum of the ARP2600 V oscillator made with TAE*

### 1.2.2 A better reproduction of analog oscillator waveforms

The waveforms produced by the oscillators in analog synthesizers are marked by the presence of a capacitor in the circuits. The discharge of the capacitor results in a light bend in the original waveform (notably for saw tooth, triangular and square waveforms). TAE allows the reproduction of this capacitor discharge. Underneath is the analysis of a waveform from the original ARP2600, and that of the ARP2600 V. They are both equally deformed by the ARP2600 V low-pass and high-pass filtering.

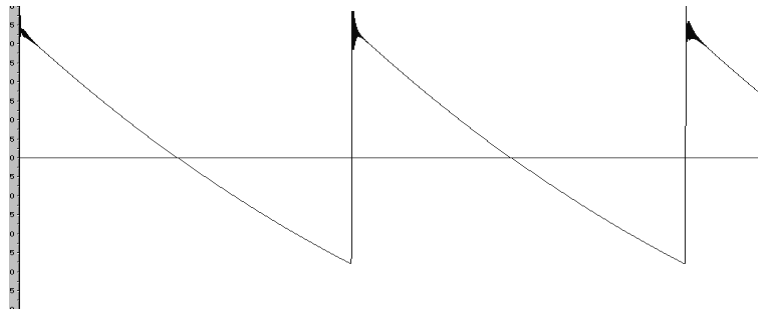

*Temporal representation of a "saw tooth" waveform of the original ARP2600*

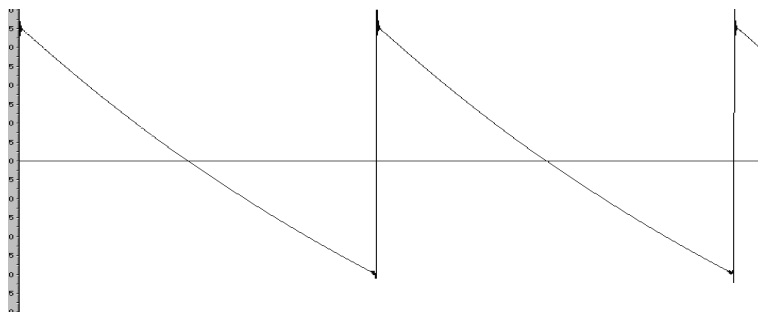

*Temporal representation of an ARP2600 V "saw tooth" waveform reproduced by TAE*

What's more, the original analog oscillators were unstable. In fact, their waveform varied slightly from one period to another. If we add to this the fact that the starting point for each period (in Trigger mode) can vary with the temperature and other environmental conditions,

we find one of the characteristics that contributed to the typical sound of vintage synthesizers.

TAE reproduces the instability of oscillators, bringing a fatter and “bigger” sound.

### 1.2.3 A better reproduction of analog filters

TAE allows more precise emulation of analog filters than standard digital filters. To obtain this result, the TAE technology is based on the analysis of the analog circuits to be reproduced, and converts them into algorithms that faithfully mimic the characteristics of the original filters. The curve underneath shows the comparison of the original ARP2600 filter and that of the ARP2600 V.

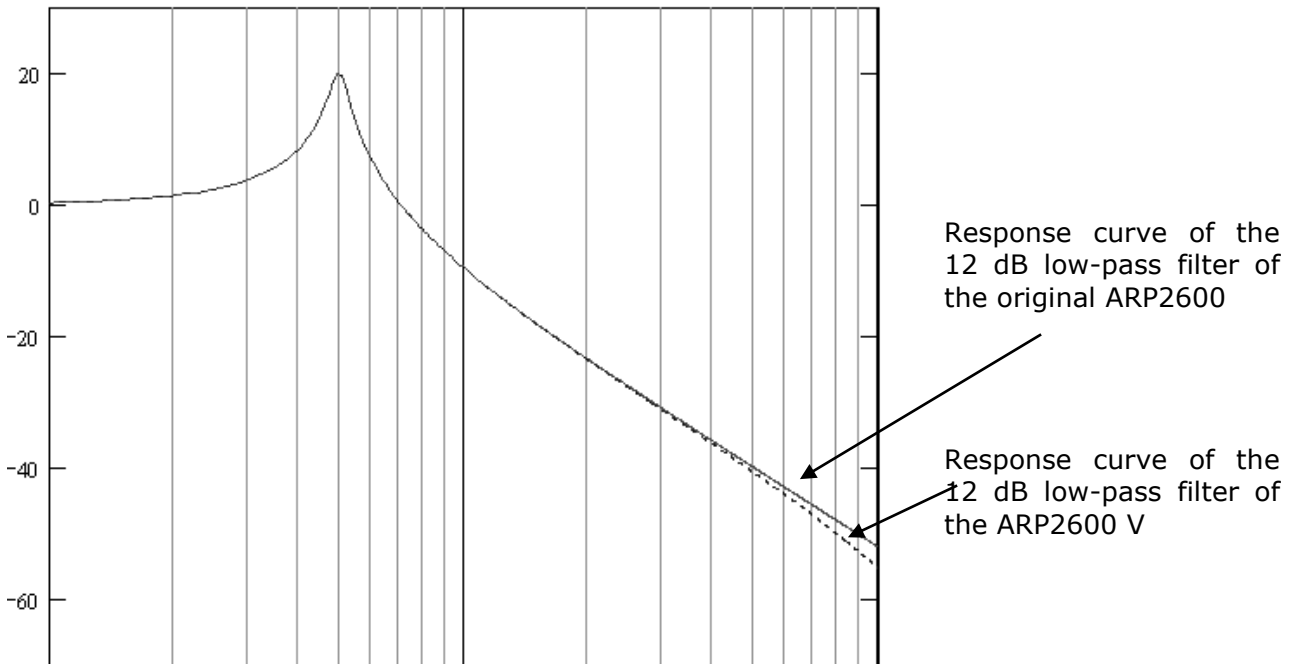

*Response curve of the 12 dB low-pass filter of the original ARP2600 and the ARP2600 V*

### 1.2.4 Ring modulator

The ARP2600 V includes a ring modulator, just like the original ARP2600. The ring modulator allows the application of a waveform (a sinusoid) to another, in order to transform it. The result is a more brilliant sound, distorted, and enriched in harmonics. As a result of this increase in the number of harmonics, standard ring modulation algorithms create an audible aliasing. To avoid this unwanted effect, TAE includes a module for the dynamic control of the amplitude with aliasing correction, which removes every trace of aliasing in the signal coming from the ring modulator.

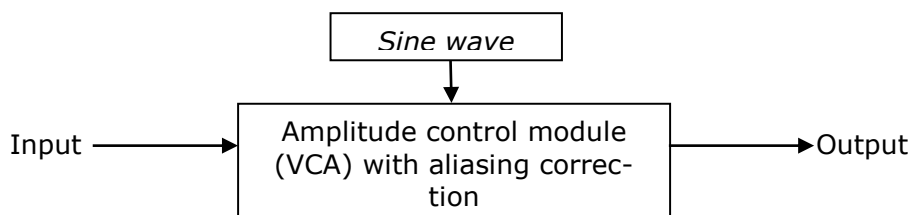



## 2 ACTIVATION & FIRST START

**ARP 2600 V** works on computers equipped with Windows 7 or 8 and Mac OS X 10.7 or later. You can use the stand-alone version or use **ARP 2600 V** as an Audio Units, AAX, VST2 or VST3 instrument.



### 2.1 Register & Activate

---

Once the ARP 2600 V has been installed, the next step is to register the software.

The registration process will require you to enter the serial number and the unlock code you received with the product.

In order to proceed, go to this web page and follow the instructions:

<http://www.arturia.com/register>

Note: If you don't have an Arturia account yet, you will need to create one. The process is quick, but it does require that you can access your e-mail address during the registration process.

Once you have acquired an Arturia account you will be able to register the product.

## 3 QUICK START

This chapter will help you to familiarize yourself with the general basics of using the ARP2600 V. A summary of the different parts of the synthesizer will be presented to you as we guide you through your first use of the program. You will find a detailed and precise description of all settings and controllers in the following chapters.

Chapter 7, *A few elements of sound design*, is highly recommended for users who have never worked with a subtractive synthesizer and who wish to become familiar with the fundamentals in this domain.



Overview of the ARP 2600V

### 3.1 Using presets

The use of presets is one of the biggest improvements of the ARP2600 V compared to the original. In fact, the latter was unable to save sounds!

In the ARP2600 V, a preset contains all of the parameter settings of the synthesizer, including the synthesizer and different real-time controllers (eg: velocity, aftertouch, pitch-bend) as well as the effects (delay, chorus) needed to reproduce a sound.

To get to know the different sounds contained in the ARP2600 V, we will use the preset "Bass1" situated in the "JMBlanchet" / "Basses" bank.

- ▶ For this, click on the button above the "BANK" LCD display indicating "Factory" (this screen presents the name of the current bank). By clicking here you will see a menu appear containing the list of available banks. Choose the bank "JM\_Blanchet" (the bank name is checked) .

When this menu is open, sub menus can be accessed (in the fashion of a drop-down menu). This system lets us access the "SUB BANK" and "PRESETS" for a sound designer with a single click.

- ▶ Choose the "SUB BANK" "Basses" and select "JMB\_Simple1" among the "PRESETS".

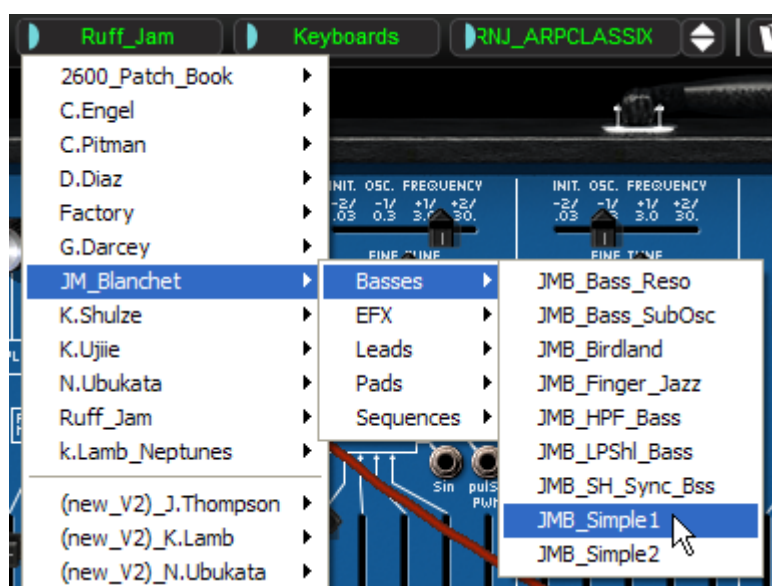

Select the preset JMB\_Simple1

The ARP2600 V ships with more than 400 presets that will help you to get to know the sounds of the synthesizer. A bank named "Templates" offers a selection of template presets for beginning the programming of a sound (the sound "1\_Osc", for example, comes with: an oscillator directed to the low-pass filter, and then routed towards the VCA).

It is also possible to visualize the entirety of the presets corresponding to a type of sub bank by selecting the option "All" in the bank. For example, to see all of the bass presets, click on "All" in the bank selection and then on "Bass".

### 3.1.1 Now modify a preset

For this, we will start with a very simple manipulation.

- ▶ Modify the brightness of the sound "JMB\_Simple1" with the linear "Initial Cutoff Frequency" potentiometer of the filter. Raise or lower the potentiometer and notice the sound become more or less "bright". Set this potentiometer to a pleasing value.

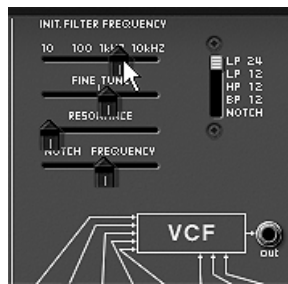

*Change the brightness of the sound*

- ▶ In the same manner, you can change the range of oscillator 1 by setting the “Range” selector to one of the values expressed in steps: LF = low frequencies, 32’ = -2 octaves, 16’ = -1 octave, 8’ = standard tuning, and 4’ = + 1 octave.



*Setting the range of oscillator1*

By performing these first settings, you have already modified the preset “JMB\_Simple1”. You will now see how to save the sound that you have created.

- ▶ To choose another destination for the sound, click on the “Save as” icon and choose the location. For example select “new” in the choice of bank. Two new banks, sub banks and a preset are immediately created. The names “new bank”, “new sub bank...” and “new preset...” appear in their respective displays.
- ▶ Click on each of these displays to rename the 3 parts.

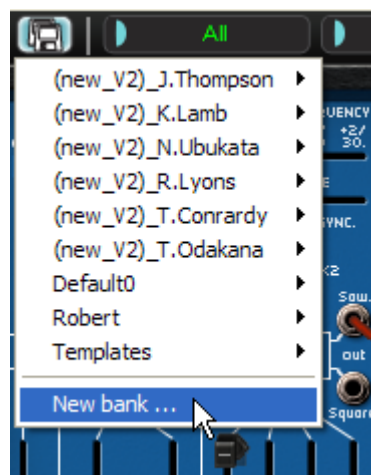

*Saving a preset*

To save a user preset (“**Users**”), click on the “Save” icon in the toolbar: The new settings will be saved in the current preset without changing the name (but if the selected preset is one of the “factory” presets, the factory setting will not be overwritten).

⚠ It is important to specify that changing the name of a preset does not create a new one! Only the name of the current preset will be changed.

### 3.2 The 3 sections of the ARP2600 V

The ARP 2600V offers three main sections separated into flight cases:

From top to bottom:

The synthesizer, the sequencer / LFO / general settings, and keyboard

To access the different parts of the ARP2600 there are two simple methods:

- ▶ Click on a part of the synthesizer that does not have any controllers (potentiometers, switches..) or jacks, then slide the mouse towards the top or the bottom without releasing.



*Slide the mouse towards the top or bottom*

Click on one of the three shortcuts **UP**, **BOTTOM** and **ALL** situated on the toolbar to quickly move from one section to another:

- The **UP** (SYNTHESIZER) section brings you to the synthesizer.
- The **BOTTOM** (SEQUENCER and KEYBOARD) section brings you to the sequencer.
- The **ALL** ("ALL") section brings you all the interface of the ARP2600 V

If you are in the "All" section, you can resize the window by clicking on the 2 arrows situated on the right of the 3 sections shortcuts.

### 3.3 Overview of the Synthesizer

The "SYNTH" section contains 73 synthesis parameters as well as jack inputs and outputs that you can connect to one another with virtual cables. The potentiometers or switches associated to these parameters will help you to create an infinite variety of sounds.

These parameters are made up of:

- Three oscillators (VCO) which release the audio signal through waveforms (triangle, sinusoid, saw-tooth, square and rectangle) and which manage the pitch (frequency) of the sound.
- A noise module.
- A ring modulator
- A sample / hold module.
- A mixer acting on the signals coming from the oscillators, noise module and ring modulator.
- A low-pass resonant 24 dB filter and multimode 12 dB (LP, HP, BP and notch)
- An amplifier (VCA) allowing the amplification of the signal coming from the filter and its direction towards the stereo output.
- Two envelopes (ADSR and AR) modulating the low-pass filters and amplifier.

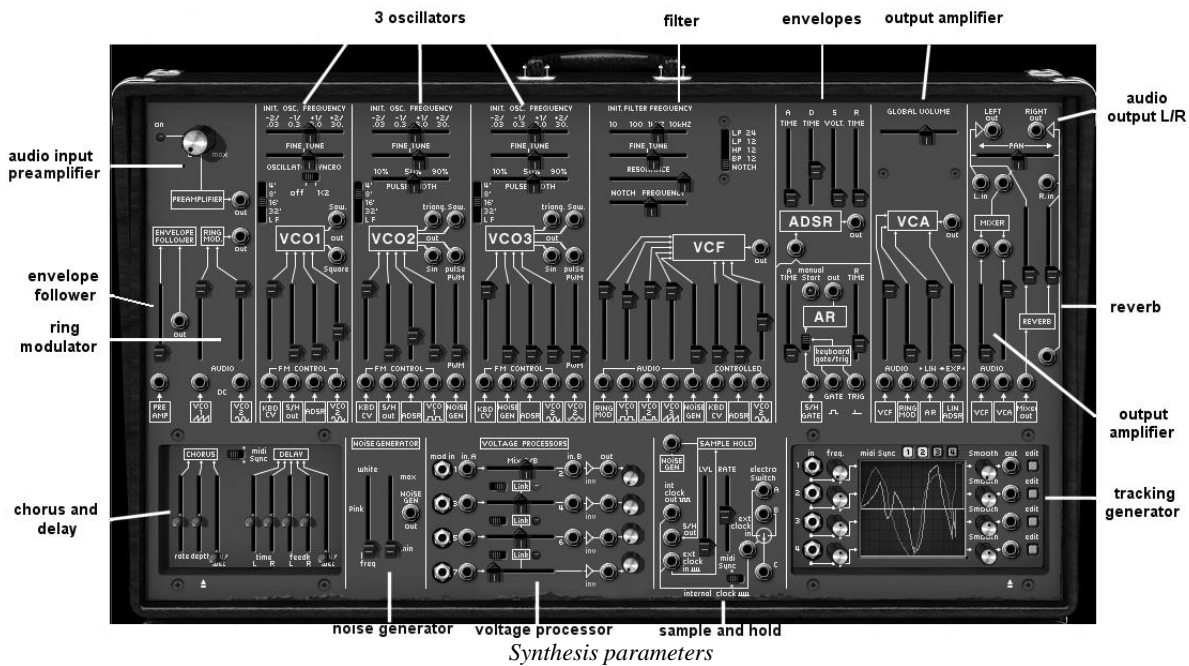

Let's look at quickly creating an evolving lead sound:

- ▶ To really understand the programming of the ARP2600 V, let's use a very simple sound. Select the preset "1\_Osc" in the "Template / Temp\_Synth" sub bank. The structure of synthesis for this sound is relatively simple: the square waveform oscillator1 is active and the signal is directed through the low-pass filter after an intermediary mixer, and then on to the output amplifier. An ADSR envelope modulates the filter cut-off frequency and a second envelope, AR, modulates the volume of the amplifier.

The following block diagram recaps the architecture of the creation of the sound:

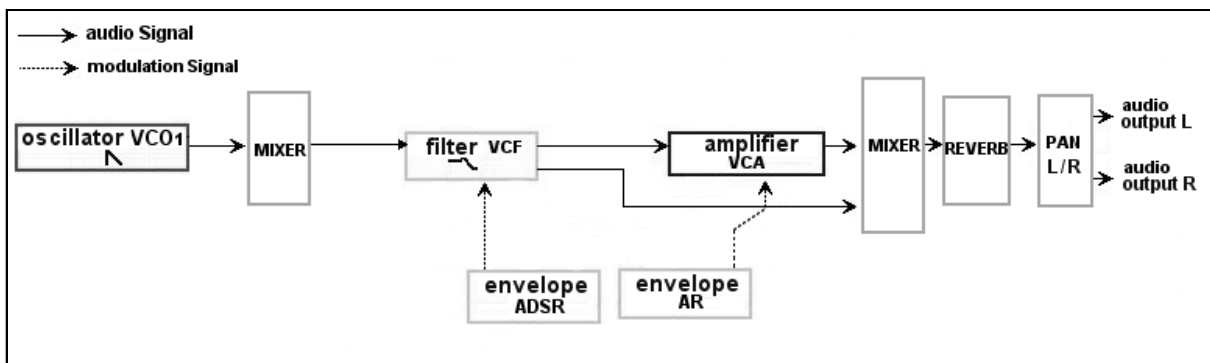

*The routing taken by the sound of preset "1\_Osc"*

- ▶ Start by reducing the low-pass filter cut-off frequency (LPF). This will dampen the sound. For this, set the linear "Initial Cutoff frequency" potentiometer (for fine tuning, use the "Fine tune" potentiometer). Notice that the filter cut-off frequency is modulated by an ADSR envelope (Attack, Decay, hold - Sustain - and Release).

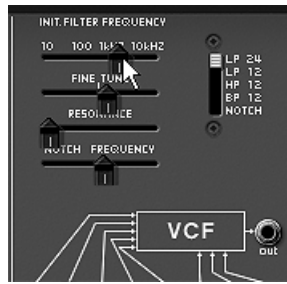

*Change the brightness of the sound*

- ▶ To clearly hear the effect produced by the ADSR envelope on the filter cut-off frequency, increase the resonance value. This will amplify the filtering effect on the sound and it will begin to “whistle”.

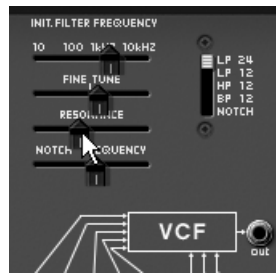

*Increase the resonance value*

- ▶ Change the attack length of this envelope (“Attack time”) so that the brightness increases faster or slower when the note is sent.



*Change the attack length of the ADSR envelope*

- ▶ In the same manner, change the value for the decay, and the brightness will increase faster or slower while you hold the note on the keyboard.



*The “Decay time” parameter on the filter envelope*

Now let’s perform a short modification on the second envelope, the “AR” envelope.

- ▶ Increase the “Attack time” for this envelope so that the volume of the sound progressively increases.



Increase the “Attack time” of the AR envelope

### 3.4 The sequencer

The “SEQ” section gives you access to the sequencer as well as different functions allowing an extension of the possibilities of synthesis and playing. It is situated under the “Synth” section. It contains a sequencer identical to the 16 step ARP (model 1601) sequencer, a module for play settings, and a low frequency oscillator (LFO) which was added as a complement to oscillator2 which was often used as LFO.

#### 3.4.1 The ARP sequencer

The ARP sequencer greatly increases the possibilities for sound and melodic creation. It allows you to create two simultaneous 8-step melodic lines, or one 16-step line (by putting two 8-step lines in a series). It is also possible to modulate any parameter of synthesis through one of the two sequencer outputs.

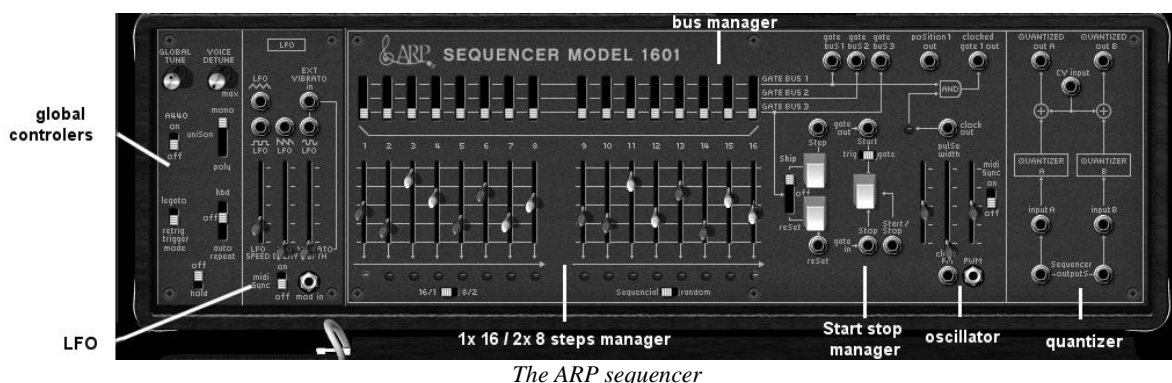

The ARP sequencer

The ARP sequencer contains 3 parts:

From left to right:

- The two lines of faders and selector switches situated at the top give access to the tuning of the 16 steps as well as management of their triggering (gates).



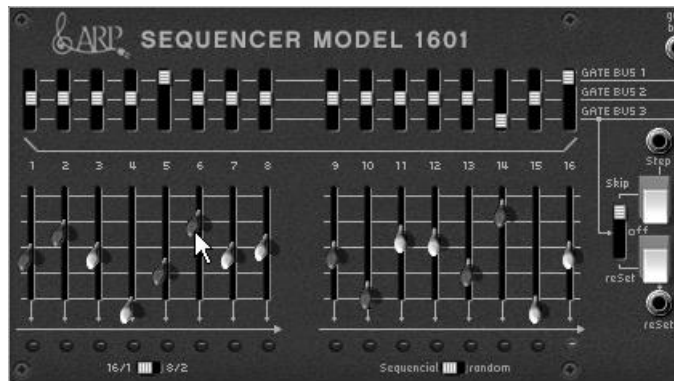

*The two lines of faders and selector switches*

- The oscillator sets the speed of the sequencer as well as the start and stop.



*Set the oscillator speed*

- The "Quantizer" quantifies the values for the 16 steps by semi-tone.



*The quantizer section*

Let's take a simple melodic sequence for example:

- ▶ Load the preset "Template"/ "Temp\_SEQ"/ "1x16\_sequencer"

You will notice that the connections between the sequencer and synthesizer are already done:

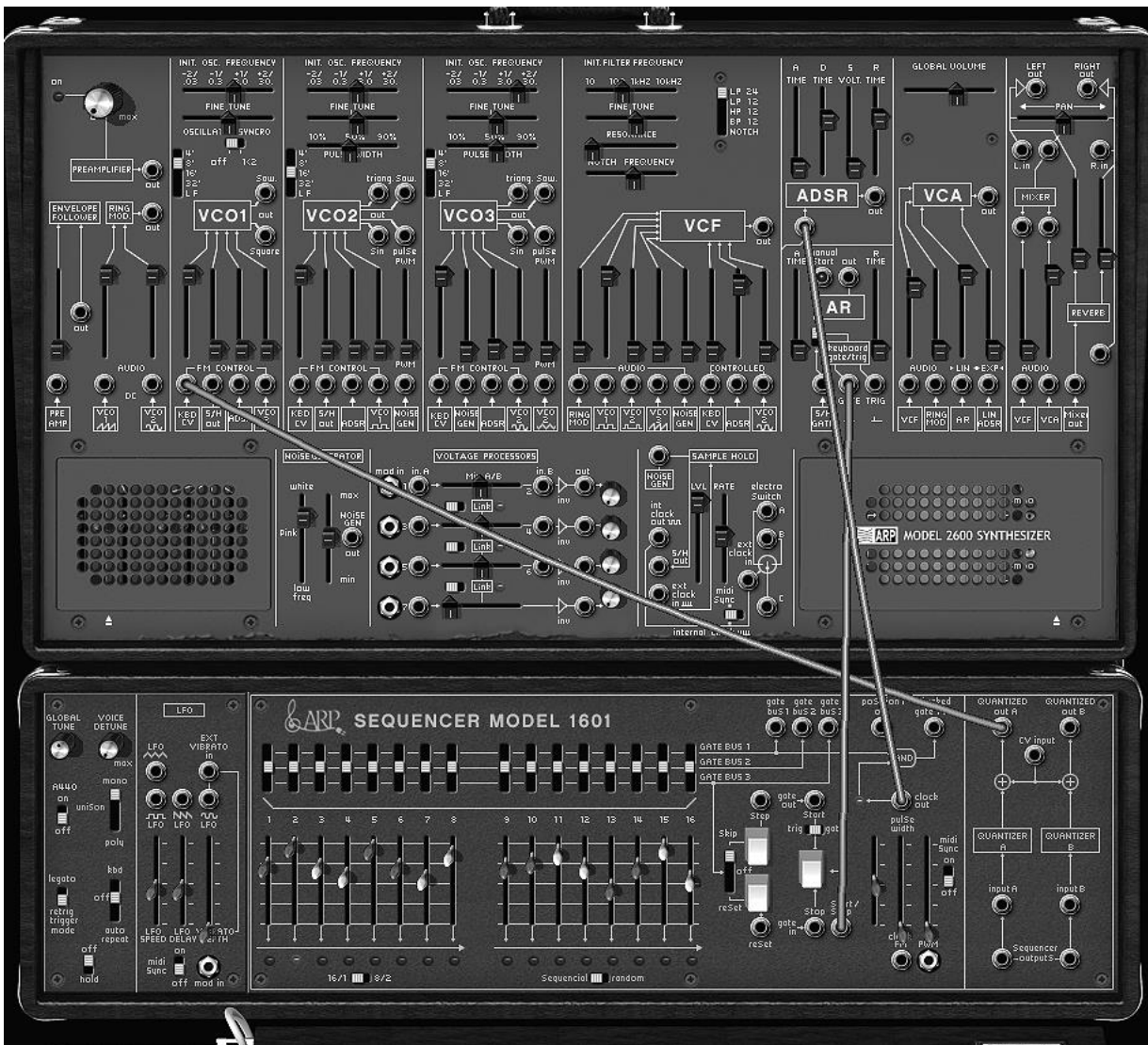

*The connections between the sequencer and synthesizer*

- ▶ The "Clock Out" sequencer output is directed to the "Gate" input on the ADSR envelope module.
- ▶ The sequencer "Quantized A Out" output is directed to input "KBD CV" of the "VCO 1" module.
- ▶ Start the sequencer by clicking on the "Start" button. This "turns" in a loop and you will hear the repetition of the melody.

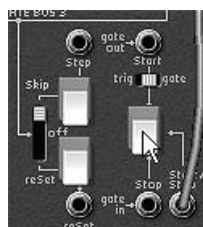

*Click on the "Start" button*

- ▶ You can change the settings of the 16 linear potentiometers to create an other melody.

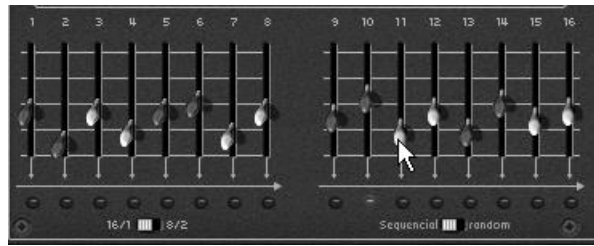

*Set the 16 linear potentiometers*

### 3.4.2 The LFO

On the original ARP 2600, oscillator2 could be set to low frequency position ("LF" position in the range) for use in LFO mode. Although practical, this solution prevented us from using 3 oscillators simultaneously and a slow modulation on the filter cut-off frequency for example.

Thanks to the LFO module situated on the "Keyboard control" module of the "All" mode, you can keep the third oscillator as base sound and obtain an additional source of modulation for one of the 13 available destinations. It is also possible to synchronize the clock speed of the LFO to that of the MIDI sequencer by clicking on the "MIDI sync" interrupter.

Apply two additional types of modulation to the preset "1\_Osc":

- ▶ For example: the LFO is "pre-cabled" to obtain a vibrato (simultaneous frequency modulation) of the two oscillators. Simply raise the linear potentiometer "Vibrato Depth", situated on the LFO module, to create this effect.



*Raise the "Vibrato Depth" potentiometer*

- ▶ Another example would be to click on the LFO triangle output and direct the cable to the "VCO2 sin" modulation input of the filter module. Raise the potentiometer above it. Lower the cut-off frequency to hear the result more clearly. The brightness of the sound will vary in a cyclic fashion, to the rhythm of the LFO.

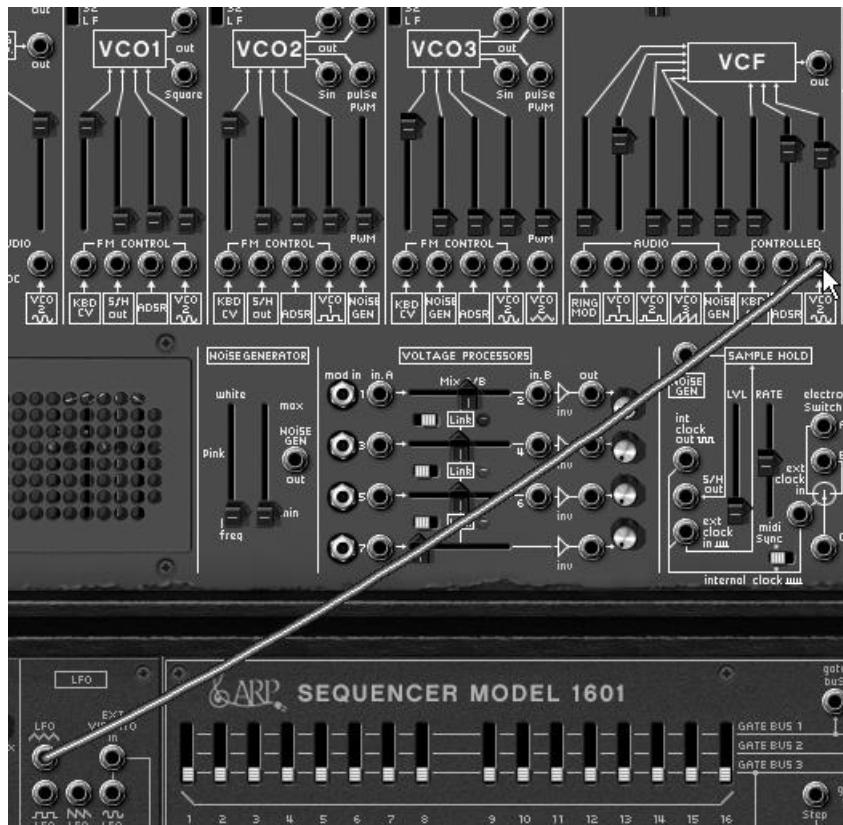

*Modulate the filter frequency ("Cutoff Frequency") with the LFO*

### 3.5 The effects

The effects section lets you add a Stereo Delay and Chorus to your sound on top of the reverberation which is already present in the original instrument. The two effects can be found in the place of the left speaker grid on the synthesizer.

To open it, click on the "open" button under this grid.

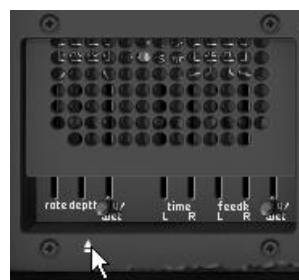

*Open the effects grid*

#### 3.5.1 Chorus

Chorus is used to copy your sound, and slightly detune the copy, to give it more depth and the Chorus "ON/OFF" button in the effects section, on the right of the toolbar.

- ▶ Set the Chorus "Dry/Wet" potentiometer to balance the "raw" sound and the one returning from the effect.
- ▶ Next turn the Chorus "Rate" potentiometer to set the speed of the oscillations.
- ▶ Finally set the depth of the chorus using the "Depth" potentiometer.



*The chorus effect settings*

### 3.5.2 Delay

Delay brings a stereo echo effect to bring more space to your sound.

It possesses independent settings for the speed and number of repetitions for the left and right sides. It is also possible to create a large number of rhythmic combinations between the repetitions. The delay speed can also be synchronized with the MIDI tempo.

Let's keep the preset "JMB\_Simple1" and see how to use the effects on this sound:

- ▶ Activate the "Delay" button on the toolbar. The effect becomes active.
- ▶ Set the Delay "Dry/Wet" potentiometer so as to balance the "raw" sound with the one coming from the delay.
- ▶ Next turn the two Delay "Speed" potentiometers to set the rate of echo repetitions for the right side (Time Right) and left side (Time Left).
- ▶ It is also possible to set the number of repetitions for each side ("Feedb. Right" and "Feedb. Left").

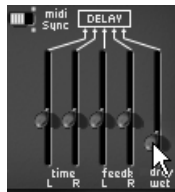

*The Delay effect settings*

### 3.6 Real-time controllers and MIDI assign

Like its brilliant ancestor, the ARP2600 V is particularly adapted to real-time playing. One of the main improvements when compared to the original is that we can assign any potentiometer on the ARP2600 V to an external MIDI controller.

For example:

- ▶ Click on "MIDI Learn" button of the toolbar
- ▶ Click on the "Initial Cutoff frequency" potentiometer of the filter. A MIDI assign dialog appears.
- ▶ Move the MIDI controller of your choice (the modulation wheel for example). The ARP2600 V potentiometer will start to move at the same time.
- ▶ You can then record movements from your MIDI controller on your MIDI sequencer or simply play live.

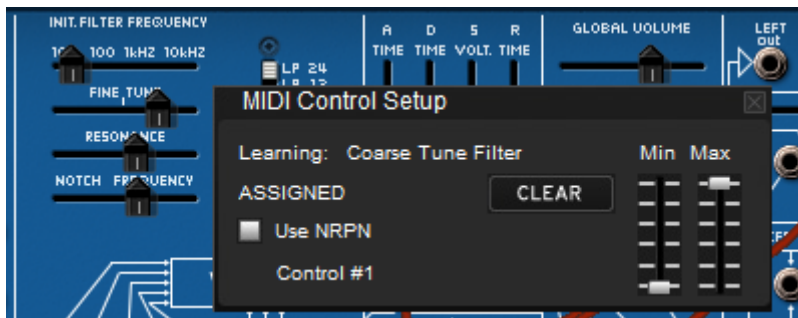

*MIDI assign for "Cutoff frequency" potentiometer*

To save the settings that we have seen in this chapter, click on the "Save" button in the toolbar.



## 4 THE INTERFACE

### 4.1 Using the presets

The presets memorize the ARP2600 V sounds. A preset contains all of the inter-module connections and the different controller information necessary for the recreation of an identical sound. In the ARP2600 V, presets are classed in "banks" and "sub-banks". Each bank contains a certain number of sub-banks, which determine a type of sound: sub-bank "basses", sub-bank "sound effects", etc. Each sub-bank contains a certain number of presets.

The ARP2600 V comes with several "factory" sound banks. It is possible to create new "user" sound banks, each containing an arbitrary number of sub-banks and presets. For security, the "factory" settings are not directly modifiable. It is, however, possible to modify a sound based on a factory preset and to record it to a "user" bank.

#### 4.1.1 Choice of bank, sub-bank, preset

The banks, sub-banks and presets being currently used are always displayed in the synthesizer toolbar.

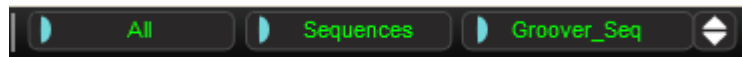

*Display of bank, sub-bank, and preset being used*

To choose a preset in the current sub-bank, click on the button on the left of the current preset, a drop-down menu appears with a list of presets from the same sub-bank. You can choose another preset in the menu by selecting the corresponding line. Once the preset has been chosen, you can play the new sound from your MIDI keyboard or sequencer.

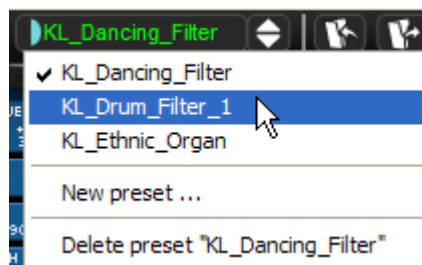

*Choice of preset in the same sub-bank*

To choose a preset in the same main bank, but in a different sub-bank, click on the button on the left of the current sub-bank, a drop-down menu will appear with the list of sub-banks contained in the same main bank. Each sub-bank in the menu allows you to open a sub-menu containing its presets. A click on a preset lets you directly choose a preset in the new sub-bank.

To choose a preset in another main bank, click on the button  next to the bank name. A drop-down menu appears with the choice of the main banks that are available, and the sub-lists corresponding to the sub-banks defined in each main bank and the presets contained in each sub-bank. You can now freely choose a preset by clicking on its name.

Once a preset has been changed (modification of a controller or connection), an asterisk appears next to its name in the tool bar.

In the “BANK” dropdown menu, the “All” option allows you to open a sub-list with all of the sub-banks available in all of the banks. This gives you access directly to all of the presets of a given type, for example all of the basses, no matter which bank they are in. This function is particularly useful to quickly see all of the presets of the same type.

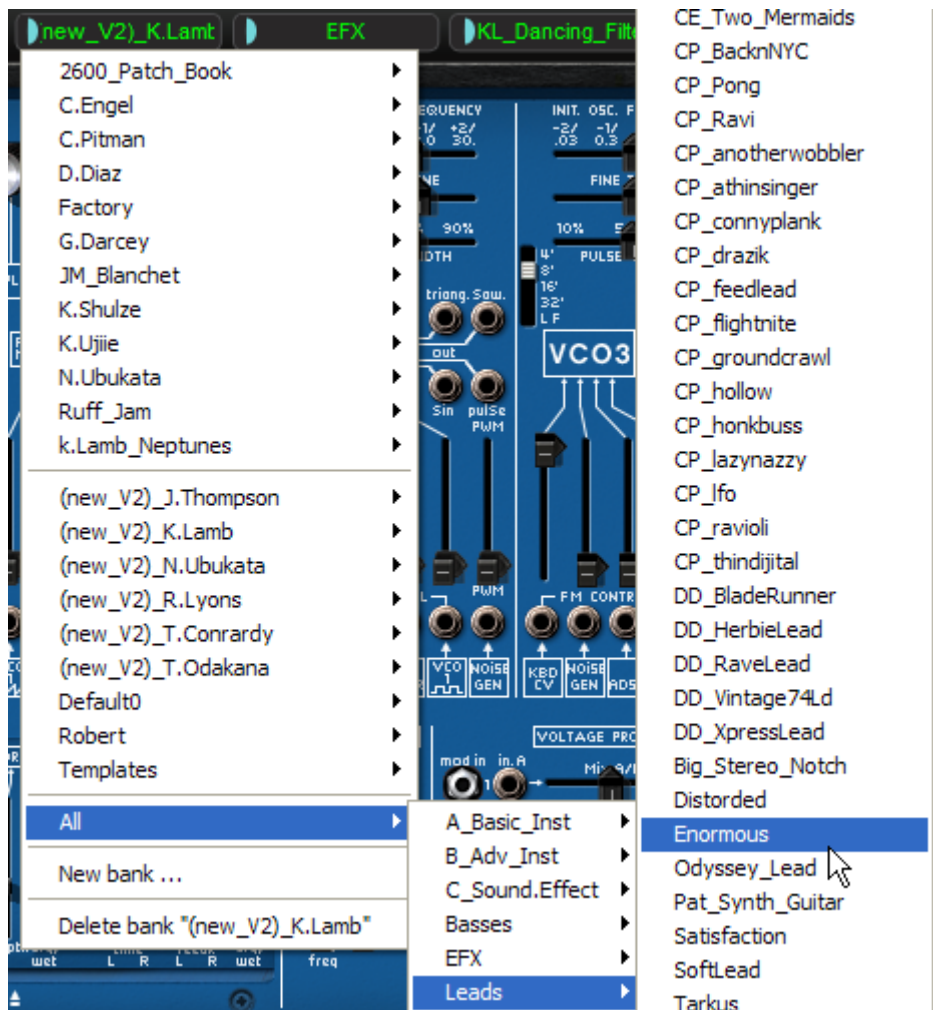

The “All” option

#### 4.1.2 Creation of a bank, sub-bank, preset

To create a new bank of sounds, click on the button on the left of the current bank. In the drop-down menu, select “New bank...” to create a new bank of sounds. You can then change the name of this bank by clicking on its name in the toolbar and typing the new name.

To create a new sub-bank, again just click on the button on the left of the current sub-bank, and select “New sub bank...”. You can also change the name of the new sub-bank.

Finally, to create a new preset, click on the button on the left of the name of the current preset and select “New preset...”. The new preset is created using the current ARP2600 V settings (controllers and connections). You can then work on the settings of the sound, and save it by clicking on the save button (see the next paragraph). You can also change the new preset name by clicking on its name.

#### 4.1.3 Saving a user preset

To save your current settings under the current preset, click on the “Save” button on the ARP2600 V toolbar.





*“Save” button on the toolbar*

If you want to save your preset under a different preset name, click on the “Save As” button in the toolbar. A drop-down menu will appear allowing the choice of either an existing preset (in this case, the preset contents will be replaced by the current setting), or to save your preset as a new preset (in this case, click on “New Preset...” in the sub-bank of your choice).



*“Save As” menu on the toolbar*

- ▶ When you are working on a factory preset, which cannot be erased, clicking on the “Save” button will not replace the current factory setting, but will automatically open the “Save As” function to save the current setting as a user preset. Click on the “New bank” option. The three LED displays indicate “New”: you can click on each of these displays to give it a name or save your setting as a new preset (in this case, click on “New preset...” in the sub-bank of your choice).

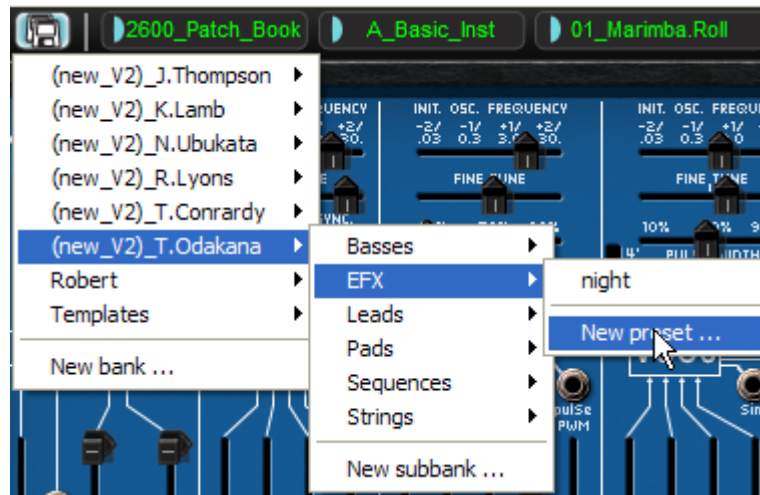

*The “New preset...” option*

#### **4.1.4 Importation / Exportation of a preset bank**

It is possible to import new preset banks created for the ARP2600 V. To import a new bank of presets, click on the preset bank import button in the toolbar:



*Preset bank import button on the toolbar*

When you click on this button, a dialog appears allowing the choice of ARP2600 V preset bank files (.AMB file type on PC, AMPB file type on Mac). Choose the file that you want to import, and click on “Open”. The new preset bank will automatically appear in the available banks.

The ARP2600 V also offers the option to export your own sound banks to save them, use them on another machine, or share them with other users. It is possible to export a preset, a sub-bank, or a complete bank. To export a bank, sub-bank, or current preset, click on the export preset bank button on the toolbar:



*Current preset bank export button in the toolbar*

Select the type of export that you wish to perform (bank, sub-bank or preset) from the list and a window will appear prompting you to choose a destination folder and a name for the file you are about to export.

## **4.2 Use of controllers**

### **4.2.1 Vertical linear potentiometers**

The ARP 2600V mainly uses linear potentiometers. To change the value of a vertical potentiometer, click on it and move it vertically to the desired value.



*Linear potentiometer*

### **4.2.2 Horizontal linear potentiometers**

To move these potentiometers, click on it and slide to the right or left to reach the desired value.



*Horizontal potentiometer*

### **4.2.3 Knobs**

You can find some knobs among the global settings, by exemple.

The default mode of control for knobs with the mouse is the linear mode: the knob can be set only by vertically moving the mouse. It is possible to obtain a higher precision by right clicking or Shift+Click on the concerned knob.



*Knob*

In circular mode, click on the knob and turn around it in order to change the value of the controller. The circular mode gives high precision in the manipulation of controls: The further the mouse goes from the knob, the higher the precision of the setting.

The linear mode is often more simple to use than rotation. But at the same time it can be less precise (the precision is limited by the number of vertical pixels on the screen from which the mouse movements are evaluated). It is possible to attain a higher level of precision by right-clicking, or shift-click, on the potentiometer you want to control.

#### 4.2.4 The selectors:

The selectors (the filter mode selector for example) are manipulated like vertical potentiometers by dragging with the mouse).



*The filter “Modes” selector*

#### 4.2.5 Switches

The ARP2600 V has several types of switches. Simply click on these switches to change their state.



*MIDI sync on/off switch*

#### 4.2.6 Pitch Bend

The pitch bend knob is used to change the pitch of the oscillators. Just click on the knob and move the mouse up or down to change the pitch of your sound. The knob goes back to the center position when the mouse is released.



*The pitch bend knob*

### 4.3 Using cables

The connection of different modules (Oscillators, Filter, VCA...) to one another broadens the possibilities for sound design. The ARP2600 V owes its extraordinary possibilities for creation in a large part to the wide range of connections possible. On the original ARP 2600, all of the connections were done by two types of cables:

#### 4.3.1 Audio and modulation connections

The *audio* connections can be used, for example, to route the audio output of a waveform from an oscillator to the audio input of the filter or VCA mixer. In the same manner, the *modulation* connections allow you to route the output of a LFO or envelope generator to an oscillator PWM or the VCA modulation input. These *audio* and *modulation* signals are perfectly compatible with each other, the only difference being that the *audio* signals are “audible” if you connect them directly to the VCA, while the *modulation* signals are generally not audible (as the frequency is too low for the human ear). *Modulation* signals are generally used to program “slow” variations on certain synthesis settings, like the filter cut-off frequency for example.

- The audio output and input connectors, and the modulation out connectors are represented differently in the graphical interface:



*Audio input connector*

- Additional modulation input connectors can be found on the tracking module located under the grid of the right loud speaker. They are graphically distinguished from the other connectors as they include an additional function: the modulation level setting, described later on in this chapter:



*Modulation input connector*

To connect the output of a module to the input of another module, click on the output and, while holding the mouse button depressed, drag the mouse to the input connector of the second module. When you pass over a connector on which the current cable can be placed, the connector will light up. In this case, when you release the mouse button, the connection will be created between the selected input and output.

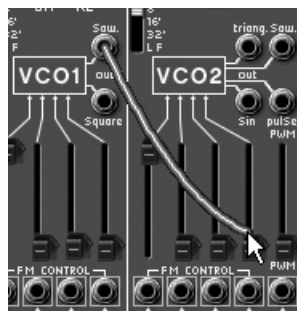

*Creation of a new connection by drag and drop*

Another way is to right click (on Mac: click while holding down the shift key) on the input or output of a module. In this case, a menu appears with a list of possible connection points for this input/output. It can happen that the input/output will already be connected to certain modules; in this case the connection points already in use will appear in this menu. Simply choose a connection point in the "Connect to" menu to create a connection. It is also possible to delete the current connection by choosing the "Remove connection" option.

Remark: Each modulation input can only receive one connection, but each output connector can be connected to any number of inputs. This allows us to use one modulation signal on several synthesis settings.

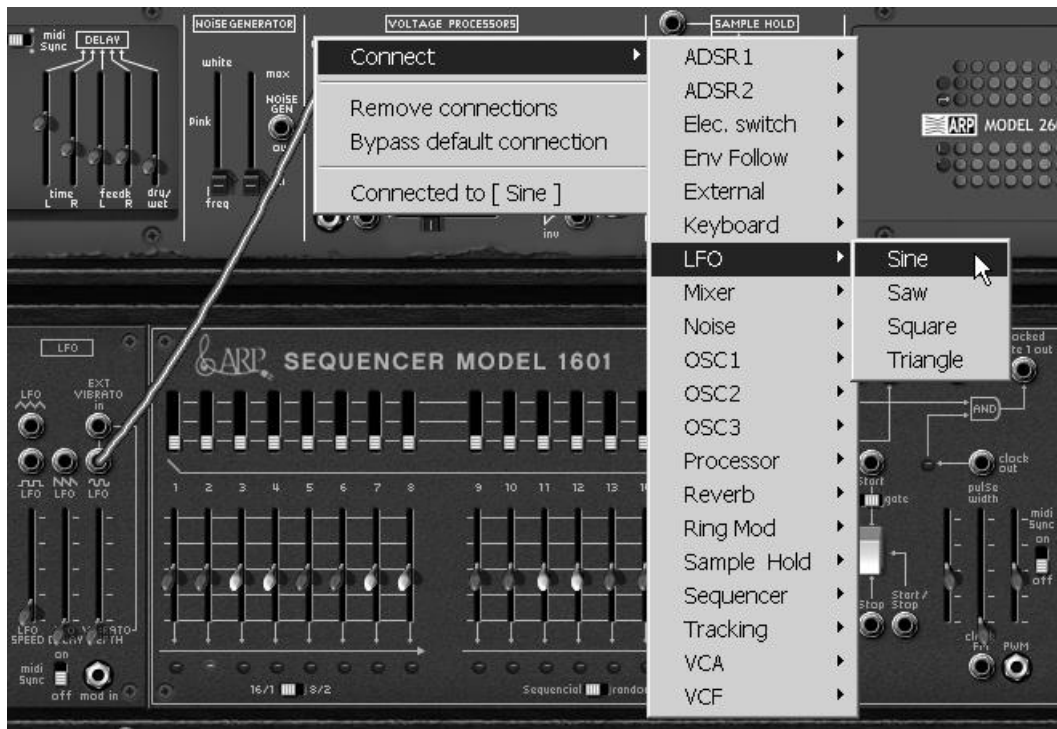

*Right click for input/output connection menu (or Shift + click)*

### 4.3.2 Modifying a connection

To disconnect a cable from an input connector, and reconnect it to another, click on the end of the cable and hold the mouse button down. You can now use the mouse to drag the cable to another input and release the button.

To delete a connection, you can right click and use the menu (or Shift + click). It is also possible to click on the cable to be removed to select it. The cable will appear in a lighter color to indicate that it is selected. Then simply press the "DEL" key to delete the connection.

Remark: You will have trouble selecting a cable if the "Move away cables" option is active! In this mode, the cables automatically avoid the mouse pointer. To avoid this, deactivate this option before trying to select a cable (see. 1.4.4.3)

### 4.3.3 Setting the level of modulation

As explained above, the modulation input connectors have an interesting property: they allow the setting of the level of modulation (from -100% to +100%) directly at connector level, and thus avoid the need to use a VCA which would normally be necessary to set the amplitude of the modulation signal. When the modulation input connector is connected, click on one of the edges of the jack's hex nut and drag the mouse up or down to change the depth of modulation:



*Setting the quantity of modulation*

By right clicking (or Shift + click) instead of the left click, you will obtain a more precise setting.

⚠ If you click on the centre of the connector, you will select the cable end to change the connection. To access the modulation setting, make sure you click on the nut. In the same way, if you right click (or Shift + click) on the centre of the connector, you will reach the connection menu instead of the precise modulation quantity setting.

#### 4.3.4 Separate the cables

Visualizing the existing connections between different modules is very useful when creating a patch on the ARP2600 V. At the same time, the cables can sometimes hide access to some of the settings available on the modules. So as not to be hindered in your manipulations, it can be useful to activate the “Move away cables” mode. In this mode, the cables will automatically avoid the mouse pointer, leaving you with a clearer view to checking or modifying potentiometer values. Don’t forget to deactivate this mode when you want to select a cable with the mouse!



*Deactivate the “separate the cables” mode*

#### 4.3.5 Virtual keyboard

The keyboard lets you listen to the synthesizer sounds without the need for an external master MIDI keyboard, and without programming a melody in the sequencer. Just click on a virtual key to hear the corresponding sound.

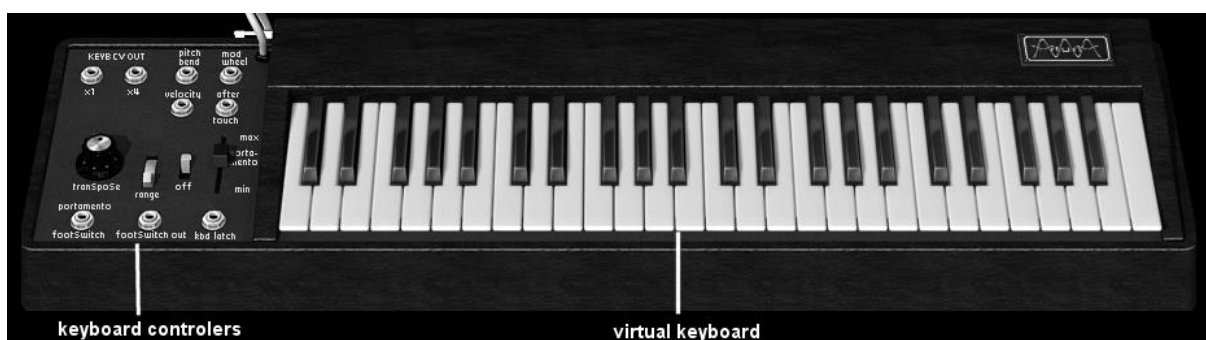

### 4.3.6 MIDI control

Most of the knobs, sliders and switches on the ARP2600 V can be manipulated with external MIDI controllers. Before anything else, make sure that the MIDI device that you wish to use is correctly connected to the computer, and that the sequencer or the ARP2600 V application is correctly configured to receive MIDI events coming from the device.

#### 4.3.6.1 Learn Menu

A new button and menu have been introduced in ARP2600 V. The button and menu provide access to MIDI assign functionalities.

The left part of the button activates the MIDI learn mode, while the right part (small down arrow) opens the control management menu.

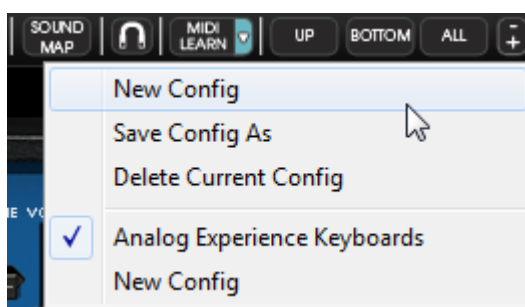

*“Learn” Menu*



*“Learn Mode” Button*

The “Learn” Menu is composed of 2 sections:

- First section provides:
  - “New Config” creates a new controller set
  - “Save Config As” saves current configuration to a new one
  - “Delete Current Config” removes current configuration from list
- The second section contains the list of existing configurations:
  - The checked one is the currently selected MIDI map
  - Click on a configuration to load it

#### 4.3.6.2 Assigning MIDI Controls

In order to start assigning MIDI controls, click the “Midi Learn” button (left part). The button remains highlighted to indicate that the “learn mode” is ON.

Click on a knob or button in the GUI to open the MIDI assignment popup.

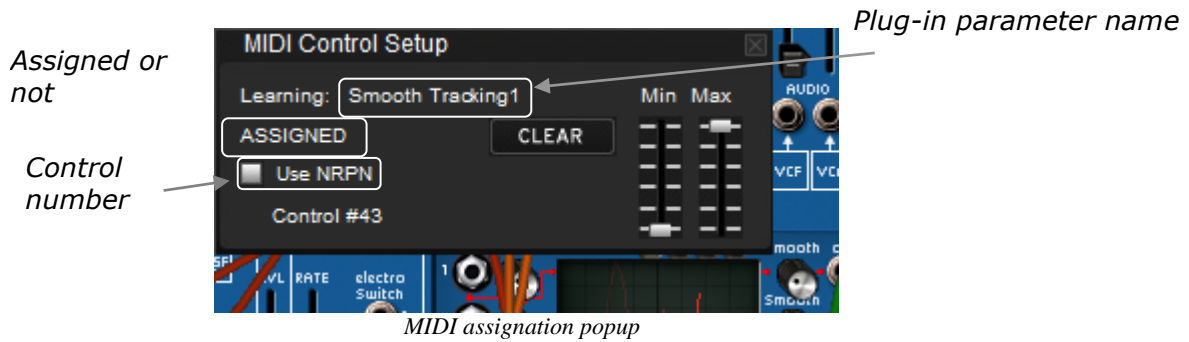

- Learn assignment

The fastest and easiest way to assign a control is to move the fader, knob or button for it to be recognized by ARP2600 V.

- Manual assignment

It is also possible to change the assigned MIDI control number by clicking on Control#xx and select a specific value.

- Support for NRPN

In addition to MIDI Control Change messages, NRPN messages are now supported: either send NRPN MIDI control messages to ARP2600 V, or check NRPN, then manually select LSB# and MSB# numbers:

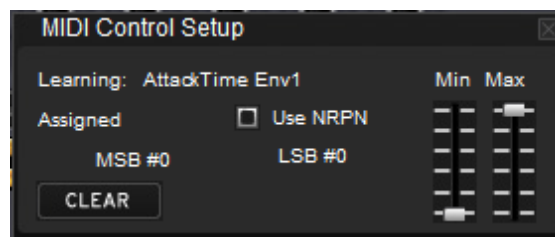

- Remove assignment

Assignments can be removed by clicking the "Clear" button. The message "Unassigned" will then be displayed.

Continue selecting the parameters you want to map to create a complete configuration.

#### 4.3.6.3 Manages Configurations

New in ARP2600 V: the possibility to maintain multiple configurations.

- Default configuration

By default, ARP2600 V loads the configuration for Arturia Analog Experience keyboards.

- Select one configuration

A configuration is loaded by clicking the corresponding entry in bottom part of "Learn menu".



- Create a new configuration

A new configuration can be created by clicking on the “Learn menu”, “New Config” entry. This will open a popup: enter the name you want to call your configuration and click on the “SAVE” button. A new entry for your configuration now exists in the list of available configurations.

You may now fill in this initially empty configuration by performing the assignment operations described in the previous section.

- Copy a configuration

It is possible to copy a configuration by loading it and then clicking on “Save Config As”.

A popup opens: enter the name of your configuration. A new entry for your configuration now exists in the list of available configurations.

- Remove a configuration

It is possible to remove a configuration by first loading it and then clicking on “Delete Current Config”.

#### 4.3.6.4 Minimum and Maximum Ranges

For each assignment, a minimum range value and a maximum range value can be set. This allows you to limit how much the controller will affect the parameter on ARP2600 V.

- The assigned parameter will have the configured minimum value when the controller will be at its lowest position
- The assigned parameter will only reach the configured maximum value when the controller will be at its highest position
- You can invert (Negative Slope) the Min and Max so that parameter will have minimum value when control has the highest value, and parameter will have maximum value when control has the lowest value

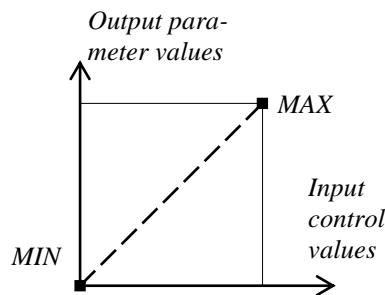

DEFAULT

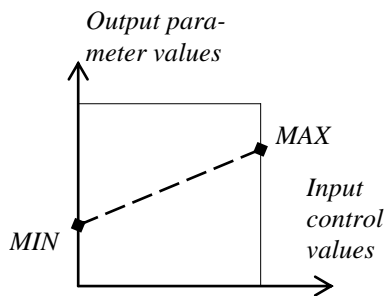

POSITIVE SLOPE

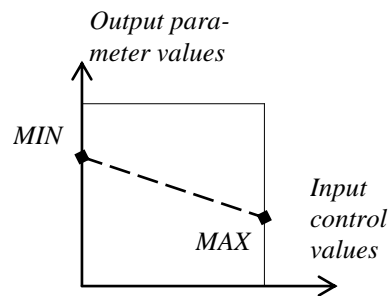

NEGATIVE SLOPE

$$\text{parameter\_value} = \text{MIN} + (\text{MAX} - \text{MIN}) * \text{control\_value}$$

#### 4.3.6.5 Multiple Assigned Parameters

It is possible to assign multiple parameters to a single control. This allows you to change many parameters with one fader or knob.

- Activate “Learn” mode, select a parameter (GUI control)
- Tweak control to assign it (optionally setup minimum and maximum)
- Select a second parameter
- And tweak the same control
- Deactivate “Learn” mode

Tweaking assigned control should modify both parameters with regards to assignation setup (Min, Max).

#### 4.3.6.6 Tricks

- The filter/amplifier envelope control points have two parameters: Level and Time. If “Learn” mode is ON, clicking on control point provides access to the assignment of the Level parameter, shift+clicking on control point provides access to assignment of the Time parameter.

## 4.4 The sound map

The sound map is an innovative preset explorer which offers an easy and funky way to locate and choose a preset on a map area to simplify the preset management and to quickly find the appropriate sounds.

The sound map also offers brand new interface for creating new sounds thanks to a morphing feature between four presets.

The Sound Map offers three views:

- The **MAP** main interface: the sound map classifies the presets thanks to statistic methods in order to organize the sounds on a map from their own audio characteristics.
  - The **LIST** presets list: this page offers a more classical interface to classify the presets using lists and filters to find the desired sound.
  - The **COMPASS** morphing interface: this page allows creating new sounds in real time thanks to a morphing result with up to 4 presets.
- ▶ To open the main Sound Map interface, click on the *SOUND MAP* button located on the tool bar. A new window appears over the ARP2600 V main interface.



*Open the main Sound Map interface*

- ▶ To open the preset list page, click on the *LIST* button, on the top right of the sound map interface



*Open the List interface*

- ▶ To open the preset morphing page, click on the *COMPASS* button.



*Open the Morphing interface*

- ▶ To return back on the main sound map interface, click on the *MAP* button



*Return back on the map interface*

#### 4.4.1 The MAP main interface

The sound map interface shows a map where are shared out all the presets of the ARP2600 V organized for their types of sound and their own audio characteristics.

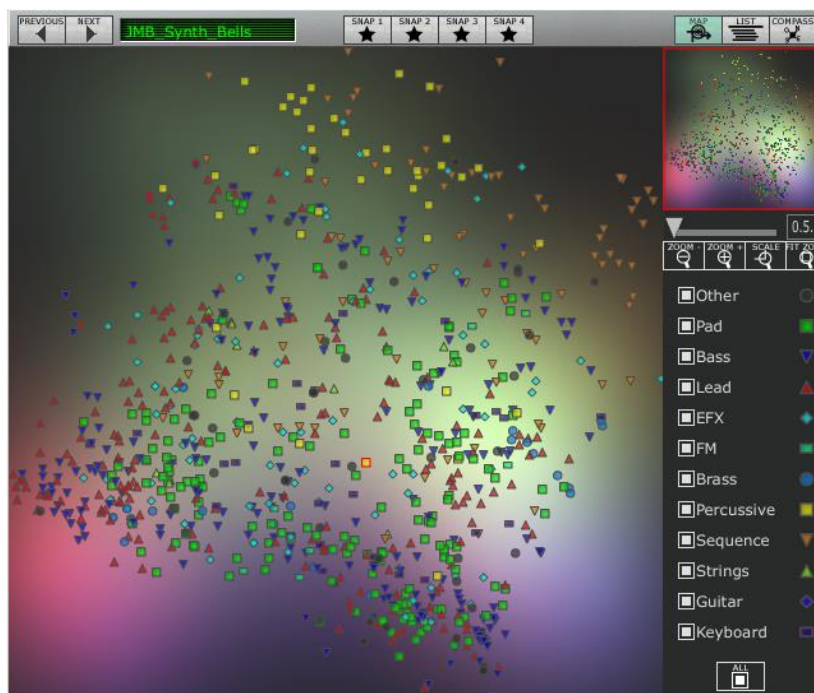

*The Map interface*

The types of presets are represented by different geometrical characters and colors for an easy way to locate them:

- ▼ "Bass" sounds
- "Brass" sounds
- ◆ "EFX" sounds
- "FM" sounds
- ◆ "Guitar" sounds
- "Keyboard" sounds
- ▲ "Lead" sounds
- "Pad" sounds
- "Percussive" sounds
- ▼ "Sequence" sounds
- ▲ "Strings" sounds
- "Others" sounds

- ▶ To select and to listen a preset, directly click on one of the icons, anywhere you want on the map area. The icon is now highlighted in red. If you hold a few seconds on the selected preset, a popup appears and indicates the name of the preset.

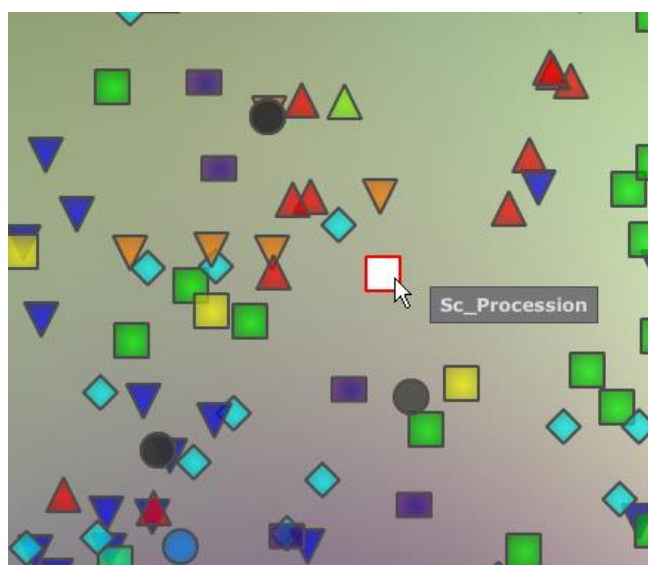

*Select a preset*

You can create new presets thanks to an exclusive real time morphing feature:

- ▶ Click between a group of presets and hold the left button of the mouse on this point. Four red arrows drawing a cross appear linking the group of four presets.

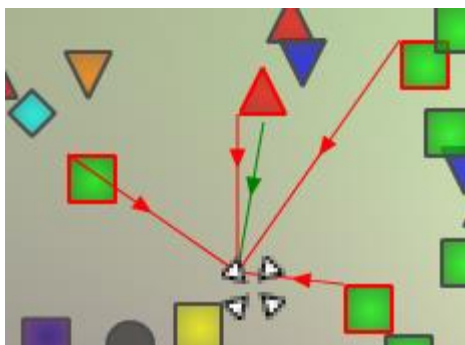

*Morphing between a group of presets*

- ▶ You can now drag your mouse between those presets. The green arrow shows you the starting point of your motion.
- ▶ When you release the left mouse button, you can play the resulted sound and, if you wish, you can save it on an ARP2600 V user bank.

By this way it is very easy to quickly get some new and exciting sounds without programming anything on the synthesizer interface.

#### 4.4.2 The Sound Map overview

On the top right of the Sound Map main interface, you can see an overview of this map.

You can use the map overview for navigating into the map and to zoom in or out inside of the map area.

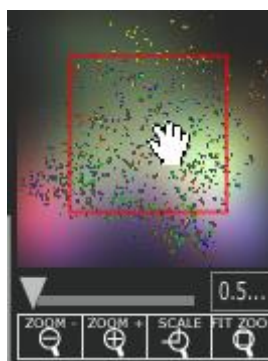

*The map overview interface*

- ▶ To navigate into the map, click inside of the red square and drag it on the map area to view other sections of the Sound map.
- ▶ To zoom in the view on the sound map, click on the *Zoom* slider, under the overview window, and drag it on the right to increase the size of the map.
- ▶ To zoom out the view on the sound map, click on the *Zoom* slider, and drag it on the left to decrease the size of the map.



*The zoom slider*

---

 You can also use the "ZOOM +" or "ZOOM -" buttons, under the slider, to increase or decrease the map size step by step (by factor 1).

---

- ▶ Click on the *FIT ZOOM* button allows resizing the map to its global size.



*The FIT ZOOM button*

#### 4.4.2.1 The instrument type filter window

On the right of the map main interface, an instrument type filter window allows you to choose which type of preset you want to see (or to hide) on the map. By default, all types of presets are selected.

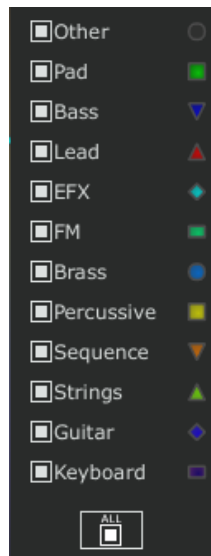

*The instrument type filter*

To select an individual or a group of instrument types:

- ▶ First click on the *All* button, on the bottom of the type filter window: this will hide all the instrument types from the sound map.



*The ALL button*

- ▶ Then, select the type(s) you want to see by clicking on the corresponding square box(es). A nock appears on the selected box(es) and the type(s) of presets appears on the map interface.



*Show pad presets*

This is a good way to simplify and to refine the preset search.

- ▶ If you click again on the *All* button, all types of presets will be displayed on the map.

#### 4.4.2.2 Preset snap shot memories

You can select up to four presets, anywhere on the map interface, and save them on up to four snap shot memories. You will be able to use those four presets on the *COMPASS* view to create new sounds by morphing feature (see below for more details on this feature).

Of course, you can save any kind of type of presets on these four snap memories.



*Select a snap memory*

To save a preset on a snap memory:

- ▶ Select a preset on the sound map main interface.
- ▶ Hold the [Shift] key and select one of the four snap memory button. The snap memory button is now highlighted in red.
- ▶ Repeat the same actions if you wish to save presets on the three other snap memories.
- ▶ When all memories already contain a saved preset, you can replace them with other presets.
- ▶ Select another preset anywhere on the Sound Map interface, click on any of the 4 snapshot buttons while pressing the [Ctrl] key.

### 4.4.3 The LIST preset manager

The list preset manager offers a more classical way to explore the presets using a list interface in which the presets are classified and filtered in order to simplify preset management.

- ▶ To open the list interface, click on the *LIST* button located on the toolbar of the Sound Map.



*Click on the LIST button*

The list preset interface is very simple, you can see four columns showing, from left to right:

- The preset names
- The instrument type
- The name of the sound designers
- A reminder of the presets added to a snap memory

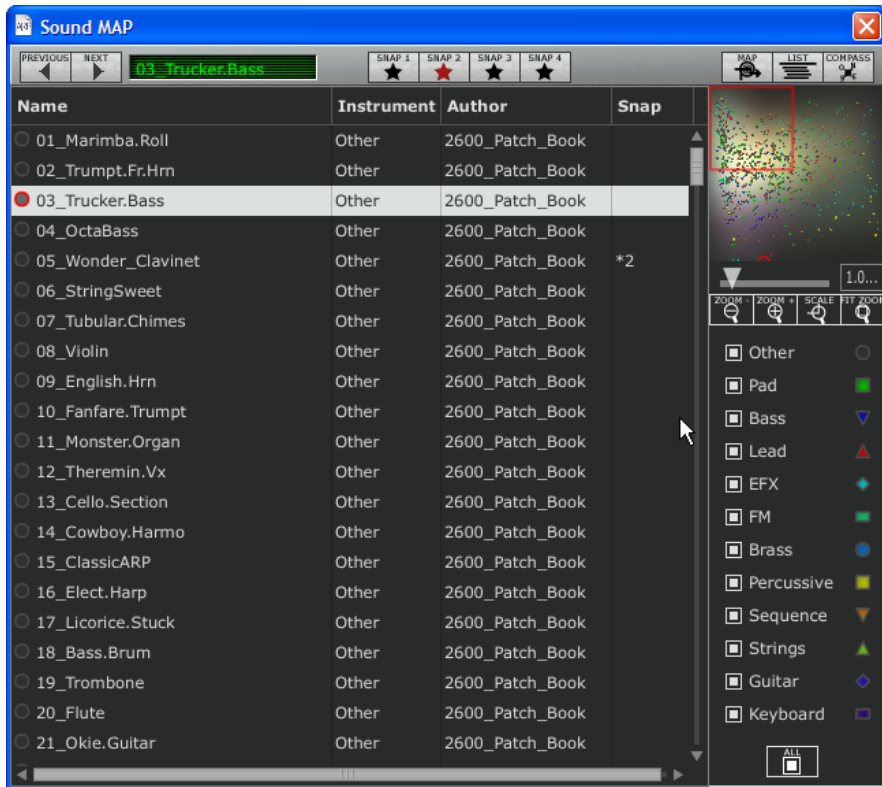

*Preset list interface*

All those data are classified by alphabetical order.

- ▶ To select a preset, simply browse the list and click on the name of a desired preset.
- ▶ You can inverse the order (from A to Z or from Z to A) by clicking on the column title: an ascendant or descendant arrow shows you the order type.

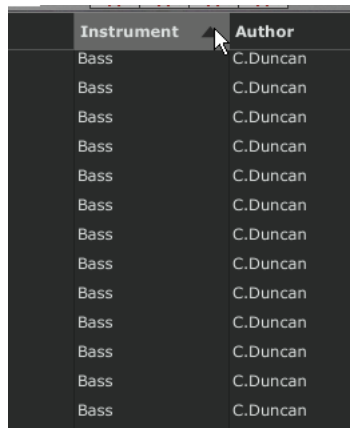

*Inverse the order of the instrument types*

#### 4.4.4 The COMPASS morphing interface

The Morphing page is an independent module allowing you to quickly create some new sounds thanks to a real time morphing from the four selected presets saved on the snap memories.

The four presets are placed on the four cardinal points of the compass.



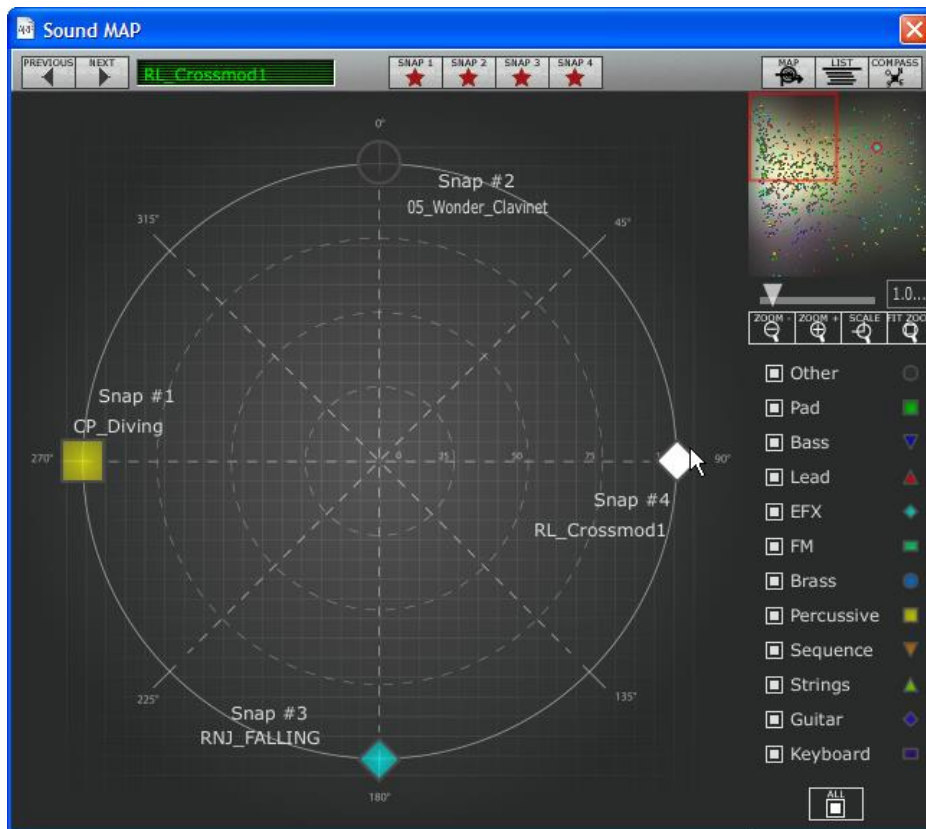

*The Morphing interface*

- ▶ To open the Morphing page, click on the *COMPASS* button, situated on the toolbar of the Sound map.

To create a new morphed sound from those presets:

- ▶ Click anywhere on the centre of the compass area (four red arrows appear converging to the group of presets)
- ▶ Hold the left button of your mouse and drag the convergence point until having the good sound. The green arrow shows you the starting point of your motion.

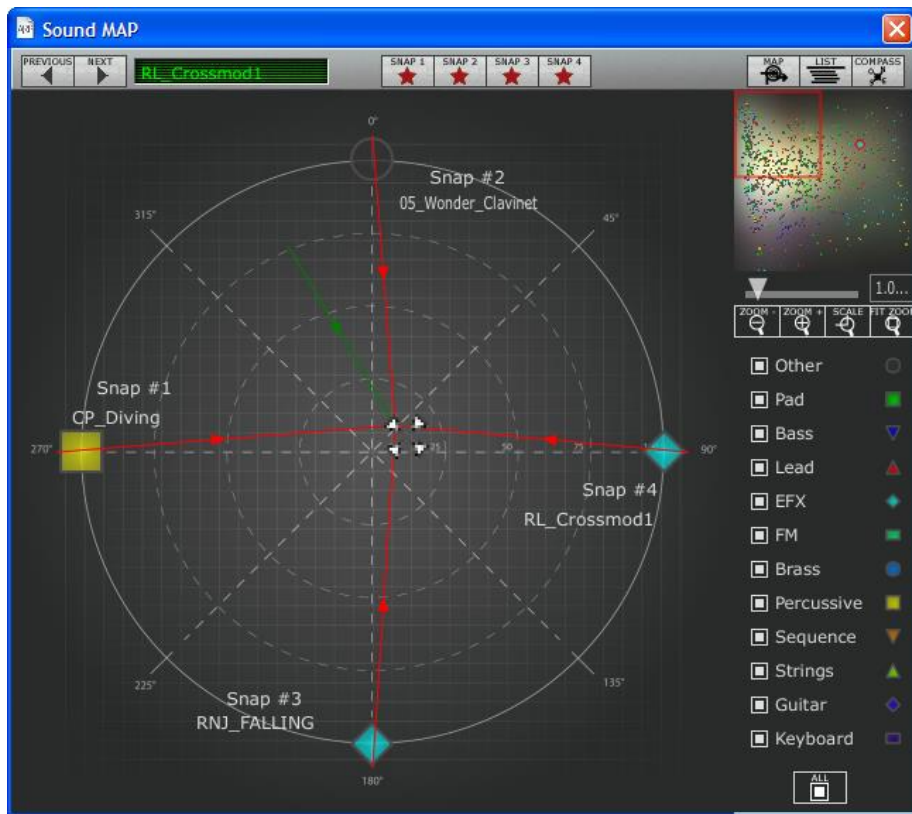

*Create a new sound*

- ▶ If you wish, you can save it on a User bank of the ARP2600 V memory.

## 5 THE MODULES

The ARP2600 V can be separated into 3 parts: from top to bottom, the first is a cabinet dedicated to sound programming and effects, the second concerns the ARP sequencer and the playing mode configuration interface with the keyboard and LFO, and finally the third contains the keyboard.

### 5.1 Sound programming cabinet

#### 5.1.1 Description

The programming section groups all modules which can be used to program sounds. It is also in this screen where the different patches needed in the programming of a sound are made.

It is sometimes necessary to connect a module in the programming section to a module located in the sequencer section.

The sound programming section contains:

- 3 oscillators, which can also be used as modulation sources. (VCO)
- 1 multimode filter. (VCF)
- 1 amplifier (VCA)
- 2 envelopes dedicated to modulations
- 1 noise generator
- 1 ring modulator
- 1 envelope follower
- 1 sample and hold
- 2 mixers (on the filter and the VCA)
- 1 electronic switch
- A tracking generator module
- 5 mixer / lag module
- 2 effects (chorus / delay)

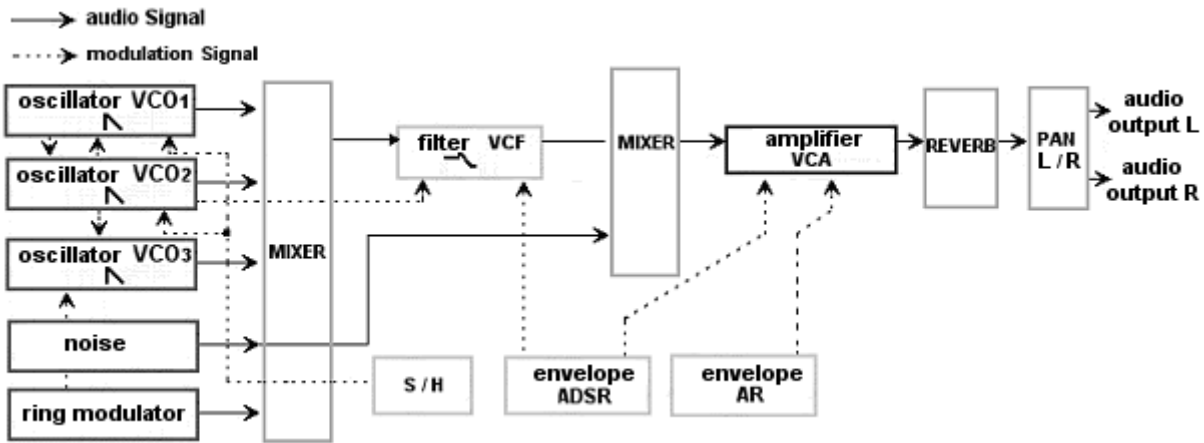

### 5.1.2 The Oscillators (VCO)

There are three oscillators in the ARP2600.

The oscillators permit the management of the base frequency and tone of the ARP 2600. It also manages the impulse width of the waveforms. These changes can either be made with linear potentiometers, or thanks to modulation inputs which can be connected to the output of any module (envelope, low frequency oscillator - LFO -, modulation wheel...).

The oscillators can also be tuned and modulated separately with the potentiometers and a range selector. These oscillators supply up to 4 waveforms that can be used simultaneously.

These 3 oscillators, tuned separately and providing mixed waveforms, quickly give us very rich sounds. The tone can also be easily modified with modulation inputs.

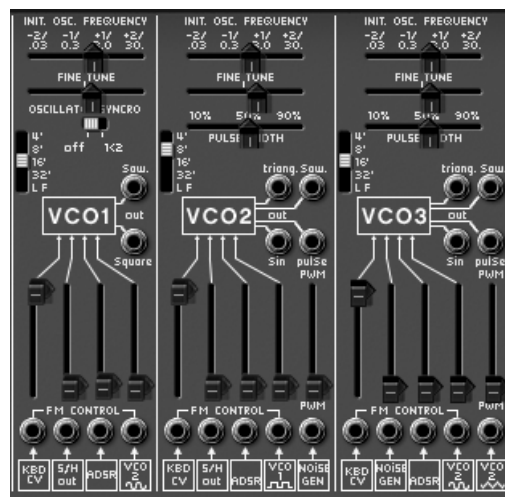

*The 3 oscillators settings*

### 5.1.2.1 Oscillator 1

<b>Range</b>	General tuning of the oscillator by octaves. Up or down 4 octaves and low frequencies
<b>Frequency</b>	Tuning by semi-tone (Initial Oscillator Frequency). Up or down 2 octaves
<b>Fine tuning</b>	Fine tune up or down by up to a semi-tone
<b>Audio outputs</b>	Output sawtooth & square waveform connection jacks
<b>Sync</b>	Synchronization of oscillator1 with 2, 3, or 2 and 3
<b>FM Inputs</b>	Frequency modulation input connection jacks <ul style="list-style-type: none"><li>• <i>Key follow</i>: pre-cabled for the manual setting of the (KYBD CV)</li><li>• <i>Sample and hold</i>: pre-cabled for the manual setting of the modulation by sample and hold (S/H out)</li><li>• <i>ADSR Env</i>: pre-cabled for the manual setting of the modulation by ADSR envelope ADSR</li><li>• <i>Oscillator 2 Sin</i>: pre-cabled for the manual setting of the modulation by sine waveform of oscillator 2 (VCO2 Sin)</li></ul>

### 5.1.2.2 Oscillator 2

<b>Range</b>	General tuning of the oscillator by octaves. Up or down 4 octaves and low frequencies
<b>Frequency</b>	Tuning by semi-tone (Initial Oscillator Frequency). Up or down 2 octaves
<b>Fine tuning</b>	Fine tune up or down by up to a semi-tone
<b>Audio outputs</b>	Connection jacks for 4 waveform outputs: triangle, sine, saw-tooth and square
<b>Impulse width</b>	Impulse width for "Sawtooth", "Square", "Triangle" waveforms
<b>FM Inputs</b>	Connection jack for frequency modulation inputs <ul style="list-style-type: none"><li>• <i>Key follow</i>: pre-cabled for manual setting of the key follow (KYBD CV)</li><li>• <i>ADSR Env</i>: pre-cabled for the manual setting of modulation by ADSR envelope</li><li>• <i>Sample and hold</i>: pre-cabled for the manual setting of modulation by sample and hold (S/H out)</li><li>• <i>Square oscillator 1</i>: pre-cabled for the manual setting of modulation by the square waveform of oscillator1 (VCO1 square)</li><li>• <i>Noise</i>: pre-cabled for the manual setting of modulation of the impulse width of the square by the noise (PWM _ noise out)</li></ul>

### 5.1.2.3 Oscillator 3

<b>Range</b>	General tuning of the oscillator by octaves. Up or down 4 octaves and low frequencies
<b>Frequency</b>	Tuning by semi-tone (Initial Oscillator Frequency). Up or down 2 octaves
<b>Fine tuning</b>	Fine tune on up or down by up to a semi-tone
<b>Audio output</b>	Audio output connection jacks for the sawtooth and square

waveforms

**Impulse width** Impulse width of the "Square" signal

**FM Inputs**

Frequency modulation input connection jacks:

- *Key follow (KYBD CV)*: pre-cabled for the manual setting of the key follow
- *Noise (Noise)*: pre-cabled for the manual setting of the modulation by the noise
- *ADSR Env*: pre-cabled for the manual setting of the modulation by ADSR envelope
- *Sine oscillator 2 (VCO1 sin)*: pre-cabled for the manual setting of the modulation by the sine waveform of oscillator 2
- *Triangle oscillator2*: pre-cabled for the manual setting of the modulation of the impulse width of the square by the oscillator2 triangle (Pulse width modulation \_ VCO2 Triangle)

- ▶ The general tuning of the 3 oscillators is done with the "VCO Initial frequency" potentiometer by +/- one octave per semi-tone.
- ▶ For fine tuning, set the Fine tune potentiometer to +/- one semi-tone.
- ▶ Depending on the position of the "Range" selector switch, the range is of +/- 4 octaves. It is also possible to set it to low frequency position (LF – for low frequency). You will no longer hear any sound, but can now use it as LFO source of modulation.
- ▶ The impulse width applied to the "sawtooth", "triangle" and "square" waveforms of oscillators 2 and 3, can be modified with the "pulse width" potentiometer.

Oscillator 1 possesses two audio outputs for the sawtooth and square waveforms. These can be used simultaneously. The second and third oscillators possess four outputs for the sawtooth, sine, triangle and square.

The frequency modulation inputs (FM Control) and Pulse Width Modulation allow the control of these parameters thanks to the outputs of other modules (an envelope, a LFO for example) They are all pre-cabled to a defined module in advance by the developer of the ARP 2600V2. This is to simplify the use of the synthesizer. For example: the frequency of oscillator 1 can be modulated, from the left to the right, by the key follow, the sample and hold, the ADSR envelope and the oscillator 2 sine. In low frequency position (LF), the oscillators perform modulation using the lower CPU power compared to the other positions.

- ▶ To set the modulation rate, use the linear potentiometer situated above the corresponding jack.
- ▶ You can also connect another source of modulation to each input. This considerably widens the possibilities for sound creation.

For a conventional key follow setting (in relation to the scale) place the potentiometer completely to the top.

Here are graphical representations of the different waveforms used by ARP 2600V oscillators:

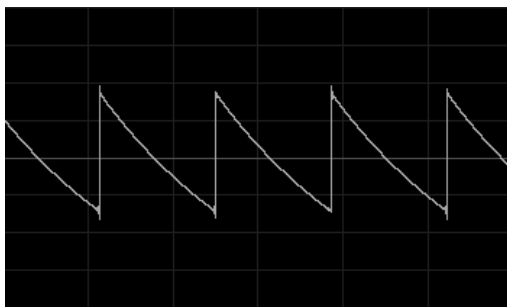

*Sawtooth*

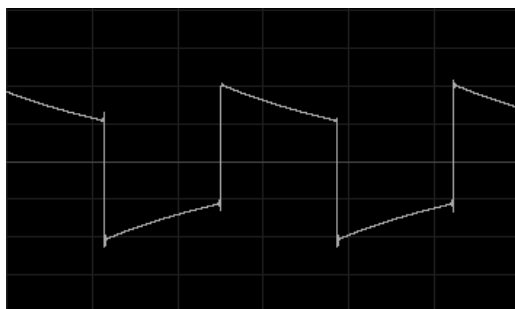

*Square*

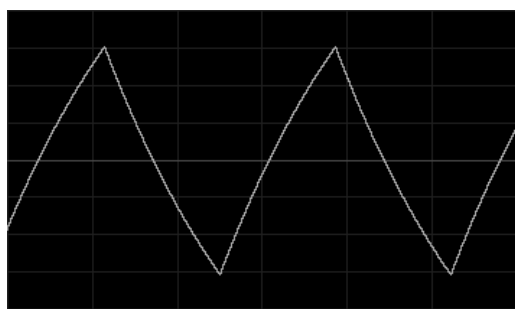

*Triangle*

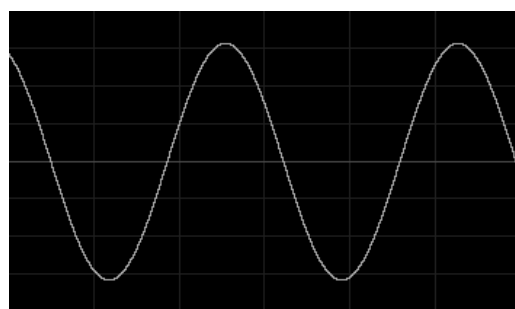

*Sine*

### **5.1.3 The Filter (VCF)**

The ARP2600 V possesses a multimode filter module (the original had only one resonant low pass mode). It is possible to choose a filter type among the five offered: a low pass 24 dB (identical to that found on the ARP2600), a low pass, a high pass, a band-pass and a notch 12 dB of the same kind as the one found on the ARP 2500 modulars. The change of type is done by setting the selector situated on the right of the filter module.

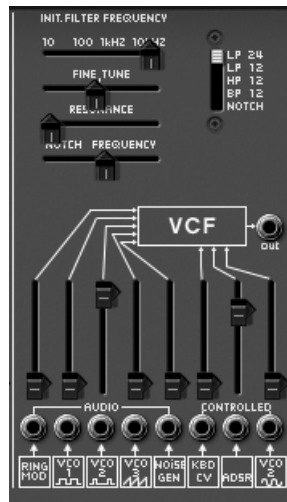

The filter settings

As with the oscillators, the filter possesses audio connections (a mixer) and internal modulation inputs allowing the simplification of its use.

<b>Frequency</b> (Initial Filter Frequency)	Sets the filter cut-off frequency, tuned between 10 Hz and 10 KHz
<b>Fine tuning</b> (Fine tune)	Fine tuning of the filter cut-off frequency
<b>Resonance</b>	Sets the filter resonance
<b>Notch frequency / fc</b> (Notch Frequency/ fc)	Sets the frequency of the notch divided by the filter cut-off frequency
<b>Filter type selector</b> (Types)	Type of filter (LP 2600 and 2500, HP, BP and notch)
<b>Audio output</b> (Output)	Filter audio output connection jacks
<b>Audio input</b> (Audio)	Filter input connection jacks (initially connected to the ring modulator, to the oscillators1 and 2 square, oscillator3 sawtooth and noise)
<b>Modulation inputs</b> (Control)	Filter frequency modulation input connection jacks. <ul style="list-style-type: none"> <li>• <i>Key follow (KYBD CV)</i>: Pre-cabled for the manual setting of the key follow</li> <li>• <i>Oscillator3 sine (VCO3 Sin)</i>:pre-cabled for the manual setting of the modulation by sine waveform of oscillator2</li> <li>• <i>ADSR Env</i>: re-cabled for the manual setting of the modulation by ADSR envelope.</li> </ul>

It possesses a cut-off frequency setting and a resonance setting.

A setting separated from the notch filter frequency (Notch frequency) divided by the initial filter cut-off frequency has been added. This very particular parameter (present on the module of the ARP2500) transforms the notch filter to a low shell or high shell filter.

As for all other modulation inputs, once connected, its amplitude is set by raising the linear potentiometer. With a right click, we obtain a higher level of precision. Receiving a modulation coming directly from the output of a generator (envelope, oscillator, sequencer), the maximum amplitude of modulation of +/- 9 octaves.



Only the cut-off frequency can be dynamically modulated by one of the 3 modulation inputs.

For a conventional key follow setting (in relation to the scale) place the potentiometer completely to the top.

#### 5.1.3.1 The filter types:

- The low pass 24dB / oct Low pass (LP 24)  
The low pass 24dB filter is typical of the ARP2600. It eliminates the frequencies situated below the pivotal frequency (the cut-off frequency).

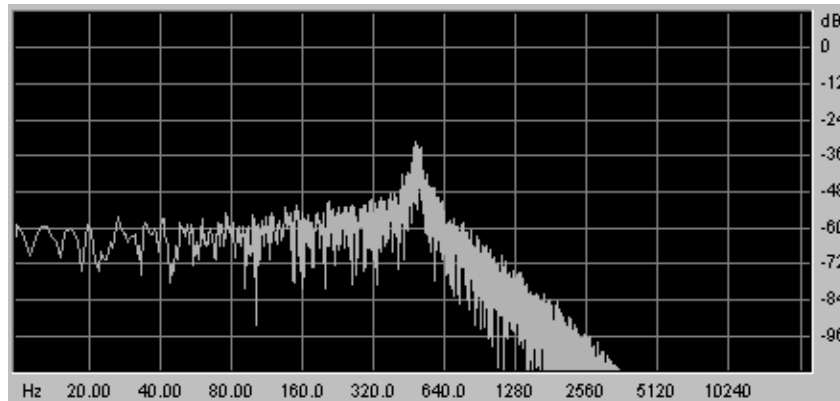

*The low pass filter*

The four other filtering modes didn't exist on the original ARP2600 but existed on the ARP2500 modular systems. They all use a filtering slope at 12 dB/ octave. These modes were added to increase the possibilities for sound creation on the ARP 2600 V 2.5.

- The low pass 12dB / octave (LP 12)  
The low pass 12 dB filter works in the same manner as the 24 dB/ oct. on the the ARP2600. It will just give you a slightly different result due to the fact that its filtering slope is not as fast.
- The high pass (HP 12)  
The high pass filter is the opposite of the low pass filter. It eliminates the frequencies above the cut-off frequency.

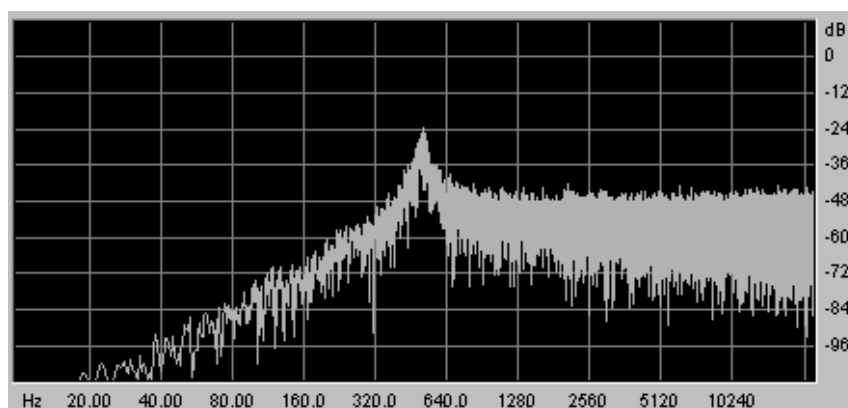

*The high pass filter*

- The band pass filter (BP 12)  
The band pass filter is a combination of the low pass and high pass: It eliminates the frequencies on each side of the cut-off frequency.

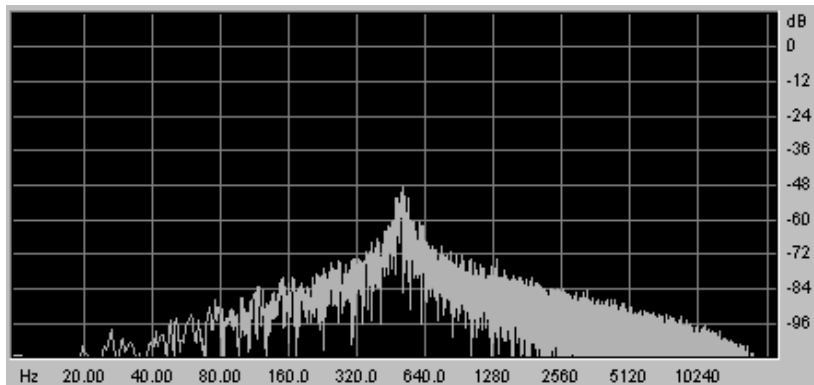

*The band pass filter*

- The notch filter (Notch)

The notch filter coupe is the opposite of the band pass filter. It eliminates the frequency band situated on both sides of the cut-off frequency.

The resonance can be used to accentuate the "hollow" of this frequency band.

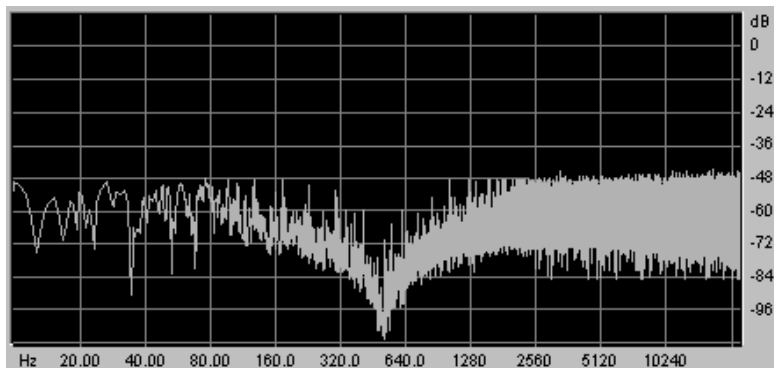

*The notch filter*

⚠ if you raise the resonance too high, the result of the filtering will no longer be heard as the frequency band will be too big to allow efficient filtering.

#### **5.1.4 The envelopes**

Two in number, the modulation envelopes allow the evolution of the sound in relation to the time.

The first envelope (ADSR) possesses four temporal periods which are performed sequentially: the Attack time, Decay time, Sustain voltage and the Release time. When the trigger input moves to active state (triggering of a note), the envelope performs the sequences "Attack" followed by "Decay" and remains in the "hold" state (Sustain) as long as the input trigger remains active. When it goes to the inactive state (release of the note), the envelope performs the "fall" sequence (Release).



ADSR and AR envelopes settings

#### 5.1.4.1 ADSR

<b>Attack</b> (Attack time)	Sets the attack time
<b>Decay</b> (Decay time)	Sets the decay time
<b>Hold</b> (Sustain Voltage)	Sets the level of the hold
<b>Release</b> (Release time)	Sets the release time
<b>Output</b> (Output)	Envelope output signal

#### 5.1.4.2 AR

<b>Attack</b> (Attack time)	Sets the attack time
<b>Release</b> (Release time)	Sets the release time

#### 5.1.4.3 Trigger modes

<b>Trigg input</b> (S/H gate)	Input connection for an external trigger signal (pre-cabled to the Sample and Hold clock)
<b>"Gate" output type</b> (Gate)	Output connection for a "gate" type signal: for every note played on the keyboard, the signal remains active as long as the note is held down.
<b>"Trigger" output type</b> (trig)	Output connection for a "trigger" type signal: each note played by the keyboard presents a sustain time reduced to the minimum.
<b>Switch Sample and Hold clock</b>	<b>"trigger and by Hold"</b> (S/H gate): Selection of the choice of envelope trigger - AR and ADSR - by the keyboard or Sample and Hold clock. This function reactivates the envelopes at every clock cycle.

### 5.1.5 Output amplifiers (Voltage Control Amplifier - VCA)

The amplifier is the last step in the conception of a preset. It sets the general volume of the sound.

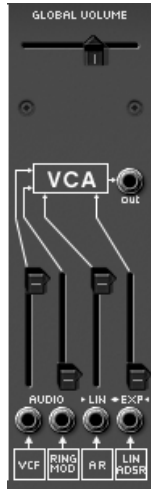

*The VCA settings*

This module is very simple; it contains:

<b>Gain</b> (Initial Gain)	Sets the general synthesizer volume
<b>Audio input</b> (Audio VCF / ring mod)	Audio input connection jack (pre-cabled to the filter and ring mod audio outputs).
<b>Modulation inputs</b> (Control)	Modulation input connection jacks (pre-cabled on the AR and ADSR envelopes).

### 5.1.6 Noise Generator

The noise generator generates white noise or colored noise. It possesses a low pass filter to dampen high pitched frequencies.



*The noise generator*

<b>Low pass frequency</b> (White / Low Freq)	Sets the cut-off frequency of the low pass filter.
<b>Noise volume</b>	Sets the noise volume.
<b>Noise generator output</b> (Noise generator output)	Noise out connection jack.

### 5.1.7 Voltage processor (Mixer / inverter / lag generator)

The voltage processor allows you to mix up to 8 inputs (audio or modulation) to one (or several) outputs.

It also allows you to invert the input signal – a positive-going modulation (an envelope for example) will thus become negative.

A lag generator allows you to smooth an input signal. For example, the square signal from a LFO approximates a triangle the more we raise the potentiometer value, increasing the lag time.

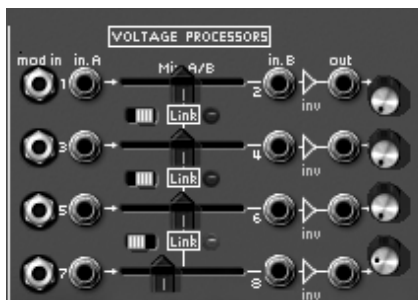

*The voltage processor*

<b>8 signal inputs</b> (input)	Audio or modulation signal input connection jacks.
<b>4 balance</b> (mix)	Sets the balance between the two input signals
<b>4 inverters</b> (inverter)	Inverts the input signal
<b>4 lag generators</b>	Smooths the input signal
<b>4 signal outputs</b> (output)	Audio or modulation signal output connection jacks
<b>4 "Mix" switches</b>	This switch allows you to merge one or several inputs pairs into the one above.
<b>4 "Volume" potentiometers</b>	Potentiometer to set the volume of 2 input signals (A and B for example)

### 5.1.8 Sample and Hold generator

This module lets you sample the signal connected as input. The source can be external (source of trigger connected to the input) or pre-cabled to the noise generator. This module allows you to create random modulations by sampling the noise signal, for example.

You can also connect an external clock source to pilot the sample and hold speed (the waveform output of an oscillator for example).

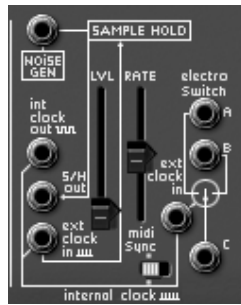

*The sample and hold settings*

<b>Level</b> (Level)	Sets the Sample & Hold modulation level.
<b>Rate</b> (Rate)	Sets the Sample & Hold clock speed.
<b>External Input</b> ("Noise gen")	Audio or modulation external signal input connection jack. (pre-cabled to the noise module)
<b>Sample and Hold output</b>	Sample and Hold output connection jack
<b>Internal clock output</b> (Int Clock out)	Sample and Hold internal clock output connection jack
<b>External clock input</b> (Ext Clock in)	External clock input connection jack
<b>MIDI Synchronization</b> (MIDI sync)	Selector switch for the synchronization of the clock to a MIDI sequencer.

### 5.1.9 The "electronic switch" module (Electronic switch)

The "Electronic switch" module allows you to alternate the two sources connected to inputs A and B depending on the speed of the clock connected (pre-cabled to the Sample and Hold clock) to create a composite source of modulation.



*The electronic switch*

An example:

- ▶ Connect the output of the square waveform of oscillator 1 to input A and the sine output of oscillator 2 to input B.
- ▶ Place these two oscillators to low frequency position (LF) so as to slow the oscillation speed. Set the frequency potentiometers for the two oscillators to 0.3 Hz.
- ▶ Connect output C of the interrupter to one of the filter modulation inputs.
- ▶ Set the Sample and Hold clock speed potentiometer towards the bottom to clearly hear the alternation between the two modulations.

<b>Inputs</b> (A / B)	Audio or modulation signal input connection jacks.
-----------------------	--

<b>Selector switch (C)</b>	Selector switch C connection jacks between signals A and B
<b>External clock input</b> (Ext clock In)	External; clock connection jacks (pre-cabled to the Sample and Hold clock)

### 5.1.10 Envelope follower

The envelope follower allows the generation of a modulation from an external (or internal) source of audio signal. The (Pre amp.) volume parameter sets the fineness of the envelope follow. The lower it is, the more closely the variations of the input signal will be followed.



*The preamplifier*



*The envelope follower*

An example:

- ▶ Try for example to insert an audio signal coming from a drum loop sample to the input of the envelope follower.
- ▶ Connect the output of the envelope follower to one of the filter modulation inputs.
- ▶ Increase the modulation rate for the amp (VCA).
- ▶ Do the same for the envelope follow level. The VCA volume will modulate the volume of the VCA with the envelope of the drum loop audio sample.

<b>Audio input</b> (Pre-Amp)	Envelope follower audio input connection jack
<b>Output</b> (Output)	Output jack fo the audio signal
<b>Level</b> (Level)	Sets the amount level of the envelope follower
<b>Gate out</b> (gate out)	Trigger signal output connection jacks

### 5.1.11 Ring modulator

The ring modulator is a module which allows you to multiply two signals in order to generate non-harmonic frequency components. It is useful for creating metallic sounds.



The ring modulator

<b>2 Audio inputs</b> (VCO1 Saw / VCO2 Sin)	Audio input connection jacks (pre-cabled to the oscillator1 sawtooth and oscillator 2 sine outputs).
<b>Output</b> (Output)	Ring modulator output connection jacks

### 5.1.12 "Tracking" generator

This very original module was added to modify the course of a modulation thanks to four curves which can be edited in real-time by the user. It can also be used as source of modulation to create envelope forms or complex LFO waves.

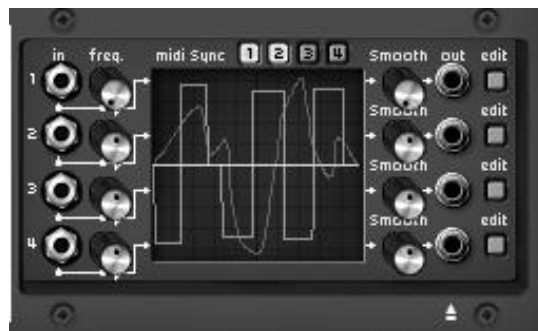

The tracking generator's main interface

- Main interface:

<b>4 audio inputs</b>	Audio input signal connection jacks.
<b>4 modulation inputs</b>	Modulation input signal connection jacks
<b>4 audio outputs</b>	Audio signal input connection jacks.
<b>4 "Smooth"</b>	Sets the smoothness of the tracking curve.
<b>4 Edit</b>	Button for opening the tracking curve edit mode.

- Edit interface



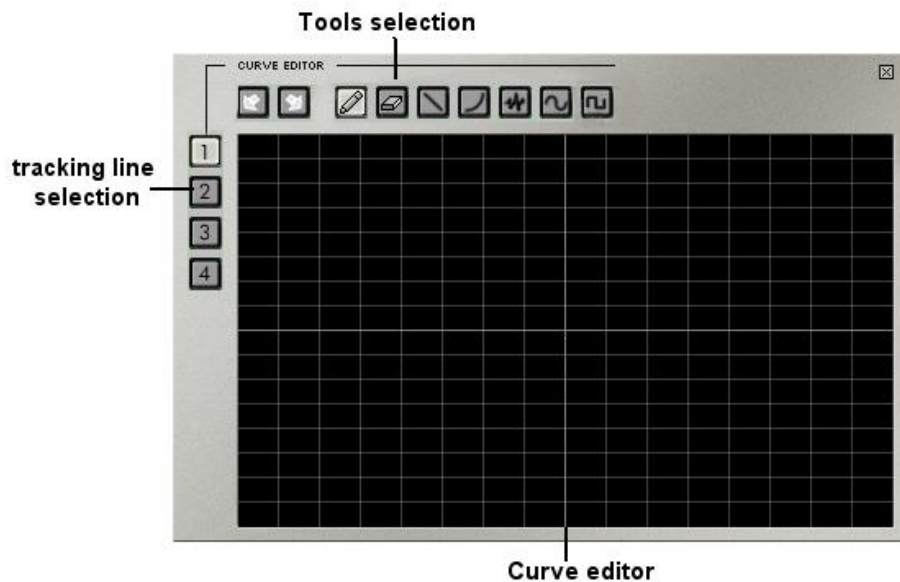

<b>Curve editing screen</b>	Screen for real-time curve editing.
<b>Drawing tool</b>	Tool for drawing a freehand curve.
<b>Line tool</b>	Tool for drawing a straight line.
<b>Curve tool</b>	Tool for drawing an exponential curve.
<b>Sine tool</b>	Tool for drawing a sinusoid.
<b>Square tool</b>	Tool for drawing a square signal.
<b>Noise tool</b>	Tool for adding noise to an existing signal.
<b>Eraser tool</b>	Tool for erasing an existing signal.
<b>Undo / Redo</b>	To undo or redo a drawn signal.

A few tips for using it:

- ▶ To create an exponential curve: Firstly click on the editing screen to place the starting curve for the curve.
- ▶ Drag (without releasing) to draw the curve.
- ▶ Click and drag up or down to set the amplitude.
- ▶ Click once again to validate this curve.

### 5.1.13 Reverberation

This module lets us add reverberation to the sound.



*The reverb module*

<b>Right effect level</b> (Level)	Sets the output level for the right reverberation
<b>Left effect level</b> (Level)	Sets the output level for the left reverberation
<b>Right output</b> (Output R)	Right output connection jack (with or without reverberation)
<b>Left output</b> (Output L)	Left output connection jack (with or without reverberation)
<b>Dry input right</b> (Dry input right)	Dry right input connection jack
<b>Dry input left</b> (Dry input Left)	Dry left input connection jack

#### 5.1.14 Chorus and delay effects

Chorus has three potentiometers, "Rate" "Depth" and "Dry/Wet" which allow us to respectively set the speed, the depth and the relation between the original and modified signals.



*The chorus effect*

Delay has two potentiometers, "Time Left" and "Time Right", respectively for setting the time for the left channel, and the right channel. The two potentiometers, "FeedB Left" and "FeedB Right" respectively set the channel return gain for left and right channels. Finally the "Dry/Wet" potentiometer sets the ratio between the original and modified signals.

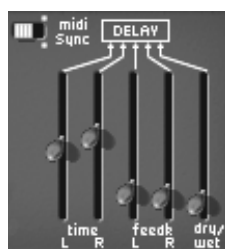

*The delay effect*

The "Midi Sync" selector switch allows us to synchronize the return time for the delay to the tempo of the host application.

#### 5.1.15 Control voltages (CV control)

These modulation outputs allow us to control the synthesizer parameters with the real-time controllers of your MIDI keyboard.



*The CV controls*

<b>Pitch bend wheel</b> (Pitch bend)	Output connection jack for the control of modulation of three oscillators with the pitch bend wheel.
<b>Modulation wheel</b> (Mod Wheel)	Output connection jack for modulation control with the help of the modulation wheel.
<b>Velocity</b> (Velocity)	Output connection jack for velocity control.
<b>After Touch</b>	Output connection jack for After Touch control.
<b>Key follow outputs x1 and x4</b> (KYBD CV output)	Output connection jacks for key follow x1 (tempered key follow) and x4

## 5.2 Keyboard interface (Model 3620)

The keyboard interface contains all of the parameters necessary for playing on a keyboard: the monophonic or polyphonic playing modes, the portamento, the LFO (mainly used for vibrato), keyboard triggering modes, etc...

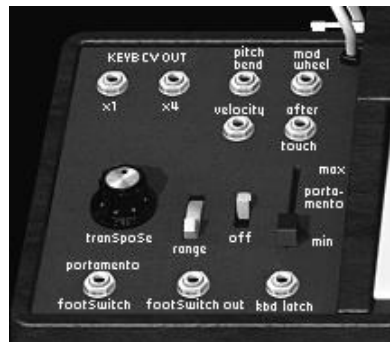

*The keyboard interface*

<b>Portamento trigger input pedal</b> (portamento footswitch)	Output connection jack for portamento trigger control with a pedal.
<b>Sustain trigger input pedal</b> (KBd Latch)	Input connection jack for Hold trigger control with a pedal.
<b>Play mode selector</b> (Modes)	Selection of keyboard play mode - monophonic, unison, polyphonic.
<b>Detune polyphonic voices</b> (Unison detune)	Sets the detuning of the voices in "unison" mode.
<b>Select trigger modes</b> (Trigger modes)	Selects trigger mode for keyboard notes: legato / retrigger
<b>Pitch Bend</b>	Simultaneously sets the frequency of the three oscillators.
<b>Global tuning</b> (Global tune)	Simultaneously set the global tuning of the three oscillators

### 5.3 Low frequency oscillator (LFO)

The use of a low frequency oscillator as source of modulation is quite common. It allows us to make the tone of a sound evolve gently or to create a vibrato or tremolo effect.

Even though three oscillators can be used at very low frequencies, there is a specific module for this, allowing you to dedicate the oscillators to generation in the audible domain.



*The LFO*

<b>Low frequency oscillator speed</b> (LFO speed)	Sets the clock speed for the low frequency oscillator.
<b>Low frequency oscillator delay</b> (LFO delay)	Sets the delay of the low frequency oscillator action.
<b>Vibrato depth</b> (vibrato depth)	Sets the depth of the vibrato.
<b>MIDI synchronization</b> (MIDI sync)	The "Midi Sync" selector switch lets you synchronize the low frequency oscillator clock with the MIDI tempo.
<b>Triangle output</b> (LFO triangle)	Audio output of the LFO triangle waveform.
<b>Square output</b> (LFO Square)	Audio output of the LFO square waveform.
<b>Sawtooth output</b> (LFO Saw)	Audio output of the LFO sawtooth waveform.
<b>Sine output</b> (LFO Sine)	Audio output of the LFO sinusoid waveform
<b>External vibrato input</b> (LFO External Vibrato in)	Audio input for external LFO source.

### 5.4 The ARP sequencer

This module was born of the original ARP sequencer model 1601 (18). It was one of the most widely used sequencers in the 70's and early 80's.

With this module, you will create melodic sequences or step by step variations applied to synthesizer parameters (a sequence line applied to the opening of the frequency of a filter can be very effective, for example).

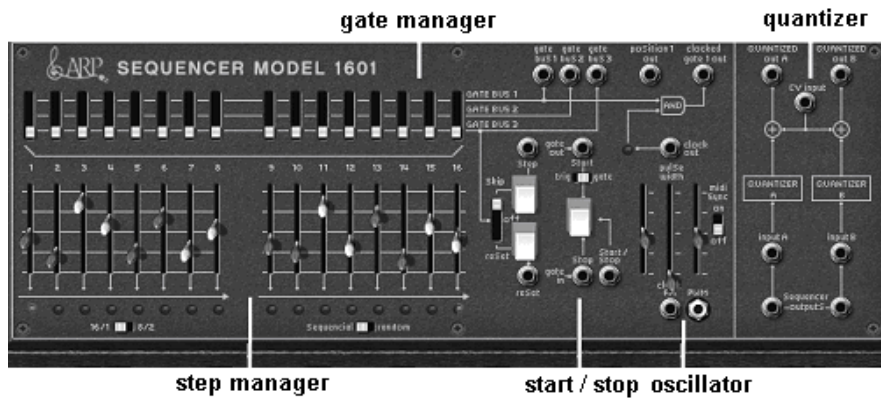

- Sequence step management, setting and management of the 16 sequencer steps

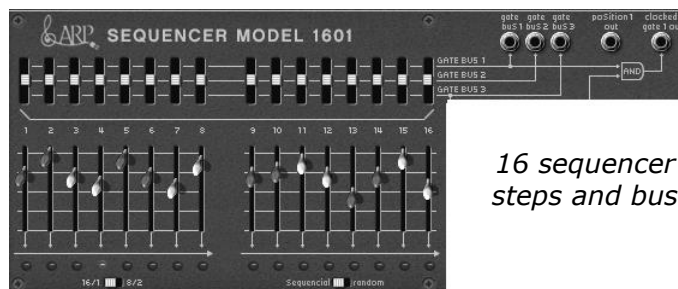

*16 sequencer steps and bus*

<b>2x8 output levels</b> (1 ... 16 faders)	Sets the modulation or tuning level for sequence steps.
<b>Bus 1, 2 and 3</b> (switches Gate bus 1, 2, 3)	Trigger selector switch for steps by bus 1, 2 or 3
<b>Bus inputs 1, 2 and 3</b> (inputs Gate bus 1, 2, 3)	Input jacks for bus 1, 2 or 3
<b>Position</b>	Position input jacks
<b>Sequencer clock output</b> (Clocked gate out)	Sequencer clock output jack

- Sequencer oscillator

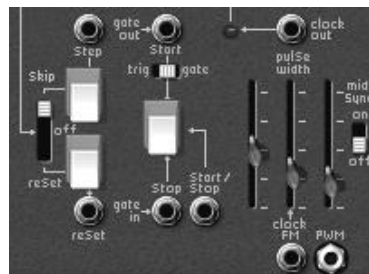

*The sequencer oscillator*

<b>Skip / return</b> (Skip/Off/reset Steps)	Selector switch for skipping steps or returning to step 1
<b>Skip steps</b> (Step)	Button for manual choice of steps.
<b>Return input</b> (Reset)	Input jack for a forced return to step 1.

<b>Start input (trig or gate)</b> (Jack Start)	Input jack to start the sequencer with a trig or gate signal.
<b>Trig or Gate</b> (trig / gate)	Selector switch for choice of trig or gate (starting the sequencer).
<b>Start / stop</b> (Start / Stop)	Button for manual starting / stopping of the sequencer.
<b>Start / stop jack</b> (Start / Stop jack)	Input jack for sequencer start / stop.
<b>Start / stop pedal</b> (Start / Stop pedal)	Pedal to start and stop the sequencer.
<b>Clock frequency</b> (Clock Freq)	Sets the sequencer clock speed
<b>Clock frequency output</b> (Clock out)	Input jack for the sequencer clock output.
<b>Clock FM</b> (FM)	Sets the modulation rate for the clock frequency.
<b>FM input</b> (Clock FM)	Jack input for the modulation of the clock frequency (initially connected to the "gate" input)
<b>Impulse modulation</b> (Pulse width)	Sets the rate of modulation for the signal impulse width.
<b>PW input</b> (PWM)	Jack input for the modulation of the impulse width of the signal.

- Setting the sequencer input / outputs (quantizer)

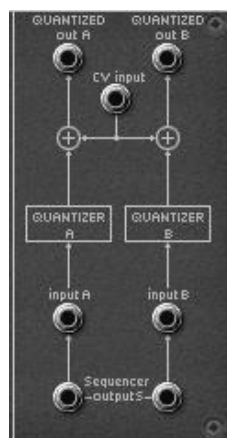

*The sequencer input / outputs*

<b>Quantized outputs A and B</b> (Quantized outputs A/B)	Output jacks A and B for the quantization of the step signals in semi tones.
<b>CV input</b> (CV input)	Jack inputs manage the reference voltage for the sequencer (generally connected to CV keyboard control - Kybd CV output)
<b>Quantized inputs A and B</b> (Quantized inputs A/B)	Input jacks A and B for the signal quantization.
<b>Non quantized outputs A and B</b> (Sequencer outputs A/B)	Output jacks A and B non quantized (continuous values to +/- 4 octaves)

## 6 THE BASICS OF SUBTRACTIVE SYNTHESIS

Of all forms of sound synthesis, subtractive synthesis is one of the oldest and still certainly one of the most employed today. It is this method that was developed toward the end of the 60's on analog synthesizers like the ARP, Oberheim, Yamaha, Buchla, Sequential Circuits (Prophet series), Roland, Korg (MS and PS series), Bob Moog's creation and many others. This concept of synthesis is still used on most current digital synthesizers, complementing sample reading or wave tables, which progressively replaced the analog oscillators of the first synthesizers in the 80's. The ARP2600, or even your own ARP2600 V are among the best illustrations of the enormous possibilities of subtractive synthesis.

### 6.1 The three main elements

#### 6.1.1 The oscillator or VCO

The oscillator (**Voltage Controlled Oscillator**) is the starting module (with the noise module which is often classed among the oscillators) for the creation of a sound on an analog system.

It will generate the initial sound signal. We can think of the oscillator like a violin string that once stroked or plucked, vibrates to create its sound.

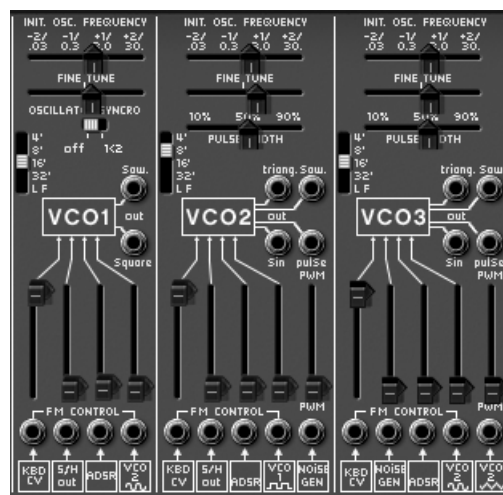

*The oscillator settings on the ARP2600 V*

The main oscillator settings are:

- ▶ **The pitch** is determined by the oscillation frequency. You can set the frequency of the oscillator with 2 controllers: first, the "RANGE" selector which determines the fundamental frequency – it is expressed in feet- : Low, 32, 16, 8, 4, 2; the highest number (32) brings the deepest tone, inversely, the smallest number (2) brings the highest tone. – Secondly, the detune setting ("FREQUENCY") lets you tune the oscillator more precisely.
- ▶ **The waveform** which determines the harmonic richness of the audio signal. On the ARP2600 V, four waveforms are available:

- The **saw tooth** presents the richest audio signal of the four waveforms (it contains all of the harmonics at decreasing volume levels in high frequencies). Its sound is ideal for brass sounds, percussive bass sounds or rich accompaniments.

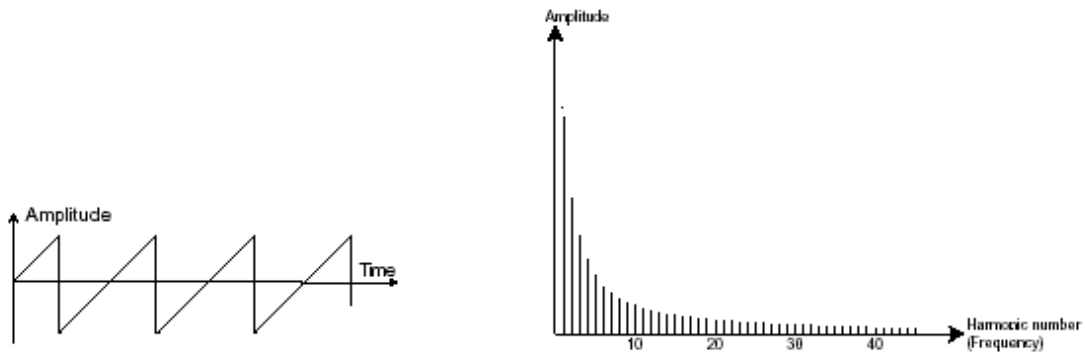

- The **square** possesses a more “hollow” sound than the sawtooth (it only contains odd harmonics) but none the less, its rich sound (notably in low frequencies) can be used for sub-bass sounds that will come out well in the mix (the square oscillator is often set an octave below that of the sawtooth), wood sounds (clarinet, if the square signal is a little filtered), etc.

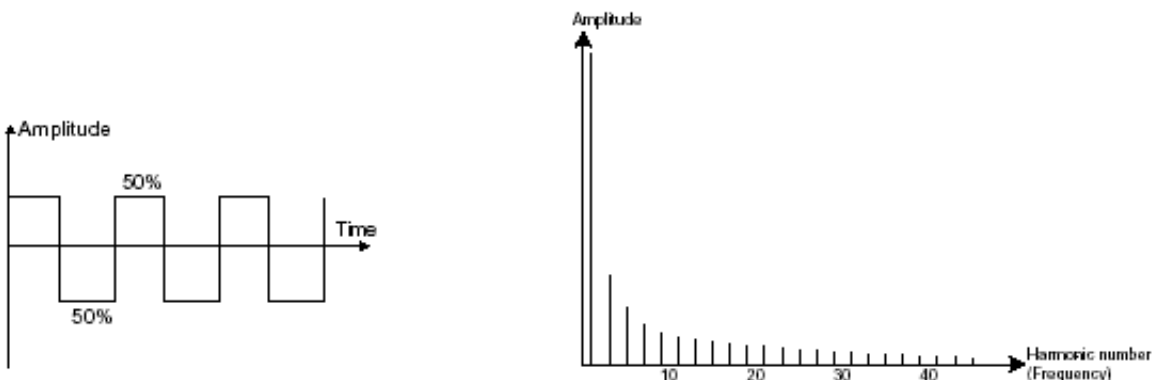
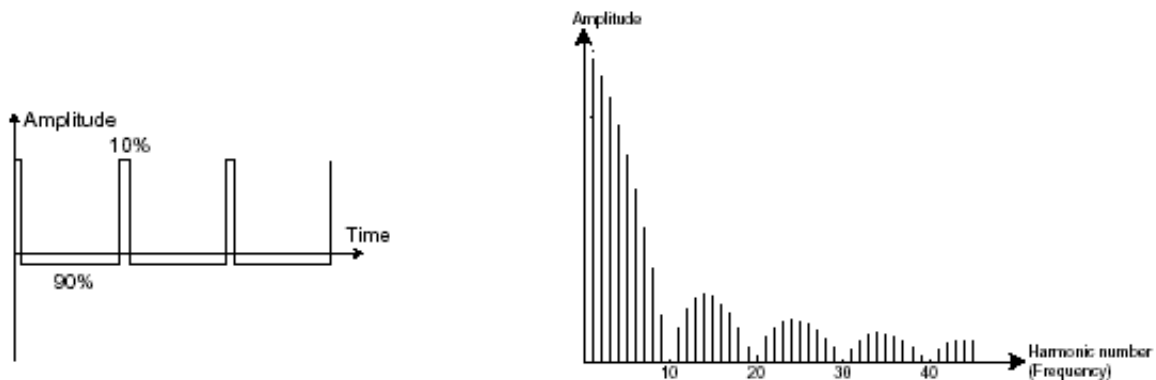

- The **triangle** can be considered like a very filtered (and soft) square signal. It is very low in harmonics (odd only) and will be very useful for creating sub basses, flute sounds, etc....



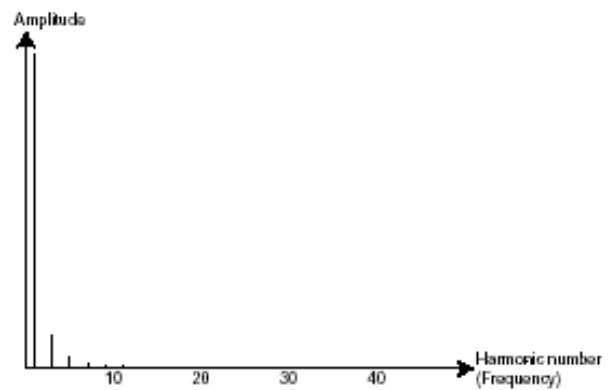
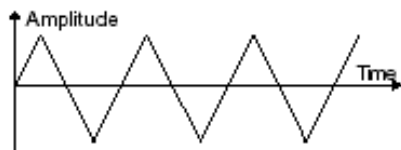

- ▶ The **sinusoid** is the purest of all. It is a single harmonic and produced a very “damped” sound. It can be used to reinforce the low frequencies of a bass sound or as a frequency modulator in order to create harmonics that don’t exist in the original waveforms.

**sine**

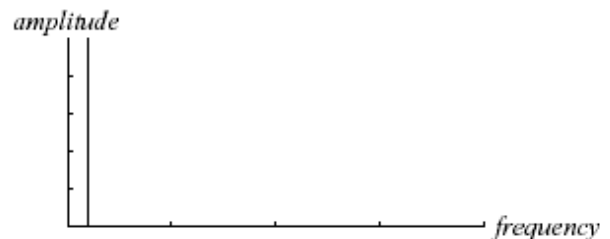
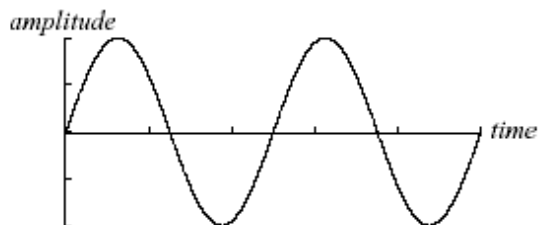

**PWM (Pulse Width Modulation)** is a setting that allows you to modify the waveform cycle (or wave length). This can be done manually with the help of a knob “**PW**” or by modulation (with an envelope or LFO). This pulse width variation translates to a spectrum modification, resembling a waveform change.



*The ARP2600 V waveforms on the oscillator2*

The **synchronization** of an oscillator with another creates more complex waveforms. If for example, you synchronize oscillator2 with oscillator1, oscillator2 will restart a new period every time the first oscillator completes a period, even if oscillator2 has not completed a complete period (this signifies that it is not tuned to the same tonality!) The more you tune oscillator2 upwards, the more you will encounter composite waveforms.

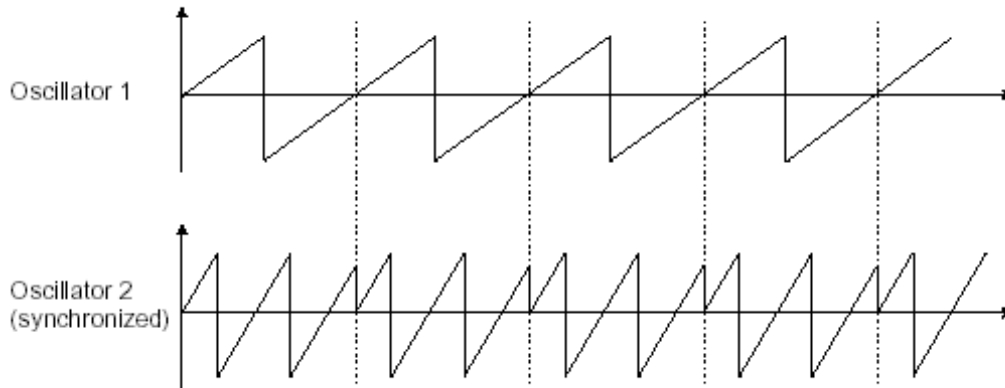
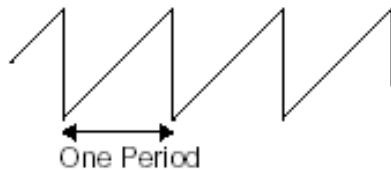

*In the above image, oscillator2 is synchronized with the first and tuned to twice its frequency. The resulting waveform is unique in that it cannot be created by standard synthesis techniques such as layering or filtering.*

A **frequency modulation (FM)** can be created between 2 oscillators by connecting the audio output from a first sinusoidal oscillator to the modulation input of a second oscillator. On the ARP2600 V, if you turn the modulation rate ring, you will obtain a sound richer in harmonics. If you introduce a square or saw tooth signal, the result can be quickly distorted... but interesting for inharmonic sonorities like bell sounds or special effects for example.

**FM**

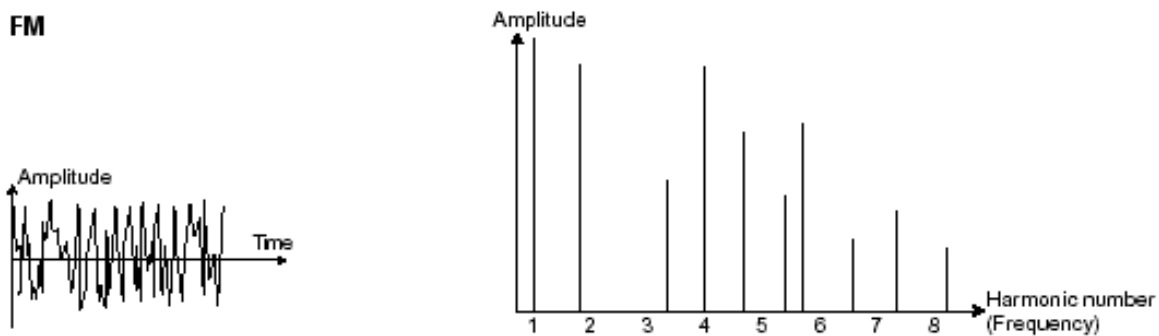

*The noise module*

The noise signal spectrum has all frequencies at an equal volume level, often referred to as "white noise". For this reason, the noise module is used to create different noises like the imitation of wind or special effects. White noise is the richest of noises. Pink noise is also regularly present on synthesizers. It is less rich in the high frequencies than white noise.

Also note that the audio output of noise can also be used as a modulation signal (especially when strongly filtered) to create random cyclic variations.



The ARP2600 V noise module

### 6.1.2 The filter or VCF

The audio signal generated by an oscillator (the waveform) is next generally directed to a filter module (**Voltage Controlled Filter**). It is this module that we use to control the sound by filtering (by subtraction, which explains the name given to this type of synthesis) the harmonics situated around a cut-off frequency. It can be considered to be a sophisticated equalizer that reduces, depending on the case, the high or low frequencies of a sound.

The removal of undesirable frequencies at the cut-off frequency is not done suddenly but progressively, depending on the filtering slope. This filtering slope is expressed in decibels per octave (or dB/Oct). The filters used in classic analog synthesizers have 24 dB/Oct or 12 dB/Oct slopes.

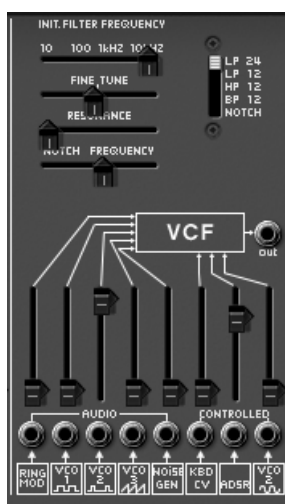

The ARP2600 V filter module

The ARP 2600 V offers two types of slope: 24 and 12 dB/Oct slopes.

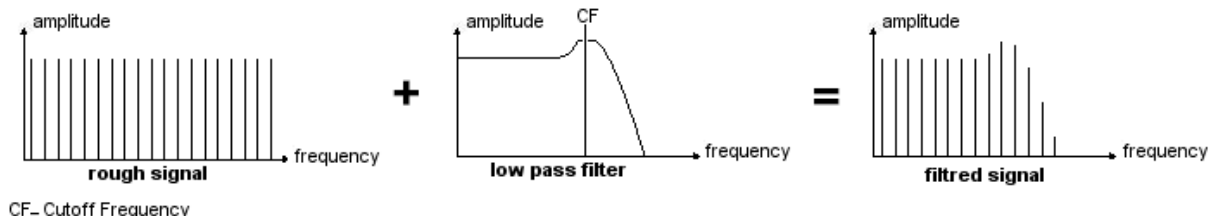

On the ARP2600 V, you have access to four types of filtering. Let's have a look at some of his properties:

- The low-pass filter (*LPF*) progressively removes high frequencies above the assigned frequency limit (the cut-off frequency) and allows the sound below the cut-

off to pass through unchanged. Depending on the setting we will hear the sound becoming more or less “brilliant”, more or less “dampened”.

This is the type of filtering that you will find more often than not on synthesizers that use subtractive synthesis. It can be found on most of the recent analog and digital synthesizers.

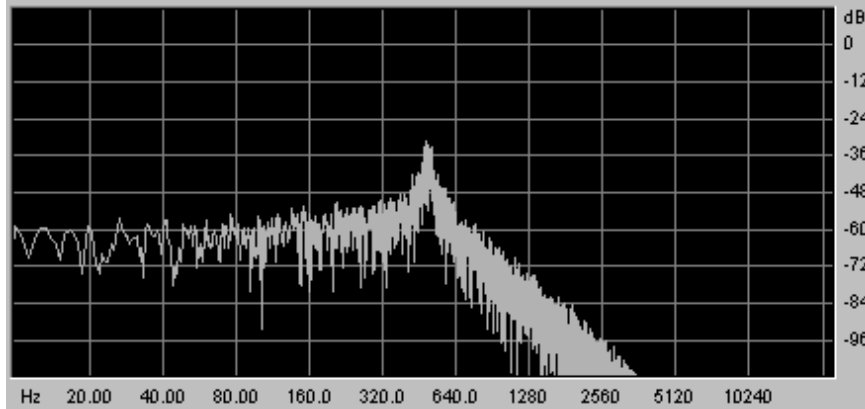

*Spectrum of a noise signal proceed with a low-pass filter*

- The high-pass (high-pass filter or HPF), as opposed to the low-pass, eliminates low frequencies and only allows high frequencies past. The sound will thus become “thinner”. It is very useful for removing redundant low frequencies.

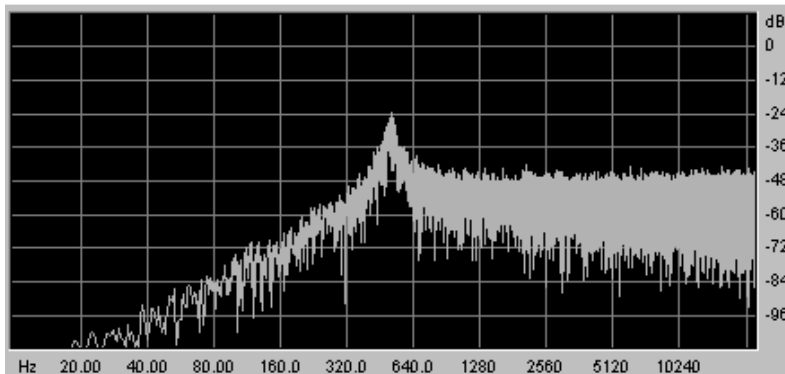

- The band-pass (band-pass filter or BPF) eliminates the frequencies situated on either side of the cut-off frequency. Use it to make a certain band of frequencies that you wish to emphasize appear. This will make the sound more “pinched”.

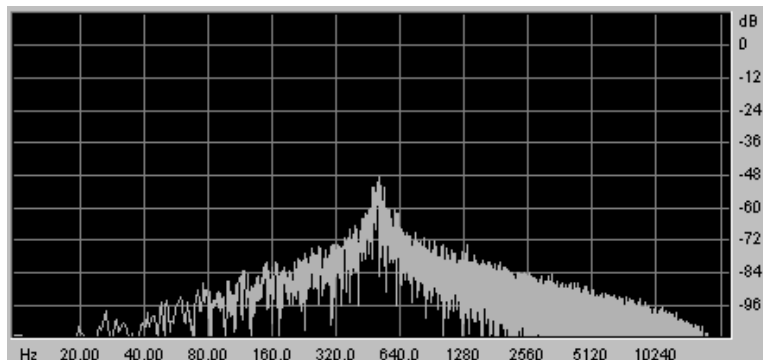

- The band-reject (band-reject filter or notch) eliminates the frequencies inside a band of frequencies. This filter is above all else interesting when we want to vary this band of frequencies (with the “frequency” on the ARP2600 V filters or the modulation of an LFO on this same parameter). You will thus obtain a sound close to a “phasing” effect.

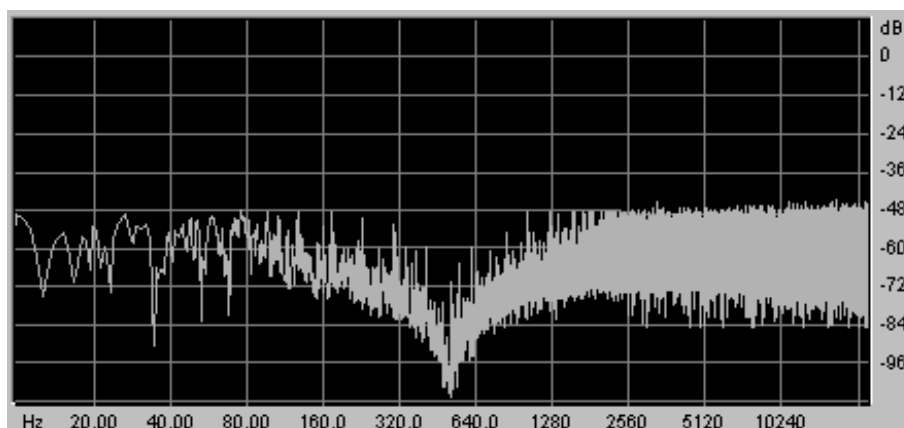

These four types of filtering are often used on analog synthesizers.

A second setting to compliment the cut-off frequency: the resonance.

(you will also find it called “emphasis” or “Q” – for Quality of filtering)

The resonance amplifies frequencies close to the cut-off frequency. The other frequencies remaining are either unchanged (below the cut-off frequency) or reduced (above the cut-off frequency).

On the ARP2600 V, you can increase the rate of resonance through the “resonance” potentiometer.

When you increase the resonance, the filter becomes more selective, the cut-off frequency is amplified, and the sound begins to “whistle” at the cut-off frequency.

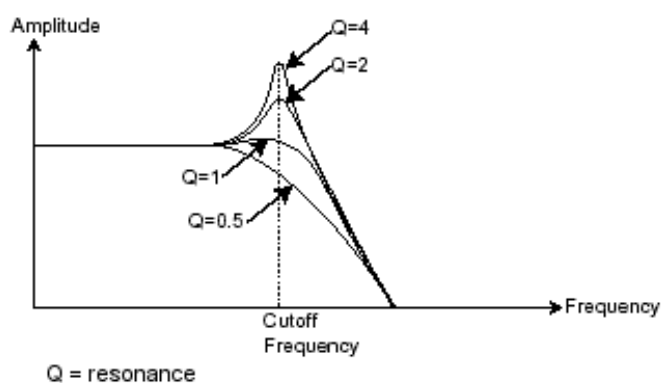

With a high resonance level, the filter will begin to produce a sound close to a sine waveform. At this stage, the use of a key follow is very important as you can create a melody by tuning the cut-off frequency of the filter along with the frequency of the oscillators.

### 6.1.3 The amplifier or VCA

The amplifier (Voltage Controlled Amplifier) is charged with receiving the audio signal coming from the filter (or directly the one from the oscillator if it is not filtered) to adjust its volume with a potentiometer, before the signal is directed to the speakers.

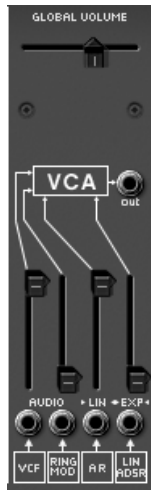

The ARP 2600V amplifier

In conclusion, here is a scheme that may help you to understand the composition of a basic sound:

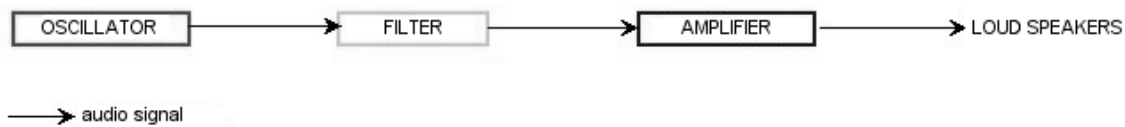

## 6.2 Complementary modules

### 6.2.1 The keyboard

If we hold down a key at this stage, the sound you will get from the speaker will be uniform, without life and without end! In fact, the oscillator delivers a continuous signal (the audio output of a waveform) of a fixed pitch. The only means of stopping this sound that quickly becomes unsupportable is by lowering the filter cut-off frequency so that it becomes more and more thick until it disappears; or more simply, to lower the volume of the amplifier!

- To trigger and stop this sound, at the tone that we want, we use a keyboard, which will be connected to the oscillator. This will “play” as soon as a key is pressed and will mute it as soon as released. Of course, this connection is made through MIDI (it replaces the “gate” type connection of analog synthesizers, which triggers the sound when the key is pressed and stops when released).
- In the second case, so that the sound is correctly tuned with the keyboard notes, we need to apply a key follow modulation (replacing the 1Volt/octave control present on most analog synthesizers).

If you don’t have a keyboard, you can play on the ARP2600 V virtual keyboard.



*The virtual keyboard of the ARP2600 V*

### 6.2.2 The envelope generator

The envelope generator, connected to the amplifier, is used to “sculpt” the form of a sound during a cycle, which begins when we press a note on the keyboard, and ends when we release.



*The envelope module*

The most common envelope modules use 4 settings that we can vary:

- The Attack is the time that the sound will take to reach its maximum volume once the key has been pressed on the keyboard.
- The Decay is the time that the sound will take to decline after the key is played.
- The Sustain is the maximum level of volume that the sound will reach when a key is pressed.
- The Release is the decline time after the key has been released.

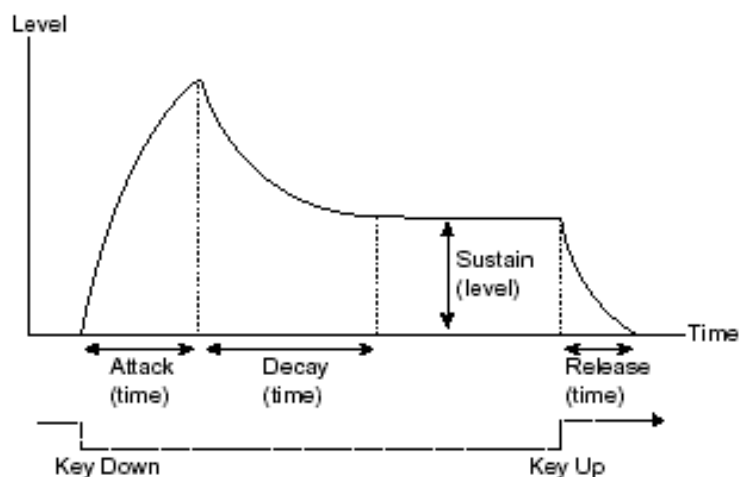

The ARP 2600 V also offers a second simplified envelope (Attack, Release).

The envelope generator can also be used to modulate other settings, like the filter cut-off frequency or the frequency of an oscillator for example.

### 6.2.3 The low frequency oscillator

The LFO (Low Frequency Oscillator) possesses, among other things, the same characteristics as the classic audio-frequency oscillator but does not produce frequencies higher than 20 Hz. In other terms, you won't hear the sound if you connect the audio output of an LFO in an amplifier.

Not being used to produce a sound, it can be used to create a cyclic modulation on the parameter on which it is connected.

On the ARP2600 V, the LFO module is situated on the left of the sequencer .



*The LFO module of the ARP2600 V*

For example:

- ▶ If you connect an LFO to the modulation input of an amplifier, the sound volume will increase and decrease in an alternate manner depending on the speed (the frequency) of this LFO. This will create a tremolo effect.
- ▶ To produce a vibrato effect, simply connect the sinusoid output of an LFO to the modulation input of an oscillator. The frequency of this oscillator will thus be modulated up and then down.
- ▶ Finally, try to connect an LFO output to the modulation input of a lightly resonant low-pass filter and you will obtain a "wah wah" effect.



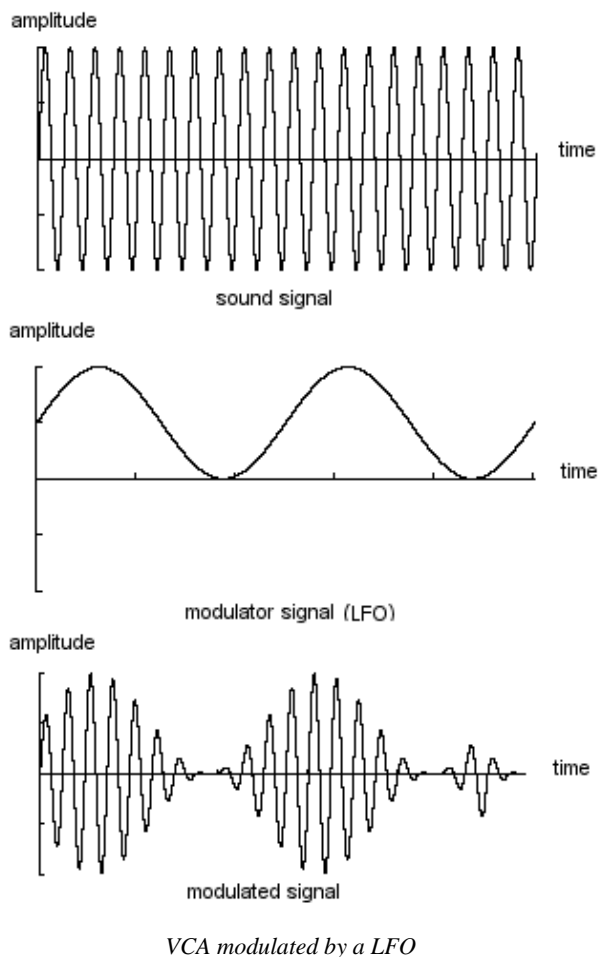

### 6.2.4 The ring modulator

The ring modulator is a module which multiplies two signals (generally two oscillators) so as to generate non-harmonic frequential components. We can thus easily obtain metallic sounds.



*The ring modulator of the ARP2600 V*

### 6.2.5 Sample and hold

The sample and hold module lets us sample the signal connected as input. The values for modulation are taken at every trigger signal connected as input.

This module is notably interesting for creating random modulations by sampling the noise signal.

It is also possible to use it for more rhythmic cyclic modulations by connecting a square or saw-tooth waveform coming from a VCO to the sample and hold input.

The famous sound of R2D2 in Star Wars was created with the sample and hold module on the ARP2600!

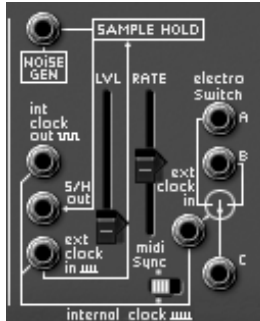

*The sample and hold module of the ARP2600 V*

Now to finish, the scheme of a full synthesizer containing:

- 3 oscillators (VCO)
- 1 noise module
- 1 ring modulator
- 1 sample and hold
- 2 mixers (mix of the 3 VCO, noise and ring modulator towards the filter and the VCA)
- 1 filter (VCF)
- 1 amplifier (VCA, can be placed in stereo space with the pan potentiometers)
- 1 ADSR envelope
- 1 AR envelope

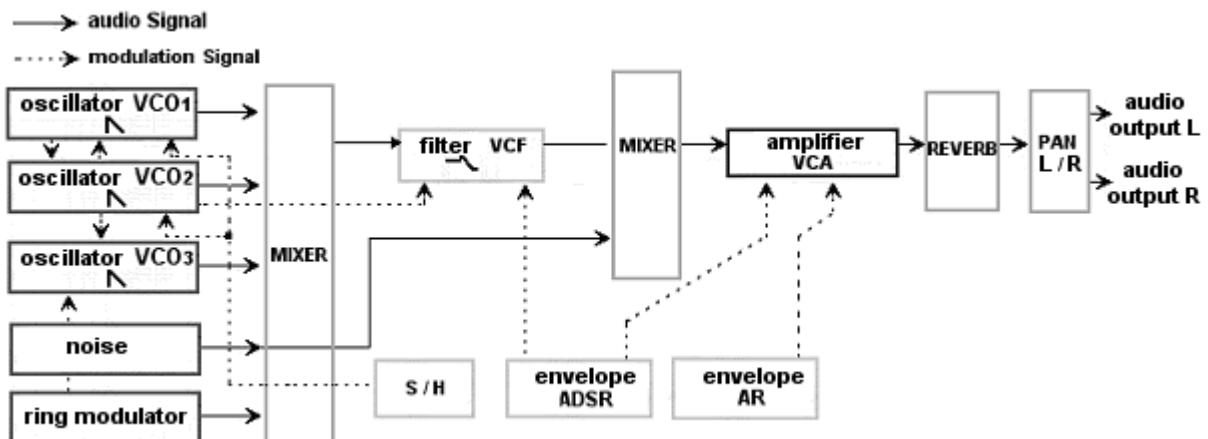

## 7 A FEW ELEMENTS OF SOUND DESIGN

Here is a series of five examples designed to guide you through the creation of a sound and a sequence. They are classed in order of difficulty and organized into two parts:

- The first part will give you an introduction to sound synthesis. For this you will start with the most simple patch (make a VCO oscillator “ring” in a VCA amp going through the filter) and finish by programming of a richer sound (several sources of VCO, VCF filter, VCA, envelopes...)
- The second will take you through every aspect of the sequencer

### 7.1 Simple patch without cabling

To begin, we will look at programming an elementary monophonic sound. It will be composed of four modules:

- two oscillators (VCO1 and 2)
- a low-pass filter (VCF)
- an amplifier (VCA)
- the ADSR envelope connected to the filter

You will thus obtain a basic patch for subtractive synthesis.

Figure 1 shows the different potentiometer positions:

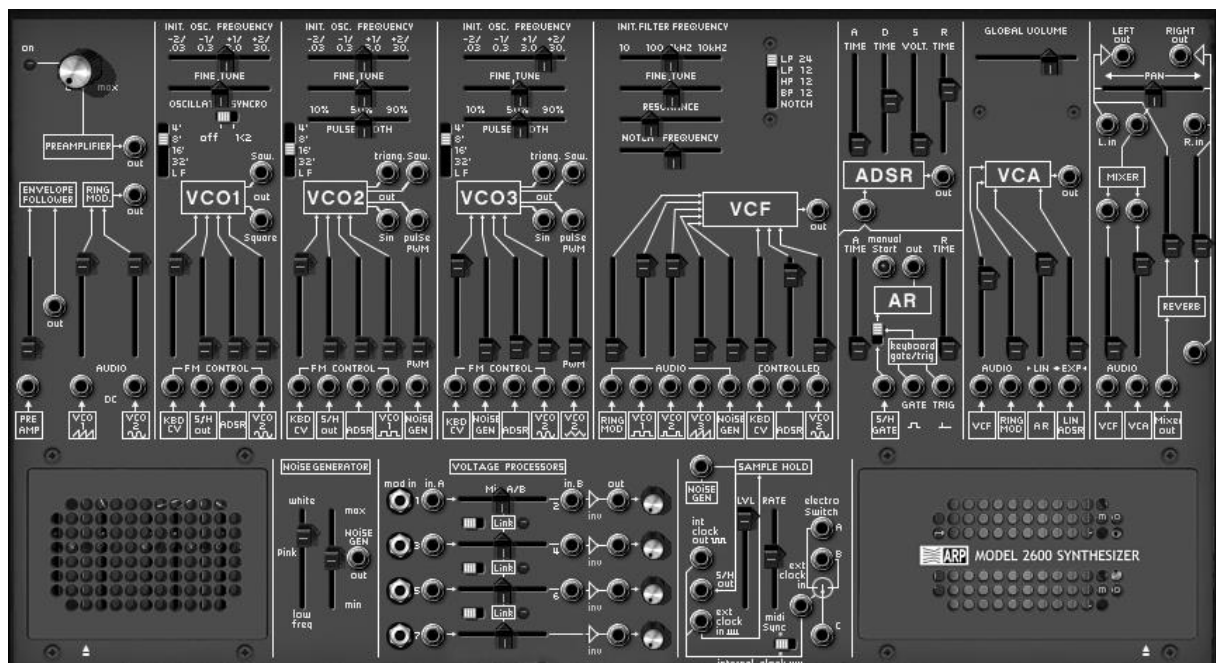

To begin, choose the preset “Temp/ Blank” in the “Template” / “Temp\_Synth” bank. You will notice that no sound is heard when you play a note. Don’t worry, this is normal! Only the volume of the VCA amplifier mixer (the VCF filter output) and the ADSR envelope input of the VCA are open.

- ▶ On the filter module, raise the vertical “VCO1” potentiometer. This is the volume of the first oscillator. When you hold down a note, the sound seems continuous and flat!

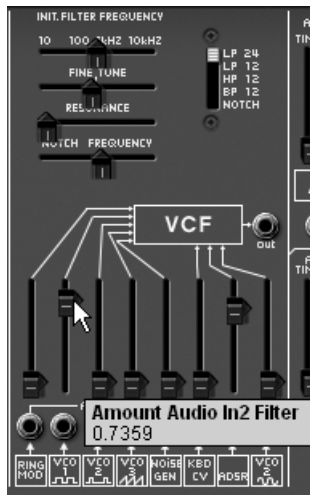

Raise the "VCO1" potentiometer on the filter module

- ▶ To give it more life, still on the same module, raise the "ADSR" potentiometer corresponding to the envelope of the same name.

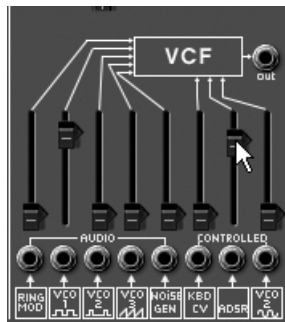

Raise the "ADSR" potentiometer

- ▶ Lower the filter cut-off frequency ("Initial Filter Frequency") potentiometer almost completely so as to really hear the effect produced by the envelope on the filter.

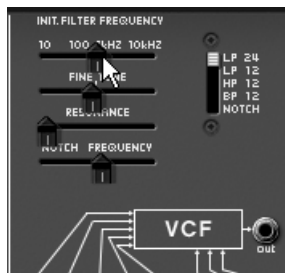

Lower the filter cut-off frequency

- ▶ Lower fully the Sustain potentiometer on the ADSR envelope and lower the Decay a bit as well. (set a value around 100ms). The duration of the sound becomes shorter.



Lower the Decay potentiometer

- ▶ Now raise the volume of “VCO2” on the VCF mixer (“VCO2”). You will hear the 2 oscillators play in unison.

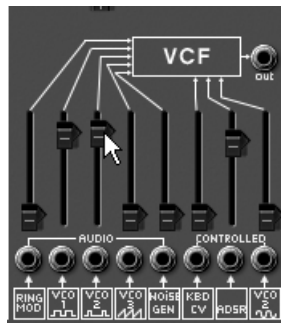

*Raise the volume of VCO2*

- ▶ Lightly detune the second oscillator (“VCO2”). The sound becomes more lively and “fatter”!



*Lightly detune the second oscillator*

- ▶ Set the VCO2 an octave lower: set the “Range” octave selector to “16”.



*Set the “Range” octave selector to “16”*

- ▶ Finally, lightly raise the filter resonance. This will give you a typical 70’s bass sound!

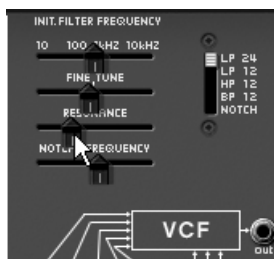

*Raise the filter resonance*

Save this sound as “bass1”, you can reuse it later on. For this, click on the “Save\_as” button and choose the option “new bank” (at the bottom of the menu). Provide a new name to the bank (your initials for example), the sub-bank (“basses” for example) and to the new preset (“Bass1” for example).

## 7.2 Polyphonic patch with cabling

Let's reuse the sound "bass1" as it will be useful to us for the next preset.

We will see how to surpass the limits of the pre-cabled (internal connections between the modules don't need cables). Thanks to this method, you will discover the richness of the ARP2600V2.

This preset contains:

- three oscillators (VCO1, 2 and 3)
  - a low pass filter (VCF)
  - an amplifier (VCA)
  - the ADSR envelope connected to the filter
  - the AR envelope connected to the amplifier
  - a LFO connected to the filter
- Drag a cable from the saw-tooth output on oscillator1 to an audio input of the filter mixer. For this click on the VCO1 "Saw" output and direct the mouse to the "VCO1 square" audio input on the VCF mixer.

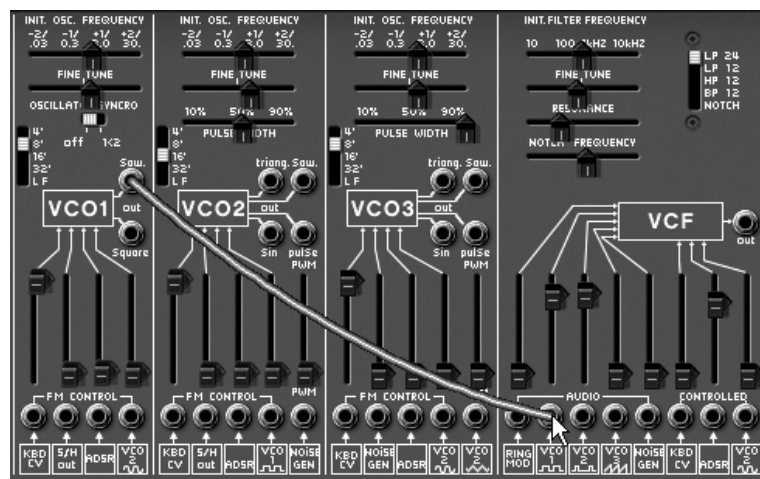

*Direct the "Saw" output to the "VCO1 square" audio input on the VCF mixer*

- Still on this mixer, lower the VCO2 volume. You will notice the change of tone resulting from the change of waveform on VCO1. If you need to be convinced, disconnect the cable (click on the mixer audio input to disconnect the cable). You thus move from a saw-tooth to a square signal. Reconnect the saw-tooth to continue with this preset.
- Do the same with oscillator2: direct the saw-tooth waveform to the VCO2 input on the VCF mixer.
- Still on the same mixer, raise the volume of oscillator3 to complete the base tone. You will hear a sound composed of three oscillators.

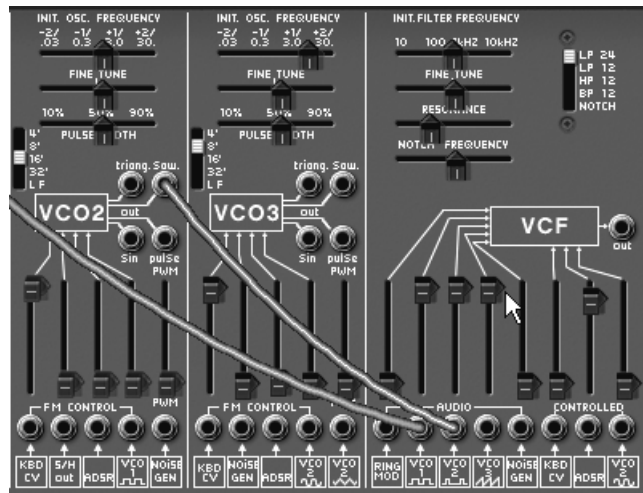

*Raise the volume of oscillator3*

- ▶ Let's apply a variation to the filter cut-off frequency with the LFO. For this, connect the sinus waveform of the "LFO" module (on the left of the "ARP sequencer") to the "control VCO2 sin" modulation input on the VCF. Raise the volume potentiometer for this modulation. The filter cut-off frequency will vary in a cyclic manner.

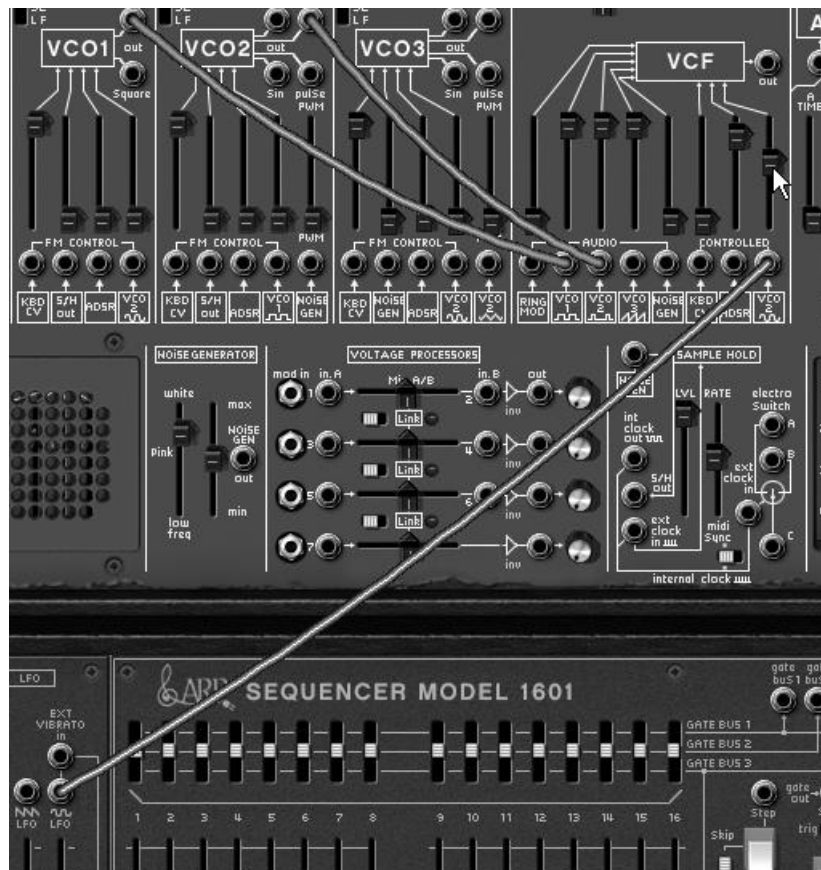

*Raise the volume of the LFO modulation*

- ▶ If it has a tendency to "disappear" too much (you don't hear any more sound), gently raise the cut-off frequency potentiometer.
- ▶ Set the LFO oscillation speed with the "LFO Speed" potentiometer. For this type of sound choose a slow speed (around 0.10 Hz).



*Set the LFO oscillation speed*

- ▶ Raise the Attack time ("A" around 2000 ms) and the Release ("R" around 750ms) of the AR envelope. At last, raise fully the Decay time ("D") of the ADSR envelope. These types of envelopes go better with accompaniment sounds.

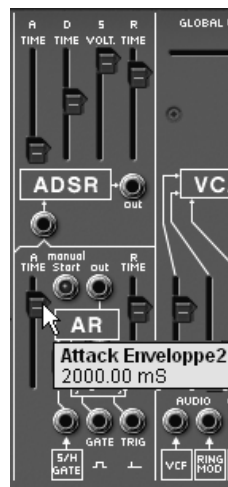

*The envelopes settings*

- ▶ Set the playing mode selector situated on the left of the LFO module to "Poly" (polyphonic) position so as to be able to play chords. Then choose the number of polyphonic voices by clicking on the "voices" button, situated on the toolbar. (For example, choose "6" voices)



*Polyphonic mode*

- ▶ At this stage, you can also enrich your chords by dedicating a third oscillator to sevenths ("+7 semi-tones") - or fifths ("+5 semi-tones").





*Set the third oscillator to sevenths*

- ▶ If you wish to bring more space to your sound, add a delay or chorus effect to it. For this, click on the "Chorus" or "Delay" buttons situated on the toolbar, open the grid on the left of the synthesizer. This holds the settings for these 2 effects. If you use delay, you can synchronize it with the MIDI tempo of your host sequencer.

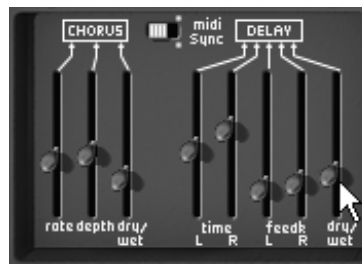

*The "Chorus" and "Delay" settings*

- ▶ Don't forget to save your new sound, as like the previous, it will be useful as a template for other more complicated sounds.

### 7.3 **Special effects patch with the help of the tracking generator**

With this example, you will discover a few of the many possibilities for modulation with the tracking generator / LFO. This module is one of the major additions to the ARP2600 V compared to the original.

Let's again use the "bass1" sound as template for the following preset:

- two oscillators (VCO1 and 2)
- a low pass filter (VCF)
- an amplifier (VCA)
- the tracking generator connected to the filter

We will first see how to create a "complex LFO" modulation type on the filter cut-off frequency with the help of the tracking generator.

- ▶ On the tracking generator module (situated on the bottom right of the synthesizer section), click on the "open tracking" button under this grid to open it. Then, connect the output of the first tracking line ("out") to the "VCO2 Sin" modulation input of the filter.



Open the tracking grid...

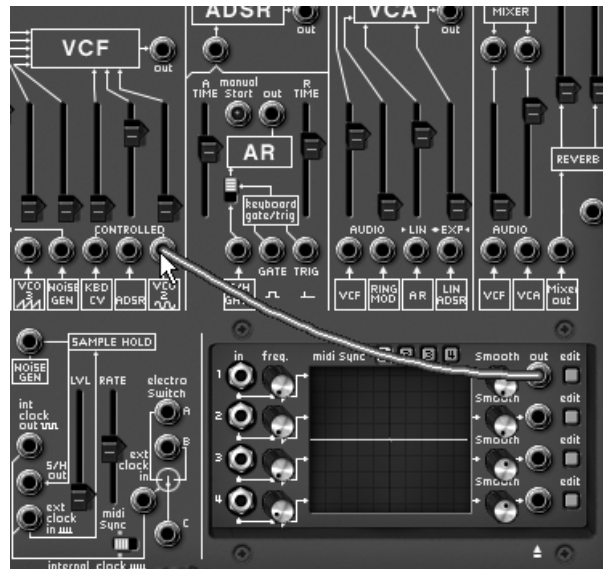

... then, connect the output of the first tracking line to the filter modulation input

- ▶ Raise the potentiometer above the modulation input jack. This is the modulation rate.



The modulation rate

- ▶ Next click on the "edit" button for this tracking line. A secondary window appears. It will allow you to graphically draw the waveform that will modulate the cut-off frequency.



Click on the "edit" button

- ▶ It is composed of three parts: on the left, the selection of the 4 tracking lines, in the middle, the interface for drawing the waveform, and above, the choice of drawing tools.

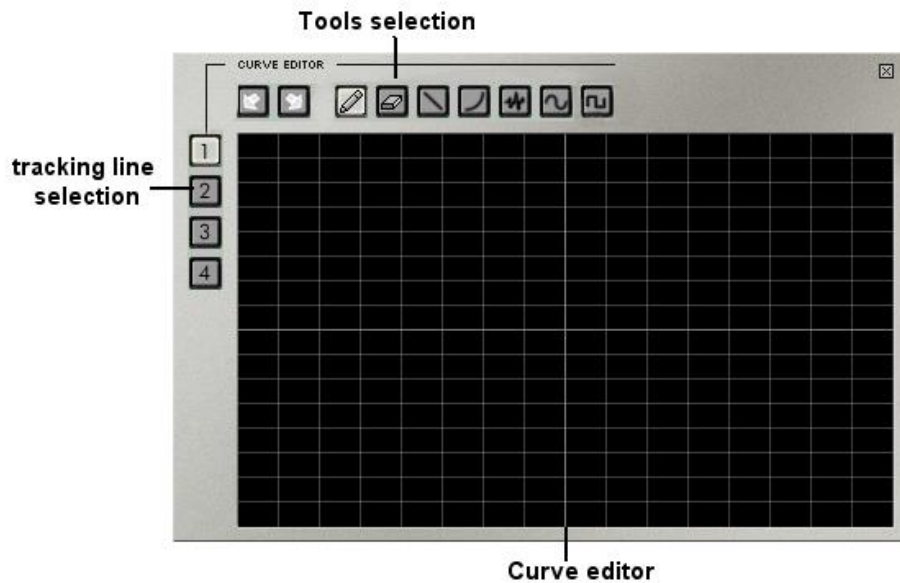

- ▶ By default, the “pencil” tool is selected. Start by drawing a freehand curve. The form is not important. Once this is done, play a note to hear the result of this modulation. You can set the oscillation speed with the “Freq” potentiometer which is on the left of the tracking generator.

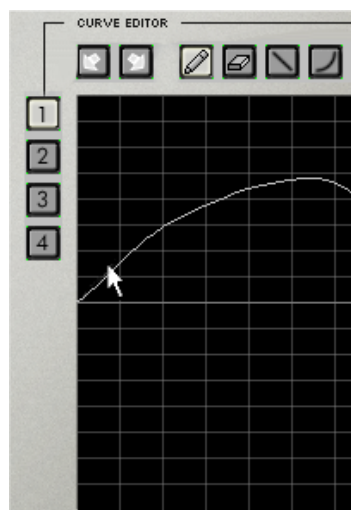

*Drawing a freehand curve*

- ▶ If you wish to modify your curve, return to the editing screen to make changes. The modification is directly taken into account as soon as you click on the edit screen. Nothing stops you from creating several types of curves (freehand, curve, sinus, square, noise...) on a single line. To do this, just use the appropriate tool.
- ▶ You can combine the four tracking lines for a single modulation input. For this, Connect the four tracking generator outputs to the “voltage processor” 1, 2, 3 and 4 inputs.

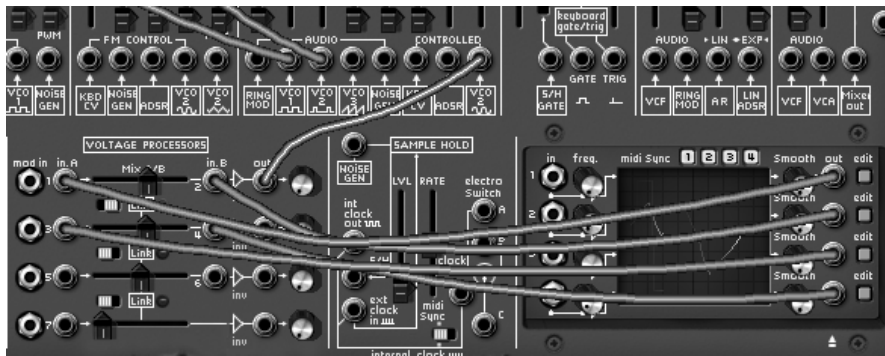

Connect the 4 tracking generator outputs to the "voltage processor" inputs

- ▶ Place the "link A/B" selector switch to the right to link the two lines of mix to the output of the first.



Place the "link A/B" selector switch to the right

- ▶ Of course, the more tracking lines you combine and send to the same destination, the more difficult it becomes to master and hear.

#### 7.4 Patch using the sequencer to create a melody

The ARP sequencer model 1601 was one of the most frequently used sequencers of its time (the 70's). It was added to the ARP2600 V to increase the possibilities for creating melodies and sounds.

The next two examples show how to use the ARP sequencer to create a melody and a sequence of modulation of a synthesis parameter.

For these 2 examples, return to the "bass1" preset. It presents the ideal sound for a melodic sequence or for applying a modulation sequence to the filter cut-off frequency.

The "CV input" is connected directly to the key follow which allows is to trigger a sequence tuned to the note played. The sequencer will automatically start when you play a note.

- ▶ So that your sequence is tuned by following the semi-tones, connect the "Quantized output A" on the sequencer to the input oscillator1 key follow ("VCO1" > "CV KBD").

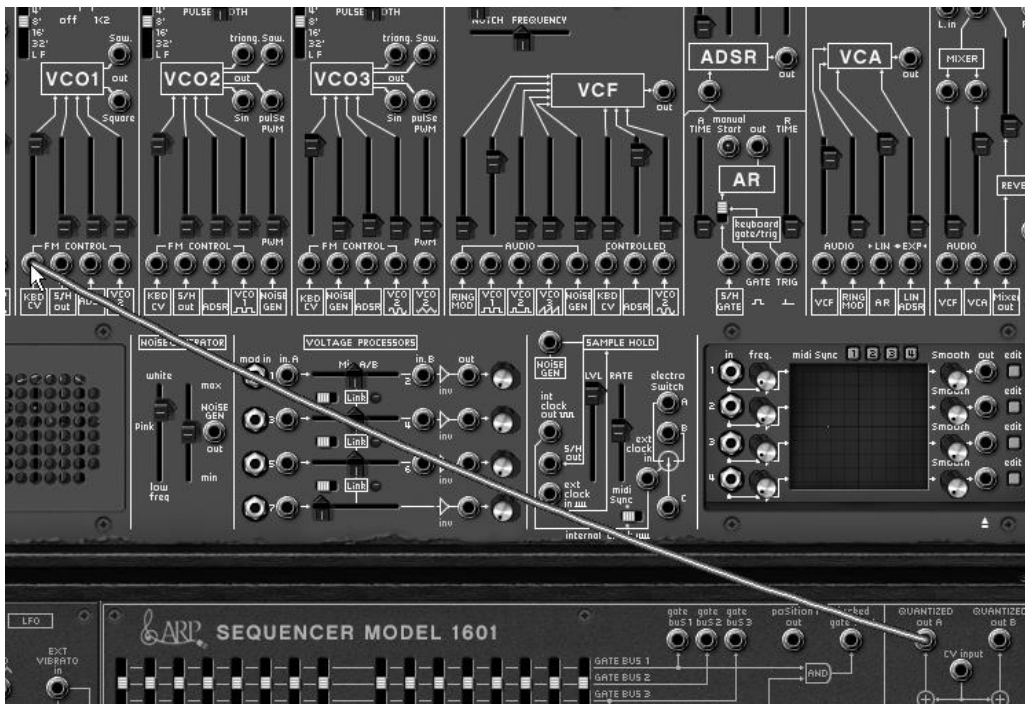

Connect the "Quantized output A" of the sequencer to the KBD CV input oscillator 1

- ▶ Play a note on your keyboard (C4 for example). The sequencer starts and you will hear a series of 16 notes of identical pitch, this is normal.
- ▶ Set each of these 16 potentiometers representing 16 sequence steps to a different value. This will be the melody played in a loop.

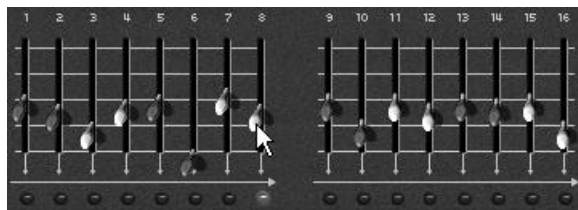

16 sequence steps to a different value

- ▶ You can stop the sequencer by clicking on the "Start/Stop" button.

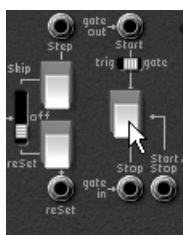

Stop the sequencer by clicking on the "Start/Stop" button

- ▶ It is possible to obtain a sequence of 16 steps like the one you have just created by using 2 independent sequences of 8 steps. For an 8 step sequence, place the "1/16 > 2/8" selector switch to 2/8. The sequencer will only play half of the sequence.



2 independent sequences of 8 steps

- ▶ To play the 16 (or 8) steps randomly, switch the “sequential / random” selector switch to the right (“random”)



*To play the steps randomly*

## 7.5 Patch using the sequencer to create a modulation sequence

Let’s look at creating a sequence of modulation on the filter cut-off frequency.

This will be very useful, notably for special effects such as a “techno” sequence.

Reuse the previous example as a template for this exercise (if you have not created it, go directly to the next step).

- ▶ Connect the sequencer B output to the second modulation input acting on the filter cut-off frequency (ADSR). Raise the potentiometer of the same name to increase the depth of this modulation.

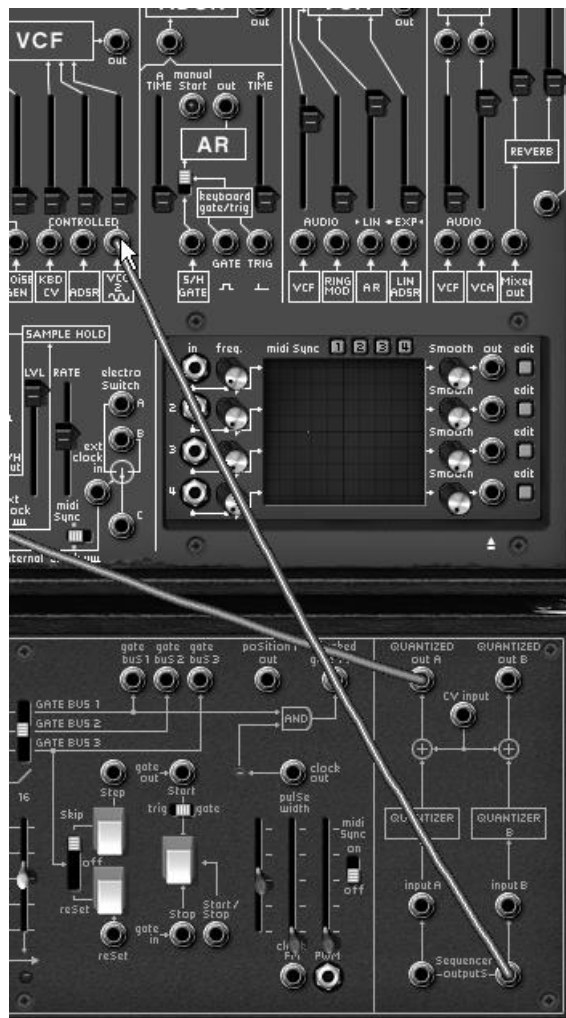

*Connect the sequencer B output to the second modulation input of the filter...*



*...and raise the modulation potentiometer*

- ▶ Play a note on your keyboard to start the sequencer. Change the positions of the 16 potentiometers representing 16 steps in the sequence. You can hear the variations on the opening of the filter cut-off frequency. This creates an automatic wah wah effect.
- ▶ It is also possible to simultaneously create a melodic sequence on the eight first steps and a modulation sequence on the last eight. For this, set the "1/16 > 2/8" interrupter to 2/8. The sequencer will only play half of the sequence.

It is of course possible to connect any other ARP parameter to the sequencer, like the amplifier volume (VCA) for example, the change of waveform width for oscillator square waveform, etc...

These different examples were of varying difficulty. We hope that they will have helped you get to know some of the possibilities offered by the ARP2600V2. But don't hesitate in making your own attempts at programming; this is the best way to progress and find certain originality.

## 8 MODES OF OPERATION

### 8.1 Standalone

The ARP2600 V can be used as an instrument independently from a sequencer software (Standalone mode).

This allows you launch the application as a single instrument, and to play it using an external MIDI keyboard.

#### 8.1.1 Launch the application

To launch the ARP2600 V2 application,

- on Windows, go to the menu Start > Programs > Arturia > ARP2600 V , and choose "ARP2600 V".
- on Macintosh, open the finder > Applications > Arturia and double-click on the ARP2600 V2 application icon.

#### 8.1.2 Configuration of the instrument

Click on the "Settings" button on the ARP 2600 toolbar. It will show the following "Audio MIDI Settings" dialog box.

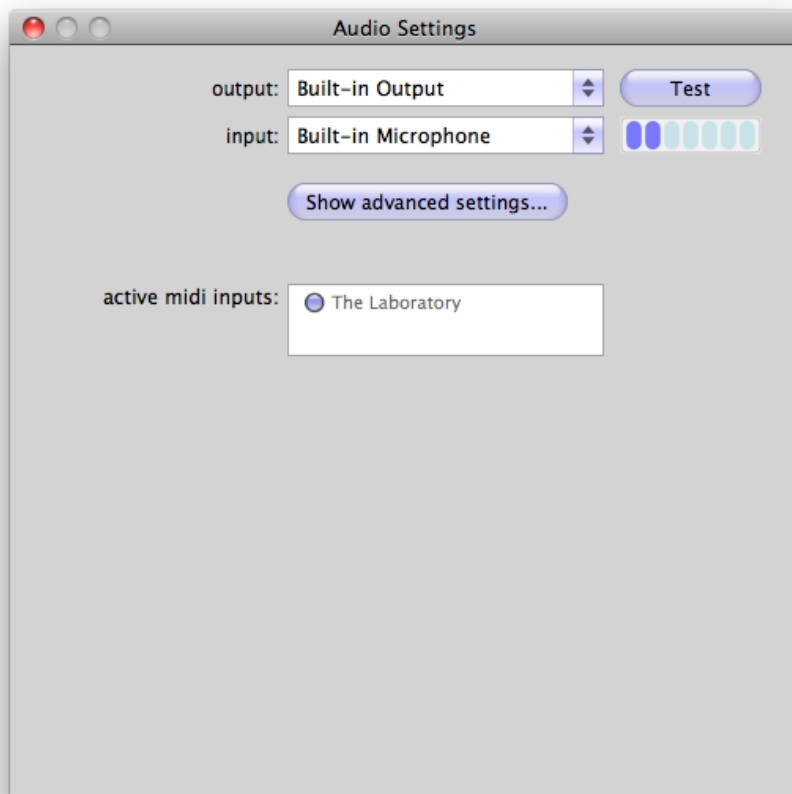



In this option menu you can:

- Set the audio output port
- Choose the audio interface
- Choose memory buffer size (smaller size will increase the load on the CPU but will reduce latency, and reciprocally)
- Choose sample rate between 44100 Hz and 96000 Hz
- Choose one or several active MIDI input port(s)

## **8.2 VST 2**

VST (Virtual Studio Technology) is a plug-in standard created by Steinberg. It allows you to integrate software audio synthesizers and effect plug-ins with audio DAWs and host software. VST is supported by a large number of audio applications like Cubase, Nuendo, Wavelab, FL Studio, Audacity, Samplitude, Sonar, Audition, Live, etc.

The VST interface was updated to version 2 in 1999. One of the additions was the ability for plug-ins to receive MIDI data. This allowed for the introduction of VSTi (Virtual Studio Technology Instrument) format plug-ins.

## **8.3 VST 3**

VST3 is a new update of VST audio plugins protocol. It was updated in 2008. This has improved performance over previous versions of VST and has many new features as well. Cubase 6 and Nuendo 5 are using this new protocol.

With VST3 on Windows, users do not have to choose a folder path to install the plug-in. The installer will put VST3 files automatically into the appropriate directory on your hard drive.

## **8.4 RTAS**

RTAS, short for Real-Time AudioSuite is an audio plug-in developed by Digidesign (AVID technology) for their Pro Tools systems.

## **8.5 AU**

AU for Audio Units is a plug-in protocol developed by Apple Computer. It used by Apple applications such as GarageBand, Soundtrack Pro, Logic Express, Logic Audio, Final Cut Pro, Mainstage, Ardour, Ableton Live, REAPER and Digital Performer.

## **8.6 64 bit compatibility**

The ARP2600 V is optimized for both 32-bit and 64-bit modes. If you have a 64-bit operating system and a 64-bit digital audio workstation, you should use 64-bit version of the plug-in (for Windows).

Usually on 32-bit Windows, all 32-bit programs are installed in C:\Program Files. However on 64-bit Windows, you can find the 64-bit programs in C:\Program Files\ and the 32-bit programs in C:\Program Files (x86)\.

Mac users don't have to bother with this, because the same plug-in file contains both the 32-bit and the 64-bit versions, and the host automatically chooses the better one.

## 8.7 Use in Cubase/Nuendo (VST)

### 8.7.1 Instrument use in VST mode

The opening of the ARP2600 V VST plug-in is the same as opening all other VST plug-ins. Please consult the instruction manual of your host sequencer for more specific information. Under Cubase/Nuendo, create a new "Instrument" track, and choose ARP2600 V in the rack.

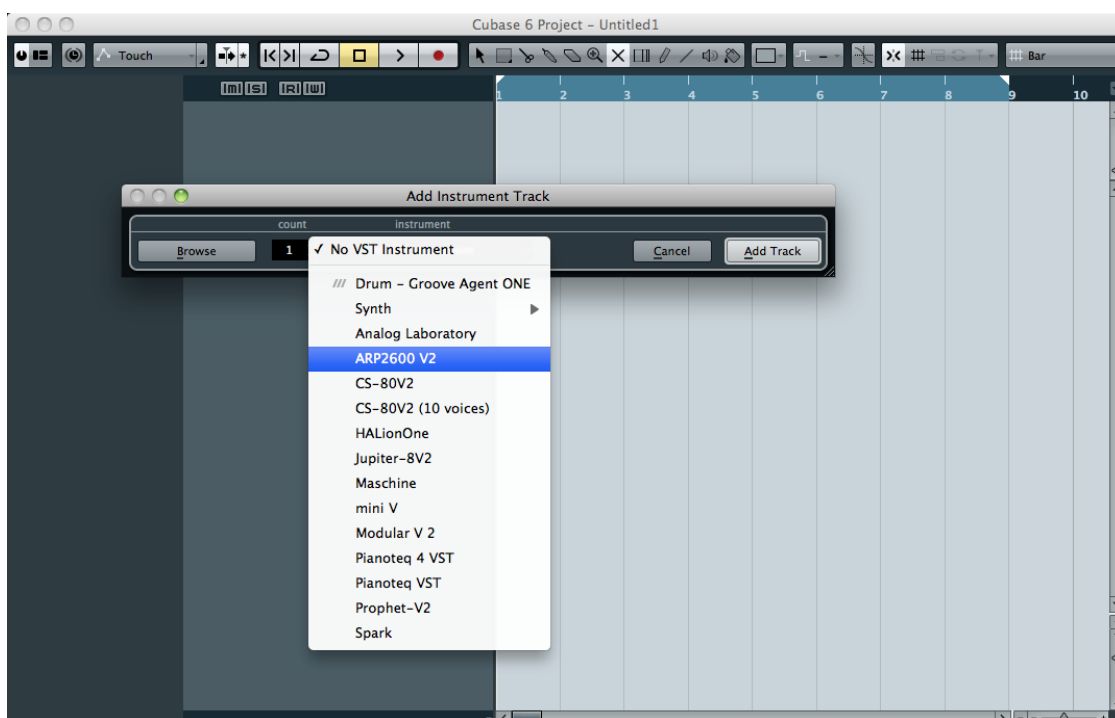
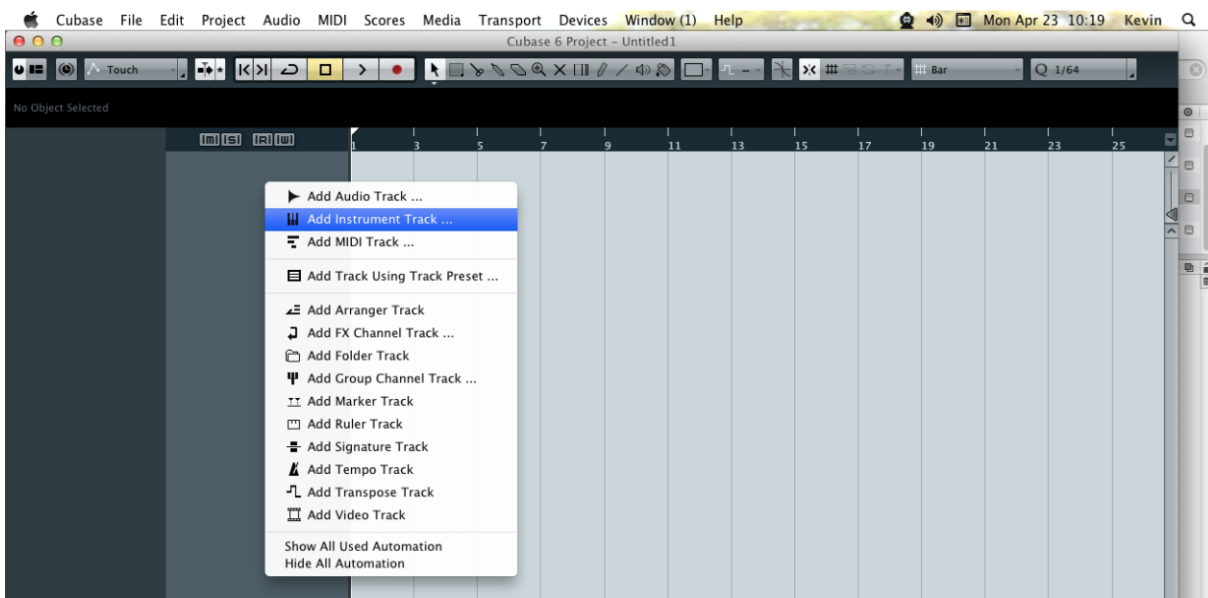

## 8.7.2 Rescan the plug-in directory in Cubase

If the ARP2600 V does not appear in the list of VST plug-ins, you can perform a “rescan” of the plug-in directory.

## 8.7.3 Saving of presets

When the session/project is saved, the ARP2600 V is saved in its last mode of operation, with all modifications intact. For instance, if you were working on a “P1” preset in which you had modified parameters (without saving them as a separate preset within the plug-in itself), the next time you open the project, ARP2600 V will load the “P1” preset plus the modifications you made previously.

The drop-down menu in which the VST sequencer allows you to save a new preset is of course usable with the ARP2600 V. However, it is highly advised to use the ARP2600 V internal menu: the presets saved in this way are usable in any other mode (standalone or with other sequencers), they can be exported and exchanged more easily, and they will remain compatible with the ARP2600 V future versions.

## 8.8 Using in Pro Tools (RTAS)

### 8.8.1 Opening of the plug-in

Access to the ARP2600 V plug-in is like all other plug-ins in Pro Tools, via a new Instrument Track creation:

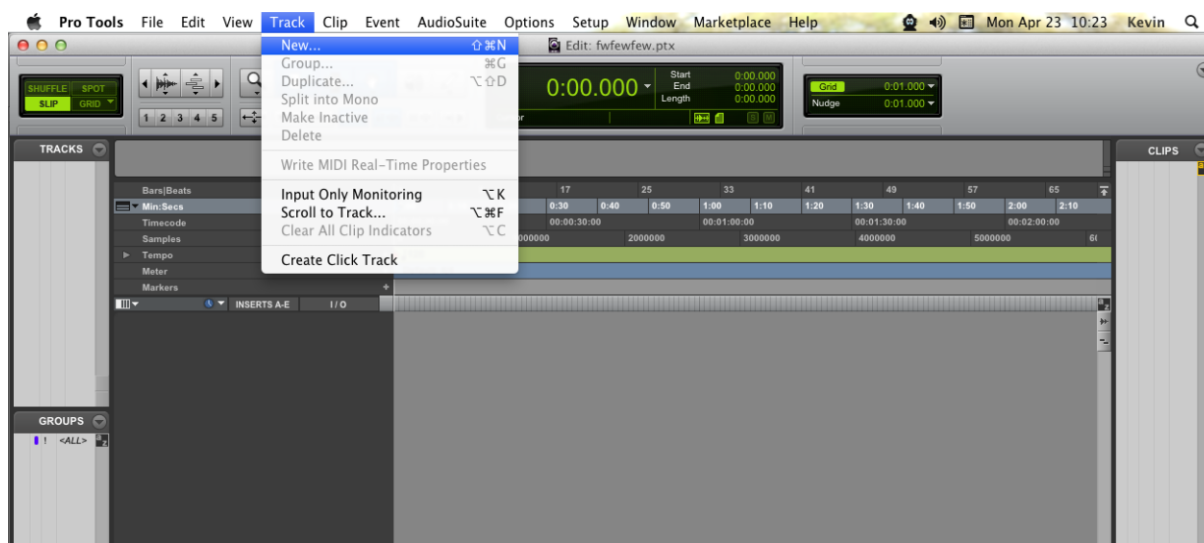

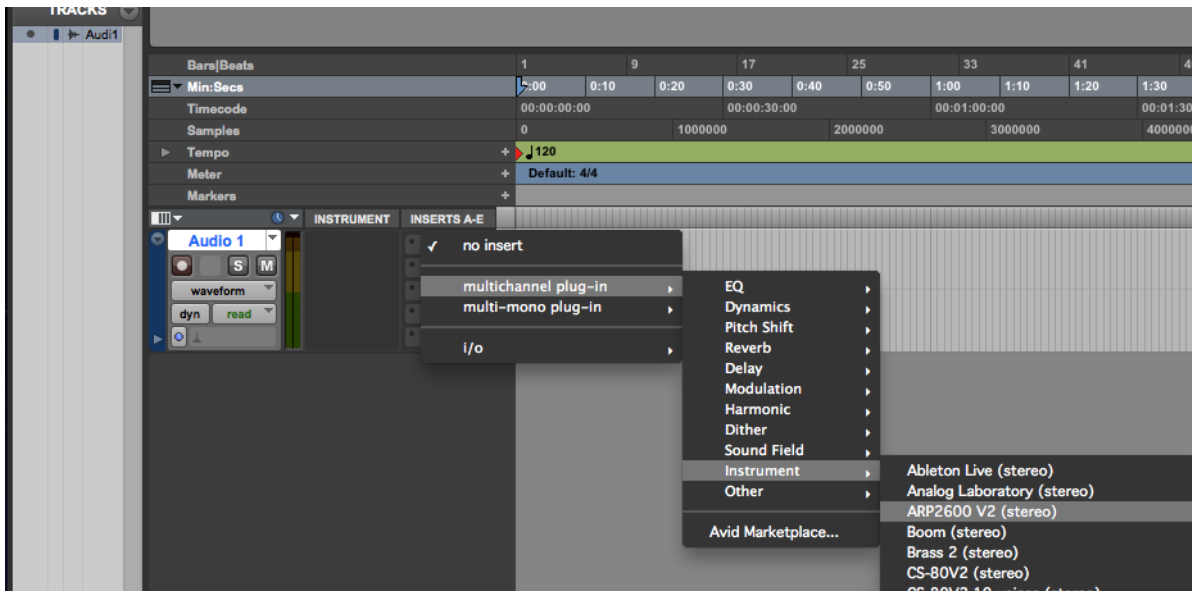

The ARP2600 V must be loaded on an instrument stereo track. We can now make ARP2600 V sound by playing with the mouse on the virtual keyboard.

### 8.8.2 Saving the presets

When the session is saved, the status of ARP2600 V is saved as it is, even if its programming does not correspond to the preset. For example, if you are working on a preset "P1" in which you have modified the parameters (without saving them in the plug-in itself), the next time you open the session, the ARP2600 V will load the "P1" preset plus the modifications you made to it. The "Librarian Menu" of Pro Tools can be used with the ARP2600 V like with all other plug-ins.

Nevertheless it is highly recommended to use the internal ARP2600 V menu: with the presets saved like this, they are usable no matter which mode is chosen (standalone or other sequencer), and they can be exported, exchanged more easily, and will stay compatible with future versions of the ARP2600 V.

### 8.8.3 Automation under Pro Tools

The automation function with ARP2600 V functions like with all RTAS/HTDM plug-ins (check the Pro Tools documentation for more details on plug-in automations).

## 8.9 Using in Logic, Mac OS X (AU)

Make sure the plug-in has been tested OK in the Logic Audio Units Manager. To launch it, click on the menu "Preferences > Start Logic AU Manager".

Create a new Software Instrument track.



On the channel of the mixer corresponding to the selected track, click on the button “I/O” to list the available plug-ins, then select “AU Instruments > Arturia > ARP2600 V2 > Stereo”.

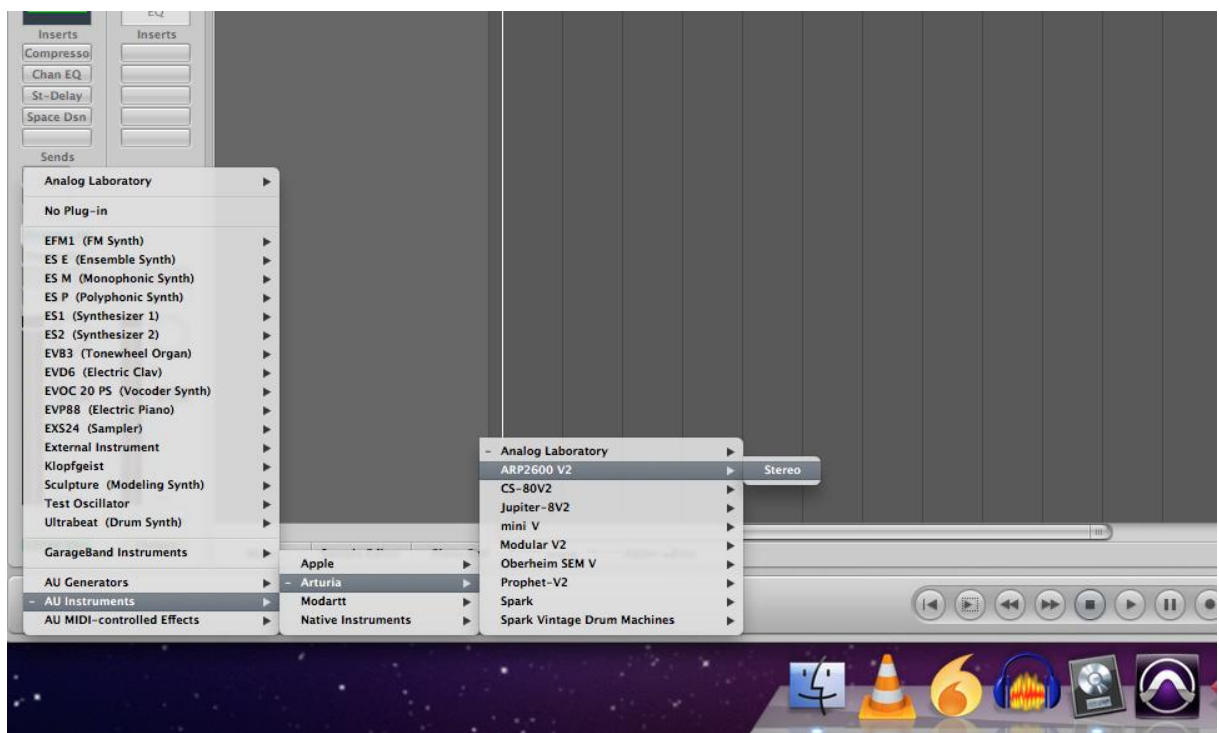

## 8.10 Using in Ableton Live (AU and VST)

From the plug-ins tab, simply double click on the ARP2600 V2 VST or AU icon, or drag-and-drop the plug-in into a MIDI track:

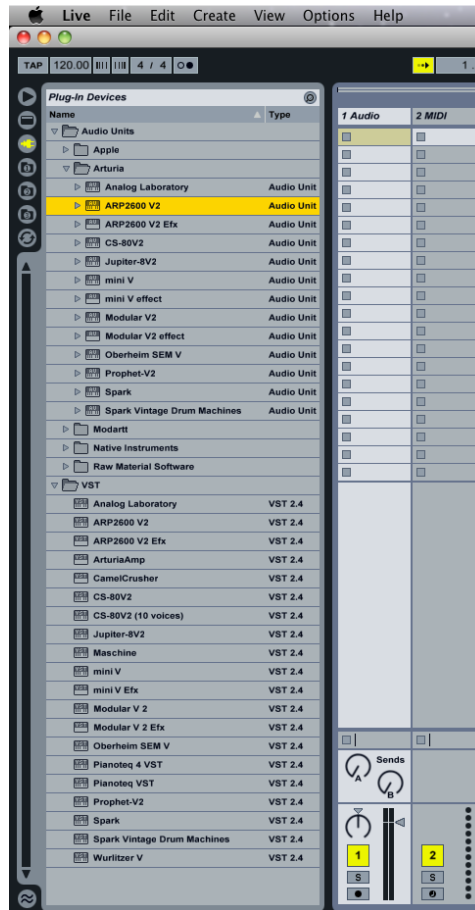

If necessary, you can perform a rescan of the plug-in directory in the Preferences, “File Folder” tab: press the “Scan” button, or press “Scan” while holding the [Alt] key for a full rescan.

# ARP2600V END USER LICENSE AGREEMENT

## 1. General

1.1 In consideration of payment of the Licensee fee, which is a portion of the price you paid, Arturia, as Licensor, grants to you (hereinafter termed "Licensee") a nonexclusive right for the use of software including related media, documentation (for example program descriptions, manuals) and other documents and materials manufactured by Arturia SA ("Product(s)").

All intellectual property rights in the software belong to Arturia SA (hereinafter: "Arturia").

1.2 The following editions of the Product are available: "**Demo**", "**Standard**", "**EDU**" and "**NFR**". Whilst each edition equips the User with the same software, the editions vary as regards both the scope of functions activated in the Product, and the rights of use granted under this EULA.

1.3 By installing the software on your computer you agree to these terms and conditions. If you do not approve these terms and conditions, you must not install this software.

1.4 If you do not approve these terms and conditions, please return the complete Product (including all written matter, packaging and similar material) to the dealer from whom it was originally bought within 14 (fourteen) days after the day of purchase. For purchases from the Arturia Online Store, please contact Arturia on the internet website: [www.arturia.com/support/askforhelp/purchase](http://www.arturia.com/support/askforhelp/purchase).

1.4 Arturia reserves all rights not expressly granted in the EULA.

## 2. Right of use

2.1 The Product is protected by copyright. The Licensee may not lease, loan or sub-license the software. The Licensee is not authorized to modify the software.

2.2 Owning any product provided to the Licensee as "**Standard**" version grants the Licensee a non-exclusive right to use the Product in perpetuity including commercial purposes. The Licensee can activate the Product on up to five computers, as long as only one installation is used at any given time. The Licensee must register the Product to Arturia to get access to client support, and to activate his Product. (An internet connection is required to register and activate the Product, either on the computer on which the Product is installed, either on another device able to exchange files with the computer on which the Product is installed). Owning a license of the Products entitles the Licensee to get access to the future updates of this Product.

2.3 Any Products provided to you as "**NFR**" (Not For Resale) version grants the Licensee a non-exclusive right to use the Product for a limited period of time. The Product shall only be used for demonstration, testing and evaluation purposes. NFR Products must not be used for commercial purposes, and must not be resold or transferred. The Licensee can activate the Product on up to five computers, as long as only one installation is used at any given time. The Licensee must register the

Product to Arturia to get access to client support, and to activate his Product. (An internet connection is required to register and activate the Product, either on the computer on which the Product is installed, either on another device able to exchange files with the computer on which the Product is installed). NFR Products are exempt from update, upgrade or crossgrade offers, and cannot be purchased with or exchanged for vouchers or coupons. Furthermore, as an owner of a NFR Product, you are not entitled to any vouchers that ship with the standard version of the Product.

2.4 Any Products labelled or otherwise provided to you as an **“Educational”** version grants the Licensee a non-exclusive right to use the Product in perpetuity. The Product shall only be used by students or those working in educational institutions. This definition includes students, faculty, staff and administration attending and / or working at an educational institutional facility: private / public schools, colleges, universities and similar. These Products must not be used for commercial purposes, and must not be resold or transferred. The Licensee can activate the Product on up to five computers, as long as only one installation is used at any given time. The Licensee must register the Product to Arturia to get access to client support, and to activate his Product. (An internet connection is required to register and activate the Product, either on the computer on which the Product is installed, either on another device able to exchange files with the computer on which the Product is installed). These Products are exempt from upgrade or crossgrade offers, and cannot be purchased with or exchanged for vouchers or coupons. Furthermore, as an owner of an educational Product, you are not entitled to any vouchers that ship with the standard version of the Product.

2.5 Any Products labelled or otherwise provided to you as a **“Demo”** version grants the Licensee a right to use the Product only for demonstration and evaluation purposes. These Products must not be used for commercial purposes, and must not be resold or transferred. These Products are exempt from upgrade or crossgrade offers, and cannot be exchanged for vouchers or coupons.

### **3. No Unbundling**

Bundles (product bundles are an association of software and hardware or software-only products) can only be resold / transferred as a whole. The individual components of a bundle must not be resold / transferred separately.

### **4. Resell**

4.1 Renting or lending the licensed Software to a third party is expressly forbidden. Apart from that and if not provided otherwise within this EULA.

4.2 Except if otherwise stated within this EULA, Licensee may resell the software to a third party or transfer the software permanently free of charge, provided the third party agrees in writing with this EULA and Licensee ceases all use of the software, completely removes all installed copies of the software from his computers and – if the software was not purchased via download – deletes or transfers the original media delivered with the software to the third party. In addition, Licensee is required to de-register the purchased software with Arturia (more information available on [www.arturia.com](http://www.arturia.com)).

### **5. In case a sound library is part of the purchased Product the following shall apply in addition to the EULA**

The provided samples, instruments and presets can be used for commercial or non-



commercial music and audio Productions without the prior permission from Arturia under the terms of this Agreement. The usage of this Product (in particular samples, instruments and presets) for the creation of a sound library or as a sound library for any kind of synthesizer, virtual instrument, sample library, sample-based Product or other musical instrument is strictly prohibited. Individual samples, sound sets or audio loops may not be distributed (commercially or otherwise) standalone. Furthermore these samples, sound sets or audio may not be repackaged in whole or in part as audio samples, sound libraries or sound effects.

## **6. Data Protection**

Arturia attaches great importance to compliance with legislation on data protection. The User data collected are used exclusively for performing its contractual obligations. No data is passed on to third parties. Further information can be obtained from our Privacy Policy at [www.arturia.com/privacy](http://www.arturia.com/privacy).

## **7. Limited Warranty**

Arturia warrants that the physical media on which the software is provided is free from defects in materials and workmanship under normal use for a period of thirty (30) days from the date of purchase. The Licensee's invoice shall be evidence of the date of purchase. Any implied warranties on the software are limited to thirty (30) days from the date of purchase. Some states do not allow limitations on duration of an implied warranty, so the above limitation may not apply to the Licensee in this case. All programs and accompanying materials are provided "as is".

## **8. No Liability for Consequential Damages**

Neither Arturia nor anyone else involved in the creation, production, or delivery of this Product shall be liable for any direct, indirect, consequential, or incidental damages arising out of the use of, or inability to use this Product (including without limitation, damages for loss of business profits, business interruption, loss of business information and the like) even if Arturia was previously advised of the possibility of such damages. Some states do not allow limitations on the length of an implied warranty or the exclusion or limitation of incidental or consequential damages, so the above limitation or exclusions may not apply to the Licensee in this case. This warranty gives the Licensee specific legal rights, and the Licensee may also have other rights which vary from state to state.