

# **ion**

**Reference Manual**

**ALESIS**

This page intentionally left blank

# Table Of Contents

<b>Introduction .....</b>	<b>7</b>
Welcome!.....	7
<b>Unpacking and Inspection .....</b>	<b>8</b>
<b>How to Use This Manual .....</b>	<b>8</b>
<b>Important Safety Instructions .....</b>	<b>9</b>
<b>Important Safety Instructions (English).....</b>	<b>9</b>
Safety symbols used in this product .....	9
Please follow these precautions when using this product:.....	9
<b>Instructions de Sécurité Importantes</b>	
<b>(French).....</b>	<b>10</b>
Symboles utilisés dans ce produit .....	10
Veuillez suivre ces précautions lors de l'utilisation de	
l'appareil:.....	10
<b>Lesen Sie bitte die folgende</b>	
<b>Sicherheitshinweise (German).....</b>	<b>11</b>
Sicherheit Symbole verwendet in diesem Produkt .....	11
Folgen Sie bitte diesen Vorkehrungen, wenn dieses	
Produkt verwendet wird:.....	11
<b>CE Declaration Of Conformity .....</b>	<b>12</b>
<b>FCC Compliance Statement .....</b>	<b>12</b>
<b>Chapter 1: Connections.....</b>	<b>13</b>
Connecting AC Power .....	13
Making Audio Connections .....	13
Connecting the Foot Pedals.....	13
Connection Diagram.....	14
<b>Chapter 2: Overview .....</b>	<b>15</b>
<b>A Tour of the Front Panel.....</b>	<b>15</b>
The display.....	15
LED functions.....	17
Button functions.....	17
All Notes Off: the [home] button.....	18
Knob functions.....	18
Performance controls .....	18
<b>Chapter 3: Global Parameters.....</b>	<b>19</b>
What does “Global” mean? .....	19
The Global parameters .....	19
LCD Contrast .....	19
Keyboard Curve.....	19
LCD Mode .....	19
Master Tune.....	20
Transpose.....	20
Octave .....	20
MIDI Sync.....	20
Tempo Source .....	21
MIDI Bank Select.....	21
Mod Wheel 2 CC.....	21
Exp Pedal CC.....	21
Exp Pedal Curve.....	22
Arp Send MIDI .....	22

# Table Of Contents

Arp Retrigger .....	22
Analog Drift .....	23
Last Part Enable .....	23
P/M Wheel LEDs .....	23
Pgm Write Protect .....	23
<b>Chapter 4: Parts and Setups .....</b>	<b>25</b>
What is a Setup? .....	25
Programs vs. Parts .....	25
How the Effects are Shared .....	25
Storing a Program or Setup .....	26
Naming a Program or Setup .....	27
Character chart .....	28
Sending a Program or Bank via Sys-Ex .....	29
Special cases .....	30
Sending One Setup or All Setups via Sys-Ex .....	31
Sending All Programs and Setups via Sys-Ex .....	32
Storing and Recalling Setups .....	32
<b>Compare Mode .....</b>	<b>33</b>
<b>Part Parameter Descriptions .....</b>	<b>33</b>
Program Bank .....	33
Program .....	33
MIDI Channel .....	34
MIDI/Local .....	34
Low Key .....	34
High Key .....	34
Out Level .....	35
Out Balance .....	35
EFX Level .....	35
Pan .....	35
Sust Pedal Enable .....	36
Exp Pedal Enable .....	36
Pitch Wheel Enable .....	36
Mod 1 Wheel Enable .....	36
Mod 2 Wheel Enable .....	37
Transpose .....	37
Octave .....	37
<b>Chapter 5: Program Parameters .....</b>	<b>39</b>
<b>How the Ion Makes Sound .....</b>	<b>39</b>
The Oscillators .....	39
The Pre Filter Mix .....	39
The Filters .....	39
The Post Filter Mix .....	40
Output .....	40
Signal Flow Diagram .....	40
<b>Modulation .....</b>	<b>41</b>
The LFOs .....	41
The Envelopes .....	41
<b>Program Parameter Descriptions .....</b>	<b>42</b>
Voice: the [unison] button .....	42
Voice [edit]: Unison voices .....	42
Voice [edit]: Unison detune .....	42
Voice [edit]: P Wheel mode .....	43

Voice: the [porta] button .....	43
Voice [edit]: Portamento type .....	43
Voice [edit]: Portamento time .....	44
Voice [edit]: Portamento trigger .....	44
Voice: the [mono/poly] button .....	44
LFO [edit]: Rate .....	44
LFO [edit]: Sync .....	45
LFO [edit]: Reset .....	45
LFO [edit]: M1 to LFOx .....	46
LFO: the [1] button .....	46
LFO: the [2] button .....	46
LFO: the [s&h] button .....	46
<b>Sample &amp; Hold (S&amp;H) .....</b>	<b>47</b>
S&H [edit]: Rate .....	47
S&H [edit]: Sync .....	47
S&H [edit]: Input .....	47
S&H [edit]: Reset .....	49
S&H [edit]: Smoothing .....	49
<b>Tempo .....</b>	<b>49</b>
Tempo: the [tap] button .....	49
<b>The Arpeggiator .....</b>	<b>50</b>
Arp [edit]: Pattern .....	50
Arp [edit]: Length .....	50
Arp [edit]: Octave Range .....	50
Arp [edit]: Octave Span .....	51
Arp [edit]: Note Order .....	51
Arp [edit]: Tempo Multiplier .....	52
Arp [edit]: Program Tempo .....	52
Arp: the [on] button .....	52
Arp: the [latch] button .....	52
<b>The Oscillators .....</b>	<b>53</b>
Osc [edit]: Waveform .....	53
Osc [edit]: Shape .....	53
Osc [edit]: Octave .....	54
Osc [edit]: Pitch Semitone .....	54
Osc [edit]: Pitch Fine Tune .....	54
Osc [edit]: Pitch Wheel Range .....	55
Osc 1 [edit]: FM Level .....	55
Osc 1 [edit]: FM Type .....	55
Osc 1 [edit]: FM Config .....	56
Osc 1 [edit]: Sync Osc .....	56
Osc 1 [edit]: Sync Type .....	56
Osc 1: the [osc sync] button .....	57
<b>The Pre Filter section .....</b>	<b>57</b>
Pre Filter Mix [edit]: Osc 1 Level .....	57
Pre Filter Mix [edit]: Osc 2 Level .....	57
Pre Filter Mix [edit]: Osc 3 Level .....	57
Pre Filter Mix [edit]: Ring Mod Level .....	57
Pre Filter Mix [edit]: External Input Level .....	58
Pre Filter Mix [edit]: Noise Level .....	58
Pre Filter Mix [edit]: Osc 1 Balance .....	58
Pre Filter Mix [edit]: Osc 2 Balance .....	58
Pre Filter Mix [edit]: Osc 3 Balance .....	59
Pre Filter Mix [edit]: Ring Mod Balance .....	59

# Table Of Contents

Pre Filter Mix [edit]: External Input Balance.....	59
Pre Filter Mix [edit]: Noise Balance.....	59
Pre Filter Mix [edit]: Noise Type.....	60
Pre Filter Mix [edit]: f1 -> f2 Level.....	60
<b>The Filters .....</b>	<b>60</b>
Filter [edit]: Type.....	60
Filter [edit]: Frequency.....	62
Filter 2: the [offset] button.....	62
Filter [edit]: Resonance.....	62
Filter [edit]: Key Track.....	63
Filter [edit]: Envelope Amount.....	63
<b>The Post Filter Mix section .....</b>	<b>63</b>
Post Filter Mix [edit]: Filter 1 Level.....	63
Post Filter Mix [edit]: Filter 2 Level.....	63
Post Filter Mix [edit]: Pre Filter Level.....	63
Post Filter Mix [edit]: Filter 1 Pan.....	64
Post Filter Mix [edit]: Filter 2 Pan.....	64
Post Filter Mix [edit]: Pre Filter Pan.....	64
Post Filter Mix [edit]: Filter 1 Polarity.....	64
Post Filter Mix [edit]: Pre Filter Signal.....	64
<b>The Output section.....</b>	<b>65</b>
Output [edit]: Drive Type.....	65
Output [edit]: Drive Level.....	65
Output [edit]: Effects Send Level.....	66
Output [edit]: Program Level.....	66
<b>The Envelopes .....</b>	<b>66</b>
Env [edit]: Attack Time.....	66
Env [edit]: Attack Slope.....	67
Env [edit]: Decay Time.....	67
Env [edit]: Decay Slope.....	67
Env [edit]: Sustain Level.....	68
Env [edit]: Sustain Time.....	68
Env [edit]: Release Time.....	69
Env [edit]: Release Slope.....	69
Env [edit]: Keyboard Velocity Track.....	69
Env [edit]: Reset.....	70
Env [edit]: Freerun.....	70
Env [edit]: Loop.....	71
Env [edit]: Sustain Pedal.....	72
<b>Chapter 6: The Mod Matrix.....</b>	<b>73</b>
What is the Mod Matrix?.....	73
<b>Mod Matrix Parameter Descriptions .....</b>	<b>73</b>
Mod Select.....	73
Mod Source.....	74
Mod Destination.....	75
Mod Level.....	77
Mod Offset.....	77
<b>Tracking Generator .....</b>	<b>78</b>
Tracking Point.....	78
Level.....	78
# of Points.....	78
Tracking Input.....	79

<b>Chapter 7: Effects .....</b>	<b>81</b>
<b>Master Effects .....</b>	<b>81</b>
Effect Type .....	81
Effect Mix .....	81
Parameters A-F .....	81
<b>Effect Types.....</b>	<b>81</b>
Bypass.....	81
Super Phaser.....	82
String Phaser .....	83
Theta Flanger .....	84
Thru Zero Flanger .....	85
Chorus.....	86
40-Band Vocoder.....	87
<b>Chapter 8: MIDI .....</b>	<b>89</b>
<b>What is MIDI? .....</b>	<b>89</b>
MIDI Connections.....	89
Using Your Ion With a MIDI Sequencer .....	91
Changing the MIDI Channel.....	91
Local vs. MIDI Control.....	92
Saving Programs and Setups via MIDI.....	93
Loading Programs and Setups via MIDI.....	94
Updating Software Via MIDI.....	95
Sending and Receiving Bank Select Messages .....	95
All Notes Off.....	95
MIDI Controller Numbers .....	96
MIDI Implementation Chart.....	97
<b>Appendix A: Frequently Asked Questions ...</b>	<b>99</b>
How do I split/layer the keyboard?.....	99
What is a MIDI Sequence? .....	99
Where can I get more Banks?.....	99
Are Ion Programs compatible with Andromeda programs? .....	99
How do I change what the (m2) wheel does?.....	99
<b>Appendix B: Troubleshooting .....</b>	<b>101</b>
Recovering from a Crash.....	102
Checking the Software Version .....	102
Cleaning Your Ion .....	102
<b>Specifications .....</b>	<b>103</b>
Sound Engine.....	103
Audio Input .....	103
Audio Output.....	103
Audio Performance .....	103
Physical.....	103
<b>Warranty/Contact Alesis.....</b>	<b>105</b>
Alesis Limited Warranty .....	105
Alesis Contact Information .....	105





# Introduction

## Welcome!

Congratulations on your purchase of the Ion, Alesis's 8-voice Analog Modeling synthesizer! It's a powerful instrument, and we're sure you will find it exciting to use!

Since the dawn of digital synthesizer technology and the subsequent decline in the number of manufacturers producing analog synthesizers, companies have been offering an increasing number of products with features and sounds that emulate the functional and sonic behavior of analog synthesizers. Here at Alesis, being the company responsible for producing the A6 Andromeda, arguably the most powerful analog synthesizer ever released, we think we're in the best position to produce an analog modeling synthesizer that most closely resembles the real thing!

Be sure to register your Ion at the Alesis website, [www.alesis.com](http://www.alesis.com). And since the Ion's operating system is upgradeable via MIDI, you will want to check the site once in a while for updates. We may well add new features in later versions of the Ion's software. We plan to have additional program banks there as well, so keep checking back with us!

We hope your investment will bring you many years of creative enjoyment and help you achieve your goals.

Sincerely,  
The people of Alesis

## Unpacking and Inspection

The shipping carton for your Ion should contain the following items:

- An Ion
- AC power cable
- This instruction manual
- A warranty card

Please log on to the Alesis website at [www.alesis.com](http://www.alesis.com) to register your new Ion synthesizer. This will help us give you the best support we possibly can.

## How to Use This Manual

We're sure you'd like to jump in and start using your Ion synthesizer quickly. To help you do this, refer to Chapter 1 for hook-up instructions, and then read Chapter 2 "Overview." This will get you playing in no time. If you have any questions, refer to the Frequently Asked Questions in Appendix A on page 99.

Basic configuration issues will be found in Chapter 3 "Global Parameters."

The "housekeeping" functions of the Ion, such as the process of storing a Program, are covered in Chapter 4 "Parts and Setups." There is also important MIDI information regarding Setups in this chapter.

If you want to create your own sounds from the ground up or learn what a particular knob or button does, refer to Chapters 5 through 7. Each parameter is covered in detail.

For more specific information on how to use the Ion with MIDI, refer to Chapter 8 "MIDI."

Near the end of the manual are troubleshooting tips and specifications.

The names for all buttons, knobs, and wheels on the Ion are formatted throughout the manual so as to be easily identified. Here are some examples:

- |                    |   |
|--------------------|---|
| <b>Voice</b>       | The names for the bracketed, "red letter" sections of the front panel are shown capitalized and in bold type. |
| Soft buttons       | The round buttons under the display are capitalized.  |
| <b>[unison]</b>    | The front panel buttons are bracketed and lower case.   |
| <b>(m1)</b>        | Names for the wheels and pedals are in parentheses.   |
| <b>ext input</b>   | The audio input/output jacks are in lower case letters.   |
| <b>attack</b>      | The knobs are represented in lower case letters also.   |
| <b>mod or loop</b> | Dedicated LEDs are also offset in bold type.  |

*Helpful tips and advice are highlighted in a shaded box like this.*

 *When something important appears in the manual, an exclamation mark (like the one shown at left) will appear with some explanatory text.*

# Important Safety Instructions

## Important Safety Instructions (English)

### Safety symbols used in this product



This symbol alerts the user that there are important operating and maintenance instructions in the literature accompanying this unit.



This symbol warns the user of uninsulated voltage within the unit that can cause dangerous electric shocks.



This symbol warns the user that output connectors contain voltages that can cause dangerous electrical shock.

### Please follow these precautions when using this product:



1. Read these instructions.
2. Keep these instructions.
3. Heed all warnings.
4. Follow all instructions.
5. Do not use this apparatus near water.
6. Clean only with a damp cloth. Do not spray any liquid cleaner onto the faceplate, as this may damage the front panel controls or cause a dangerous condition.
7. Install in accordance with the manufacturer's instructions.
8. Do not install near any heat sources such as radiators, heat registers, stoves, or other apparatus (including amplifiers) that produce heat.
9. Do not defeat the safety purpose of the polarized or grounding-type plug. A polarized plug has two blades with one wider than the other. A grounding-type plug has two blades and a third grounding prong. The wide blade or the third prong are provided for your safety. When the provided plug does not fit into your outlet, consult an electrician for replacement of the obsolete outlet.
10. Protect the power cord from being walked on or pinched, particularly at plugs, convenience receptacles, and the point where they exit from the apparatus.
11. Use only attachments or accessories specified by the manufacturer.
12. Use only with a cart, stand, bracket, or table designed for use with professional audio or music equipment. In any installation, make sure that injury or damage will not result from cables pulling on the apparatus and its mounting. If a cart is used, use caution when moving the cart/apparatus combination to avoid injury from tip-over.
13. Unplug this apparatus during lightning storms or when unused for long periods of time.
14. Refer all servicing to qualified service personnel. Servicing is required when the apparatus has been damaged in any way, such as when the power-supply cord or plug is damaged, liquid has been spilled or objects have fallen into the apparatus, the apparatus has been exposed to rain or moisture, does not operate normally, or has been dropped.
15. This unit produces heat when operated normally. Operate in a well-ventilated area with at least six inches of clearance from peripheral equipment.
16. This product, in combination with an amplifier and headphones or speakers, may be capable of producing sound levels that could cause permanent hearing loss. Do not operate for a long period of time at a high volume level or at a level that is uncomfortable. If you experience any hearing loss or ringing in the ears, you should consult an audiologist.
17. Do not expose the apparatus to dripping or splashing. Do not place objects filled with liquids (flower vases, soft drink cans, coffee cups) on the apparatus.
18. **WARNING:** To reduce the risk of fire or electric shock, do not expose this apparatus to rain or moisture.



## Instructions de Sécurité Importantes (French)

### Symboles utilisés dans ce produit



Ce symbole alerte l'utilisateur qu'il existe des instructions de fonctionnement et de maintenance dans la documentation jointe avec ce produit.



Ce symbole avertit l'utilisateur de la présence d'une tension non isolée à l'intérieur de l'appareil pouvant engendrer des chocs électriques.



Ce symbole prévient l'utilisateur de la présence de tensions sur les raccordements de sorties, représentant un risque d'électrocution.

### Veillez suivre ces précautions lors de l'utilisation de l'appareil:



1. Lisez ces instructions.
2. Gardez ces instructions.
3. Tenez compte de tous les avertissements.
4. Suivez toutes les instructions.
5. N'utilisez pas cet appareil à proximité de l'eau.
6. Ne nettoyez qu'avec un chiffon humide. Il est potentiellement dangereux d'utiliser des pulvérisateurs ou nettoyeurs liquides sur cet appareil.
7. Installez selon les recommandations du constructeur.
8. Ne pas installer à proximité de sources de chaleur comme radiateurs, cuisinière ou autres appareils (dont les amplificateurs) produisant de la chaleur.
9. Ne pas enlever la prise de terre du cordon secteur. Une prise murale avec terre deux broches et une troisième reliée à la terre. Cette dernière est présente pour votre sécurité. Si le cordon secteur ne rentre pas dans la prise de courant, demandez à un électricien qualifié de remplacer la prise.
10. Évitez de marcher sur le cordon secteur ou de le pincer, en particulier au niveau de la prise, et aux endroits où il sort de l'appareil.
11. N'utilisez que des accessoires spécifiés par le constructeur.
12. N'utilisez qu'avec un stand, ou table conçus pour l'utilisation d'audio professionnel ou instruments de musique. Dans toute installation, veillez de ne rien endommager à cause de câbles qui tirent sur des appareils et leur support.
13. Débranchez l'appareil lors d'un orage ou lorsqu'il n'est pas utilisé pendant longtemps.
14. Faites réparer par un personnel qualifié. Une réparation est nécessaire lorsque l'appareil a été endommagé de quelque sorte que ce soit, par exemple lorsque le cordon secteur ou la prise sont endommagés, si du liquide a coulé ou des objets se sont introduits dans l'appareil, si celui-ci a été exposé à la pluie ou à l'humidité, ne fonctionne pas normalement ou est tombé.
15. Puisque son fonctionnement normal génère de la chaleur, placez cet appareil au moins 15cm. des équipements périphériques et assurez que l'emplacement permet la circulation de l'air.
16. Ce produit, utilisé avec un amplificateur et un casque ou des enceintes, est capable de produire des niveaux sonores pouvant engendrer une perte permanente de l'ouïe. Ne l'utilisez pas pendant longtemps à un niveau sonore élevé ou à un niveau non confortable. Si vous remarquez une perte de l'ouïe ou un bourdonnement dans les oreilles, consultez un spécialiste.
17. N'exposez pas l'appareil à l'égouttement ou à l'éclaboussure. Ne placez pas les objets remplis de liquides (vases à fleur, boîtes de boisson non alcoolique, tasses de café) sur l'appareil.
18. **AVERTISSEMENT:** Pour réduire le risque du feu ou de décharge électrique, n'exposez pas cet appareil à la pluie ou à l'humidité.



## Lesen Sie bitte die folgende Sicherheitshinweise (German)

### Sicherheit Symbole verwendet in diesem Produkt



Dieses Symbol alarmiert den Benutzer, daß es wichtige Funktionieren und Wartung Anweisungen in der Literatur gibt, die diese Maßeinheit begleitet.



Dieses Symbol warnt den Benutzer der nicht isolierten Spannung innerhalb der Maßeinheit, die gefährliche elektrische Schläge verursachen kann.



Dieses Symbol warnt den Benutzer, dem Ausgabestecker Spannungen enthalten, die gefährlichen elektrischen Schlag verursachen können.

### Folgen Sie bitte diesen Vorkehrungen, wenn dieses Produkt verwendet wird:



1. Lesen Sie die Hinweise.
2. Halten Sie sich an die Anleitung.
3. Beachten Sie alle Warnungen.
4. Beachten Sie alle Hinweise.
5. Bringen Sie das Gerät nie mit Wasser in Berührung.
6. Verwenden Sie zur Reinigung nur ein weiches Tuch. Verwenden Sie keine flüssigen Reinigungsmittel. Dies kann gefährliche Folgen haben.
7. Halten Sie sich beim Aufbau des Gerätes an die Angaben des Herstellers.
8. Stellen Sie das Gerät nicht in der Nähe von Heizkörpern, Heizungsklappen oder anderen Wärmequellen (einschließlich Verstärkern) auf.
9. Verfehlen Sie nicht den Zweck des grounding Terminals auf dem Netzstecker. Dieses Terminal wird für Ihre Sicherheit zur Verfügung gestellt.
10. Verlegen Sie das Netzkabel des Gerätes niemals so, daß man darüber stolpern kann oder daß es gequetscht wird.



11. Benutzen Sie nur das vom Hersteller empfohlene Zubehör.
12. Verwenden Sie ausschließlich Wagen, Ständer, oder Tische, die speziell für professionelle Audio- und Musikinstrumente geeignet sind. Achten Sie immer darauf, daß die jeweiligen Geräte sicher installiert sind, um Schäden und Verletzungen zu vermeiden. Wenn Sie einen Rollwagen benutzen, achten Sie darauf, das dieser nicht umkippt, um Verletzungen auszuschließen.
13. Ziehen Sie während eines Gewitters oder wenn Sie das Gerät über einen längeren Zeitraum nicht benutzen den Netzstecker aus der Steckdose.



14. Die Wartung sollte nur durch qualifiziertes Fachpersonal erfolgen. Die Wartung wird notwendig, wenn das Gerät beschädigt wurde oder aber das Stromkabel oder der Stecker, Gegenstände oder Flüssigkeit in das Gerät gelangt sind, das Gerät dem Regen oder Feuchtigkeit ausgesetzt war und deshalb nicht mehr normal arbeitet oder heruntergefallen ist.
15. Dieses Gerät produziert auch im normalen Betrieb Wärme. Achten Sie deshalb auf ausreichende Lüftung mit mindestens 15 cm Abstand von anderen Geräten.
16. Dieses Produkt kann in Verbindung mit einem Verstärker und Kopfhörern oder Lautsprechern Lautstärkepegel erzeugen, die anhaltende Gehörschäden verursachen. Betreiben Sie es nicht über längere Zeit mit hoher Lautstärke oder einem Pegel, der Ihnen unangenehm ist. Wenn Sie ein Nachlassen des Gehörs oder ein Klingeln in den Ohren feststellen, sollten Sie einen Ohrenarzt aufsuchen.
17. Setzen Sie den Apparat nicht Bratenfett oder dem Spritzen aus. Plazieren Sie die Nachrichten, die mit Flüssigkeiten (gefüllt werden Blumenvases, Getränkedosen, Kaffeetassen) nicht auf den Apparat.
18. WARNING: um die Gefahr des Feuers oder des elektrischen Schlages zu verringern, setzen Sie diesen Apparat nicht Regen oder Feuchtigkeit aus.

## Important Safety Instructions

### CE Declaration Of Conformity

See our website at:

<http://www.alesis.com>

### FCC Compliance Statement

This device complies with Part 15 of the FCC rules. Operation is subject to the following two conditions: (1) This device may not cause harmful interference and (2) this device must accept any interference received, including interference that may cause undesired operation.

NOTE: This equipment has been tested and found to comply with the limits for a Class B digital device, pursuant to Part 15 of the FCC Rules. These limits are designed to provide reasonable protection against harmful interference in a residential installation. This equipment generates, uses and can radiate radio frequency energy and, if not installed and used in accordance with the instructions, may cause harmful interference to radio communications. However, there is no guarantee that interference will not occur in a particular installation. If this equipment does cause harmful interference to radio or television reception, which can be determined by turning the equipment off and on, the user is encouraged to try to correct the interference by one or more of the following measures:

- Reorient or relocate the receiving antenna.
- Increase the separation between the equipment and receiver.
- Connect the equipment into an outlet on a circuit different from that to which the receiver is connected.
- Consult the dealer or an experienced radio/TV technician for help.

## Connecting AC Power

Before making any power connections, make sure the Ion's power switch is turned off.

1. Plug the female end of the power cable into the Ion's power socket.
2. Plug the male (plug) end into a properly grounded power outlet.



**WARNING:** Make sure the outlet is properly grounded. Plugging the Ion into an ungrounded outlet can be hazardous.

## Making Audio Connections

There are a couple ways to hook up your Ion synthesizer's audio outputs:

- **Stereo.** Connect two cables from the Ion's left and right outputs to two inputs of an amp or mixer.
- **Headphones.** Plug a set of headphones into the headphone jack on the rear panel.



**WARNING:** When connecting audio cables or turning power on and off, make sure that the amplifiers in your system are turned off or the volume controls are turned down. If you don't do this, you can create loud bursts of sound that might damage your speakers.

## Connecting the Foot Pedals

The Ion has two pedal jacks marked **(sust pedal)** and **(exp pedal)**. Plug a sustain pedal (not included) into the jack marked **(sust pedal)**.

**(sust pedal)** is designed to work with any standard momentary footswitch. It doesn't matter whether the footswitch is normally open or closed, as long as you plug it in before powering up your Ion; the instrument will calibrate itself.

**(exp pedal)** is designed to work with a Roland EV-5 pedal or equivalent.



**NOTE:** If your sustain pedal response is backward (i.e., notes sustain when your foot is off the pedal), turn off your Ion and make sure the footswitch plug is fully inserted into the **(sust pedal)** jack. Then, turn the Ion back on while keeping your foot off the footswitch.



### Connection Diagram

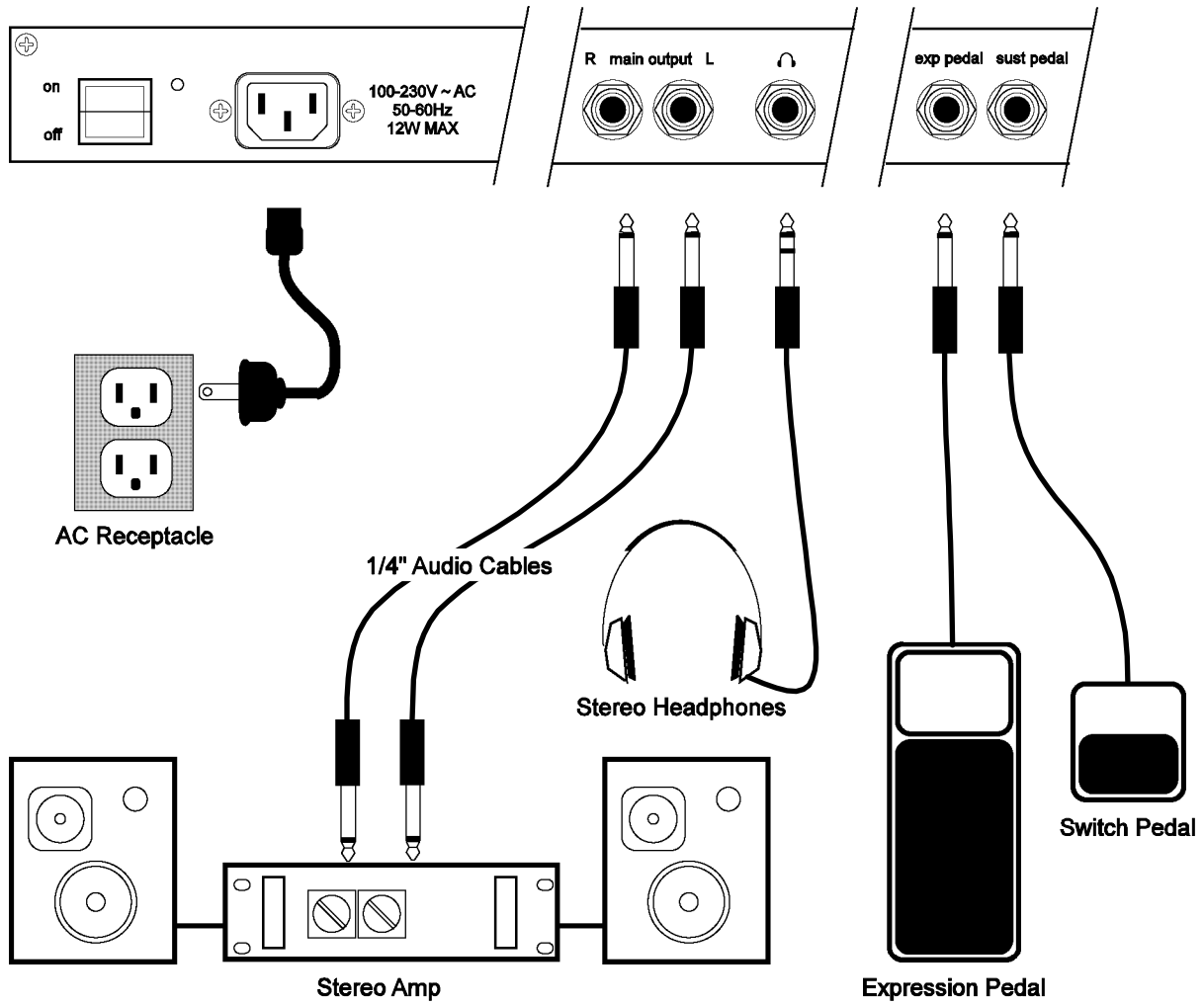



## A Tour of the Front Panel

### The display

The Liquid Crystal Display (LCD) is at the center of the Ion in more ways than one. Depending on the button or knob you've activated, it may show the program name, which Programs are used in a Setup, the values of the parameters being edited, or even a graphic representation of a waveform or an envelope.

There are four main screens that we'd like to describe in detail.

### The Home page

This is the screen that shows you the most different kinds of information all at once. If you're not already there, press the **[home]** button and you'll see something like this:

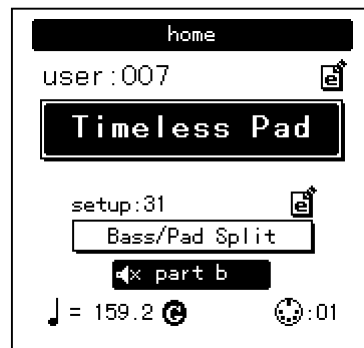

Here's what each area of the Home screen means:

- The darkened bar at the top of the screen shows you the name of the section being displayed. In this case, it reads **home**.
- Immediately below that are the **bank** and **program number**.
- Roughly in the middle you see the **program name** of the active Part.
- The fourth line from the bottom shows the **Setup number**.
- Below that, the outlined rectangle shows the current **Setup name**.
- The “e box” icons to the right of the Program and Setup numbers indicate that the Program and Setup have been edited, respectively.
- The filled rectangle on the second line from the bottom shows which of the four Parts has been selected with the **[panel active]** buttons. Note: the icon on the inside left of this box indicates that the current Part has been muted.
- The “quarter note” icon, the “equal to” sign (=) and the numbers to its right tell you what the tempo setting is for the Setup.
- The “G” to the right of the tempo value indicates the setting of the Global mode parameter **tempo source**. If the “G” is there, that means the tempo source parameter is set to **global**. This causes the tempo to remain the same when you recall a new Setup or change Programs. If the “G” is not there, the tempo source parameter is set to **program**. In this case, the tempo value can change from one Setup to the next, or when you call up another program in Part A.
- The “MIDI connector” icon and the number to its right indicate the MIDI Channel of the currently selected Part.

*A double-press of the **[home]** button also shuts off all eight of the Ion's voices and sends an All Notes Off command over MIDI.*

*The Global mode parameter **tempo source** is found on Global mode page 3, Soft button 2.*

### The Edit pages

Any time a knob is moved or a button is pressed, the Ion enters Edit mode and displays a screen with parameters related to that knob or button. The appearances of the pages can vary quite a bit, but there are some things they have in common:

- There can be up to three parameters displayed on any page. If the desired parameter does not have a front panel knob, select it using a Soft button and turn the **data** knob to edit the value.
- Sometimes there are several pages of parameters related to a given function. You will know this is the case by looking on the bottom line of the page, as in the example below:

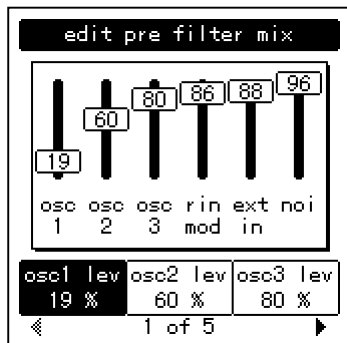

The numbers at the bottom of the page tell you how many pages there are, and which page you are on. In the above example, there are five pages available, and you are on page 1. When more than one page is available, you can navigate to the additional pages using the **[page ►]** and **[◀page]** buttons. Note that the arrow in the left corner is “grayed out.” That means that there are no more pages available in that direction.

### The Global pages

When the **[global]** button is pressed, the Ion will enter Global mode. There are multiple Global pages, and each contains parameters related to the way the Ion is configured. Select the desired parameter using a Soft button and turn the **data** knob to edit the value. These settings do not change from one Program or Setup to the next. For a complete description of the Global mode parameters, see Chapter 3.

### The Mod Matrix pages

When the **[mod matrix]** button is pressed, the Ion will enter Edit mode for the active Program and display parameters related to the Mod Matrix. This is also where the Tracking Generator is found. These are two of the most powerful features of the Ion, allowing flexibility and control over nearly every aspect of the sound. For a complete description of the Mod Matrix and the Tracking Generator, see Chapter 6.

*Remember: if there are two or more pages of parameters related to a given function, use the **[page ►]** and **[◀page]** buttons to access the other pages.*

## LED functions

The Ion's front panel has lots of LED lights. They serve many purposes:

- Two LEDs serve as “speed” indicators: the **rate** LED and the **tempo** LED. The **rate** LED may blink at a different speed depending on which of three functions has been selected in the LFO section: **[lfo 1]**, **[lfo 2]**, or **[s&h]**.
- The **mod** LEDs indicate that an edit has been made in the Mod Matrix that affects one or more of the parameters in the section where the **mod** LED is lit. If it isn't obvious at first which parameter is being “modded,” press the **[mod matrix]** button and look at the lists of sources and destinations. For more information on the Mod Matrix, see Chapter 6.
- The **loop** LED is similar to the **mod** LEDs in that it indicates that the loop parameter has been activated inside the selected envelope. More information about looping the envelopes can be found on pages 71-72.

## Button functions

**[edit]** buttons – A green LED indicates that an **[edit]** button has been pressed. This means that a particular set of parameters is being shown in the display for inspection and editing.

**Selection** buttons – Some buttons allow you to select between different sets of parameters that share a common knob or set of knobs. For example, the **[lfo 1]**, **[lfo 2]**, and **[s&h]** buttons determine which of those three functions will be controlled by the **rate** knob, and also call up parameters from that function in the display. Similarly, the **[pitch/mod]**, **[filter]**, and **[amp]** buttons determine which of those three envelopes will be controlled by the five knobs in the **env** section.

**Parameter** buttons – Other buttons edit or toggle the parameter under their control: for example, the **[mono/poly]** button or the **[octave]** buttons in the **osc** section. Other examples include the **[porta]** button, which enables portamento, and the **[waveform select]** buttons, which determine the waveform utilized by each oscillator.

## Special cases

**[tap tempo]** button – This button allows you to match the speed of the arpeggiator, an LFO, or other effects to the tempo of a song simply by tapping the button in time to the music! The LED under the button flashes to give you an idea of what the tempo setting is currently.

**[transpose]** and **[octave]** buttons – These three buttons control the global transposition and octave shift of the Ion's keyboard. The settings will affect all programs and setups, as well as the MIDI note output.

*NOTE: In order for an arpeggiator, LFO, or effect to respond to the **[tap tempo]** button, its sync parameter must be set to “tempo.”*

*A double-press of the **[transpose]** button resets the transposition amount to zero.*

## All Notes Off: the [home] button

In addition to taking you to the top level of a Program, the **[home]** button serves a dual function: a quick double-press of this button will shut off all eight of the Ion's voices and send an All Notes Off command over MIDI.

## Knob functions

With the exception of the **volume** knob, all of the knobs on the Ion are known as “360 pots,” as in “360 degrees of a circle.” This means they don't have a minimum or maximum physical position. When you grab one, it will edit the value of the parameter it controls from there. This prevents those annoying “jumps” between the value represented by the position of the pot and the value stored in software for the parameter. (Sometimes they can be very different.)

There are a few knobs that should be singled out for attention at this point:

- **volume** knob – This is the red knob just above the Pitch wheel. It controls the level of the **main** and headphone outputs. Note that this control has no effect on the **aux** outputs.
- **tempo** knob – This is the knob in the upper left corner of the Ion. It controls the speed of any number of functions, most notably the arpeggiator.
- **data** knob – This is the clear knob to the right of the display. Use it for fine-tuning your edits, or to edit a parameter that has no front-panel knob. It is also used for selecting Programs and Setups.

*Remember: In order for the S/H, an LFO, or effect to respond to the **tempo** knob, its sync parameter must be set to “tempo.”*

The functions of the rest of the knobs will be described in Chapter 5.

## Performance controls

The Ion gives you a number of expressive controls at your fingertips, in addition to all of the knobs and buttons:

- **Velocity** – The Ion's keyboard will respond to differences in how hard you play the keys. You can tailor-make the keyboard's response to your playing style by selecting one of the nine keyboard curves found on Global mode page 1, Soft button 2.
- **(p)** or Pitch Bend wheel – This wheel is normally assigned to bend the pitch of one or more oscillators, but it may be used as a source in the modulation matrix to control nearly any parameter.
- **(m1)** wheel – This wheel usually adds vibrato, but it also may be used as a source in the modulation matrix to control nearly any parameter.
- **(m2)** wheel – This wheel usually sweeps the filter, but it also may be used as a source in the modulation matrix to control nearly any parameter.

Even more control over the sound is available through the addition of an optional expression pedal, such as the Roland EV-5. And don't forget that you can grab any knob and tweak it during performance!

## What does “Global” mean?

A Global parameter is one that affects the entire Ion at once: every Program, every Setup, everything to do with MIDI or the arpeggiator, etc. Since they are universal, Global parameters are not stored with Programs or Setups.

A prime example of a Global setting is the **LCD Contrast** parameter on Global mode page 1, Soft button 1. Whatever value you choose for this parameter will affect the appearance of every single edit screen in the Ion, and affect them all equally.

## The Global parameters

To enter Global mode, press the **[global]** button.

### LCD Contrast

**Page:** 1  
**Soft Button:** 1  
**Range:** 1 to 180  
**Default:** 100

Depending on your viewing angle or lighting conditions, you may want to adjust this parameter. It controls the contrast between the text in the LCD and the LCD’s backlight.

*Remember: to reset any parameter to its default value, perform a quick double-press of its Soft button.*

### Keyboard Curve

**Page:** 1  
**Soft Button:** 2  
**Range:** 9 choices: linear (low/med/high)  
 logarithmic (low/med/high)  
 exponential (low/med/high)  
**Default:** exponential medium

These settings allow you to configure the Ion to match your playing style. Experiment with the different choices to see which curve suits you best.

### LCD Mode

**Page:** 1  
**Soft Button:** 3  
**Range:** edit only, lcd jump  
**Default:** lcd jump

This parameter determines how the Ion will respond when you turn a knob. A setting of **edit only** means the Ion will not update the display when you turn a knob. You may prefer this when performing live, for example, because you won’t have to press the **[home]** button in order to know which program is active. A setting of **lcd jump** means the Ion will respond immediately when you turn a knob and put that parameter’s page on the display, with that parameter highlighted. You may find that this setting works better for studio environments.



## Master Tune

**Page:** 2  
**Soft Button:** 1  
**Range:** 391.99 to 493.88 Hz  
**Default:** 440.00 Hz

This parameter allows you to tune the Ion flat or sharp within a significant range, to facilitate working with instruments that are not at concert pitch.

## Transpose

**Page:** 2  
**Soft Button:** 2  
**Range:** -12 to +12 in chromatic steps  
**Default:** 0

This parameter allows you to transpose the Ion's keyboard up or down in half-step increments over a total range of two octaves. There is an even faster way to transpose the Ion: hold the **[transpose]** button and press a key above or below the middle C on the keyboard, and the Ion will be transposed by that amount. To transpose back to concert pitch, hold **[transpose]** again and press the middle C. Another way to reset the transposition amount to zero is to press the **[transpose]** button twice quickly.

*A double-press of the **[transpose]** button resets the transposition amount to zero.*

*NOTE: The settings of the Transpose and Octave parameters will also change the MIDI note output of the Ion by the same amount.*

## Octave

**Page:** 2  
**Soft Button:** 3  
**Range:** -3 to +3  
**Default:** 0

With this parameter you can transpose the Ion up or down in octave increments over a range of 7 octaves, for a total range of 10 octaves (including the range covered by the keyboard). This parameter also has a pair of dedicated front panel buttons that will edit the value and take you to this page.

## MIDI Sync

**Page:** 3  
**Soft Button:** 1  
**Range:** ext sync, gen midi clock, off  
**Default:** off

The Ion gives you the option to synchronize the arpeggiator, et al, to an incoming MIDI clock. If a value of **ext sync** is selected, any function of the Ion that has its sync parameter set to **tempo** will slave to the external MIDI clock. If a value of **gen midi clock** or **off** is selected, the Ion will ignore incoming MIDI clock messages. A setting of **gen midi clock** tells the Ion to send out MIDI clock messages so external MIDI devices, such as drum machines, can slave to the Ion's arpeggiator.

## Tempo Source

**Page:** 3  
**Soft Button:** 2  
**Range:** program, global  
**Default:** program

You may have noticed a reverse-colored “G” at the bottom of the Home page. This icon appears when the tempo source parameter is set to **global**. When it is, the tempo value will remain the same when you recall a new Setup or change the program in Part A. When the tempo source parameter is set to **program**, the “G” on the Home page goes away. In this case, the tempo value can change from one Setup to the next, or when you call up another program in Part A.

## MIDI Bank Select

**Page:** 3  
**Soft Button:** 3  
**Range:** cc 0, cc 32  
**Default:** cc 0

This parameter allows you to designate which MIDI controller number the Ion will recognize and transmit as a Bank Select message.

## Mod Wheel 2 CC

**Page:** 4  
**Soft Button:** 1  
**Range:** channel pressure, cc 2-4, 7-31, 64-95, 102-119  
**Default:** channel pressure

This parameter allows you to determine which MIDI controller or controller number the Ion will transmit when you use (**m2**). It will also consider incoming MIDI messages that match this setting to have been generated by that wheel.

## Exp Pedal CC

**Page:** 4  
**Soft Button:** 2  
**Range:** channel pressure, cc 2-4, 7, cc 7+vol, cc 8-31, 64-95, 102-119  
**Default:** cc 7+vol

This parameter allows you to determine which MIDI controller or controller number the Ion will transmit when you use the expression pedal. It will also consider incoming MIDI messages that match this setting to have been generated by the pedal.

The default setting of **cc 7+vol** allows you to control the overall volume of the Ion and send MIDI volume commands at the same time.

*NOTE: The **exp pedal** and (**m2**) are limited to the use of certain MIDI controller (CC) numbers. The CC numbers that are not available are reserved for front panel knobs and buttons. This allows your live edits to be performed into a sequencer!*

*Remember: to reset a Global parameter to its default value, perform a quick double-press of its Soft button.*



## Exp Pedal Curve

Page:	4
Soft Button:	3
Range:	linear, exponential
Default:	linear

This parameter governs the response of the expression pedal. Try the different options with your pedal to see which seems to work best.

## Arp Send MIDI

Page:	5
Soft Button:	1
Range:	on, off
Default:	off

You have the choice to enable the arpeggiator to send the notes it generates to an external device. A setting of **on** will allow your sequencer to capture your performance exactly as it happened. It will also enable the Ion to arpeggiate other synthesizers! If this parameter is set to **off**, the arpeggiator will still control the Ion internally, but the Ion will only send out the notes that you hold down.

## Arp Retrigger

Page:	5
Soft Button:	2
Range:	key poly, key mono, mono
Default:	key poly

This parameter determines the way the arpeggiator will respond from Part to Part within the Setup:

- **key poly** – each Part’s arpeggiator functions independently. The Part’s arpeggiator “clock” is reset when a note is played in that Part and no other notes in the Part are being held down. This ensures that the first note of an arpeggiation in a Part will sound immediately when the key is hit.
- **key mono** – there is effectively a single arpeggiator clock for all four Parts. The clock is reset when a note is played and no other notes in any Part are being held down. This ensures that the arpeggiators of all four Parts will be synchronized.
- **mono** – there is a single arpeggiator clock for all four Parts. This clock is only reset when the “tap-tempo” button is pressed. This allows the user to lock to an external beat using the “tap-tempo” feature and have all arpeggiation thereafter synched to that beat.



## Analog Drift

**Page:** 5  
**Soft Button:** 3  
**Range:** on, off  
**Default:** on

An analog synthesizer is a comparatively unstable device. Its components tend to be imprecise, never producing a truly constant value. Synthesizer enthusiasts call this tendency “drift,” and it is often cited as a major part of the difference between the “warm” sound of analog synths and the “cold” sound of digital synths.

The Ion can model the “drifting” behavior of analog synths as well. An Analog Drift setting of **on** will cause the frequencies for each of the oscillators and filters per voice to “drift” according to a special algorithm we developed. To make the Ion sound even more realistic, they each drift independently. Try it; it’s a subtle but very pleasing and effective feature.

## Last Part Enable

**Page:** 6  
**Soft Button:** 1  
**Range:** on, off  
**Default:** on

This parameter helps you configure how the Ion handles live edits of a Setup. When set to **on**, it is not possible to disable the last active Part. This helps you avoid accidentally turning off all of the Parts and getting no sound. When set to **off**, any Part can be enabled or disabled from the top panel, even if it is the only Part enabled. That way you can turn off one Part before enabling another, as opposed to having to enable the second Part before you can turn off the first Part.

## P/M Wheel LEDs

**Page:** 6  
**Soft Button:** 2  
**Range:** level track, always on  
**Default:** always on

The translucent **(p)** and **(m)** wheels have lights that illuminate them from below. This parameter gives you the option of having those lights shine at a static level (**always on**) or become brighter and darker as the wheels are moved forward and backward (**level track**).

## Pgm Write Protect

**Page:** 6  
**Soft Button:** 3  
**Range:** on, off  
**Default:** on

When set to **on**, only the User Bank may be used to store Programs. When set to **off**, Programs may be stored to any of the four Banks (Red, Green, Blue or User). For more information, see the description of Store mode on page 26.

*Remember, Programs may be stored one at a time, or an entire Bank may be moved from one Bank to another or sent over MIDI. This enables you to store your User bank in a safer place, for example, while still having it available on the keyboard when it’s time to perform. The Program Write Protect Global parameter makes this all possible.*

This page intentionally left blank.

## What is a Setup?

A **Setup** is an arrangement of up to four Parts, which are Programs that have been split or layered across the keyboard. The combined settings of all four “zones” of the keyboard are what make up a Setup.

## Programs vs. Parts

Parts reside at a slightly higher level of the Ion’s hierarchy than do Programs. A Part consists of the Program plus settings for key range, MIDI channel and controllers, panning, transposition, etc. You can select a new Program within the Part without affecting these other settings.

### Selecting Parts

To switch from one Part to another, use the four **[panel active]** buttons. If you want to know which Programs are being used in a Setup, for example, press the **[home]** button and then switch between the Parts using these buttons. You don’t have to be at the Home page in order to do this, though; you can switch between Parts no matter what page you are editing. In addition to seeing the values of that page change as you switch between the Parts, you will probably see the front panel LEDs change to reflect their status in the different Programs.

*A double-press of the **[home]** button also shuts off all eight of the Ion’s voices and sends an All Notes Off command over MIDI.*

### Selecting Programs

To select a new Program within the Part, use the **[bank]** and **[select]** buttons, or simply press the **[home]** button and turn the **data** knob. Note that calling up a new Program doesn’t change the split point, for example, or the transposition amount.

## How the Effects are Shared

Each of the four Parts in a Setup has its own Drive effect (compressor, fuzz, etc.). However, they share a common stereo Effect (phaser, flanger, vocoder, etc.). So even though the settings for both the Drive effect and the stereo Effect are stored with each Program, it is the Program in Part A that determines which stereo Effect the four Parts will share. This is why you may hear the overall sound change more drastically when changing the Program in Part A than you do when you change the Program in one of the other Parts.

## Storing a Program or Setup

### Storing a Program

Once you have made an edit to a Program that you would like to keep, press the **[store]** button to enter Store mode. You will see a screen that looks like this:



### Storing a Setup

If you have made changes to a Setup and are ready to save it, press the **[store setup]** button to enter Store Setup mode. The screen you see will be nearly identical to that pictured above.

### Choosing the destination for the new Program or Setup

Once you are in Store mode, if you don't want to keep the Program you started with, you can simply press the same **[store]** button a second time to store the edited Program back to its original location. However, if you want to save the original Program you will need to choose a different location.

Soft button 1 calls up the screen in which you choose a new location for the edited Program. Use the **[select]** buttons and/or the **data** knob to choose the destination number. Once you are sure that you will not be overwriting a Program you would prefer to keep, press the same **[store]** button a second time. The Ion will store your edited Program to the location you have selected.

*The procedures for storing Programs and Setups are nearly identical. Wherever they differ we will point that out. However, as we document the features and methods, the term "Program" will stand for both Programs and Setups unless otherwise specified.*

*There are two pages in Program Store mode. Page 1 deals with storing the Program internally; Page 2 deals with storing it externally, or sending it over MIDI in system exclusive (sys-ex) format. We will address sys-ex functionality on pages 29-32 and in chapter 8 "MIDI."*

**Program Store mode only:** You can use the **[bank]** buttons to select a destination location as well, but you will not be able to store the program to any bank besides the **[user]** bank unless you turn off the Program Write Protect parameter in Global Edit mode, Page 6, Soft button 3.

**Note:** The **[select]** buttons cannot be used for choosing a destination location when storing a Setup.

## Naming a Program or Setup

You may want to give the Program a new name to distinguish it from the original Program. There are several ways to create a new name or alter an existing one, using a combination of Soft buttons 1 and 2, the **data** knob, and the keyboard.

First, press either Soft button 2 or 3. The Store page will change to look like this:

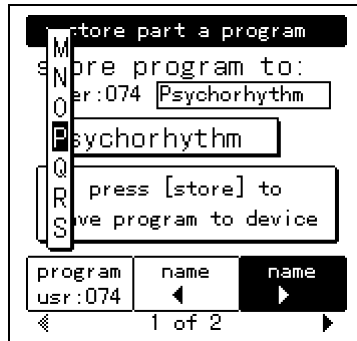

### Using the Soft buttons and the data knob

The vertical column shows you the alphanumeric choices that are immediately available by turning the **data** knob. Soft buttons 2 and 3 move this column to the left or the right, respectively. Choose the letter in the name you would like to change and move the column to that spot.

### Using the keyboard

With so many characters available for creating a name, it could be quite cumbersome without a shortcut to the characters you're most likely to use. The Ion keyboard can be used to call up letters, numbers, and even a couple of punctuation marks. Once you know your way around, this is a real time-saver. Here's how they are laid out:

- The lowest C on the keyboard enters a space.
- Starting with the D above that, the white keys are used to enter the letters of the alphabet. For example, the lowest D key enters the letter "A." The top A key on the keyboard enters "Z." And if you hit one of these keys repeatedly, the letter will switch from uppercase to lowercase.
- The top B and C keys enter an exclamation point (!) and a question mark (?) respectively.
- The black keys in the *second* and *third* octaves from the left are used to enter the numbers 0-9. **Be careful!** The black keys in the lowest octave do something quite different, which is detailed on the next page.

*The exact same process is used for naming Programs and Setups. As we document the features and methods, we will use the term "Program" to stand for both Programs and Setups.*

### Inserting and deleting characters using the keyboard

The two lowest black keys perform a special function.

- The Db key will insert a space, taking all letters to the right of and including the vertical column and pushing them to the right. Once a letter exceeds the right-most side, it is erased.
- The Eb key will delete a space, taking all letters to the right of and including the vertical column and pulling them to the left. Once a letter enters the vertical column, it is erased.

### The complete cast of characters

The following chart includes all of the characters that are available when creating a name.

### Character chart

A	B	C	D	E	F	G	H	I	J	K	L	M	N	O	P	Q	R	S	T	U	V	W	X	Y	Z
!	?	.	,	+	-	=	@	\$	#	%	"	`	'	\	/	(	)	<	>	{	}	[	]	_	*
	~	^	:	;	&	0	1	2	3	4	5	6	7	8	9										
a	b	c	d	e	f	g	h	i	j	k	l	m	n	o	p	q	r	s	t	u	v	w	x	y	z

## Sending a Program or Bank via Sys-Ex

The second page of Store mode contains features related to storing a Program or bank of Programs on an external device via MIDI, such as a computer with a librarian program, a MIDI data filer, or even another Ion.

### Sending a single Program

The first thing to do is press the **[store]** button above the **data** knob, if you're not already in Store mode. Next, use the **[page ►]** button to navigate to page 2. You'll see a page that looks like this:



The “from” location over Soft button 1 should be the same as the number of the Program you were editing. **The “to” location must be selected carefully.** When you press the **[store]** button the second time, a little marker is placed in the Program data that tells the Ion to put the Program **in the “to” location** when it is sent back via MIDI. This is fine if you're expecting it, but if you aren't it can be difficult to find the Program that was sent over. You may not remember what the original location of the Program was when you sent it out. There's a solution to this dilemma, but we'll write about that in the section called “Special Cases” on the next page. We have other things we need to cover first.

Be sure the Program number in the “from” category is the one you want to send out. If it isn't, use the **data** knob or **[select]** buttons to select the proper Program. Then use Soft button 2 to select the “destination” to which your MIDI device will send the Program when it is retransmitted.

Once you have selected the source (“from”) and the destination (“to”), press the **[store]** button a second time. The sys-ex data for that Program will be sent out the Ion's MIDI jack.

### Sending an entire Bank

The process for sending an entire Bank over MIDI is much the same as sending out a single Program. From page 2 of Store mode, use the **[select]** buttons or **data** knob to change the “from” value until it reaches Program 127 in the current Bank. Then turn the **data** knob one more value clockwise to the “all” option. Use the **[bank]** buttons to select the

*The processes for transmitting Programs and Setups over MIDI are slightly different. We will cover the process for Programs in this section. The process for transmitting Setups is documented on page 31.*

*Programs and Banks may be moved from one Bank to another when sent over MIDI. In order for a User Program or Bank to be received by the Blue bank, for example, the “from” and “to” Bank locations must be set properly. Then when the Program or Bank is sent back to the Ion, the Global “Program Write Protect” parameter must be set to “off.”*

*Tip: use the [bank] buttons as a shortcut to get from a low Program number to a high one, whatever mode you're in. For example, if you have User Program 0 selected on the Home page and you want to reach User Program 127 quickly, turn the data knob one click counter-clockwise, which will take you to Blue Program 127. Then press the [user] bank button and you're there!*

bank you wish to transmit (“from”) and the bank you wish it to come back as (“to”). Press **[store]** a second time and the Bank will be sent out the Ion’s MIDI jack.

## Special cases

### Store Program mode

There are a few options between the “User:all” and the “Red:000” choices of the “Send Program to MIDI” page that should be pointed out. They are called **edit:a**, **edit:b**, **edit:c**, and **edit:d**. These stand for the four Program edit buffers in the current Setup.



Of course, these are useful as a “from” location, but they are even more useful as a “to” location. Herein lies the solution to the problem of knowing where a Program will arrive when it is sent back to the Ion via MIDI, and wondering if it will accidentally overwrite something you wanted to keep. The solution: **always select one of the edit buffers as the “to” location**. When the Program comes back, you won’t have to go fishing for it in the middle of a Bank of 127 Programs; it’ll be in one of four non-destructive locations. If you want to narrow it down even further, always select the same edit buffer, be it edit:a or edit:d, as the destination. If you’re consistent with this, you’ll save yourself a lot of headaches later on.

### Store Setup Mode

The “Send Setup to MIDI” page, discussed immediately below, has an extra option called “edit” that is equivalent to the edit:a-d options on the “Send Program to MIDI” page. If you want to keep your options open when transmitting a single Setup to MIDI, select the “edit” option as the “to” location. That way it will always be returned to the Setup edit buffer, where you can place it in a location known at that time to be available.



## Sending One Setup or All Setups via Sys-Ex

The second page of Store mode contains features related to storing one Setup or all 32 Setups on an external device via MIDI, such as a computer with a librarian program, a MIDI data file, or even another Ion.

*Be sure to read the previous section, “Special Cases,” for an explanation of the “edit” option found on the “Send Setup to MIDI” page.*

### Sending a single Setup

The first thing to do is press the **[store setup]** button to the right of the **[part enable]** buttons, if you’re not already in Store Setup mode. Next, use the **[page ►]** button to navigate to page 2. You’ll see a page that looks like this:



The “from” location over Soft button 1 should be the same as the number of the Setup you were editing. **The “to” location must be selected carefully.** When you press the **[store setup]** button the second time, a little marker is placed in the Setup data that tells the Ion to put the Setup **in the “to” location** when it is sent back via MIDI. This is fine if you’re expecting it, but if you aren’t it can be difficult to find the Setup that was sent over. You may not remember what the original location of the Setup was when you sent it out. There’s a solution to this dilemma, and that information is covered in the section called “Special Cases” on the previous page.

Be sure the Setup number in the “from” category is the one you want to send out. If it isn’t, use the **data** knob to select the proper Setup. Then use Soft button 2 to select the “destination” to which your MIDI device will send the Setup when it is retransmitted.

Once you have selected the source (“from”) and the destination (“to”), press the **[store setup]** button a second time. The sys-ex data for that Setup will be sent out the Ion’s MIDI jack.

### Sending all Setups

The process for sending all of the Setups over MIDI is much the same as sending out a single Setup. From page 2 of Store mode, use the **data** knob to change the “from” value until it reaches Setup 31. Then turn the **data** knob one more value clockwise to the “all” option. Press **[store]** a second time and the Bank will be sent out the Ion’s MIDI jack.

## Sending All Programs and Setups via Sys-Ex

There is a method for backing up all 512 Programs, all 32 Setups, and your Global settings at one time. You can access this option from either Store Program mode or Store Setup mode. In either case, it is on page 2, Soft button 3. To initiate the bulk dump, navigate to this screen and press the same **[store]** button a second time. All data will be sent out the Ion's MIDI jack.

## Storing and Recalling Setups

There are 32 Setup locations available in the Ion, all of which may be overwritten with your own Setups. The procedure for storing a Setup is essentially identical to that for storing a Program. For information on this process, see the section "Storing a Program or Setup" on page 26.

### Recalling a Setup

When the Ion is first turned on, it will automatically recall the last Setup you were on when you turned the unit off. If you want to call up a different Setup, press the **[recall setup]** button. You will see a screen that looks like this:

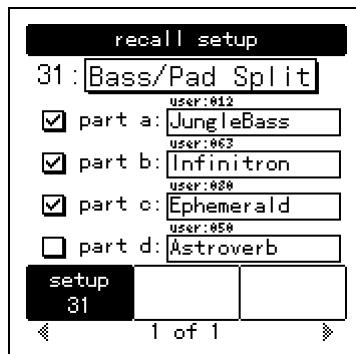

As you can see from the illustration above, the Recall Setup screen shows you all four Parts within the current Setup and the names and locations of the Programs they use. The boxes on the left indicate whether or not each of the four Parts is active in the current Setup. If a box is checked, its Part is active.

Use the **data** knob to recall one of the 32 Setups. As soon as you turn the knob, the new Setup will become the current Setup. As evidence of the change, you will see the **[part enable]** buttons turn on or off depending on whether the Parts they represent are active in the current Setup.

**Caution!** As soon as you turn the **data** knob you will lose the current Setup. Be sure you have saved any edits you would like to keep before selecting a new Setup.

## Compare Mode

When you select a new Program or recall a Setup, it is placed in a temporary workspace known as an “edit buffer.” There is an edit buffer for each Program within the current Setup and for the Setup itself. This allows you to edit the Program or Setup without affecting the original stored version of the item. If at any time you want to compare the edits you have made to the original Program or Setup, press the **[compare]** button.

When you press the **[compare]** button its LED will light, and all four Programs and the Setup will switch to their original stored versions. To return to the edited versions, press the **[compare]** button again. Its LED will turn off and your edits will be restored.

*While in Compare mode, you will be unable to make any edits to the Programs or the Setup (except to enable or disable the Parts). If an edit is attempted, the **[compare]** LED will flash to remind you that you are in Compare mode.*

## Part Parameter Descriptions

In this section of the manual we will go through the Part parameters one at a time, defining each parameter and describing how each affects the Setup. The parameters are listed by the Edit Part page name, the page number, and the Soft button used to access them. Also listed is the default value for each parameter.

### Program Bank

**Page:** 1  
**Soft Button:** 1  
**Range:** red, green, blue, user  
**Default:** user

This parameter simply shows you the status of the **[bank]** buttons to the right of the **data** knob. You could just look, of course, but the existence of this parameter drives home the point that a given Program is actually a component of a Part, which in turn is part of a Setup. This parameter ensures that the next time you recall the Setup, the proper Program from the proper Bank will be recalled into this Part as well.

### Program

**Page:** 1  
**Soft Button:** 2  
**Range:** 000-127  
**Default:** 000

As with the Program Bank parameter, the Program parameter ensures that the next time you recall the Setup, the Program number will be remembered and recalled into this Part. Remember that the Program is actually a component of a Part, which in turn is part of a Setup.

This page also shows you six Programs at a time, which is handy when you're searching for a particular Program.

## MIDI Channel

**Page:** 1  
**Soft Button:** 3  
**Range:** 1-16  
**Default:** 1

This parameter defines the MIDI Channel for the selected Part. This is the channel on which all data for this Part will be transmitted and received.

## MIDI/Local

**Page:** 2  
**Soft Button:** 1  
**Range:** midi only, local only, midi+local  
**Default:** midi+local

This parameter determines the keyboard and MIDI transmit and receive status for the selected Part:

- **midi only** – equivalent to “local off.” The selected Part’s Program will not be heard when the keys are played. However, the Ion will send and receive MIDI data to and from an external device.
- **local only** – the selected Part’s Program may be played from the keyboard, but the Ion will not transmit or respond to external MIDI data.
- **midi+local** – the selected Part’s Program may be played from the keyboard, and the Ion will transmit MIDI data to an external device for this Part.

*NOTE: in all three cases, the selected Part will still respond to incoming MIDI data.*

## Low Key

**Page:** 2  
**Soft Button:** 2  
**Range:** 0-127  
**Default:** 0

To limit the number of keys the selected Part occupies, use this parameter and the next one, High Key. You may use the **data** knob to set or adjust the lower limit of the Part’s range, but a faster way is to hold Soft button 2 and press the desired key. The Low Key value will update to reflect the MIDI number of the key you pressed.

*Remember: to reset a parameter to its default value, perform a quick double-press of its Soft button.*

## High Key

**Page:** 2  
**Soft Button:** 3  
**Range:** 0-127  
**Default:** 127

To limit the number of keys the selected Part occupies, use this parameter and the previous one, Low Key. You may use the **data** knob to set or adjust the upper limit of the Part’s range, but a faster way is to hold Soft button 3 and press the desired key. The High Key value will update to reflect the MIDI number of the key you pressed.

*Tip: If the Low Key is set higher than the High Key, the Ion will create a “hole” in the middle of the Part where no voices will play.*

## Out Level

**Page:** 3  
**Soft Button:** 1  
**Range:** 0-100%  
**Default:** 100%

The Out Level parameter sets the level of the Part within the Setup. It is distinct from the Program Output Level parameter controlled by the knob on the right side. This parameter allows you a further level of mix control so you can balance the levels of the Parts without editing the level stored with the Program. Remember, it's possible that Program might be used in another Setup, so it's better to make this adjustment inside the Part.

## Out Balance

**Page:** 3  
**Soft Button:** 2  
**Range:** center, 1-100% main, 1-100% aux  
**Default:** center

The Out Balance parameter determines whether the selected Part will be sent to the **main output**, the **aux output**, or a definable mix of both. This gives you the capability of isolating a Part in one set of stereo outputs, or even sending each Part in the Setup to a separate, mono output (when used in conjunction with the Pan parameter described on the next page).

## EFX Level

**Page:** 3  
**Soft Button:** 3  
**Range:** 0-100%  
**Default:** 100%

The EFX Level parameter sets the Effects level of the Part within the Setup. This is not to be confused with the Program Effects Level parameter controlled by the knob on the right side. Remember, the Program in Part A selects the shared Effect for all four Parts. You may want to adjust the amount of Parts B through D being sent to that Effect; that is what this parameter allows you to do.

*The EFX Level parameter serves as a Send Level control to the shared Effect. It does not override the level of the Drive effect, as each Program retains its own Drive effect in a Setup. You can edit this level using the Drive knob. Once you have the Drive effect level set the way you like it, be sure to store the Program so your changes are remembered! Otherwise these settings will be lost when you recall a new Setup.*

## Pan

**Page:** 4  
**Soft Button:** 1  
**Range:** center, 1-100% L, 1-100% R  
**Default:** center

The Pan parameter determines the position of the selected Part in the stereo field. When used in conjunction with the Out Balance parameter described on the previous page, it is possible to send each Part in the Setup to a separate, mono output.



## Sust Pedal Enable

**Page:** 4  
**Soft Button:** 2  
**Range:** on, off  
**Default:** on

When this parameter is set to **on**, the currently selected Part will respond to the **sust pedal** and will send and receive sustain pedal commands via MIDI. When set to **off**, the selected Part will neither send nor respond to sustain pedal commands.

## Exp Pedal Enable

**Page:** 4  
**Soft Button:** 3  
**Range:** on, off  
**Default:** on

When this parameter is set to **on**, the currently selected Part will respond to the **exp pedal** and will send and receive exp pedal controller messages via MIDI. When set to **off**, the selected Part will neither send nor respond to exp pedal messages.

*The MIDI continuous controller numbers for (m2) and the exp pedal are selected in the Global parameter section. To select a different value, go to Global Edit page 4, Soft buttons 1 and 2, respectively.*

## Pitch Wheel Enable

**Page:** 5  
**Soft Button:** 1  
**Range:** on, off  
**Default:** on

When this parameter is set to **on**, the currently selected Part will respond to the (**p**) wheel and will send and receive pitch bend messages via MIDI. When set to **off**, the selected Part will neither send nor respond to pitch bend messages.

## Mod 1 Wheel Enable

**Page:** 5  
**Soft Button:** 2  
**Range:** on, off  
**Default:** on

When this parameter is set to **on**, the currently selected Part will respond to the (**m1**) wheel and will send and receive controller 1 messages via MIDI. When set to **off**, the selected Part will neither send nor respond to controller 1 messages.

## Mod 2 Wheel Enable

**Page:** 5  
**Soft Button:** 3  
**Range:** on, off  
**Default:** on

When this parameter is set to **on**, the currently selected Part will respond to the **(m2)** wheel and will send and receive its assigned controller number information via MIDI. When set to **off**, the selected Part will neither send nor respond to MIDI messages at its assigned controller number.

## Transpose

**Page:** 6  
**Soft Button:** 1  
**Range:** -12 to +12 in chromatic steps  
**Default:** 0

This parameter allows you to transpose the selected Part up or down in half-step increments over a total range of two octaves, independently of the other Parts. In this way you can transpose one Part chromatically without affecting the other Parts in the Setup.

## Octave

**Page:** 6  
**Soft Button:** 2  
**Range:** -3 to +3  
**Default:** 0

With this parameter you can transpose the selected Part up or down in octave increments over a range of 7 octaves, for a total range of 10 octaves (including the range covered by the keyboard). This allows you, for example, to drop a bass by a couple of octaves and raise a brass sound by an octave without affecting the other Parts in the Setup.

*The MIDI continuous controller numbers for **(m2)** and the **exp pedal** are selected in the Global parameter section. To select a different value, go to Global Edit page 4, Soft buttons 1 and 2, respectively.*

*NOTE: The settings of the Part Transpose and Part Octave parameters will not change the MIDI note output of the selected Part.*

This page intentionally left blank.



## How the Ion Makes Sound

The Ion generates sound by emulating, or “modeling,” the behavior of an analog synthesizer. Generally, it is helpful to think in terms of the signal moving from the left side of the top panel to the right side. The oscillators are fed into the filters, which in turn are fed into the amplifiers.

As the signal moves through that basic path, you are able to adjust the mix of the signal at several points, apply various modulations and envelopes, and add effects. In this way, the Ion can generate a virtually limitless variety of sounds.

Let’s take a quick look at the Ion’s signal path, from start to finish.

## The Oscillators

The oscillators are where sound is born. You may have heard that what you perceive as “sound” is simply vibrating air molecules hitting your eardrums. That vibration has to start somewhere, and in the Ion, it comes from the oscillators. By varying the *frequency* of the vibration, the oscillators can produce different pitches, which are heard as musical notes. By adjusting the *waveform type* and *shape*, the oscillators can produce various harmonics, which are heard as different timbres. Each of the Ion’s voices contains three oscillators.

## The Pre Filter Mix

The outputs of the oscillators, as well as a few other signal sources, are fed into a virtual mixing board called the Pre Filter Mix. The job of this mixer is to funnel all of these sources into the inputs of the next sound processing stage—the filters. For each source, you can specify its *level*, which is how loud it should be, and its *balance*, which determines how much of it goes to Filter 1 and how much to Filter 2.

## The Filters

The sound produced by the oscillators is very raw, and usually not suitable to be used directly in an instrument. In order to bring out the sonic textures you have in mind, you will typically want to dampen certain harmonics and boost others. This is where the filters come in. Filters alter the frequency content of the signal, and can have a drastic effect on the sound. A filter typically allows you to adjust its *cutoff frequency*, which represents the range of harmonics that the filter operates on, as well as its *resonance*, which determines how much boost is given to harmonics around the cutoff frequency. Each of the Ion’s voices contains two filters, and each filter can be one of eighteen different types, each with its own character and sonic flavor.

## The Post Filter Mix

The outputs of the filters need their own virtual mixing board as well, and that's what the Post Filter Mix is for. For each filter output, as well as a pre filter signal of your choice, you can specify a *level*, which is how loud it should be, and a *pan*, which determines how much goes to your left speaker and how much to the right.

## Output

The sound is getting near the end of its journey, but still has one more processing stage to go through. In the output stage, the Ion allows you to apply a *drive effect*, to give the sound a final push and add some compression, distortion, or other amplification effect. You also get to choose the overall level for the sound, as well as how much of it gets sent to the Ion's dedicated effects processor.

## Signal Flow Diagram

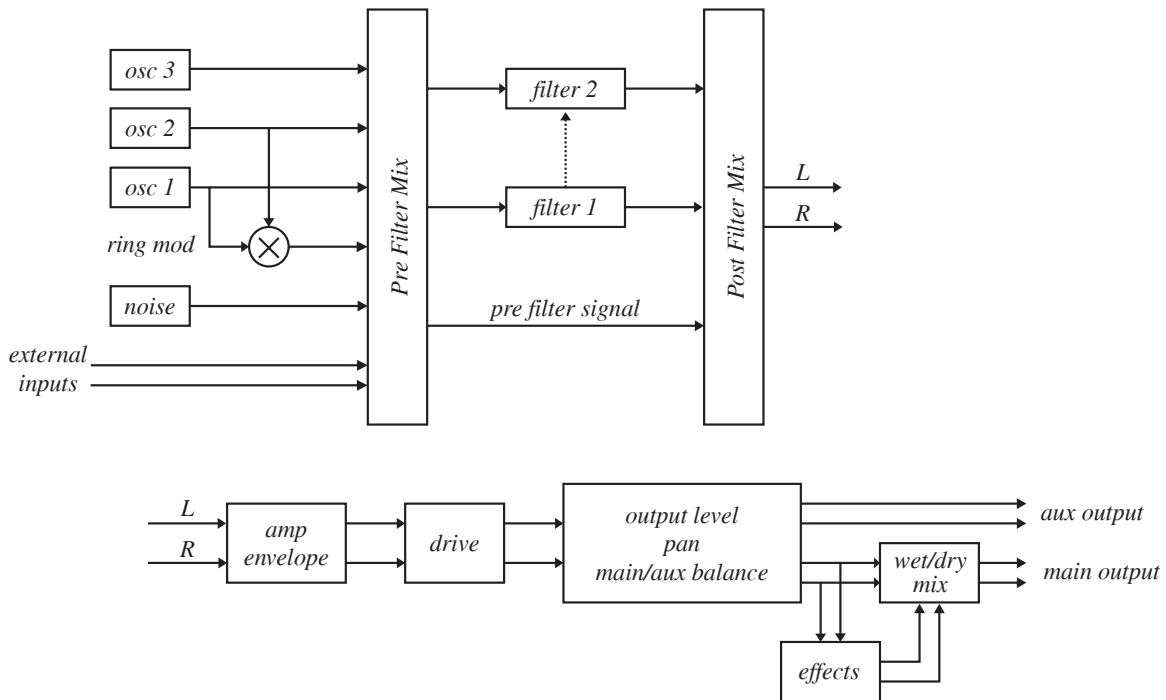

## Modulation

At this point, you may think that producing a sound with the Ion is simply a matter of configuring the parameters for the oscillators, filters, and mixers, and then hitting a key. And although it's true that you can design some nice instruments this way, generating the really awesome sounds invariably involves tweaking some of those parameters while a note is playing. The problem with that, if you're anything like us, is that you only have two hands, and you are probably using at least one of them to hit the notes in the first place. Fortunately, the Ion is willing to lend you a helping hand—twelve of them, in fact.

The Ion allows you to set up twelve *modulation routes*. Each of these is a virtual connection between some physical or internally-generated source and some program parameter. Basically, a mod route tells the synth to automatically grab a knob and tweak it while a note is playing. Although there are quite a few sources that you can use for your mods, the most common ones involve the LFOs and the envelopes.

### The LFOs

LFO stands for “low frequency oscillator”. Unlike the normal oscillators, however, the LFOs are not designed for producing sound. Instead, their purpose is to tweak a program parameter according to a looping pattern. For example, if you are looking to add some vibrato to your instrument, you'll need the pitch to continuously waver up and down. An LFO is perfect for this application. Simply hooking up an LFO to the oscillator pitch parameter will get you the effect you need. Each of the Ion's voices contains two LFOs.

### The Envelopes

If you hit a note on a piano, you'll hear a burst of sound energy as the hammer strikes the string, followed by lower level of loudness as you hold down the note and let the string ring out, which fades quickly as soon as you release the note and the damper is applied. Synthesizer designers model this behavior using *ADSR envelopes*. ADSR stands for “attack, decay, sustain, release”, and represents the different stages that the sound goes through over the life of the note. Since the most important application of the envelope is to control the loudness of the sound, the Ion provides one envelope that is specifically designed for this purpose. This is the *amp envelope*. However, envelopes are useful in all sorts of mod routes, which is why you can hook up any of the Ion's envelopes to any modulatable program parameter. Each of the Ion's voices contains three envelopes.

## Program Parameter Descriptions

In this section of the manual, we will go through the Ion section by section, defining each parameter and describing how each relates to the others. As with the signal flow, we will be moving from left to right across the front panel of the Ion. The parameters are listed by the Edit page name, the page number, and the Soft button used to access them. Also listed is the default value for each parameter.

### Voice: the [unison] button

This button toggles Unison mode on and off. It also immediately takes you to Voice Edit page 1 with the Unison Voices parameter selected, so you can determine how many voices you want assigned to one key when you enable Unison mode. For a description of the three Unison mode types and related parameters, see Unison voices and Unison detune in the next two paragraphs.

#### Voice [edit]: Unison voices

**Page:** 1  
**Soft Button:** 1  
**Range:** 2 voices, 4 voices, full  
**Default:** full

The setting of this parameter controls the response of the [unison] button. It determines how many voices will be allocated per key when Unison mode is on. When set to **2 voices** each key will trigger 2 voices, allowing a maximum of 4 keys to be played before running out of voices. When set to **4 voices** each key will trigger 4 voices, allowing a maximum of 2 keys to be played before running out of voices. When set to **full**, all 8 of the Ion's voices will be evenly divided among the keys that are held down.

#### Voice [edit]: Unison detune

**Page:** 1  
**Soft Button:** 2  
**Range:** 0-100  
**Default:** 0

This parameter detunes the Unison voices from one another. For example, with a Unison voices setting of **2 voices** and a Unison detune setting of **15**, voice 1 will be detuned +15 cents and voice 2 will be detuned -15 cents. In the same scenario with Unison voices set to **4 voices** or **full**, the Unison voices will be spread out between those limits. The higher the Unison detune setting, the more spread out the voices will be.

*Tip: to return quickly to page 1 while editing, perform a quick double-press of the [edit] button in that section.*

*Remember: to reset a parameter to its default value, perform a quick double-press of its Soft button.*

## Voice [edit]: P Wheel mode

**Page:** 1  
**Soft Button:** 3  
**Range:** held, all  
**Default:** all

The setting of this parameter dictates the response of the **(p)** wheel, which is normally assigned to pitch bend. When set to **all**, moving this wheel will bend the pitch of all voices that are sounding, even if they are being sustained by the **(sust pedal)** or are in their release stage.

When this parameter is set to **held**, only voices for which the keys are still depressed will allow their pitch to be bent by the **(p)** wheel. This is a great feature that can allow a keyboard player to bend notes in a chord independently, like a guitar player can. For example, if you play a three-note chord, step on the **(sust pedal)**, and release the top and bottom keys, you can bend the pitch of the note in the middle while the two released notes are being sustained at their original pitches.

## Voice: the [porta] button

This button toggles Portamento mode on and off. It also immediately takes you to Voice Edit page 2 with the Portamento Rate parameter selected. The four Portamento types and related parameters are described in the next paragraph and on the next page.

## Voice [edit]: Portamento type

**Page:** 2  
**Soft Button:** 1  
**Range:** fixed, scaled, gliss fixed, gliss scaled  
**Default:** fixed

*Tip: to return quickly to page 1 while editing, perform a quick double-press of the [edit] button in that section.*

Pressing the **[porta]** button turns on the Portamento feature, which is also sometimes called “glide.” This adds a very distinctive character to a sound, causing played notes to slide from one pitch to the next instead of changing only in “hard” intervals.

You have a choice of four different Portamento types:

<i>fixed</i>	No matter how far apart the two keys are, it takes the same amount of time to travel between them. The <b>Portamento time</b> parameter determines this amount of time.
<i>scaled</i>	Determines the amount of time it takes to glide a distance of one octave.
<i>gliss fixed</i>	The response between two keys is the same as for <i>fixed</i> , but the pitch travels in chromatic increments between the notes (C, C#, D, etc.).
<i>gliss scaled</i>	The response between two keys is the same as for <i>scaled</i> , but the pitch travels in chromatic increments between the notes (C, C#, D, etc.).

## Voice [edit]: Portamento time

**Page:** 2  
**Soft Button:** 2  
**Range:** 10 msec to 10 seconds  
**Default:** 160.22 msec

This parameter determines the length of time it takes for the Portamento feature to slide from note to note. The exact response is determined by the **Portamento type** parameter. See the previous parameter description for more information.

## Voice [edit]: Portamento trigger

**Page:** 2  
**Soft Button:** 3  
**Range:** normal, legato  
**Default:** normal

Portamento can be configured to respond in one of two ways to the way you play:

*legato* Portamento will occur only if you play a second key before lifting up the first key.

*normal* Portamento will occur even if there is no overlap between the lifting of one key and the playing of another.

## Voice: the [mono/poly] button

This button toggles between the mono and poly voice modes. Mono mode allows only one voice to be played. Poly mode allows polyphonic operation. Since it's a dedicated button with only two potential values, it doesn't call up a parameter in the display.

## LFO [edit]: Rate

**Page:** 1  
**Soft Button:** 1  
**Range:** 0.010 – 1000 hz or x 16 – x 1/16  
**Default:** 0.100 hz

This is where the initial rate for the selected LFO is set. Of course, the easiest way to edit this particular parameter is to grab the **rate** knob and turn it. That will take you immediately to this page.

Note that there are two possible sets of values listed for this parameter's range. The set of values you will have available is determined by the **sync** parameter on LFO edit page 1, Soft button 2.

The first Range (0.010 – 1000 Hz) is available if the Sync parameter is set to **off**. This means the LFO is not synchronized to the setting of the tempo parameter. As a result, the LFO may be set to any rate within the first range of values.

*Remember: to reset a parameter to its default value, perform a quick double-press of its Soft button.*

*The effect of the Portamento trigger parameter may be easier to see when a Program is in Mono mode.*

*Note: Although each LFO is entirely independent, their parameters are identical. Therefore, in discussing each parameter we will make no distinction between LFO 1 and LFO 2. Everything said about the parameters for either LFO applies equally to the other.*

*When LFO sync is set to off, LFO rate values are measured in Hz, or Hertz. This is a term meaning "cycles per second," and it is often referred to as the frequency of the LFO. A setting of 1000 Hz is well within the range of human hearing, so that rather than simply hearing the effect the LFO has on the pitch of an oscillator, the LFO itself can be heard as well.*

The second Range (x 1/16 – x 16) is provided if the Sync parameter is set to **on**. This means the LFO is synchronized to the setting of the tempo parameter. As the tempo changes, so will the rate of the LFO. But the difference here is that there is a rhythmic relationship between the tempo and the rate of the LFO. When the value is set to **x 1** (“times one”), the LFO will complete its cycle once per quarter note, relative to the tempo setting. When the value is set to **x 2**, the LFO will cycle once per eighth note. A value of **x 16** results in an LFO cycle of 1/64th note, and a value of **x 1/ 16** results in an LFO cycle equivalent to sixteen quarter notes, which are represented by four whole notes in the LCD graphics.

### LFO [edit]: Sync

**Page:** 1  
**Soft Button:** 2  
**Range:** tempo, off  
**Default:** off

As described in the section on LFO rate, this parameter determines whether the LFO is synchronized, or “slaved,” to the master tempo setting. For a complete description of how that affects the function of the LFO, refer to the previous parameter description.

### LFO [edit]: Reset

**Page:** 1  
**Soft Button:** 3  
**Range:** mono, poly, key-mono, key-poly  
**Default:** mono

The LFO Reset parameter dictates how the LFO will respond when the first key is pressed, and then determines how it will react to overlapping keypresses. There are four types of possible responses:

*mono* The LFO is shared between the voices of a Part. It may be at any point in its cycle when the first key is pressed. New voices will “ride” that LFO, joining other voices at the exact same point in the LFO’s cycle. The LFOs in each Part are independent of each other, so they can be running at different speeds.

*poly* Each voice’s LFO is completely independent of the others. When a key is pressed, that voice’s LFO may be at the top of its cycle, at the bottom, or anywhere else in the cycle when it begins to affect the voice. Some LFOs may be going in one direction (rising) while others are going in the opposite direction (falling).

*key-mono* The LFO is shared between the voices of a Part. When the first key is pressed, the LFO’s cycle resets to the beginning. When a second key is pressed, the LFO will reset its cycle to the beginning and start over.

*key-poly* Each voice has its own LFO that resets when the voice is triggered.

*Remember that if you want to edit the rate for one of the LFOs using the **rate** knob, you must first be sure the appropriate button has been pressed in the LFO section. The same is true for any LFO parameter you wish to edit.*

***Note:** It is possible to set the LFO sync values independently per LFO, so that one LFO is slaved to the tempo setting and the other LFO is “free running.”*

*Remember that it is possible to have the LFOs set independently, so that one LFO’s Reset parameter may be set to **poly**, for example, while the other’s is set to **key-mono**.*

## LFO [edit]: M1 to LFOx

Page:	2
Soft Button:	1
Range:	0-100%
Default:	0%

There are several ways to use an LFO, but the two main ways are as an expressive modulation source tied to one of the wheels, or as a constant modulation source for some aspect of the sound. This parameter determines whether the LFO will be used as one or the other, or as a blend of both.

If you want the LFO only available from **(m1)**, set this parameter to 100%. If you want the LFO to provide some amount of constant modulation regardless of the position of **(m1)**, set this parameter to something less than 100%. When this parameter is set to zero, the LFO will always be full-strength.

### LFO: the [1] button

This button selects LFO 1's parameters for editing. It also immediately takes you to LFO Edit page 1 with the LFO Rate parameter selected. For a description of the various LFO-related parameters, see the LFO [edit] sections on this and the previous page.

### LFO: the [2] button

This button selects LFO 2's parameters for editing. It also immediately takes you to LFO Edit page 1 with the LFO Rate parameter selected. For a description of the various LFO-related parameters, see the LFO [edit] sections on this and the previous page.

### LFO: the [s&h] button

This button selects the Sample & Hold's parameters for editing. It also immediately takes you to S&H Edit page 1 with the S&H Rate parameter selected. The Sample & Hold generator and its parameters are described in the following section.

*In order to use an LFO as a modulation source, you must use the mod matrix to designate a parameter as its destination. For more information, see Chapter 6.*



## Sample & Hold (S&H)

Most of the Sample & Hold's parameters are identical to those of the LFOs discussed on pages 45-46, so we will only list them and refer you to those pages. There are some important distinctions, though, and we will point those out.

### S&H [edit]: Rate

**Page:** 1  
**Soft Button:** 1  
**Range:** 0.010 – 1000 hz or x 16 – x 1/16  
**Default:** 0.100 hz

This is where the initial rate for the Sample & Hold is set. It determines the length of time between samples. If the **[s&h]** button is selected, you can edit the rate of the Sample & Hold by turning the **rate** knob. Doing so will also take you immediately to this page.

For an explanation as to why there are two sets of values listed for this parameter's Range, what they mean, and how to select between them, see the section **LFO [edit]: Rate** on page 44. See also the sidebars on that page for more information.

### S&H [edit]: Sync

**Page:** 1  
**Soft Button:** 2  
**Range:** tempo, off  
**Default:** off

This parameter determines whether the Sample & Hold is synchronized, or “slaved,” to the master tempo setting. For a complete description of how that affects the function of the Sample & Hold, refer to the section **LFO [edit]: Rate** on page 44 and the sidebars on that page as well.

### S&H [edit]: Input

**Page:** 1  
**Soft Button:** 3  
**Range:** see table  
**Default:** global random

The Input to the Sample & Hold determines the source of the S&H values. If the source is continuously active, like an LFO, there will be an endless supply of new values for the Sample & Hold to feed to its destination in the mod matrix. If the source is something more static like one of the wheels or pedals, the destination will receive new values from the Sample & Hold only after the value of the input is changed and another sample is taken.

On the next page is a chart that documents the Sources that are available as Inputs to the S&H generator.

#### *What does Sample & Hold mean?*

*Sample & Hold is a term that originated in the early days of analog modular synthesizers. It describes the process by which a reading, or “Sample,” is taken at regular intervals of a particular input source, such as an LFO. That Sample becomes a value that is fed to a destination, such as filter frequency. The destination parameter is held at this value until the “Hold” period has expired, at which time another Sample of the input source is taken and fed to the destination, and so on.*

*In order to use S&H as a modulation source, you must use the mod matrix to designate a parameter as its destination. For more information, see Chapter 6.*

Source	Description
None	No effect
Note-On Velocity	Velocity (how hard) the key is struck
Release Velocity	Velocity that the key is released.
Key Track	MIDI Key # used as modulator. MIDI note #60 is equivalent to 0.
M1 Wheel	Position Value of M1 Wheel, or incoming MIDI CC#00 message.
M2 Wheel	Position value of M2 wheel, or incoming MIDI CC as assigned
P Wheel	Position value of P wheel, or incoming MIDI Pitch Bend messages
Sustain Pedal	Position (Up/Down) of Sustain pedal, or incoming MIDI CC#64 messages
Expression Pedal	Position value of Exp pedal, or incoming MIDI CC as assigned
Amp Env Level	Amp Envelope Level
Filter Env Level	Filter Env Level
Pitch/Mod Env Level	Pitch/Mod Env Level
LFO 1 Sine	LFO 1 Sine output
LFO 1 Cosine	LFO 1 Sine output, phase shifted 90 degrees
LFO 1 Triangle	LFO 1 Triangle output
LFO 1 Cos-Triangle	LFO 1 Triangle output, phase shifted 90 degrees
LFO 2 Saw	LFO 1 Saw output
LFO 2 Cos-Saw	LFO 1 Saw output, phase shifted 90 degrees
LFO 1 Square	LFO 1 Square output
LFO 1 Cos-Square	LFO 1 Square output, phase shifted 90 degrees
LFO 2 Sine	LFO 1 Sine output
LFO 2 Cosine	LFO 1 Sine output, phase shifted 90 degrees
LFO 2 Triangle	LFO 1 Sine output
LFO 2 Cos-Triangle	LFO 1 Sine output, phase shifted 90 degrees
LFO 2 Saw	LFO 1 Sine output
LFO 2 Cos-Saw	LFO 1 Sine output, phase shifted 90 degrees
LFO 2 Square	LFO 1 Sine output
LFO 2 Cos-Square	LFO 1 Sine output, phase shifted 90 degrees
Voice Random	Random modulation source, unique to each voice
Global Random	Random modulation Source, common to all voices
Portamento Level	Level of Portamento output, as a percentage of the "glide" travel from starting note to ending note.
Portamento Effect	Portamento Level scaled by keyboard position, so that the modulation level follows the note's pitch.
Tracking Generator	Output of Tracking Generator, Interpolated
Step Track	Output of Tracking Generator, Stepped
MIDI Channel Pressure	Monophonic (per-MIDI Channel) Aftertouch, MIDI only
MIDI Aftertouch	Polyphonic (per-note) Aftertouch, MIDI only
MIDI CC 1...119	Value of incoming MIDI Continuous Controller messages

## S&H [edit]: Reset

**Page:** 2  
**Soft Button:** 1  
**Range:** mono, poly, key-mono, key-poly  
**Default:** mono

The S&H Reset parameter dictates how the Sample & Hold responds when the first key is pressed, and then determines how it will react to overlapping keypresses. For a full description of the Reset parameter, see the **LFO [edit]: Rate** section on page 45.

*Tip: to return quickly to page 1 while editing, perform a quick double-press of the [edit] button in that section.*

## S&H [edit]: Smoothing

**Page:** 2  
**Soft Button:** 2  
**Range:** 1-100%  
**Default:** 100%

This parameter governs the abruptness of the shift from the value of one sample to the value of the next. A low smoothing value causes the sample values to change instantly from one value to the next when the new sample is taken. A high smoothing value causes the Sample & Hold to “slide” from one value to the next.

*With Sample & Hold smoothing set to very high values, it is possible that very little or no change may be heard at the destination. If you're not hearing the desired amount of S&H, try increasing the smoothing value.*

## Tempo

The **tempo** knob is “command central” for anything that may be linked to tempo: the arpeggiator, an LFO, the Sample & Hold generator, or one of the time-based effects such as the rate of a chorus. The most obvious of these is the arpeggiator, so if you would like to see what the **tempo** knob does, activate the arpeggiator, hold down some notes, and turn the knob. Rotating the knob clockwise speeds up the arpeggiator, and rotating it counter-clockwise will slow the arpeggiator down. A tempo value is stored with each program.

*In a Setup, the program in Part A determines the tempo for all four parts. However, this will not be the case if the Global tempo source parameter is set to **Global**. In this case, the Tempo will be the same for all Programs and Setups. For more information, see Chapter 3 “Global Parameters.”*

Turning the **tempo** knob calls up arpeggiator Edit page 3 with the program tempo parameter selected. The tempo range is from 50-250 bpm (beats per minute). For more information about the arpeggiator, see the next page.

## Tempo: the [tap] button

The square backlit button under the **tempo** knob blinks according to the Tempo setting. But it serves as more than a visual metronome: if you tap the button at the desired tempo, it will adjust the Tempo setting to match what you are doing.

## The Arpeggiator

An arpeggio is what you get when the notes in a chord are played one at a time instead of all at once. The Ion's arpeggiator allows you to create automated arpeggios based on a combination of the notes you hold down and the settings of the arpeggiator. Of course, the easiest way to hear what the arpeggiator does is to press the **[on]** button and hold down one or more keys!

### Arp [edit]: Pattern

**Page:** 1  
**Soft Button:** 1  
**Range:** random, 1-31  
**Default:** 1

When arpeggiators were first introduced decades ago, the only thing they would do is “drone”; in other words, if you held down some keys the arpeggiator would play through those notes one after the other in a steady stream of evenly spaced notes. There was no rhythmic variation in an arpeggiator.

Not so in the Ion. You have a total of 32 rhythmically distinct arpeggiation patterns from which to choose. To try them out, press the **[on]** button and hold down one key. (Of course you can hold down more than one key, but the rhythms will be more obvious if you focus on one note at first.) After that, you can step through the options on this page using the **data** knob.

### Arp [edit]: Length

**Page:** 1  
**Soft Button:** 2  
**Range:** 2-16  
**Default:** 2

Each arpeggiator pattern is 2 bars long. Each of the bars is divided into 8 steps, for a total of 16 steps. The Length parameter allows you to determine how many of those 16 steps you will use. For example, if the first half of pattern 14 works very well in your song and the second half doesn't, set the pattern length to **8**. The rest of the pattern will still be there if you change your mind later; the Length parameter merely “covers it up.”

### Arp [edit]: Octave Range

**Page:** 1  
**Soft Button:** 3  
**Range:** 0-4  
**Default:** 0

Arpeggiators are often heard sending a cascade of notes from a high note to a low note, or from low notes to high notes. It is possible to have this happen without moving your hands, thanks to the Octave Range parameter.

*Note: the way the arpeggiator will respond from Part to Part within the Setup is determined by the Arp Retrigger setting in Global mode (Global Edit page 5, Soft button 2).*

*Before listening to the arpeggiator patterns, you may want to make sure the Length parameter is set to the maximum value of 16. This is found on Arp Edit page 1, Soft button 2. See the description of the next parameter on this page.*

*Note: Since there are eight steps in each bar of an arpeggiator pattern, that means that each step in the pattern is equal to an eighth note.*

*Note: When experimenting with the Octave Range parameter you may hear the extra sets of notes come in an octave lower, higher, or both, depending on the setting of the Octave Span parameter (as detailed in the next parameter description). For the sake of this example, we'll assume the Octave Span parameter has a value of **up**.*

For example, set the Octave Range value to **0**, turn on the arpeggiator and hold down three notes. You should hear those three notes being cycled by the arpeggiator. Next, change the Octave Range value to **1**. Now you should hear the original three notes followed by the same notes an octave higher. If you change the Octave Range to **2**, you will hear the original notes, the same notes one octave higher, and then the same notes another octave higher. Then the cycle will repeat.

## Arp [edit]: Octave Span

**Page:** 2  
**Soft Button:** 1  
**Range:** up, down, centered  
**Default:** centered

The Octave Span parameter determines whether the extra octaves of arpeggiation that are caused by the Octave Range parameter will sound below the notes that are held, above them, or both.

For example, set the Octave Range value to **1**, the Octave Span parameter value to **up**, turn on the arpeggiator and hold down three notes. You should hear those three notes followed by the same notes an octave higher. If you change the Octave Span to **down**, you will hear the original notes, and then the same notes one octave lower. If you change the Octave Span to **centered**, you will hear the notes you are holding played one octave lower than the original notes, and then you will hear the notes you are holding, followed by the same notes an octave higher. Then the cycle will repeat.

*Note: You will hear no change in the Octave Span parameter unless the Octave Range parameter is set to a value of at least 1 (as detailed in the previous parameter description).*

## Arp [edit]: Note Order

**Page:** 2  
**Soft Button:** 2  
**Range:** forward, reverse, trigger, r-n-r in, r-n-r x, oct jump  
**Default:** forward

As if the Arpeggiator weren't enough fun already, you can change the direction and other aspects of the arpeggiation to make the results less predictable. Here's a description of each setting:

<i>forward</i>	The Arpeggiator plays the notes you are holding from the bottom to the top. Once the top note is reached, the arpeggio begins from the bottom again.
<i>reverse</i>	The Arpeggiator plays the notes you are holding from the top to the bottom. Once the bottom note is reached, the arpeggio begins from the top again.
<i>trigger</i>	The Arpeggiator keeps track of which notes you played first and plays them back in that order. When the last note has been played, the arpeggio starts again.
<i>r-n-r in</i>	This stands for "rock & roll inclusive." It mixes the forward and reverse settings, playing up and down the notes you are holding and repeating the top note and the bottom note.

*Tip: to return quickly to page 1 while editing, perform a quick double-press of the [edit] button in that section.*

<i>r-n-r x</i>	This stands for “rock & roll exclusive.” It also mixes the forward and settings, but with one difference: it plays up and down the notes you are holding <i>without</i> repeating the top note and the bottom note.
<i>oct jump</i>	The Arpeggiator plays the notes you are holding, but plays the first note in two or more octave registers before playing the second note, which it also plays in two or more octave registers, etc.

*Note: when you select the **oct jump** value you will hear no change in the arpeggio unless the Octave Range parameter is set to a value of at least 1 (as detailed in the description of that parameter on pages 50-51).*

## Arp [edit]: Tempo Multiplier

<b>Page:</b>	2
<b>Soft Button:</b>	3
<b>Range:</b>	¼ - 4
<b>Default:</b>	1

With the default value of 1, the arpeggiator’s pattern tempo matches the system tempo. Since each step of an arpeggiator pattern represents an eighth note, you’ll hear two steps of the pattern with each flash of the tempo LED. Other values for this parameter cause the arpeggiator pattern to speed up or slow down accordingly. For example, setting this parameter to 4 will cause the arpeggiator to play 8 steps of its pattern with each flash of the tempo LED. At the other extreme of ¼, only half a step of the pattern will be played with each flash of the tempo LED.

*Rule of thumb: if the Tempo Multiplier is set to a value of 1 and the pattern is playing eighth notes during a given step, the notes will be happening twice as quickly as the tempo LED is flashing.*

## Arp [edit]: Program Tempo

<b>Page:</b>	3
<b>Soft Button:</b>	1
<b>Range:</b>	50.0 – 250.0
<b>Default:</b>	128

Each Program has a tempo value as a stored parameter. If the Global tempo source parameter is set to a value of **program** and this program is in Part A, then this parameter determines the tempo for the system. However, if the Global tempo source parameter is set to a value of **global**, then this parameter is not used.

*Remember: to reset a parameter to its default value, perform a quick double-press of its Soft button.*

## Arp: the [on] button

This button activates the Arpeggiator. If it is lit, the Arpeggiator is active. Its status is stored with the Program.

## Arp: the [latch] button

Pressing this button activates the Arpeggiator and also puts it into Latch mode. If it is lit, notes played on the keyboard will continue to arpeggiate after the keys are released. When a new note or chord is played, the old notes will be released and the Arpeggiator will latch the new note(s). The status of the **[latch]** button is stored with the Program.

The **(sust pedal)** may be used in conjunction with the **[latch]** button to add notes to the latched arpeggio.

## The Oscillators

### Osc [edit]: Waveform

**Page:** 1  
**Soft Button:** 1  
**Range:** sine, tri/saw, pulse  
**Default:** tri/saw

This is an oscillator's most important parameter. It determines the type of waveform that the oscillator produces, which is directly responsible for the fundamental character of the sound you hear. Each waveform type really represents a family of sounds; you will use the **Osc Shape** parameter, described below, to tell the Ion exactly what wave you want. **Sine** waves have a smooth, pure sound to them. **Tri/saw** can represent a triangle wave, a sawtooth wave, or anything in between. A triangle wave has a fuller sound than a sine wave, whereas a sawtooth wave has a harsh sonic character. **Pulse** is harmonically the richest of the three, and can range from a very full-sounding square wave to a sharp, nasally impulse wave. You can also adjust this parameter by pressing the button to the right of the **Osc [edit]** button.

### Osc [edit]: Shape

**Page:** 1  
**Soft Button:** 2  
**Range:** -100 - 100%  
**Default:** 0

Once you've selected your **Osc Waveform**, this parameter lets you bend the wave into just the sound you're listening for. How exactly it behaves depends on which waveform you've chosen. For the **sine** oscillator, a shape of zero gives you a pure tone. As you increase the shape, the sine wave deforms to add higher harmonics. Mathematically, the waveform is being raised to a continuously variable power, with 100% giving you what an engineer would call "sine to the fifth." But unless you're a mathematician, you probably care more about the sound than the equations, so grab the **shape** knob and take a listen. For the **tri/saw** oscillator, a shape of zero results in a triangle wave. As you adjust the shape, the wave leans left or right, ultimately becoming a down-saw or an up-saw at -100% or 100% respectively. With the **pulse** wave, the shape parameter controls the pulse width. A shape of zero gives you a square wave, and decreasing or increasing the shape will make your wave skinnier or fatter respectively.



*The Ion's three oscillators have the same basic characteristics and mostly the same parameters. However, there are a few extra parameters that deal with interactions between the oscillators, and these are found in Oscillator 1's parameter section. We'll go over the parameters common to all of the oscillators before taking a look at these cross-oscillator features.*

## Osc [edit]: Octave

**Page:** 1  
**Soft Button:** 3  
**Range:** -3 – 3  
**Default:** 0

This parameter lets you transpose the pitch of the oscillator up or down a number of octave. You can use this to get high pitches from low keys, or you can stagger the octaves of your three oscillators to create a very rich sound from a single note. The octave can also be adjusted using the **[octave up]** and **[octave down]** buttons, which appear as up and down arrows at the right of each oscillator section. Each time you press one of these buttons, the oscillator will be transposed up or down an octave, and the button will light up progressively more brightly. You can use the brightness of the light as a quick visual indication of whether your oscillator is octave-shifted, and by how much.

## Osc [edit]: Pitch Semitone

**Page:** 2  
**Soft Button:** 1  
**Range:** -7 – 7  
**Default:** 0

This parameter lets you transpose the pitch of the oscillator a number of chromatic half-steps. For example, if you set this parameter to **1** and play a C, you will hear a C#.

## Osc [edit]: Pitch Fine Tune

**Page:** 2  
**Soft Button:** 2  
**Range:** -99.5 – 99.5  
**Default:** 0

This parameter lets you transpose the pitch of the oscillator by half-cents. A cent is 1% of a semitone, so you might expect such tiny adjustments to be unnoticeable. However, if you have multiple oscillators playing together, small changes to relative tuning can have large effects. In particular, oscillators that are slightly detuned from one another can produce a much fuller sound than oscillators playing exactly in unison. For oscillators 2 and 3, tuning can also be adjusted with the **pitch** knob, to the right of the **shape** knob. If you use the knob to push **Osc Pitch Fine Tune** past 99.5, then **Osc Pitch Semitone** will be incremented and the fine tune will wrap around to zero.

*Remember: to reset a parameter to its default value, perform a quick double-press of its Soft button.*



## Osc [edit]: Pitch Wheel Range

**Page:** 2  
**Soft Button:** 2  
**Range:** 0 – 12  
**Default:** 2

This parameter determines how many semitones the **(p)** wheel can bend the pitch of the oscillator. If you set it to zero, the **(p)** wheel will have no direct effect on the pitch (although the **(p)** wheel can still be used in the Mod Matrix; see Chapter 6). The default of 2 allows you to bend up and down a full-step, which is what you normally expect from a synthesizer's pitch wheel. At the maximum of 12, the wheel will send your oscillator up or down a full octave.

## Osc 1 [edit]: FM Level

**Page:** 3  
**Soft Button:** 1  
**Range:** 0 – 100%  
**Default:** 0

This is the first of the cross-oscillator parameters that can be found on the extra pages in Oscillator 1's parameter section. The Ion's **Osc FM**, or "frequency modulation", feature allows you to use one oscillator to control the frequency of another. The **FM Level** parameter determines the amount by which the target oscillator's frequency is affected by the master oscillator's waveform. What exactly the level means depends on the **FM Type**, as you'll see below, but at zero, there is never any frequency modulation at all.

## Osc 1 [edit]: FM Type

**Page:** 3  
**Soft Button:** 2  
**Range:** linear, exponential  
**Default:** 0

This parameter selects the style of modulation used by the **Osc FM** feature. With **linear** FM, the waveform of the master oscillator is added to the phase of the target oscillator. The **FM Level** parameter controls the "modulation index", with a level of 100% providing an index of 32. Linear FM is the style used by typical FM music synthesizers. Modulating a sine wave with another, higher-frequency sine wave produces a fundamental frequency with a variety of overtones, and this can be used to reproduce the sounds of many physical musical instruments. With **exponential** FM, the waveform of the master oscillator modulates the pitch of the target oscillator. The **FM Level** parameter controls the range of pitch, with a level of 100% driving the pitch up and down a full six octaves. You can also set the **FM Level** by grabbing the **fm** knob, to the right of Oscillator 1's **octave up/down** buttons.

*Tip: to return quickly to page 1 while editing, perform a quick double-press of the [edit] button in that section.*

## Osc 1 [edit]: FM Config

**Page:** 3  
**Soft Button:** 3  
**Range:** 3->2->1, 3->1<-2, 2->1  
**Default:** 2->1

This parameter lets you choose what the source and target oscillators are for FM. In the **3->2->1** configuration, Oscillator 3 modulates Oscillator 2, and Oscillator 2 in turn modulates Oscillator 1. With the **3->1<-2** configuration, Oscillators 2 and 3 combine to both modulate Oscillator 1. In the **2->1** configuration, Oscillator 2 modulates Oscillator 1, and Oscillator 3 does not participate in FM. In the configurations with multiple modulation routes, all modulation uses the same **FM Level** and **FM Type**.

## Osc 1 [edit]: Sync Osc

**Page:** 4  
**Soft Button:** 1  
**Range:** osc 2, osc 2 + 3  
**Default:** osc 2

Whereas FM lets you use Oscillators 2 and 3 to affect Oscillator 1, Ion's **Osc Sync** feature allows you to turn around and use Oscillator 1 to affect Oscillators 2 and 3. The **Sync Osc** parameter determines which oscillators are synced to Oscillator 1 when the **Osc Sync** feature is enabled. If set to **osc 2**, only Oscillator 2 will be affected by **Osc Sync**. If set to **osc 2 + 3**, then both Oscillators 2 and 3 will be slaves to Oscillator 1.

## Osc 1 [edit]: Sync Type

**Page:** 4  
**Soft Button:** 2  
**Range:** hard, soft  
**Default:** hard

This parameter determines the style of syncing that the **Osc Sync** feature uses. **Hard** sync resets the slave oscillator to the beginning of its waveform whenever the master oscillator (Oscillator 1) hits the beginning of its waveform. This has the effect of forcing the master's fundamental frequency onto the slave. This behavior is called "hard sync" because the slave waveform is "snapped" to zero at the frequency of the master oscillator, which can create a harsh, rough sound even out of sine waves. **Soft** sync, on the other hand, reverses the direction of the slave oscillator whenever the master hits the beginning of its waveform. The resulting wave has no sharp edges, as it does with hard sync, but exhibits a mixture of harmonics that can have interesting sonic properties.

## Osc 1: the [osc sync] button

This button toggles **Osc Sync** on and off. You will know that **Osc Sync** is enabled if the button is lit up. Pressing the button also immediately takes you to Osc 1 Edit page 4 with the **Sync Type** parameter selected.

### The Pre Filter section

#### Pre Filter Mix [edit]: Osc 1 Level

**Page:** 1  
**Soft Button:** 1  
**Range:** 0 – 100%  
**Default:** 50%

This parameter is the first of the levels in the Pre Filter Mix, which provides you a virtual mixing board for adjusting the strengths of the Ion's various signal sources before they are sent to the filters. The **Osc 1 Level** parameter controls how much of Oscillator 1 will appear at the inputs of the filters. This parameter can also be adjusted with the **1** knob in the **Pre Filter Mix** section on the top panel.

#### Pre Filter Mix [edit]: Osc 2 Level

**Page:** 1  
**Soft Button:** 2  
**Range:** 0 – 100%  
**Default:** 50%

This parameter controls the level of Oscillator 2 in the Pre Filter Mix. It can also be adjusted with the **2** knob in the **Pre Filter Mix** section on the top panel.

#### Pre Filter Mix [edit]: Osc 3 Level

**Page:** 1  
**Soft Button:** 3  
**Range:** 0 – 100%  
**Default:** 50%

This parameter controls the level of Oscillator 3 in the Pre Filter Mix. It can also be adjusted with the **3** knob in the **Pre Filter Mix** section on the top panel.

#### Pre Filter Mix [edit]: Ring Mod Level

**Page:** 2  
**Soft Button:** 1  
**Range:** 0 – 100%  
**Default:** 50%

This parameter controls the level of the Ring Mod source in the Pre Filter Mix. Ring Mod is generated by multiplying the waveforms of Oscillators 1 and 2. This parameter can also be adjusted with the **ring mod** knob in the **Pre Filter Mix** section on the top panel.

### Pre Filter Mix [edit]: External Input Level

**Page:** 2  
**Soft Button:** 2  
**Range:** 0 – 100%  
**Default:** 50%

This parameter controls the level of the External Input source in the Pre Filter Mix. This allows you to feed an external audio signal into the Ion and process it using the Ion's powerful filters and effects, and even play your external signal as if it were an instrument. The parameter can also be adjusted by pressing the **[ext in]** button on the top panel, and turning the knob that is located immediately to the left of it.

### Pre Filter Mix [edit]: Noise Level

**Page:** 2  
**Soft Button:** 3  
**Range:** 0 – 100%  
**Default:** 50%

This parameter controls the level of the Noise source in the Pre Filter Mix. The character of the noise is determined by the **Noise Type** parameter, described later. This parameter can also be adjusted by pressing the **[noise]** button on the top panel, and turning the knob that is located immediately to the left of it.

### Pre Filter Mix [edit]: Osc 1 Balance

**Page:** 3  
**Soft Button:** 1  
**Range:** 0%/100% – 100%/0%  
**Default:** 50%/50%

While the **level** parameters control the strength of the signal source in the Pre Filter Mix, the **balance** parameters let you determine how much of that signal gets sent to Filter 1 and how much goes to Filter 2. A balance of 100%/0% means that all of this source is fed to Filter 1, 0%/100% sends the source completely to Filter 2, and 50%/50% sends an equal amount into both filters. The **Osc 1 Balance** parameter controls the balance of the Oscillator 1 source.

### Pre Filter Mix [edit]: Osc 2 Balance

**Page:** 3  
**Soft Button:** 2  
**Range:** 0%/100% – 100%/0%  
**Default:** 50%/50%

This parameter controls the filter balance of Oscillator 2 in the Pre Filter Mix.

*Tip: to return quickly to page 1 while editing, perform a quick double-press of the [edit] button in that section.*

### Pre Filter Mix [edit]: Osc 3 Balance

**Page:** 3  
**Soft Button:** 3  
**Range:** 0%/100% – 100%/0%  
**Default:** 50%/50%

This parameter controls the filter balance of Oscillator 3 in the Pre Filter Mix.

### Pre Filter Mix [edit]: Ring Mod Balance

**Page:** 4  
**Soft Button:** 1  
**Range:** 0%/100% – 100%/0%  
**Default:** 50%/50%

This parameter controls the filter balance of the Ring Mod source in the Pre Filter Mix.

### Pre Filter Mix [edit]: External Input Balance

**Page:** 4  
**Soft Button:** 2  
**Range:** 100% f1 – 100% f2  
**Default:** center

This parameter controls the filter balance of the External Input source in the Pre Filter Mix. However, since the External Input is a stereo source, this balance works a little differently. When the balance is exactly in the middle, the left channel of the external input is sent to Filter 1, and the right channel is sent to Filter 2. As the parameter is increased, the left external input is shifted towards Filter 2, until at the maximum setting of 100% f2, both external audio sources are sent only to Filter 2. Conversely, decrementing the parameter shifts the right signal toward Filter 1, and at the 100% f1 setting, both external audio sources are sent only to Filter 1.

### Pre Filter Mix [edit]: Noise Balance

**Page:** 4  
**Soft Button:** 3  
**Range:** 0%/100% – 100%/0%  
**Default:** 50%/50%

This parameter controls the filter balance of the Noise source in the Pre Filter Mix.



## Pre Filter Mix [edit]: Noise Type

**Page:** 5  
**Soft Button:** 1  
**Range:** white, pink  
**Default:** pink

This parameter selects the type of noise that Ion's noise source produces. **White** noise is characterized by having the same amount of energy across all frequencies, and it sounds like a hiss or radio static. **Pink** noise is characterized by having the same amount of energy in each octave, and it sounds like a roar or ocean wave. White noise has a sharp sound which makes it especially good for percussive effects, whereas the frequency characteristics of pink noise are more soothing and pleasant to the human ear.

## Pre Filter Mix [edit]: f1 -> f2 Level

**Page:** 5  
**Soft Button:** 2  
**Range:** 0 – 100%  
**Default:** 0

Filter 2 has one additional input that is not available to Filter 1. Namely, the input mix of Filter 2 can include the output of Filter 1 itself. The **f1->f2 Level** parameter controls how much of the output of Filter 1 is fed into input of Filter 2. This allows you to cascade the two filters, one after the other. If you shift the oscillator balances toward Filter 1 and then turn up this parameter, you are effectively routing the Ion's filters in series.

## The Filters

### Filter [edit]: Type

**Page:** 1  
**Soft Button:** 1  
**Range:** 17 filter types + bypass  
**Default:** bypass

This section ranks with the oscillators as being the biggest contributor to the sound of the Ion. Even identical oscillator settings will sound radically different as you change the filter types. We have gone to great length to emulate the classic filter sounds of the most famous analog synthesizers. There are 18 choices here, with 17 filter types and a filter bypass choice available:

#### bypass

No filter. This setting is useful for previewing the un-filtered signal.

#### mg 4-pole lowpass

Modeled on the filter found in the most famous monophonic analog synth ever made. The filter, with a steep cutoff and deep resonance, earned much credit for its fat sound. This filter will self-oscillate at high resonance settings.

*With the exception of Filter 2's **offset** button, the parameters available to the Ion's two filters are exactly the same. Therefore, we will go over the parameters in the **Filter** section without making a distinction between Filter 1 and Filter 2.*

**ob 2-pole lowpass**

Modeled on the lowpass output of the multi-mode filter built into a classic synthesizer expander module.

**ob 2-pole bandpass**

Modeled on the bandpass output of the ob multi-mode filter.

**ob 2-pole highpass**

Modeled on the highpass output of the ob multi-mode filter.

**rp 4-pole lowpass**

Modeled on the filter in a very popular semi-modular synth. This filter will clip (distort) when fed a loud input level.

**tb 3-pole lowpass**

Modeled on the filter from a little silver bass synthesizer whose sound has become ubiquitous in many styles of electronic music.

**jp 4-pole lowpass**

Modeled on the lowpass filter from a popular 8-voice synth noted for its very colorful case and colorful, versatile sound. Compare its sound to the mg or rp filters.

**8-pole lowpass**

Unique to the Ion. 8 poles give this filter an extremely steep cutoff.

**8ve dual bandpass**

Unique to the Ion. Two 2-pole bandpass filters, spaced 1 octave apart.

**6-pole bandpass**

Unique to the Ion. This filter sounds like an exaggerated version of the ob bandpass.

**phase warp**

Unique to the Ion. This is based on an analog phaser effect. Eight allpass filters in series create four harmonically related notches in the frequency response.

**comb filter 1**

Unique to the Ion. The comb filter creates multiple resonant peaks and notches that are not harmonically related.

**comb filter 2**

Similar to comb filter 1, but the signal is additionally filtered to reduce the “metallic” sound.



**vocal formant 1**

Unique to the Ion. Formant filters are modeled on the human voice. This 3-band (3 bandpass filters) version emulates the “ah” and “oo” vowel sounds.

**vocal formant 2**

Unique to the Ion. A 3-band formant filter which emulates the “oh” and “ee” vowel sounds.

**vocal formant 3**

Unique to the Ion. A 5-band formant filter based on an idealized model of the vocal tract.

**band limit**

Unique to the Ion. A 2-pole highpass filter and a 2-pole lowpass filter in series, limiting the signal to everything in between them. The resonance control adjusts the bandwidth.

**Filter [edit]: Frequency**

**Page:** 1  
**Soft Button:** 2  
**Range:** 20 Hz – 20 KHz or -4.0 to 4.0 octaves  
**Default:** 20 KHz or +4.0 octaves

This parameter sets the cutoff frequency for the filter. Depending on the filter type, the cutoff frequency is either the point above or below which the audio frequencies begin to diminish. In some filter types there are actually multiple frequencies emphasized and/or reduced; sweeping the frequency in this case shifts them all at once.

**Filter 2: the [offset] button**

This button toggles Filter 2’s frequency knob between Absolute and Offset modes. In Absolute mode, Filter 2’s frequency knob functions identically to Filter 1’s and adjusts the filter frequency. In Offset mode, Filter 2’s frequency is a multiple of Filter 1’s such that adjusting or modulating Filter 1’s frequency also adjusts Filter 2’s. In Offset mode adjusting Filter 2’s frequency adjusts the constant amount by which it is offset from Filter 1. See the sidebar notes for more information.

**Filter [edit]: Resonance**

**Page:** 1  
**Soft Button:** 3  
**Range:** 0-100%  
**Default:** 0

An increase in this parameter adds emphasis to the current filter frequency. At its higher settings, the sound can begin to “whistle,” or self-oscillate.

**Filter 2 and Offset mode**

*If the [offset] button has been pressed, the frequency value for Filter 2 will be displayed in terms of its relationship to Filter 1’s frequency. A setting of +1.0 octaves means Filter 2’s frequency is one octave higher than Filter 1’s, so when Filter 1’s frequency is 220 Hz then Filter 2’s frequency will be 440 Hz.*

***Note:** When it is offset from Filter 1, Filter 2 follows the Envelope Amt and Key Track settings of Filter 1. If you also use these controls for Filter 2, this will compound the impact of these parameters and affect the Offset relationship of the filters.*



## Filter [edit]: Key Track

**Page:** 2  
**Soft Button:** 1  
**Range:** -100 to +200%  
**Default:** +100

This parameter adjusts the way the filter follows, or “tracks” the keyboard. A setting of **0** means the filter frequency will remain constant across the keyboard. If the key track parameter is set to **+100**, the filter tracks the keyboard perfectly, and with enough resonance, can be played as if it were an oscillator. Negative settings mean the filter will grow darker as higher notes are played.

*Remember: to reset a parameter to its default value, perform a quick double-press of its Soft button.*

## Filter [edit]: Envelope Amount

**Page:** 2  
**Soft Button:** 2  
**Range:** -100 to +100%  
**Default:** 0

This parameter determines how much the filter frequency will be affected by the filter envelope. A negative setting allows for inverted envelopes.

## The Post Filter Mix section

### Post Filter Mix [edit]: Filter 1 Level

**Page:** 1  
**Soft Button:** 1  
**Range:** 0-100%  
**Default:** 0

This parameter controls how much of Filter 1 will be sent to the output stage, relative to Filter 2 and the Pre Filter Level.

### Post Filter Mix [edit]: Filter 2 Level

**Page:** 1  
**Soft Button:** 2  
**Range:** 0-100%  
**Default:** 0

This parameter controls how much of Filter 2 will be sent to the output stage, relative to Filter 1 and the Pre Filter Level.

### Post Filter Mix [edit]: Pre Filter Level

**Page:** 1  
**Soft Button:** 3  
**Range:** 0-100%  
**Default:** 0

This parameter controls how much of the Pre Filter send will be sent to the output stage, relative to Filters 1 and 2. The source of the Pre Filter send is selected on Post Filter Mix page 3, Soft button 2.

**Post Filter Mix [edit]: Filter 1 Pan**

**Page:** 2  
**Soft Button:** 1  
**Range:** 1-100% left, center, 1-100% right  
**Default:** center

This parameter determines the balance of Filter 1 between the left and right outputs.

**Post Filter Mix [edit]: Filter 2 Pan**

**Page:** 2  
**Soft Button:** 2  
**Range:** 1-100% left, center, 1-100% right  
**Default:** center

This parameter determines the balance of Filter 2 between the left and right outputs.

**Post Filter Mix [edit]: Pre Filter Pan**

**Page:** 2  
**Soft Button:** 3  
**Range:** 1-100% left, center, 1-100% right  
**Default:** center

This parameter determines the balance of the Pre Filter send between the left and right outputs. The source of the Pre Filter send is selected on Post Filter Mix page 3, Soft button 2.

**Post Filter Mix [edit]: Filter 1 Polarity**

**Page:** 3  
**Soft Button:** 1  
**Range:** positive, negative  
**Default:** positive

This parameter makes it possible to negate the polarity of Filter 1's output. This will change its phase relationship with the Filter 2 and Pre Filter signals, creating peaks and notches at various frequencies.

**Post Filter Mix [edit]: Pre Filter Signal**

**Page:** 3  
**Soft Button:** 2  
**Range:** osc 1, osc 2, osc 3, flt 1 input mix, flt 2 input mix, ring mod, noise  
**Default:** osc 1

This parameter determines the source of the Pre Filter signal. You can select between the unfiltered outputs of the oscillators, the blend of the Pre Filter sources before it heads into one of the filters, the unfiltered output of the ring modulator, or the unfiltered output of the noise generator.

## The Output section

### Output [edit]: Drive Type

**Page:** 1  
**Soft Button:** 1  
**Range:** 6 drive types + bypass  
**Default:** bypass

Even after your sound has gone through the Post Filter Mix, there's still one more place to give it a boost and add some extra character and flavor. The drive effect is an insert effect, and takes over after the amp envelope but before the program level has been applied. The Ion's drive effects are designed to model the sorts of boxes you would normally put at the end of your signal chain, and you get to choose one of seven types:

<i>bypass</i>	Allows the signal to pass through without being processed.
<i>compressor</i>	Modeled on a solid state compressor. It has a medium attack time, to add a little “snap” to the signal.
<i>rms limiter</i>	Modeled on a classic optical limiter with a slow attack setting. It increases the overall loudness of the signal and emphasizes the transients (“attack”).
<i>tube overdrive</i>	Modeled on the “soft” distortion of a tube (valve) mic preamp.
<i>distortion</i>	Modeled on the “harder” distortion of a solid state mic preamp.
<i>tube amp</i>	Modeled on a heavily distorted tube (valve) guitar amplifier.
<i>fuzz pedal</i>	Modeled on a heavily distorted guitar fuzz pedal.

### Output [edit]: Drive Level

**Page:** 1  
**Soft Button:** 2  
**Range:** 0 – 100%  
**Default:** 0

This parameter lets you select how strongly you want to drive the particular drive effect that you are using. When **Drive Level** is set to zero, all drive types function as a bypass; that is, they do not affect the sound at all. As this parameter is increased, the drive effect is driven harder and affects your sound more heavily. This parameter can also be adjusted by grabbing the **drive** knob.

## Output [edit]: Effects Send Level

Page:	1
Soft Button:	3
Range:	0 – 100%
Default:	0

This parameter determines how much of this program is sent off to the Ion's dedicated effects processor. When set to zero, the effects processor is given nothing at all. When set to 100%, the full output of each voice is available for the effects processor to play with. For complete details on how to put the Ion's effects to work, see Chapter 7. This parameter can also be adjusted by turning the **effects** knob.

## Output [edit]: Program Level

Page:	2
Soft Button:	1
Range:	0 – 100%
Default:	0

This simple but very important parameter controls how loud your program is. When set to zero, the program is silent, whereas a setting of 100% will play it full-blast. If you hear your sound clipping, this is a good parameter to reach for. You can also use this parameter to equalize the loudness of the various programs you create, so they all sound about the same level as you flip through them, regardless of their individual oscillator, filter, and mixer settings. This parameter can be adjusted by turning the **level** knob.

## The Envelopes

### Env [edit]: Attack Time

Page:	1
Soft Button:	1
Range:	0.5 ms – 30 sec
Default:	0.5 ms

This parameter determines the length of the attack stage of the envelope. This is the amount of time it takes for the envelope's level to rise from its starting value to zero to its full-strength value of 100%. If you want your sound to have a percussive snap when the note is hit, you can set the amp envelope's **Attack Time** to a very small value. Low to mid-range values will bring in your sound without the snap, and large values will let your sound fade in gradually. This parameter can also be adjusted by pressing the appropriate envelope button (**[amp]**, **[filter]**, or **[pitch/mod]** for the amp, filter, or pitch/mod envelopes respectively) and turning the **attack** knob.

*The Ion's three envelopes have identical parameters. Although a couple of the envelopes are "hard-wired" to various destinations, the process of editing each envelope is the same. Also, don't forget that the three envelopes behave identically when used in the mod matrix. See Chapter 6.*

## Env [edit]: Attack Slope

**Page:** 1  
**Soft Button:** 2  
**Range:** linear, +exp, -exp  
**Default:** linear

In the attack stage, the envelope's level always rises from zero to 100%. This parameter lets you specify how it gets there. A **linear** slope goes straight from point A to point B, and is your general plain-vanilla envelope slope. A **+exp** slope is bowed upward—it rises quickly at first and then trails off. This mimics the charging characteristics of electronic capacitors, which were used to generate envelopes in vintage analog synths. This slope is good for making your attacks extra-snappy. A **-exp** slope is bowed downward—it starts off slowly and bursts up at the end. If you are designing a sound to build toward a crescendo, this might be slope you need. You don't need to learn the names of these slopes, though, since you can always see your envelope pictured on the display as you edit it. Just scroll through the slopes until you see the one that looks right.

## Env [edit]: Decay Time

**Page:** 1  
**Soft Button:** 3  
**Range:** 0.5 ms – 30 sec  
**Default:** 0.5 ms

This parameter determines the length of the decay stage of the envelope. This is the amount of time it takes for the envelope's level to drop from 100% at the height of the attack down to the sustain level. This parameter can also be adjusted by pressing the appropriate envelope button and turning the **decay** knob.

## Env [edit]: Decay Slope

**Page:** 2  
**Soft Button:** 1  
**Range:** linear, +exp, -exp  
**Default:** linear

This parameter lets you specify the slope for the decay stage of the envelope. The slopes are similar to those for the attack: a **linear** slope is a straight line, a **+exp** slope starts out fast and trails off, like a capacitor, and a **-exp** slope starts out slow and builds up speed as it goes.



## Env [edit]: Sustain Level

Page:	2
Soft Button:	2
Range:	0 – 100% or -100% – 100%
Default:	100%

Unlike the attack stage, which always brings the envelope level up to 100%, the decay stage can be told to leave the envelope level wherever you like. The **Sustain Level** parameter lets you specify what the level should be as the envelope completes its decay and moves into the sustain stage. You may set this to 100% to make the decay stage flat, or 0% to make the sustain stage flat, but more often you'll leave it somewhere in the middle. This allows you to model the dynamics of a note being struck and then ringing out. For the filter and pitch/mod envelopes, this parameter can even be negative. Since the subsequent envelope stages always head back towards zero, a negative sustain level will give you an envelope that zigs high, zags low, and ends up somewhere in the middle. This parameter can also be adjusted by pressing the appropriate envelope button and turning the **sust level** knob.

## Env [edit]: Sustain Time

Page:	2
Soft Button:	3
Range:	0.5 ms – 30 sec, hold
Default:	hold

This parameter determines the length of the sustain stage of the envelope. If you are familiar with analog synths, this parameter may surprise you, since a traditional synth will remain in the sustain stage as long as you have the note held down. The Ion provides this behavior, of course—simply set this parameter to “hold”, and your note will be sustained until your finger gets tired. But many physical instruments do not work like this. A piano, for example, exhibits a distinct attack and decay as the hammer strikes the string, but the string does not then ring forever—the volume slowly diminishes until the string is silent. The Ion allows you to model this behavior by specifying a sustain time. This is the amount of time it takes for the envelope level to drop from the sustain level to zero. Once the envelope has sustained to zero, the envelope has completed and will remain at zero. When the amp envelope has sustained to zero, that means the entire note has completed and will no longer use one of the synth's voices. This parameter can also be adjusted by pressing the appropriate envelope button and turning the **sust time** knob.

## Env [edit]: Release Time

**Page:** 3  
**Soft Button:** 1  
**Range:** 2.0 ms – 30 sec, hold  
**Default:** 2.0 ms

This parameter determines the length of the release stage of the envelope. This is the amount of time from when you release a note to when the envelope level reaches zero. The starting level of the release stage is whatever the envelope level was when the note was released. Unless your note has fully sustained to zero and disappeared (or the **Freerun** parameter is active, as you'll see below), releasing a note will immediately move all envelopes to the release stage. Once the amp envelope has gone through its release time, that means the note has completed and will no longer use one of the synth's voices. This parameter also can be adjusted by pressing the appropriate envelope button and turning the **release** knob.

A setting of **hold** means that after the key is released, the envelope will stay at its current level indefinitely. The note will continue to sound until the voice is stolen or the Release Time value is reduced, allowing the sound to fade out.

## Env [edit]: Release Slope

**Page:** 3  
**Soft Button:** 2  
**Range:** linear, +exp, -exp  
**Default:** linear

This parameter lets you specify the slope for both the sustain and the release stages of the envelope. The slopes are similar to those for the attack and decay stages: a **linear** slope is a straight line, a **+exp** slope starts out fast and trails off, and a **-exp** slope starts out slow and builds up speed as it goes.

*Keep in mind that the Release Slope setting affects the slope for both the sustain and release stages.*

## Env [edit]: Keyboard Velocity Track

**Page:** 3  
**Soft Button:** 3  
**Range:** 0 – 100%  
**Default:** 100%

This parameter determines how much the note velocity, or how hard you hit the key, affects the envelope. When set to zero, the envelope always comes out full-strength, regardless of how lightly you hit the key. When set to 100%, the amplitude of the envelope directly matches the velocity, and very light keystrokes will result in very weak envelopes. Parameter values in the middle scale accordingly. In all cases, a hard keystroke produces a strong envelope; this parameter just lets you choose the envelope strength for weak keystrokes.

*Remember: to reset a parameter to its default value, perform a quick double-press of its Soft button.*

**Env [edit]: Reset**

**Page:** 4  
**Soft Button:** 1  
**Range:** reset, legato  
**Default:** reset

This parameter determines where your envelope starts when you play a note. When set to **reset**, the envelope always starts from the beginning of the attack stage, no matter what. But when set to **legato**, if you play a note while holding down another note, the envelope starts from the same position that the held note's envelope. For a program in **mono** voice mode, this means that playing "legato" (playing a new note before releasing the previous note) makes the voice transpose to each note's pitch over a continuous envelope, while playing "staccato" (releasing each note before playing the next one) makes each note attack individually. This behavior allows you a great deal of expressive control as you play. For a program in **poly** voice mode, all notes will share the same envelope, and this envelope will be reset only if you play a note with no other notes held down. This feature is especially useful with the filter envelope. Not only will it ensure that filter sweeps happen in unison across all of the notes you play, but you can prevent the filter from sweeping at all as long as you have a note held down, so you can keep this effect under your hat until you're ready to bring it out.

**Env [edit]: Freerun**

**Page:** 4  
**Soft Button:** 2  
**Range:** release, freerun  
**Default:** release

This parameter determine the sustaining behavior of the envelope. If set to **release**, then the envelope transitions from the attack stage to the decay stage to the sustain stage, as long as you are holding the key down. As soon as you take your finger off the key, the envelope will move into

*Tip: to return quickly to page 1 while editing, perform a quick double-press of the [edit] button in that section.*

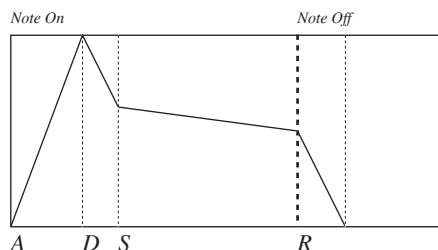
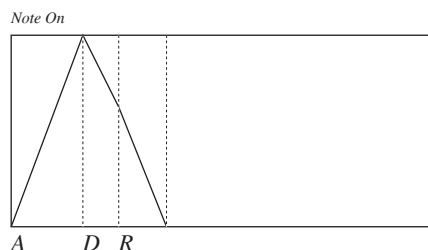
**"Release" mode****"Freerun" mode**

the release stage. If this parameter is set to **freerun**, then there is no sustain stage—the envelope transitions from attack to decay to release. Furthermore, it doesn't matter how long you hold down the key; the envelope always follows this fixed-length pattern. If you are using the



**Loop** feature of the envelope, this parameter will have further effects on the envelope behavior, and these will be discussed below.

## Env [edit]: Loop

**Page:** 4  
**Soft Button:** 3  
**Range:** decay, zero, hold, off  
**Default:** off

Under normal circumstances, you'll want your envelope to go straight through its stages, from attack to decay to sustain and/or release. But sometimes, you'll want the envelope to loop back on itself and go through some stages more than once. That's what this parameter is for. When set to **decay**, the envelope will go through its attack and decay stages like usual, but will then loop back to the beginning of the attack stage. It will continue looping through the attack and decay stages as long as the note is held. If the envelope is in **Freerun** mode, it will even continue looping after you release the note. You will usually only want to use this configuration with your filter or pitch/mod envelopes; if you set up the amp envelope to loop forever, you'll only be able to stop it by playing a lot of other notes at once to steal the voice.

### Loop decay: "Release" mode

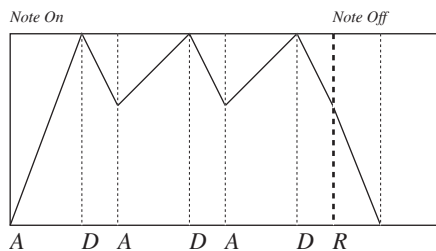

### Loop decay: "Freerun" mode

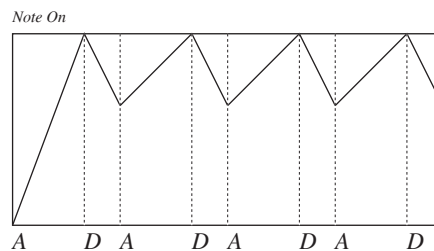

When **Loop** is set to **zero**, the envelope will loop through the attack, decay, and sustain stages as long as the note is held down. When the note is released, the envelope will loop through the attack, decay, and release stages. If you set your sustain and release times to different values, this will allow your envelope to have different cycle times depending on whether the note is held down or not. Setting sustain time to **Hold** will even cause your envelope to start looping only after the note has been released! When **Freerun** is active, the envelope will skip the sustaining and go straight to the attack, decay, release loop.

*Be careful! Setting **Loop** to **zero** will always cause your envelope to loop forever, regardless of the **Freerun** parameter.*

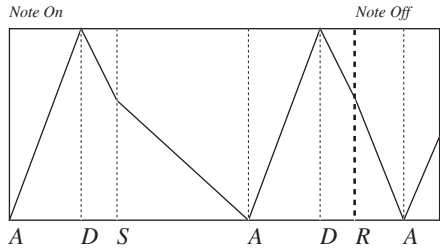
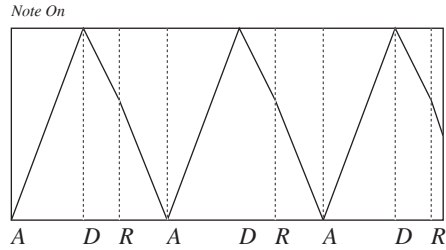

**Loop zero: “Release” mode****Loop zero: “Freerun” mode**

When **Loop** is set to **held**, the behavior will be identical to **zero** as long as the note is held down, but when the note is released, the envelope will move to the release stage and finish up. This is the only mode in which an envelope in **Freerun** mode reponds to a note being released.

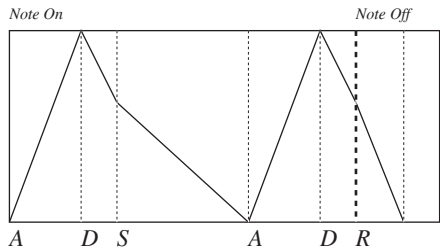
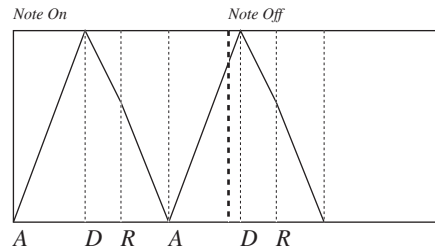
**Loop hold: “Release” mode****Loop hold: “Freerun” mode****Env [edit]: Sustain Pedal**

**Page:** 5  
**Soft Button:** 1  
**Range:** on, off  
**Default:** on

This parameter determines whether the envelope is affected by the sustain pedal. When **on**, if you press the sustain pedal and release a key, the Ion will pretend that you still have the note held down, and will not move the envelope to the release stage until you let up on the pedal. When **off**, the sustain pedal will not affect the behavior of the envelope. Note that, regardless of this setting, features that depend on “legato” playing are unaffected by the sustain pedal. In order to trigger a legato effect, you must actually have two keys held down with your fingers.

## What is the Mod Matrix?

The Modulation Matrix is where all of the previously discussed voice elements—envelopes, oscillators, and filters, and so on—interact with each other to make a powerful, expressive synthesizer voice. It is essentially a set of 12 virtual patch cables that can be used to connect a large selection of **Source** modifiers to **Destination** parameters. This is the central hub where the LFOs and envelopes allow you to create more complex patches. The Mod Matrix parameter settings are unique to each Program.

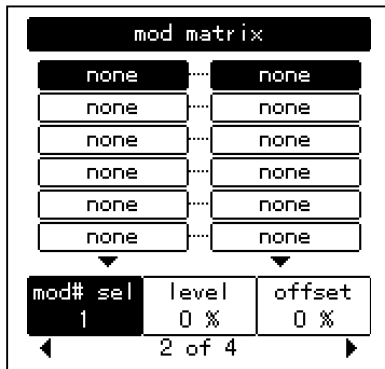

## Mod Matrix Parameter Descriptions

The parameters are listed by the parameter name, page number and the Soft button used to access them. Also listed is the default value for each parameter.

### Mod Select

**Pages:** 1, 2  
**Soft Button:** 1  
**Range:** 1-12  
**Default:** 1

This selects which of the 12 Mod routes you are editing.

*NOTE: There are several types of Mod Sources. Some, such as the Pitch and Mod Wheels are shared across all Voices in a Part. In some cases these Sources will be shared across multiple Parts. An example would be the case where two Parts are stacked on the keyboard and both use the local Pitch Wheel to modify their pitch. Other Sources, such as Envelopes and LFOs are unique to each Voice.*

## Mod Source

**Page:** 1  
**Soft Button:** 2  
**Range:** see table  
**Default:** "none"

Source	Description
None	No effect
Note-On Velocity	Velocity (how hard) the key is struck
Release Velocity	Velocity that the key is released.
Key Track	MIDI Key # used as modulator. MIDI note #60 is equivalent to 0.
M1 Wheel	Position Value of M1 Wheel, or incoming MIDI CC#00 message.
M2 Wheel	Position value of M2 wheel, or incoming MIDI CC as assigned
P Wheel	Position value of P wheel, or incoming MIDI Pitch Bend messages
Sustain Pedal	Position (Up/Down) of Sustain pedal, or incoming MIDI CC#64 messages
Expression Pedal	Position value of Exp pedal, or incoming MIDI CC as assigned
Amp Env Level	Amp Envelope Level
Filter Env Level	Filter Env Level
Pitch/Mod Env Level	Pitch/Mod Env Level
LFO 1 Sine	LFO 1 Sine output
LFO 1 Cosine	LFO 1 Sine output, phase shifted 90 degrees
LFO 1 Triangle	LFO 1 Triangle output
LFO 1 Cos-Triangle	LFO 1 Triangle output, phase shifted 90 degrees
LFO 2 Saw	LFO 1 Saw output
LFO 2 Cos-Saw	LFO 1 Saw output, phase shifted 90 degrees
LFO 1 Square	LFO 1 Square output
LFO 1 Cos-Square	LFO 1 Square output, phase shifted 90 degrees
LFO 2 Sine	LFO 1 Sine output
LFO 2 Cosine	LFO 1 Sine output, phase shifted 90 degrees
LFO 2 Triangle	LFO 1 Sine output
LFO 2 Cos-Triangle	LFO 1 Sine output, phase shifted 90 degrees
LFO 2 Saw	LFO 1 Sine output
LFO 2 Cos-Saw	LFO 1 Sine output, phase shifted 90 degrees
LFO 2 Square	LFO 1 Sine output
LFO 2 Cos-Square	LFO 1 Sine output, phase shifted 90 degrees
S&H Output	Output of the Sample and Hold processor.
Voice Random	Random modulation source, unique to each voice
Global Random	Random modulation Source, common to all voices
Portamento Level	Level of Portamento output, as a percentage of the "glide" travel from starting note to ending note.
Portamento Effect	Portamento Level scaled by keyboard position, so that the modulation level follows the note's pitch.
Tracking Generator	Output of Tracking Generator, Interpolated
Step Track	Output of Tracking Generator, Stepped
MIDI Channel Pressure	Monophonic (per-MIDI Channel) Aftertouch, MIDI only
MIDI Aftertouch	Polyphonic (per-note) Aftertouch, MIDI only
MIDI CC 1...119	Value of incoming MIDI Continuous Controller messages

## Mod Destination

**Page:** 1  
**Soft Button:** 3  
**Range:** see table  
**Default:** "none"

Note that while the majority of the Mod Destinations are Program parameters that show up in the Edit screens, there are a few special destinations that are unique to the Mod Matrix.

Destination	Description	
None	No effect.	
Voice Pitch	Modulates pitch of all three oscillators	
Osc 1 Pitch Full	Modulates oscillator pitch through entire 10 octave range	
Osc 2 Pitch Full		
Osc 3 Pitch Full		
Osc 1 Pitch Narrow	Modulates oscillator pitch, constrained to 1 octave	
Osc 2 Pitch Narrow		
Osc 3 Pitch Narrow		
Osc 1 Shape	<i>See equivalent Program Parameters</i>	
Osc 2 Shape		
Osc 3 Shape		
Osc FM Level		
Osc 1 Level		
Osc 2 Level		
Osc 3 Level		
Ring Mod Level		
Noise Level		
Ext In Level		
Osc 1 Balance		
Osc 2 Balance		
Osc 3 Balance		
Ring Mod Balance		
Noise Balance		
Ext In Balance		
F1 -> F2 Level		
Portamento Rate		
Unison Detune		
Filter 1 Freq		
Filter 1 Res		
Filter 1 Env Mod		
Filter 1 Keytrack		
Filter 2 Freq		
Filter 2 Res		
Filter 2 Env Mod		
Filter 2 Keytrack		
LFO 1 Rate		
LFO 1 Amplitude		Scales the amplitude of LFO 1's output - thus affecting the amount that the LFO can modulate anything else.
LFO 2 Rate		<i>See equivalent Program Parameter</i>
LFO 2 Amplitude		Scales the amplitude of LFO 2's output - thus affecting the amount that the LFO can modulate anything else.
S&H Rate		<i>See equivalent Program Parameter</i>
S&H Smoothing		
S&H Amplitude	Scales the amplitude of the S&H output - thus affecting the amount that the S&H can modulate anything else.	

<b>Filter 1 Level</b>	<i>See equivalent Program Parameters</i>
<b>Filter 2 Level</b>	
<b>Pre-Filter Level</b>	
<b>Filter 1 Pan</b>	
<b>Filter 2 Pan</b>	
<b>Pre-Filter Pan</b>	
<b>Drive Level</b>	
<b>Program Level</b>	Program output level
<b>Main/Aux Balance</b>	<i>See equivalent Part parameters</i>
<b>Pan</b>	
<b>Amp Env Amplitude</b>	Scales the amplitude of the envelope's output - thus affecting the amount that the envelope modulates anything else.
<b>Amp Env Rate</b>	Modulates all of the envelope time stages - Attack, Decay, Sustain and Release - simultaneously.
<b>Amp Env Attack</b>	<i>See equivalent Program Parameters</i>
<b>Amp Env Decay</b>	
<b>Amp Env Sust Time</b>	
<b>Amp Env Sust Level</b>	
<b>Amp Env Release</b>	
<b>Filter Env Amplitude</b>	Scales the amplitude of the envelope's output - thus affecting the amount that the envelope modulates anything else.
<b>Filter Env Rate</b>	Modulates all of the envelope time stages - Attack, Decay, Sustain and Release - simultaneously.
<b>Filter Env Attack</b>	<i>See equivalent Program Parameters</i>
<b>Filter Env Decay</b>	
<b>Filter Env Sust Time</b>	
<b>Filter Env Sust Level</b>	
<b>Filter Env Release</b>	
<b>P/M Env Amplitude</b>	Scales the amplitude of the envelope's output - thus affecting the amount that the envelope modulates anything else.
<b>P/M Env Rate</b>	Modulates all of the envelope time stages - Attack, Decay, Sustain and Release - simultaneously.
<b>P/M Env Attack</b>	<i>See equivalent Program Parameters</i>
<b>P/M Env Decay</b>	
<b>P/M Env Sust Time</b>	
<b>P/M Env Sust Level</b>	
<b>P/M Env Release</b>	
<b>Effects Level</b>	<i>See Effects Parameters</i>
<b>Effects Mix</b>	
<b>Effects Parameter A</b>	
<b>Effects Parameter B</b>	
<b>Effects Parameter C</b>	
<b>Effects Parameter D</b>	

## Mod Level

**Page:** 2  
**Soft Button:** 2  
**Range:** -100% - +100%  
**Default:** 0%

This parameter determines how much the Source will affect the destination.

## Mod Offset

**Page:** 2  
**Soft Button:** 3  
**Range:** -100% - +100%  
**Default:** 0%

This is a fixed offset added to the Destination value. It can be used to fine-tune the range of the modulation.



## Tracking Generator

The Tracking Generator is a special feature of the Mod Matrix. It is used to achieve more complex or precise modulations by taking an input signal (Mod Source) and re-mapping it. The input signal's amplitude is represented as 31 (or 24) points from -100% to zero to +100%. These points are assigned new levels from -100% to +100%. The output of the Tracking Generator shows up in the Mod Matrix as two sources: **Track Gen** – a smooth, continuous curve interpolated from the tracking points, and **Step Track** – which steps discretely from point to point.

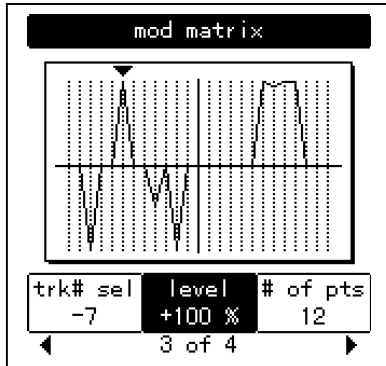

## Tracking Point

**Page:** 3  
**Soft Button:** 1  
**Range:** -12 to +12 (12 points), or -16 to +16 (16 points)  
**Default:** 0

This selects which Tracking Point – representing the input signal level – is being re-mapped.

## Level

**Page:** 3  
**Soft Button:** 2  
**Range:** -100% to +100%  
**Default:** 0%

This is the output to which the input signal is re-mapped.

## # of Points

**Page:** 3  
**Soft Button:** 3  
**Range:** 12 or 16  
**Default:** 16

The input to the Tracking Generator is quantized to either 12 or 16 points above and below 0.



## Tracking Input

**Page:** 4  
**Soft Button:** 1  
**Range:** see table  
**Default:** m2 wheel

Source	Description
None	No effect
Note-On Velocity	Velocity (how hard) the key is struck
Release Velocity	Velocity that the key is released.
Key Track	MIDI Key # used as modulator. MIDI note #60 is equivalent to 0.
M1 Wheel	Position Value of M1 Wheel, or incoming MIDI CC#00 message.
M2 Wheel	Position value of M2 wheel, or incoming MIDI CC as assigned
P Wheel	Position value of P wheel, or incoming MIDI Pitch Bend messages
Sustain Pedal	Position (Up/Down) of Sustain pedal, or incoming MIDI CC#64 messages
Expression Pedal	Position value of Exp pedal, or incoming MIDI CC as assigned
Amp Env Level	Amp Envelope Level
Filter Env Level	Filter Env Level
Pitch/Mod Env Level	Pitch/Mod Env Level
LFO 1 Sine	LFO 1 Sine output
LFO 1 Cosine	LFO 1 Sine output, phase shifted 90 degrees
LFO 1 Triangle	LFO 1 Triangle output
LFO 1 Cos-Triangle	LFO 1 Triangle output, phase shifted 90 degrees
LFO 1 Saw	LFO 1 Saw output
LFO 1 Cos-Saw	LFO 1 Saw output, phase shifted 90 degrees
LFO 1 Square	LFO 1 Square output
LFO 1 Cos-Square	LFO 1 Square output, phase shifted 90 degrees
LFO 2 Sine	LFO 1 Sine output
LFO 2 Cosine	LFO 1 Sine output, phase shifted 90 degrees
LFO 2 Triangle	LFO 1 Sine output
LFO 2 Cos-Triangle	LFO 1 Sine output, phase shifted 90 degrees
LFO 2 Square	LFO 1 Sine output
LFO 2 Cos-Square	LFO 1 Sine output, phase shifted 90 degrees
LFO 2 Saw	LFO 1 Sine output
LFO 2 Cos-Saw	LFO 1 Sine output, phase shifted 90 degrees
S&H Output	Output of the Sample and Hold processor.
Voice Random	Random modulation source, unique to each voice
Global Random	Random modulation Source, common to all voices
Portamento Level	Level of Portamento output, as a percentage of the "glide" travel from starting note to ending note.
Portamento Effect	Portamento Level scaled by keyboard position, so that the modulation level follows the note's pitch.
MIDI Channel Pressure	Monophonic (per-MIDI Channel) Aftertouch, MIDI only
MIDI Aftertouch	Polyphonic (per-note) Aftertouch, MIDI only
MIDI CC 1...119	Value of incoming MIDI Continuous Controller messages

This page intentionally left blank.

## Master Effects

In addition to the Drive Effects, which are unique to each Part, the Ion has a Master Effects Processor that is shared across all of the Parts. All Effects parameters are stored with individual Programs. Because there is only one, shared effects processor, the Program assigned to Part A will determine which Effect Type and settings are used for all Programs.

Effect parameters A-D show up in the Mod Matrix as Destinations. Because there is only one active effects program, but up to 8 voices playing at once, one must be very careful when assigning mod Sources. Sources that are unique to each voice such as - the Amp Envelope - can lead to unpredictable results. Global sources, such as the **(exp pedal)** and the **(m)** wheels are recommended.

*NOTE: Although only [the Program assigned to] Part A's effects are active (audible), the effects parameters for all four Parts can be edited.*

## Effect Type

**Page:** 1  
**Soft Button:** 1  
**Range:** see the next section, “Effect Types”  
**Default:** bypass

Several different effects are available, each with a different selection of adjustable parameters. A list of the Types follows in the next section, “Effect Types”.

## Effect Mix

**Page:** 1  
**Soft Button:** 2  
**Range:** 100% dry – 50-50% - 100% wet  
**Default:** 50-50%

This mixes between the “wet” effected signal, and the “dry” pre-effects signal. The value ranges from 100% dry - indicating no Effect at all – to 50-50% - an equal mix of wet and dry signals – to 100% wet.

## Parameters A-F

**Pages:** 1-3  
**Soft Button:** n/a  
**Range:** various  
**Default:** various

These parameters will vary depending on the Effect Type selected. Refer to the descriptions in the next section.

## Effect Types

### Bypass

No effect

## Super Phaser

The classic phaser effect is created by ganging multiple all-pass filter stages to create “notches,” or sharp dips in the frequency spectrum. The frequencies of these all-pass filters are usually modulated by an LFO to create a dramatic sweeping sound. The Super Phaser follows this classic formula but allows you to select from 4 to 64 all-pass stages for a wide variety of timbres.

### A. Feedback

This is the amount of the phaser output added back into the input to produce a deeper effect.

**Range:** -100% to 0 to +100%

### B. Notch Freq

This is the frequency of the first (lowest) notch, un-modulated by the LFO.

**Range:** 0 – 100%

### C. LFO Rate

This is the rate of the Low Frequency Oscillator.

**Range:** 0.010Hz – 4.800Hz, or 1/16 to 16 if Tempo Sync is enabled

### D. LFO Depth

This adjusts the magnitude of the LFO modulation. When set to 0%, the LFO has no effect on the notch frequencies.

**Range:** 0 – 100%

### E. LFO Shape

This selects between the two LFO shapes.

**Range:** Tri, Sin

### F. Stages

This selects how many all-pass filter stages, and thus notches are used.

**Range:** 4, 8, 16, 32, 48, 64

### G. Tempo Sync

This selects whether the LFO rate is synchronized to the System Tempo. When enabled, the LFO Rate parameter is displayed as a multiple of the Tempo.

**Range:** On, Off

## String Phaser

This effect is based on the phaser built into a classic analog string synthesizer. It has 14 stages, and uses combination of positive and negative feedback to produce a rich and complex sound.

### A. Feedback

This is the amount of the phaser output added back into the input to produce a deeper effect.

**Range:** 0 - 100%

### B. Notch Freq

This is the frequency of the first (lowest) notch, un-modulated by the LFO.

**Range:** 0 – 100%

### C. LFO Rate

This is the rate of the Low Frequency Oscillator.

**Range:** 0.010Hz – 4.800Hz, or 1/16 to 16 if Tempo Sync is enabled

### D. LFO Depth

This adjusts the magnitude of the LFO modulation. When set to 0%, the LFO has no effect on the notch frequencies.

**Range:** 0 – 100%

### E. LFO Shape

This selects between the two LFO shapes.

**Range:** Tri, Sin

### F. Tempo Sync

This selects whether the LFO rate is synchronized to the System Tempo. When enabled, the LFO Rate parameter is displayed as a multiple of the Tempo.

**Range:** On, Off

## Theta Flanger

The Theta Flanger is a combination of phaser and flanger effects. The input is filtered through a 32-stage phaser, and then fed to the input of a flanger. The sound is very interesting and musical.

### A. Feedback

This is the amount of the flanger output added back into the input to produce a deeper effect.

**Range:** 0 - 100%

### B. Manual Delay

This is the base delay time that is modulated by the LFO to create the Flange effect. It determines the frequencies of the notches and peaks.

**Range:** 0 – 100%

### C. LFO Rate

This is the rate of the Low Frequency Oscillator.

**Range:** 0.010Hz – 4.800Hz, or 1/16 to 16 if Tempo Sync is enabled

### D. LFO Depth

This adjusts the magnitude of the LFO modulation. When set to 0%, the LFO has no effect on the notch frequencies.

**Range:** 0 – 100%

### E. LFO Shape

This selects between the two LFO shapes.

**Range:** Tri, Sin

### F. Tempo Sync

This selects whether the LFO rate is synchronized to the System Tempo. When enabled, the LFO Rate parameter is displayed as a multiple of the Tempo.

**Range:** On, Off

## Thru Zero Flanger

A Flange effect using two delay lines (per stereo side) to emulate the classic flange effect produced using two analog tape machines. Because there are two delay lines in constant motion, the delay time can fall through zero to become negative. This has a unique sound that can't be replicated with a standard, single-delay flanger.

### A. Feedback

This is the amount of the flanger output added back into the input to produce a deeper effect.

**Range:** 0 - 100%

### B. Manual Delay

This is the base delay time that is modulated by the LFO to create the Flange effect. It determines the frequencies of the notches and peaks.

**Range:** 0 – 100%

### C. LFO Rate

This is the rate of the Low Frequency Oscillator.

**Range:** 0.010Hz – 4.800Hz, or 1/16 to 16 if Tempo Sync is enabled

### D. LFO Depth

This adjusts the magnitude of the LFO modulation. When set to 0%, the LFO has no effect on the notch frequencies.

**Range:** 0 – 100%

### E. LFO Shape

This selects between the two LFO shapes.

**Range:** Tri, Sin

### F. Tempo Sync

This selects whether the LFO rate is synchronized to the System Tempo. When enabled, the LFO Rate parameter is displayed as a multiple of the Tempo.

**Range:** On, Off

## Chorus

A chorus effect uses an LFO to modulate the pitch of the input signal, which is then added back to the dry signal. In small doses this will create the illusion of multiple voices playing at once. Turn up the Feedback and Depth for more pronounced “shimmering” and “watery” sounds.

### A. Feedback

This is the amount of the chorus output added back into the input to produce a deeper effect.

**Range:** 0 - 100%

### B. Manual Delay

This is the base delay time that is modulated by the LFO to create the Flange effect. It determines the frequencies of the notches and peaks.

**Range:** 0 – 100%

### C. LFO Rate

This is the rate of the Low Frequency Oscillator.

**Range:** 0.010Hz – 4.800Hz, or 1/16 to 16 if Tempo Sync is enabled

### D. LFO Depth

This adjusts the magnitude of the LFO modulation. When set to 0%, the LFO has no effect on the notch frequencies.

**Range:** 0 – 100%

### E. LFO Shape

This selects between the two LFO shapes.

**Range:** Tri, Sin

### F. Tempo Sync

This selects whether the LFO rate is synchronized to the System Tempo. When enabled, the LFO Rate parameter is displayed as a multiple of the Tempo.

**Range:** On, Off



## 40-Band Vocoder

A vocoder uses two sets of band-pass filters (filter banks) to impart the characteristics of one sound source onto another. The **analysis** filter bank determines the level of the input at several different frequencies. These levels are used to modulate the output levels of the corresponding frequencies of the **synthesis** filter bank. The most common use of this is to send a synthesizer signal into the synthesis input and a voice (recorded or live via a microphone) into the analysis input to get a “talking synthesizer” effect.

### A. Analysis Sensitivity

This adjusts the gain of the input to the analysis filter bank.

**Range:** -100% - +100%

### B. Sibilance Boost

This adjusts the level of a high-pass shelving filter at the input to the analysis filter bank. This will increase or decrease the sibilant frequencies (consonant sounds) to improve intelligibility or change the tonality of the vocoder.

**Range:** -100% - +100%

### C. Decay

This adjusts how quickly the synthesis filters will react to the input signal. A faster response (lower setting) will usually be more intelligible, but slower decay times (higher setting) can be more musical.

**Range:** 0 - 100%

### D. Band Shift

This shifts the frequencies of the Synthesis filter bank, relative to the analysis filters. The result is a pseudo pitch-shift effect.

**Range:** -100% - +100%

### E. Synthesis Signal

This selects which signal is sent to the synthesis filter bank.

**Range:** Effects Send, Aux Bus, Ext In Left, Ext In Stereo

### F. Analysis Signal

This selects which signal is sent to the analysis filter bank.

**Range:** Effects Send, Aux Bus, Ext In Right, Ext In Stereo

### G. Analysis Mix

This adjusts how much of the analysis signal is mixed into the output.

**Range:** 0 - 100%

This page intentionally left blank.

## What is MIDI?

MIDI is the communication standard for electronic musical instruments. You can use MIDI to:

- Record what you play on your Ion synthesizer into a sequencer or computer.
- Play back sequences from a sequencer or computer on your Ion.
- Store and recall Programs and Setups on a computer.
- Use a computer to edit your Ion's sounds.
- Use your Ion to control another synthesizer or sound module.
- Use another keyboard to play your Ion's sounds.

Some examples of MIDI devices besides your Ion synthesizer include keyboard controllers, sound modules, drum machines, sequencers, and computers with MIDI interfaces.

## MIDI Connections

The Ion has three MIDI connectors:

- [MIDI IN] is for receiving MIDI information from another MIDI device.
- [MIDI OUT] is for sending MIDI information to another device. Depending on your settings, the data from this port can originate from the Ion itself or simply be echoed from the [MIDI IN] port.
- [MIDI THRU] echoes whatever is received on the [MIDI IN] port.

Here are four typical MIDI setups for your Ion, and the appropriate connections for each of them:

- **Controller.** With this setup, you can use your Ion to “play” another MIDI instrument (synthesizer, sound module, drum machine etc.). Connect a MIDI cable from the Ion's [MIDI OUT] jack to the MIDI IN of the device you want to control.

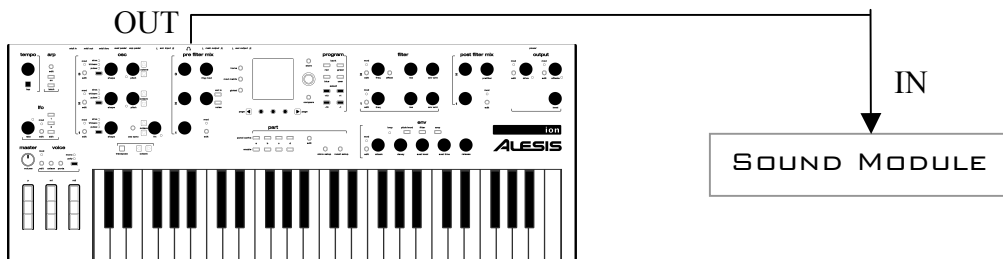

- **Slave.** With this setup, you can use another keyboard to play the sounds on your Ion. Connect a MIDI cable from the controller's MIDI OUT jack to the Ion's [MIDI IN] jack.

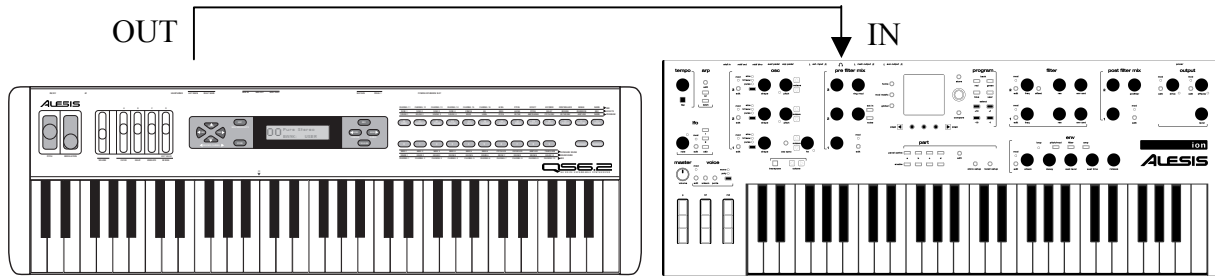

- **Slave with pass-through.** This setup allows MIDI signals to pass through the Ion so they may reach multiple units. This allows one MIDI device to control several. Attach a cable from the MIDI OUT of the first device to the [MIDI IN] jack of the Ion; and then attach another cable from the Ion's [MIDI THRU] jack to the MIDI IN of the third device.

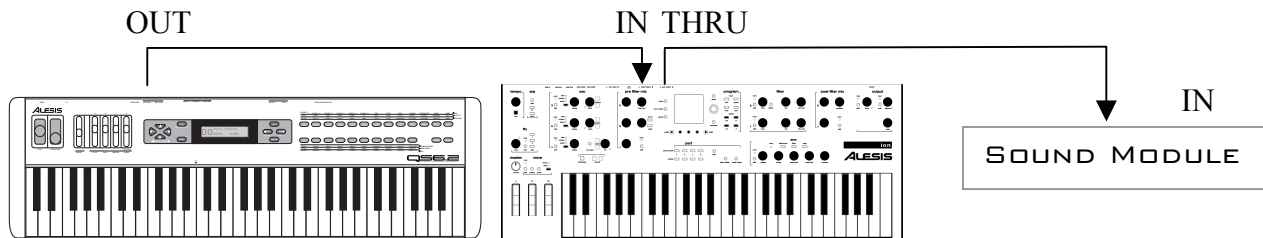

- **Sequencing.** This setup allows you to use your Ion with a MIDI sequencer or a computer with a MIDI interface. Attach one MIDI cable from the MIDI OUT of the sequencer or computer to the [MIDI IN] jack of the Ion. Attach another cable from the Ion's [MIDI OUT] jack to the MIDI IN of the sequencer or computer.

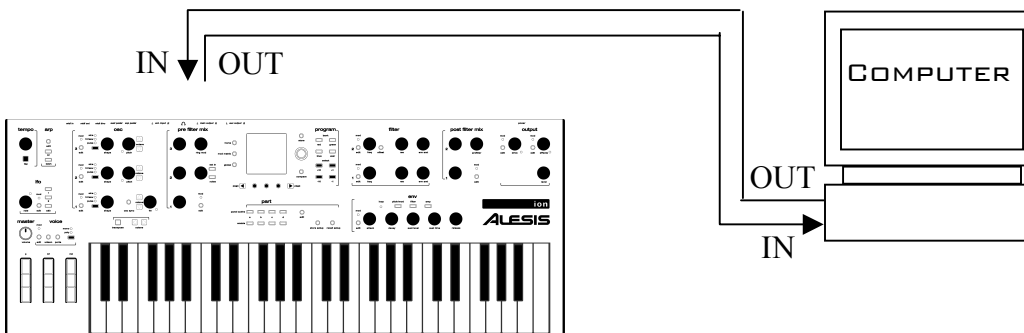

## Using Your Ion With a MIDI Sequencer

A **sequencer** is a device that records and plays back note messages. A sequencer can take the form of a stand-alone hardware device, or a computer with a MIDI interface and sequencing software.

Using a MIDI sequencer, you can record what you play on your Ion, and then play it back later.

## Changing the MIDI Channel

In order for MIDI to work, the MIDI Channel must be set properly. For example, if you want one device to control another via MIDI, they must be set to the same MIDI channel. There are 16 MIDI channels.

In the Home Screen, you can see which MIDI channel the active Part is set to in the lower Right hand corner.

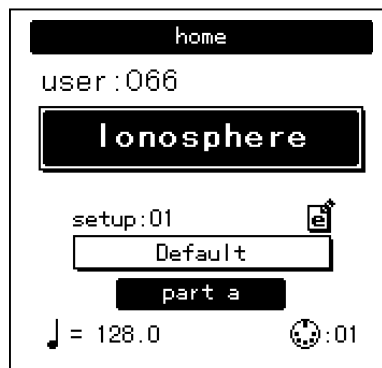

To change a Part's MIDI channel, press the **[part edit]** button. The third Soft Button corresponds to the **midi channel** parameter.

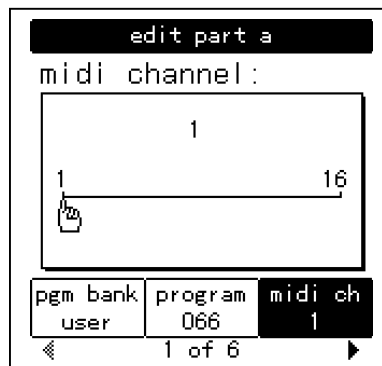

## Local vs. MIDI Control

When using the Ion with a sequencer, it is best to disable **local control** of the keyboard. This disconnects the keyboard of the Ion from the internal sound engine. A sequencer will usually “echo” the MIDI data at its input back to its output. If local control is enabled, you can get double-triggered notes – one note played on the keyboard and the same note sent back to the MIDI input.

To disable local control on the Ion, press **[part edit]**, then navigate to page 2. The first Soft Button selects the **midi/local** parameter. Set this to “**midi only**”.

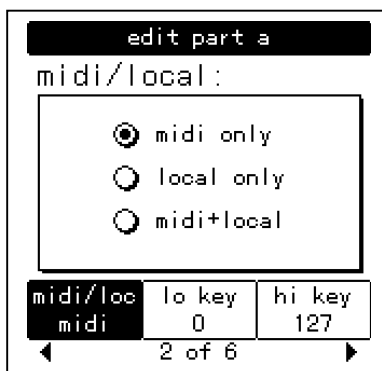

## Saving Programs and Setups via MIDI

The Ion lets you transmit Programs - individually, or a Bank at a time - to an external device (such as a computer, sequencer, storage device, or another Ion synthesizer) via MIDI.

### To send a Program via MIDI:

1. Press the **[store]** button, then the Right **[page]** button.
2. Press the Left Soft Button and use the Encoder to select which Program you want to send.
3. By default, the destination will be the same as the Program you are sending. You can change this though, and it may be useful if you are sending a Program to another Ion. Press the middle Soft Button and use the Encoder to select what the destination will be.
4. When you have selected the “from” and “to” locations, press the **[store]** button to send the Program.

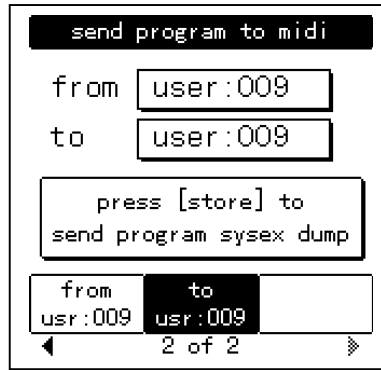

*NOTE: By default, the Red, Blue and Green banks of the Ion are write-protected. You will not be able to store to these Banks, or receive Programs to them via MIDI. You can disable the write protect feature by pressing **[global]** and navigating to page 6.*

### To send an entire Bank of Programs via MIDI:

1. Press the **[store]** button, then the Right **[page]** button.
2. Press the Left Soft Button and turn the Encoder through the Program numbers until it says “all” (between 127 and 0).
3. Use the top panel **[bank]** buttons to select the Bank you wish to send.
4. You may select a destination Bank that is different from the one that you are sending
5. Press the **[store]** button to send the Program Bank.



**To send a single Setup via MIDI:**

1. Press the **[store setup]** button, then the Right **[page]** button.
2. Press the Left Soft Button and use the Encoder to select the Setup you want to send.
3. Use the top panel **[bank]** buttons to select the Bank you wish to send.
4. You may select a destination Setup that is different from the one that you are sending by pressing the middle Soft Button.
5. Press the **[store]** button to send the Setup.

**To send all Setups via MIDI:**

1. Press the **[store setup]** button, then the Right **[page]** button.
2. Press the Left Soft Button and turn the Encoder through the Setup numbers until it says "all".
3. Use the top panel **[bank]** buttons to select the Bank you wish to send.
4. Press the **[store]** button to send the Setups.

**Loading Programs and Setups via MIDI**

The Ion doesn't need to be in a special mode to receive MIDI sysex information. Simply connect a MIDI cable from the MIDI out jack of your MIDI player to the [MIDI IN] port of your Ion and start the sysex dump on your MIDI storage device or computer. If everything is working properly, the Ion display will read "RECEIVING MIDI DATA..." and the Bank, Program, or Setup will be loaded.

*NOTE: Some computers are not fast enough to transmit MIDI sysex data properly. If you are experiencing problems, try adjusting the settings in your MIDI software. Some programs allow you to slow down the transmit rate so the computer hardware can keep up with the software.*



## Updating Software Via MIDI

The Ion's operating system software is upgradeable via MIDI. From time to time Alesis will release updates, which will add or enhance features. Software updates will be posted to the Alesis website.

In order to upgrade the Ion's software, you will need a computer with a MIDI interface and MIDI sequencing software.

### To Upgrade the Software in your Ion:

1. Connect the MIDI OUT of the computer to the MIDI IN of the Ion.
2. Open the ".syx" software file in your sequencer program.
3. Turn the Ion's power on while holding both the **[panel active a]** and **[panel active d]** buttons.
4. The display will read "**do you want to upgrade software via midi?**"
5. Press the Left Soft Button, marked "yes".
6. Play the ".syx" file.
7. The Ion will display the status of the update. After it has finished, it will reboot itself.

## Sending and Receiving Bank Select Messages

The MIDI Specification defines two Bank Select messages – CC00 is Bank Select MSB and CC32 is Bank Select LSB. In practice, most manufacturers have chosen to use only one of these messages. The Ion can be set to send and respond to either CC00 or CC32. This parameter is found in Global Edit on Page 3.

## All Notes Off

The MIDI command **All Notes Off** is used to silence a synthesizer with a note or notes that are stuck on. This is usually caused when a Note On message is received without a Note Off. The Ion responds to the All Notes Off message, and can also send it. Press the **[home]** button twice in quick succession (double-click) to send All Notes Off.

## MIDI Controller Numbers

Each type of controller has its own MIDI controller number. Not all controller numbers have been standardized for specific functions, but the following indicates the current list of assigned controllers.

#	Function
0	Bank Select
1	Modulation Wheel
2	Breath Controller
3	Early DX7 Aftertouch
4	Foot Controller
5	Portamento Time
6	Data Slider
7	Main Volume
8	Balance
10	Pan
11	Expression
16	General Purpose #1
17	General Purpose #2
18	General Purpose #3
19	General Purpose #4
32-63	Least Significant Bits (LSB), Controllers 0-31
64	Sustain Pedal
65	Portamento On/Off
66	Sostenuto Pedal
67	Soft Pedal
69	Hold 2
80	General Purpose #5
81	General Purpose #6
82	General Purpose #7
83	General Purpose #8
91	Reverb Depth
92	Tremolo Depth
93	Chorus Depth
94	Celeste Depth
95	Phase Depth
96	Data Increment
97	Data Decrement
98	Non-Registered Parameter MSB
99	Non-Registered Parameter LSB
100	Registered Parameter MSB
101	Registered Parameter LSB
121	Reset All Controllers
122	Local Control On/Off
123	All Notes Off
124	Omni Off
125	Omni On
126	Mono On
127	Poly On

## MIDI Implementation Chart

Function		Transmitted	Recognized	Remarks
Basic Channel	Default	1 — 16	1 — 16	Memorized
	Changed	1 — 16 each	1 — 16 each	
Mode	Default	Mode 3	Mode 3	
	Messages Altered	X * * * * * * * *	X	
Note Number		0 — 127	0 — 127	
	True Voice	* * * * * * * *	0 — 127	
Velocity	Note On	O	O	
	Note Off	O	O	
After Touch	Keys	X	O	
	Ch's	O <sup>1</sup>	O	
Pitch Bender		O	O	
Control Change		0 — 120	O	
Prog Change		O 0 — 127	O 0 — 127	
	True #	* * * * * * * *	0 — 127	
System Exclusive		O	O	
System Common	Song Pos	X	X	
	Song Sel	X	X	
	Tune	O	O	
System Realtime	Clock	O	O	
	Commands	X	X	
Aux Messages	Local On/Off	X	O <sup>2</sup>	
	All Notes Off	X	O	
	Active Sense	X	X	
	Reset	X	O <sup>2</sup>	
	GM On	X	X	
Notes :		<sup>1</sup> Sent via wheels or exp pedal, not keyboard		
		<sup>2</sup> Recognized as ALL NOTES OFF		

Mode 1: OMNI ON, POLY  
Mode 1: OMNI ON, MONO

Mode 3: OMNI OFF, POLY  
Mode 4: OMNI OFF, MONO

O : Yes  
X : No

This page intentionally left blank.

## How do I split/layer the keyboard?

It is not uncommon to want to “split” a keyboard so that different ranges are playing different sounds. An example would be a bass sound for the Left hand and a lead sound for the Right hand. Similarly, it is often desirable to layer or “stack” multiple sounds onto the same key(s). An example of this would be layering multiple brass or string sounds to emulate a brass (or string) “section”.

Each of the Ion’s 4 Parts can be assigned to any range on the keyboard. They can overlap to create layers or you can assign them to exclusive zones to create splits.

### To Set a Part’s Range:

1. Press the **[part edit]** button, and navigate to page 2.
2. Press the middle Soft Button, and use the Encoder to select the lowest note you want the Part to play. You can also HOLD the middle soft button and press the key on the keyboard.
3. Press the Right Soft Button, and use the Encoder to select the highest note you want the Part to play. You can also HOLD the Right soft button and press the key on the keyboard.
4. Repeat for other Parts, and then store.

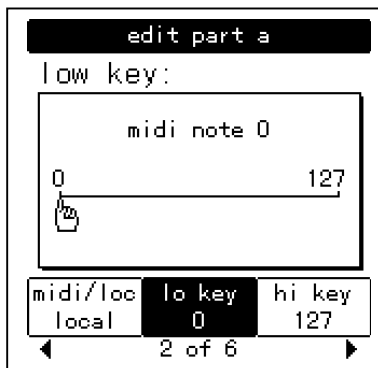

## What is a MIDI Sequence?

A MIDI sequence is a data file containing note data that can be played on a MIDI synthesizer like the Ion. A General MIDI sequence is a sequence that will play on any General-MIDI compatible synthesizer (like the Ion) with the correct sounds, regardless of the brand of synthesizer.

## Where can I get more Banks?

Additional Program Banks will be available on the Alesis website free of charge. See the chapter 8 “MIDI” for more information on how to load the additional Programs into your Ion.

## Are Ion Programs compatible with Andromeda programs?

No, sorry. The A6 Andromeda is a true analog synthesizer, while the Ion is an analog *modeling* synthesizer. They have completely different circuitry.

## How do I change what the (m2) wheel does?

You can assign the M2 (or M1) wheel to control a huge selection of parameters via the Mod Matrix. See Chapter 6 “The Mod Matrix” for information.



## Frequently Asked Questions

This page intentionally left blank.

If you experience problems while operating your Ion, please use the following table to check for possible causes and solutions *before* contacting Alesis customer service for assistance.

Symptoms	Cause	Solution
The display does not light up when the ON/OFF switch is turned on.	No power.	Check that the power cable is plugged in properly.
No sound.	Bad Connections.	Check your audio cables; if necessary, swap cables.
	Master Volume is turned down.	Raise the <b>Master Volume</b> knob or Exp pedal.
	Part Output Level is turned down.	Raise Part Output Level. (Part Edit, page 3)
	Part is Disabled.	Press <b>[part enable]</b> buttons.
	Local keyboard is disabled.	Set to Local + MIDI or Local Only. (Part Edit, page 2)
	External MIDI device sent Volume (CC#7) or Expression (CC#11) commands with a value approaching 0.	Change Setups, to revert to default values. Re-transmit higher values from MIDI device.
Notes sustain continuously.	Sustain pedal was plugged in after power was turned on.	Turn the unit's power off, wait a moment, and then turn it on again.
	Stuck notes due to incomplete MIDI data.	Press the <b>[home]</b> button twice quickly (double-click).
Notes played from Ion have a "doubled" or "flanged" sound	MIDI echo/Thru enabled on external MIDI device or computer	Disable MIDI echo/Thru on external MIDI device Put Ion into MIDI Only mode (Part Edit, page 2)
All Programs and Setups have the same Tempo setting.	Global tempo source set to Global	Change Global tempo source to Program (Global edit page 3, Soft button 2)

## Recovering from a Crash

If your Ion behaves erratically or “freezes” on you, turn it off, wait for a moment, and then turn it on again. Make sure you turn off any amplification first!

If your instrument still isn't working after that, then disconnect the [MIDI IN] cable and repeat the power on/off trick. This ought to work if your problem is being caused by strange MIDI data coming from an external MIDI device.

## Checking the Software Version

To find out what version of the operating system software is currently installed in your Ion, hold down **[panel active a]** and **[panel active d]** at the same time and turn the Ion off, then on.

## Cleaning Your Ion

Before doing cleaning of any kind, always disconnect the AC cord.

For simple dusting and removal of minor dirt, wipe the instrument down with a slightly damp cloth.

For heavy dirt, use a non-abrasive household cleaner such as Formula 409 or Fantastik. Spray the cleanser onto a cloth, then use the cloth to clean the unit.



*NEVER spray any cleaner directly onto the Ion — this can destroy the lubricants used in the switches and controls!*



# Specifications

## Sound Engine

<b>Sound Generation:</b>	Alesis proprietary DSP Analog Modeling
<b>Polyphonic Voices:</b>	8, each with 3 oscillators, 2 multi-mode filters, 3 envelope generators, 2 LFOs, programmable effects send and modulation matrix.
<b>Program Memory:</b>	512 Preset Programs, 32 Multi-timbral Setups, all user-rewritable
<b>Effects:</b>	4 Drive Effects (1 each per Part) plus Master Effects (Shared)

## Audio Input

<b>Input Connectors:</b>	2 Balanced 1/4" TRS jacks
<b>Maximum Input Level:</b>	+5.2dBu (1.41VRMS) = -0dBFS
<b>Input Impedance:</b>	10k $\Omega$

## Audio Output

<b>Output Connectors:</b>	4 Impedance-Balanced 1/4" TRS jacks, 1/4" TRS Headphone Jack
<b>Maximum Output Level:</b>	+18dBu (6.17 VRMS) = -0dBFS
<b>Output Impedance:</b>	1k $\Omega$

## Audio Performance

<b>Signal To Noise Ratio:</b>	>95 dB A-weighted, Ext In to Main or Aux Out
<b>THD+N:</b>	< 0.005%, External In to Main or Aux Out
<b>Frequency Response:</b>	20-20kHz $\pm$ 0.20dB, External In to Main or Aux Out
<b>Power Consumption:</b>	12 Watts max (100-240VAC/50-60Hz)

*All measurements done over a 20Hz – 20kHz range with a 1kHz sine wave at -1dBFS input. Impedances are measured at 1kHz.*

## Physical

<b>Keyboard:</b>	49 keys (velocity, release velocity sensitive)
<b>Real-Time Controllers:</b>	30 360-degree Parameter Knobs, 2 Assignable Modulation Wheels, Assignable Pitch Wheel,
<b>Pedal Jacks:</b>	Assignable Exp pedal jack, Sustain pedal jack
<b>MIDI Connections:</b>	MIDI In, MIDI Out, MIDI Thru
<b>Audio Outputs:</b>	Main L/R, Aux L/R, Headphone (1/4" TRS)
<b>Dimensions (WxHxD):</b>	33.0" x 3.75" x 13.0" / 838.20 x 95.25 x 330.20mm
<b>Weight:</b>	20 lbs / 9 kg

## Index

This page intentionally left blank.

# Warranty / Contact Alesis

## Alesis Limited Warranty

ALESIS CORPORATION ("ALESIS") warrants this product to be free of defects in material and workmanship for a period of one (1) year for parts and for a period of one (1) year for labor from the date of original retail purchase. This warranty is enforceable only by the original retail purchaser and cannot be transferred or assigned.

The purchaser should complete and return the enclosed warranty card within 14 days of purchase. During the warranty period ALESIS shall, at its sole and absolute option, either repair or replace free of charge any product that proves to be defective on inspection by ALESIS or its authorized service representative. In all cases disputes concerning this warranty shall be resolved as prescribed by law.

To obtain warranty service, the purchaser must first call or write ALESIS at the address and telephone number printed below to obtain a Return Authorization Number and instructions concerning where to return the unit for service. All inquiries must be accompanied by a description of the problem. All authorized returns must be sent to ALESIS or an authorized ALESIS repair facility postage prepaid, insured and properly packaged. Proof of purchase must be presented in the form of a bill of sale, canceled check or some other positive proof that the product is within the warranty period. ALESIS reserves the right to update any unit returned for repair. ALESIS reserves the right to change or improve design of the product at any time without prior notice.

This warranty does not cover claims for damage due to abuse, neglect, alteration or attempted repair by unauthorized personnel, and is limited to failures arising during normal use that are due to defects in material or workmanship in the product.

THE ABOVE WARRANTIES ARE IN LIEU OF ANY OTHER WARRANTIES OR REPRESENTATIONS WHETHER EXPRESS OR IMPLIED OR OTHERWISE, WITH RESPECT TO THE PRODUCT, AND SPECIFICALLY EXCLUDE ANY IMPLIED WARRANTIES OF FITNESS FOR A PARTICULAR PURPOSE OR MERCHANTABILITY OR OTHER IMPLIED WARRANTIES. Some states do not allow limitations on how long an implied warranty lasts, so the above limitation may not apply to you.

IN NO EVENT WILL ALESIS BE LIABLE FOR INCIDENTAL, CONSEQUENTIAL, INDIRECT OR OTHER DAMAGES RESULTING FROM THE BREACH OF ANY EXPRESS OR IMPLIED WARRANTY, INCLUDING, AMONG OTHER THINGS, DAMAGE TO PROPERTY, DAMAGE BASED ON INCONVENIENCE OR ON LOSS OF USE OF THE PRODUCT, AND, TO THE EXTENT PERMITTED BY LAW, DAMAGES FOR PERSONAL INJURY. Some states do not allow the exclusion or limitation of incidental or consequential damages, so the above limitation or exclusion may not apply to you.

THIS CONTRACT SHALL BE GOVERNED BY THE INTERNAL LAWS OF THE STATE OF CALIFORNIA WITHOUT REFERENCE TO CONFLICTS OF LAWS. This warranty gives you specific legal rights, and you may also have other rights required by law which vary from state to state.

This warranty only applies to products sold to purchasers in the United States of America or Canada. The terms of this warranty and any obligations of Alesis under this warranty shall apply only within the country of sale. Without limiting the foregoing, repairs under this warranty shall be made only by a duly authorized Alesis service representative in the country of sale. For warranty information in all other countries please refer to your local distributor.

*For more effective service and product update notices, please register your Ion online at:*

*<http://www.alesis.com/support/warranty.htm>*

## Alesis Contact Information

Alesis Distribution, LLC  
Los Angeles, USA

E-mail: [support@alesis.com](mailto:support@alesis.com)  
Website: <http://www.alesis.com>

Alesis Ion Reference Manual  
Revision 1.0 by Randy Lee, Ben Ling, and Bret Victor

Copyright 2003, Alesis Distribution, LLC. All rights reserved  
Reproduction in whole or in part is prohibited. "Ion" is a trademark of Alesis Distribution, LLC. Specifications subject to change without notice.

7-51-0124-A  
4/25/2003